

**YAMAHA**

RHYTHM SOUND MODULE

**RM50**



**OWNER'S MANUAL**

## FCC INFORMATION (U.S.A.)

### 1. IMPORTANT NOTICE: DO NOT MODIFY THIS UNIT!

This product, when installed as indicated in the instructions contained in this manual, meets FCC requirements. Modifications not expressly approved by Yamaha may void your authority, granted by the FCC, to use the product.

### 2. IMPORTANT: When connecting this product to accessories and/or another product use only high quality shielded cables. Cable/s supplied with this product MUST be used. Follow all installation instructions. Failure to follow instructions could void your FCC authorization to use this product in the USA.

### 3. NOTE: This product has been tested and found to comply with the requirements listed in FCC Regulations, Part 15 for Class "B" digital devices. Compliance with these requirements provides a reasonable level of assurance that your use of this product in a residential environment will not result in harmful interference with other electronic devices. This equipment generates/uses radio frequencies and, if not installed and used according to the instructions found in the users manual, may cause interference harmful to the operation of other electronic devices. Compliance with FCC regulations does not guarantee that interference will not occur in all installations. If this product is found to be the source of interference, which can be determined by turning the unit "OFF" and "ON", please try to eliminate the problem by using one of the following measures:

Relocate either this product or the device that is being affected by the interference.

Utilize power outlets that are on different branch (circuit breaker or fuse) circuits or install AC line filter/s.

In the case of radio or TV interference, relocate/reorient the antenna. If the antenna lead-in is 300 ohm ribbon lead, change the lead-in to co-axial type cable.

If these corrective measures do not produce satisfactory results, please contact the local retailer authorized to distribute this type of product. If you can not locate the appropriate retailer, please contact Yamaha Corporation of America, Electronic Service Division, 6600 Orangethorpe Ave, Buena Park, CA 90620

\* This applies only to products distributed by YAMAHA CORPORATION OF AMERICA.

Dette apparat overholder det gældende EF-direktiv vedrørende radiostøj.

Cet appareil est conforme aux prescriptions de la directive communautaire 87/308/CEE.

Diese Geräte entsprechen der EG-Richtlinie 82/499/EWG und/oder 87/308/EWG.

This product complies with the radio frequency interference requirements of the Council Directive 82/499/EEC and/or 87/308/EEC.

Questo apparecchio è conforme al D.M.13 aprile 1989 (Direttiva CEE/87/308) sulla soppressione dei radio-disturbi.

Este producto está de acuerdo con los requisitos sobre interferencias de radio frecuencia fijados por el Consejo Directivo 87/308/CEE.

**YAMAHA CORPORATION**

## IMPORTANT NOTICE FOR THE UNITED KINGDOM

Connecting the Plug and Cord

**IMPORTANT**

**THE WIRES IN MAINS LEAD ARE COLOURED IN ACCORDANCE WITH THE FOLLOWING CODE:**

Blue: NEUTRAL

Brown: LIVE

As the colours of the wires in the mains lead of this apparatus may not correspond with the coloured markings identifying the terminals in your plug, proceed as follows: The wire which is coloured BLUE must be connected to the terminal which is marked with the letter N or coloured BLACK. The wire which is coloured BROWN must be connected to the terminal which is marked with the letter L or coloured RED.

Making sure that neither core is connected to the earth terminal of the three pin plug.

## CANADA

THIS DIGITAL APPARATUS DOES NOT EXCEED THE "CLASS B" LIMITS FOR RADIO NOISE EMISSIONS FROM DIGITAL APPARATUS SET OUT IN THE RADIO INTERFERENCE REGULATION OF THE CANADIAN DEPARTMENT OF COMMUNICATIONS.

LE PRESENT APPAREIL NUMERIQUE N'EMET PAS DE BRUITS RADIOELECTRIQUES DEPASSANT LES LIMITES APPLICABLES AUX APPAREILS NUMERIQUES DE LA "CLASSE B" PRESCRITES DANS LE REGLEMENT SUR LE BROUILLAGE RADIOELECTRIQUE EDICTE PAR LE MINISTERE DES COMMUNICATIONS DU CANADA.

\* This applies only to products distributed by YAMAHA CANADA MUSIC LTD.

Litiumbatteri!

Bör endast bytas av servicepersonal.

Explosionsfara vid felaktig hantering.

VAROITUS!

Lithiumparisto, Räjähdyksvaara.

Pariston saa vaihtaa ainoastaan alan ammattimies.

ADVARSEL!

Lithiumbatteri!

Ekspløsningsfare. Udskiftning må kun foretages

af en sagkyndig, - og som beskrevet i servicemanualen.

# SPECIAL MESSAGE SECTION

**PRODUCT SAFETY MARKINGS:** Yamaha electronic products may have either labels similar to the graphics shown below or molded/stamped facsimiles of these graphics on the enclosure. The explanation of these graphics appears on this page. Please observe all cautions indicated on this page and those indicated in the safety instruction section.

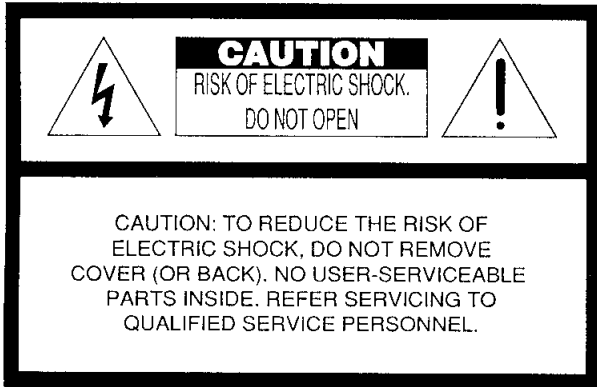

The exclamation point within the equilateral triangle is intended to alert the user to the presence of important operating and maintenance (servicing) instructions in the literature accompanying the product.

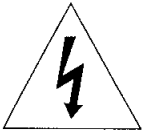

The lightning flash with arrowhead symbol within the equilateral triangle is intended to alert the user to the presence of uninsulated "dangerous voltage" within the product's enclosure that may be of sufficient magnitude to constitute a risk of electrical shock.

**IMPORTANT NOTICE:** All Yamaha electronic products are tested and approved by an independent safety testing laboratory in order that you may be sure that when it is properly installed and used in its normal and customary manner, all foreseeable risks have been eliminated. **DO NOT** modify this unit or commission others to do so unless specifically authorized by Yamaha. Product performance and/or safety standards may be diminished. Claims filed under the expressed warranty may be denied if the unit is/has been modified. Implied warranties may also be affected.

**SPECIFICATIONS SUBJECT TO CHANGE:** The information contained in this manual is believed to be correct at the time of printing. However, Yamaha reserves the right to change or modify any of the specifications without notice or obligation to update existing units.

**ENVIRONMENTAL ISSUES:** Yamaha strives to produce products that are both user safe and environmentally friendly. We sincerely believe that our products and the production methods used to produce them, meet these goals. In keeping with both the letter and the spirit of the law, we want you to be aware of the following:

**Battery Notice:** This product **MAY** contain a small non-rechargeable battery which (if applicable) is soldered in place. The average life span of this type of battery is approximately five years. When replacement becomes necessary, contact a qualified service representative to perform the replacement.

**Warning:** Do not attempt to recharge, disassemble, or incinerate this type of battery. Keep all batteries away from children. Dispose of used batteries promptly and as regulated by applicable laws. **Note:** In some areas, the servicer is required by law to return the defective parts. However, you do have the option of having the servicer dispose of these parts for you.

**Disposal Notice:** Should this product become damaged beyond repair, or for some reason its useful life is considered to be at an end, please observe all local, state, and federal regulations that relate to the disposal of products that contain lead, batteries, plastics, etc.

**NOTICE:** Service charges incurred due to lack of knowledge relating to how a function or effect works (when the unit is operating as designed), are not covered by the manufacturer's warranty, and are therefore the owners responsibility. Please study this manual carefully and consult your dealer before requesting service.

**NAME PLATE LOCATION:** The graphic below indicates the location of the name plate. The model number, serial number, power requirements, etc., are located on this plate. You should record the model number, serial number, and the date of purchase in the spaces provided below and retain this manual as a permanent record of your purchase.

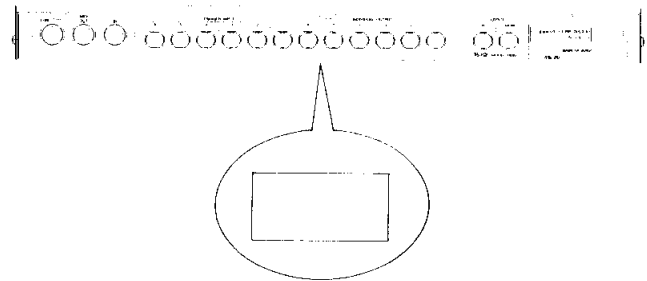

Model \_\_\_\_\_  
 Serial No. \_\_\_\_\_  
 Purchase Date \_\_\_\_\_

# IMPORTANT SAFETY AND INSTALLATION INSTRUCTIONS

---

INFORMATION RELATING TO POSSIBLE PERSONAL INJURY, ELECTRIC SHOCK, AND FIRE HAZARD POSSIBILITIES HAS BEEN INCLUDED IN THIS LIST.

**WARNING** — When using any electrical or electronic product, basic precautions should always be followed. These precautions include, but are not limited to, the following:

1. Read all Safety Instructions, Installation Instructions, Special Message Section items, and any Assembly Instructions found in this manual **BEFORE** making any connections, including connection to the main supply.
2. Main Power Supply Verification: Yamaha products are manufactured specifically for the supply voltage in the area where they are to be sold. If you should move, or if any doubt exists about the supply voltage in your area, please contact your dealer for supply voltage verification and (if applicable) instructions. The required supply voltage is printed on the name plate. For name plate location, please refer to the graphic found in the Special Message Section of this manual.
3. This product may be equipped with a polarized plug (one blade wider than the other). If you are unable to insert the plug into the outlet, turn the plug over and try again. If the problem persists, contact an electrician to have the obsolete outlet replaced. Do **NOT** defeat the safety purpose of the plug.
4. Some electronic products utilize external power supplies or adapters. **DO NOT** connect this type of product to any power supply or adapter other than one described in the owners manual, on the name plate, or specifically recommended by Yamaha.
5. **WARNING:** Do not place this product or any other objects on the power cord or place it in a position where anyone could walk on, trip over, or roll anything over power or connecting cords of any kind. The use of an extension cord is not recommended! If you must use an extension cord, the minimum wire size for a 25' cord (or less) is 18 AWG. **NOTE:** The smaller the AWG number, the larger the current handling capacity. For longer extension cords, consult a local electrician.
6. Ventilation: Electronic products, unless specifically designed for enclosed installations, should be placed in locations that do not interfere with proper ventilation. If instructions for enclosed installations are not provided, it must be assumed that unobstructed ventilation is required.
7. Temperature considerations: Electronic products should be installed in locations that do not significantly contribute to their operating temperature. Placement of this product close to heat sources such as; radiators, heat registers and other devices that produce heat should be avoided.
8. This product was **NOT** designed for use in wet/damp locations and should not be used near water or exposed to rain. Examples of wet/damp locations are; near a swimming pool, spa, tub, sink, or wet basement.
9. This product should be used only with the components supplied or; a cart, rack, or stand that is recommended by the manufacturer. If a cart, rack, or stand is used, please observe all safety markings and instructions that accompany the accessory product.
10. The power supply cord (plug) should be disconnected from the outlet when electronic products are to be left unused for extended periods of time. Cords should also be disconnected when there is a high probability of lightening and/or electrical storm activity.
11. Care should be taken that objects do not fall and liquids are not spilled into the enclosure through any openings that may exist.
12. Electrical/electronic products should be serviced by a qualified service person when:
  - a. The power supply cord has been damaged; or
  - b. Objects have fallen, been inserted, or liquids have been spilled into the enclosure through openings; or
  - c. The product has been exposed to rain; or
  - d. The product does not operate, exhibits a marked change in performance; or
  - e. The product has been dropped, or the enclosure of the product has been damaged.
13. Do not attempt to service this product beyond that described in the user-maintenance instructions. All other servicing should be referred to qualified service personnel.
14. This product, either alone or in combination with an amplifier and headphones or speaker/s, may be capable of producing sound levels that could cause permanent hearing loss. **DO NOT** operate for a long period of time at a high volume level or at a level that is uncomfortable. If you experience any hearing loss or ringing in the ears, you should consult an audiologist. **IMPORTANT:** The louder the sound, the shorter the time period before damage occurs.
15. Some Yamaha products may have benches and/or accessory mounting fixtures that are either supplied as a part of the product or as optional accessories. Some of these items are designed to be dealer assembled or installed. Please make sure that benches are stable and any optional fixtures (where applicable) are well secured **BEFORE** using Benches supplied by Yamaha are designed for seating only No other uses are recommended.

---

PLEASE KEEP THIS MANUAL

# CONTENTS

## TUTORIAL SECTION

---

<b>CONTROLS AND CONNECTORS</b> .....	2	<b>EDITING VOICES</b> .....	27
Front Panel .....	2	RM50 Voice Types.....	27
Rear Panel.....	4	Entering Voice Edit Mode .....	27
<b>SETTING UP YOUR SYSTEM</b> .....	5	Basic Voice Structure.....	28
Audio Connections.....	5	Easy Edit Parameters.....	29
MIDI Connections.....	6	Element Structure .....	30
Audio Trigger Connections .....	7	Selecting an Element to Edit .....	31
Powering Up the System.....	8	Element Parameters .....	32
Playing the Demo Songs .....	8	Other Parameters.....	33
<b>PLAYING THE RM50</b> .....	10	Editing Functions .....	33
What Is a Rhythm Kit?.....	10	Exiting Voice Edit Mode .....	34
What Is a Pitched Voice?.....	10	<b>USING THE WAVE RAM OPTION</b> .....	35
Selecting a MIDI Channel.....	11	What Is Wave RAM? .....	35
Changing the Channel Mode .....	11	Copying Waveforms From a Card.....	35
Selecting a Rhythm Kit.....	12	Using Sample Dumps.....	36
Playing a Pitched Voice.....	12	Other Wave RAM Utilities .....	36
Using Multiple MIDI Channels.....	12	Exiting the Wave RAM Utility Group .....	37
<b>EDITING RHYTHM KITS</b> .....	14	<b>USING AUDIO TRIGGERS</b> .....	38
RM50 Rhythm Kit Structure .....	14	Assigning Notes to Triggers .....	38
Entering Setup Edit Mode.....	15	Adjusting the Gain .....	39
Selecting a Note.....	15	Reducing Interference.....	41
Assigning Voices .....	17	MIDI Data Settings .....	42
Attenuating Voices .....	17	Exiting the System Utility Group .....	42
Using the Display Chase Function.....	17	<b>USING MACROS</b> .....	43
Key Off Messages.....	18	Playing a Macro.....	43
Pitch Bend Messages .....	19	Recording a Macro.....	44
Other Control Change Messages.....	19	Other Macro Functions.....	45
Naming Your Rhythm Kit.....	20		
Additional Editing Functions.....	21		
Exiting Setup Edit Mode.....	22		
<b>EDITING PITCHED VOICES</b> .....	23		
RM50 Pitched Voice Structure .....	23		
Entering Setup Edit Mode.....	24		
Selecting a Voice .....	24		
Channel Settings .....	25		
Editing Functions .....	25		
Exiting Setup Edit Mode.....	26		

## REFERENCE SECTION

---

<b>PLAY MODE</b> .....	<b>49</b>	<b>UTILITY MODE</b> .....	<b>87</b>
Functions in Play Mode.....	50	Functions in Utility Mode .....	89
Play Mode .....	51	System Utility Group.....	92
Display Chase .....	51	1. Trigger Input 1 .....	92
Input Monitor.....	52	2. Trigger Input 2 .....	93
Key Macro Playback.....	52	3. Trigger Input 3 .....	93
Key Macro Record.....	53	4. Click 1.....	95
Key Macro View.....	54	5. Click 2.....	95
Key Macro Name.....	54	6. SOUND Key Velocity .....	96
<b>SETUP EDIT MODE</b> .....	<b>57</b>	MIDI Utility Group.....	97
Functions in Setup Edit Mode .....	58	1. Program Change Mode .....	97
1. Voice Assign .....	59	2. Program Change Table.....	98
2. Voice Attenuation .....	60	3. Control Change.....	98
3. Key Off .....	61	4. Control Change Assign.....	99
4. Pitch Bend.....	61	5. Remote Switch .....	99
5. Control Change.....	62	6. Device Number.....	100
6. Trigger Note Assign .....	63	7. Bulk Transmit.....	100
7. Rhythm Kit Name .....	63	Data Card Utility Group.....	102
8. Setup Initialize .....	64	1. Save to Card .....	102
9. Setup Recall.....	65	2. Load from Card .....	103
10. Rhythm Kit Copy .....	65	3. Format Card .....	103
<b>VOICE EDIT MODE</b> .....	<b>67</b>	Wave RAM Utility Group.....	105
Functions in Voice Edit Mode .....	69	1. Waveform Name .....	105
Element Select.....	71	2. Card Waveform Copy.....	106
Element On/Off .....	71	3. Waveform Delete .....	106
1. Easy Edit 1 .....	72	4. Wave RAM Memory.....	107
2. Easy Edit 2.....	72	5. Wave RAM Initialize.....	107
3. Waveform Select .....	73	6. Sample Dump Mode .....	108
4. Element Level, Pan, and Pitch.....	74	Demo Play Utility .....	109
5. Element EG .....	75	1. Demo Play.....	109
6. Element Filter.....	76		
7. Element LFO.....	77		
8. Element Sensitivity.....	78		
9. Element Pitch EG.....	79		
10. Element Delay.....	79		
11. Element Velocity Curve.....	81		
12. Voice Output .....	82		
13. Voice Name .....	83		
14. Voice Initialize .....	83		
15. Voice Recall.....	84		
16. Voice Copy.....	85		

## APPENDICES

---

RM50 Preset Rhythm Kits.....	113	Error Messages.....	121
RM50 Preset Voices.....	114	Specifications.....	124
RM50 Waveforms.....	118	MIDI Data Format.....	125
Resetting the RM50.....	119	Index .....	133
Installation of the SYEMB06 Expansion			
Memory Board .....	120		

## **Congratulations!**

On your purchase of the YAMAHA RM50 Rhythm Sound Module. You are now the owner of one of the best-sounding, most versatile rhythm sound modules ever created for the professional musician.

## **Features**

The main attribute of the RM50 is stunning sound quality. Thanks to its combination of Yamaha's exclusive 16-bit AWM2 tone generation technology with a 22-bit D/A converter, the RM50 provides accurate audio reproduction of some of the highest-caliber sampled waveforms available.

To this foundation of high sound quality, the RM50 adds programmable digital filters and wave layering capability, plus an unprecedentedly broad range of editable voice parameters. The RM50 thus gives you total control over even the most subtle nuances of the sounds it produces. You can refine its voices as needed, or even create completely new voices to fit your specific musical requirements.

Another advantage of the RM50 is its huge capacity for sound variety. Its internal memory holds 500 preset voices, 500 partially-editable variations, and 128 user voices, as well as 64 preset and 64 user rhythm kits that help you put all of these sounds to work.

This tremendous internal sound capacity is augmented by full expandability. Three wave card slots let you use the large selection of waveforms and voices available on the optional wave cards released for the RY30, SY77 voice, and SY55. A fourth slot accepts a data card that will store an additional 500 variations, 128 user voices, and 64 rhythm kits. And an internal memory board slot allows you to add an optional 0.5 Mbyte expansion memory board that you can use as a sample RAM area. With this memory, you can copy waveforms or dump samples into the RM50 and use them to create your own original rhythm voices.

The RM50 also features a click function that you can use as a handy practice metronome, plus a built-in audio-to-MIDI converter and six audio trigger inputs that let you control the RM50 with analog controllers such as drum pads, pick-ups, or audio tape recorders. These features make the RM50 as useful to the acoustic drummer as it is to the MIDI system programmer.

## **About this manual**

This operation manual is divided into two main sections. The first, a Tutorial Section, is intended to acquaint you with the main features and operation procedures of the RM50. It is followed by a Reference Section that describes each of the RM50's many functions in full detail. Lists of internal voice names, waveform names, and other tabular information are provided in an Appendix following these two sections.

We recommend that you begin by reading through the Tutorial Section, and try performing the procedures it describes with your RM50. Once you've mastered the contents of this section, you should be familiar enough with the RM50 to start making music with it.

Once you have begun using the RM50, you may still want to check the manual now and then for details on a particular function or parameter. The Reference Section is designed to give you fast access to the information you need. It is divided into four chapters, each describing the functions available in one of the RM50's operation modes. Since each chapter has its own table of contents, you should be able to locate any given function quickly and easily. (Functions and other references can also be located using the index at the back of the manual.)



# Precautions

---

Your RM50 is a fine digital musical instrument containing delicate circuitry. To ensure a long lifetime of reliable service, observe these precautions when installing, moving, handling, and using the RM50.

- Power supply** Be sure to power the RM50 using AC power of the specified voltage. Other voltages can damage the unit.
- Electrical interference** The RM50 contains digital circuitry that may produce noise or interference and noise if placed too close to television sets, radios, or similar equipment. If such a problem occurs, move the RM50 away from the affected equipment.
- Location** Keep the RM50 away from locations where it is likely to be exposed to high temperatures or humidity, such as near radiators, stoves, etc. Also avoid locations which are subject to excessive dust or vibration which could cause mechanical damage.
- Handling** Strong physical shocks can damage the RM50; handle it with care.
- Cleaning** Never use solvents such as benzine or thinner to clean the RM50. Wipe it clean with a soft, dry cloth.
- Repairs** Aside from the optional SYEMB06 Expansion Memory Board, whose installation is explained briefly on page 120, the RM50 contains no user-serviceable parts. Do not open the case or attempt repairs or modifications yourself. Refer all maintenance to qualified Yamaha service personnel. Opening the case or tampering with the internal circuitry will void the warranty.
- Connections** Always turn the power off before connecting or disconnecting audio or MIDI cables. Grip the connector, not the cord, when plugging or unplugging cables.
- MIDI cables  
Be sure to use high-quality cables made especially for MIDI data transmission. Also avoid cables longer than about 15 meters, as long cables may pick up electrical noise that can cause data errors.
- Backup battery** The RM50 contains a lithium backup battery that maintains the contents of the internal memory even when the power is turned off. This battery should have a lifetime of about five years (or less, depending on the date of purchase).
- When the battery fails, the contents of the RM50's memory will be lost. Have the battery replaced by qualified Yamaha service personnel. Do not attempt to replace the backup battery yourself!
- Data backup** We recommend that you use the bulk transmit function to send important data to a MIDI data recorder (such as the Yamaha MDF2 Data Filer) or other storage device for safe long-term storage. Yamaha cannot be held responsible for data loss caused by battery failure or improper operation of the RM50!
- Third-party software** Yamaha cannot accept responsibility for software produced for the RM50 by third-party manufacturers. Please direct any questions or comments about such software to the manufacturer or their agents.

# TUTORIAL SECTION

# Controls and Connectors

## ■ Front Panel

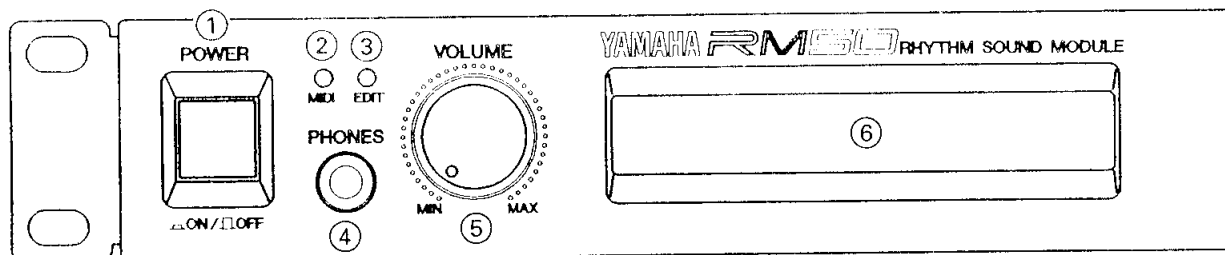

- ① **POWER switch**
- ② **MIDI lamp**  
Lights when the RM50 receives MIDI data (other than system realtime messages) at the MIDI IN terminal.
- ③ **EDIT lamp**  
Lights when the RM50 is in an edit mode.
- ④ **PHONES jack**  
Accepts a standard pair of stereo headphones (1/4" stereo phone plug) to allow headphone monitoring of the RM50's sound.
- ⑤ **VOLUME control**  
Adjusts the volume of the sound delivered from the OUTPUT (L/MONO and R) jacks on the rear panel and the PHONES jack described above.
- ⑥ **Liquid crystal display panel (LCD)**  
This two-line, 48-character backlit liquid crystal display panel shows the titles, parameters, and prompts you need to operate the RM50. Each screenful of information is known as a display **page**. The various display pages in each mode are accessed using the [PAGE-] and [PAGE+] keys described below.
- ⑦ **[PLAY] key**  
Switches the RM50 to Play mode. This mode allows you to assign different rhythm kits or pitched voices to each MIDI channel (page 51). The [PLAY] key is also used with the [SHIFT] key to switch to an Input Monitor display that lets you monitor MIDI and audio trigger input to the RM50 (page 52).
- ⑧ **[EDIT] key**  
Selects the RM50 edit modes. When the RM50 is in Play mode, this key shifts it into Setup Edit mode (page 57), letting you change rhythm kit and pitched voice parameters. From the first page of this mode, the [EDIT] key selects the Voice Edit mode (page 67), which lets you edit the parameters of individual voices. You can also use this key in combination with the [SHIFT] key to switch between two voices assigned to a rhythm kit note in Setup Edit mode, or between the two elements of a voice you are editing in Voice Edit mode.
- ⑨ **[UTILITY] key**  
Selects the RM50 Utility mode (page 87). This mode provides you with access to all system, MIDI, data card, and wave RAM utility functions, as well as to the Demo Utility function. The [UTILITY] key is also used with the [SHIFT] key to activate the Display Chase function (page 51).
- ⑩ **[MACRO] key**  
Executes key macro sequences, which speed your access to functions and parameters that you use frequently (page 52). Also, you can record, view, and name macros by pressing the [MACRO] key while holding the [SHIFT] key.
- ⑪ **[PAGE-] and [PAGE+] keys**  
Select the various display pages available in the Setup Edit, Voice Edit, and Utility modes. They are also used with the [SHIFT] key to switch on or off the elements of a voice being edited.

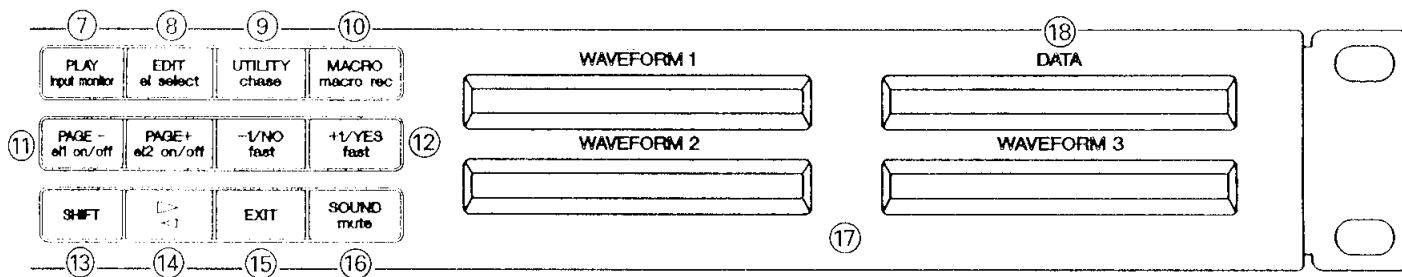

**12 [+1/YES] and [-1/NO] keys**

Raise and lower numerical parameter values, or select from among the various settings available in each of the RM50's operation modes. Either key can be pressed briefly and then released to change a setting by a single step, or held down for continuous scrolling. In many cases, you can use these keys with the [SHIFT] key to scroll at high speed. You can also use the [+1/YES] key in combination with the [SHIFT] key to execute functions, such as the Copy, Recall, and Initialize operations available in the edit modes, whose names are followed by a question mark in the LCD display.

**13 [SHIFT] key**

Used in combination with other keys to access the additional functions assigned to those keys. These additional functions are indicated by the lower-case function name printed below the names of the keys. To select these functions, you must press the desired key while holding down the [SHIFT] key.

**14 [▷] key**

Moves the screen pointer from parameter to parameter in many of the RM50's display pages. To move the pointer in the reverse direction, use this key together with the [SHIFT] key.

**15 [EXIT] key**

Allows you to abort operations that may irrevocably change data, and to exit from functions and operation modes.

**16 [SOUND] key**

Plays the currently selected sound so you can hear what it sounds like. This key can also be used with the [SHIFT] key to mute continuous sounds that will play on endlessly in the absence of a MIDI note off message.

**17 WAVEFORM slots 1-3**

These data card slots accept the wave cards released for the RY30, SY77, and SY55. The RM50 can select and play these waveforms in place of its own preset waveforms. Wave cards released for the RY30 also contain editable voices which the RM50 loads automatically. The RM50 creates voice data for cards released for the other instruments. Finally, the RM50 can play the demo songs on data cards released for the RY30.

**18 DATA slot**

This data card slot accepts a data card that will store additional voices, voice variations, and rhythm kits, effectively doubling your RM50's user memory capacity.

## ■ Rear Panel

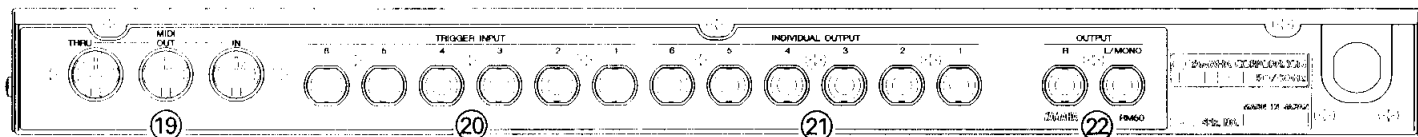

### ①⑨ MIDI terminals

The MIDI IN terminal receives MIDI messages from a sequencer or other MIDI keyboard controlling the RM50. The MIDI THRU terminal passes this data on unchanged for use by another MIDI device connected in series to the RM50. The MIDI OUT terminal transmits note messages generated in response to signals received by the TRIGGER INPUT jacks, as well as bulk data describing the RM50's internal settings when the MIDI bulk transmission function (page 100) is executed.

### ①⑩ TRIGGER INPUT jacks

These six jacks accept signals from analog controllers such as drum pads, drum pickups, and audio tape recorders, which are then fed into the RM50 tone generator by a built-in audio/MIDI converter. The parameters controlling the input from these jacks are set using the audio trigger utility functions (pages 92 through 94). Actual control of the RM50 by audio input is enabled by the Display Chase function (page 51).

### ①⑪ INDIVIDUAL OUTPUT jacks

Each RM50 instrument can be assigned to one of the six individual output jacks instead of the stereo OUTPUT jacks described below. The volume of signals output from these jacks are not affected by the VOLUME control.

### ①⑫ OUTPUT jacks

These are the RM50's main stereo output jacks. The panning of voice elements assigned to stereo output are determined individually for each element. If no plug is inserted in the R jack, the left- and right-channel signals are combined and delivered as a monaural signal from the L/MONO jack.

# SETTING UP YOUR SYSTEM

The process of setting up the RM50 is mainly a matter of connecting it to the other audio equipment and MIDI devices in your system. Of course, the configuration of your system depends entirely on your individual requirements. It would be impossible to cover all the possibilities in this manual; but here are a few examples to help you get started.

## Audio Connections

If you will be connecting your RM50 to a stereo sound system only, use the OUTPUT jacks. These are the RM50's main stereo outputs: they are controlled by the VOLUME control on the front panel. If you have a monaural sound system, use only the L/MONO jack.

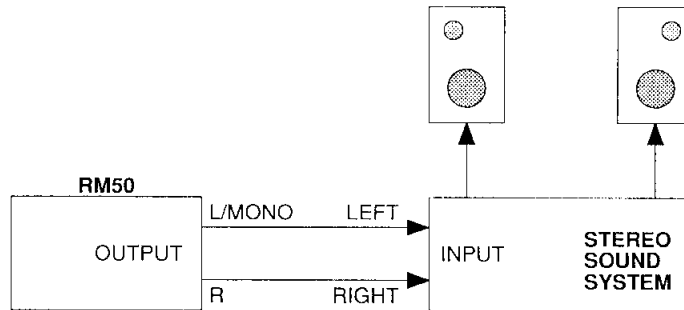

If you plan to use the RM50 with a mixing console or an integrated multi-track recorder/mixer, you might want to take advantage of the INDIVIDUAL OUTPUT jacks in addition to the OUTPUT jacks. You can thus connect a total of eight outputs to separate input channels of the mixer, and assign voice elements to different output channels in order to process them separately. Elements assigned to the OUTPUT jacks will be delivered in premixed stereo, using the specified level and panning settings. The levels and panning of elements output via the INDIVIDUAL OUTPUT jacks, on the other hand, will be determined entirely by your mixer settings.

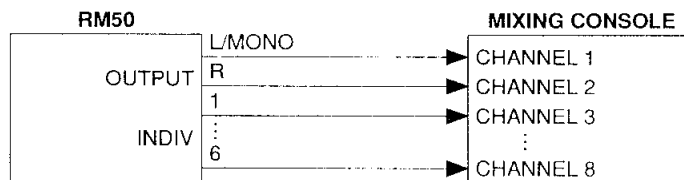

**CAUTION:** Make sure that both the RM50 and your sound system are turned OFF when making connections.

## MIDI Connections

There may be times when you will want to use a MIDI keyboard to control the RM50. This can be accomplished by connecting the MIDI OUT terminal of the keyboard to the RM50's MIDI IN terminal. You'll also have to make sure that the keyboard's transmit channel setting matches the RM50 receive channel corresponding to the voice or rhythm kit you want to play.

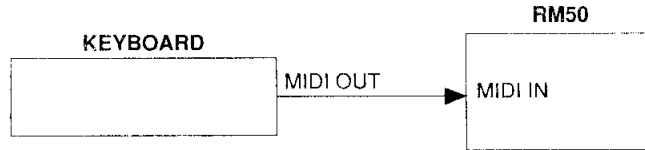

More complex MIDI systems may require that the RM50 be interfaced to a sequencer (or personal computer) as well as a master keyboard. If your sequencer has multiple MIDI OUTs, the RM50 can simply be connected to one while your other tone generating devices are connected to the others.

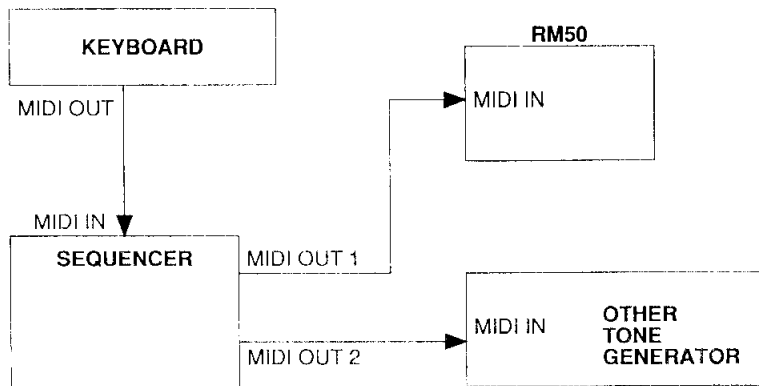

If your sequencer only has a single MIDI OUT, however, the RM50 and other tone generators will have to be connected in series. The first instrument in the chain will of course be connected to the sequencer's MIDI OUT. All subsequent devices will be connected to the previous device's MIDI THRU terminal.

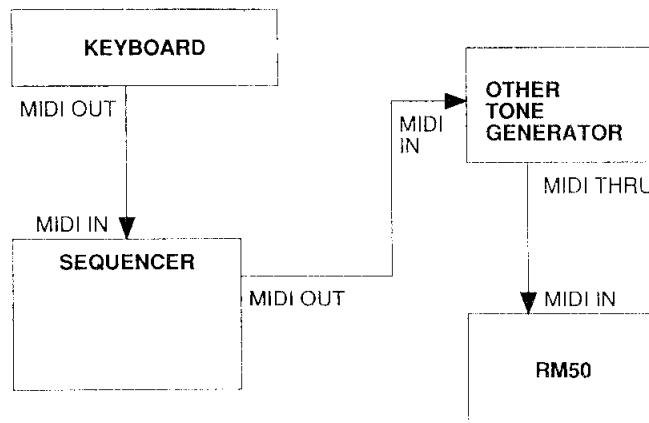

If there will be more than about three or four devices in the chain, however, it is a good idea to use a MIDI parallel box to minimize the possibility of delayed notes.

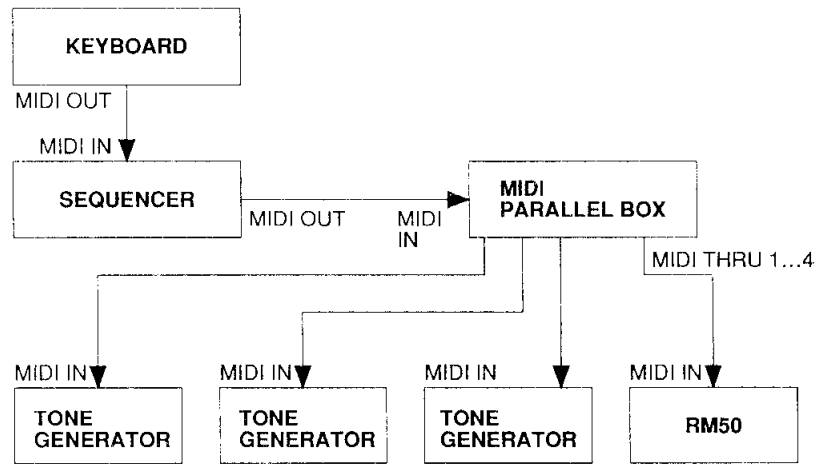

You may want to use the RM50's Bulk Transmit function to store its data in your sequencer, a MIDI data filer such as Yamaha's MDF2, or another device with MIDI data recorder (MDR) capability. To do so, you will need to connect the MIDI OUT terminal of each device to the MIDI IN terminal of the other.

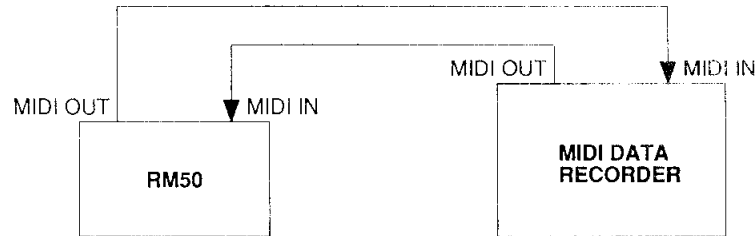

### Audio Trigger Connections

To control the RM50 using triggers such as acoustic drum pickups or non-MIDI electric drum pads, connect each pickup or pad directly to one of the RM50's TRIGGER INPUT jacks. There is no need to connect a trigger control unit between the triggers and the RM50, since the RM50 possesses its own built-in A/D converter which converts the trigger signals to MIDI note information which the RM50 can play or pass on to other tone generators.

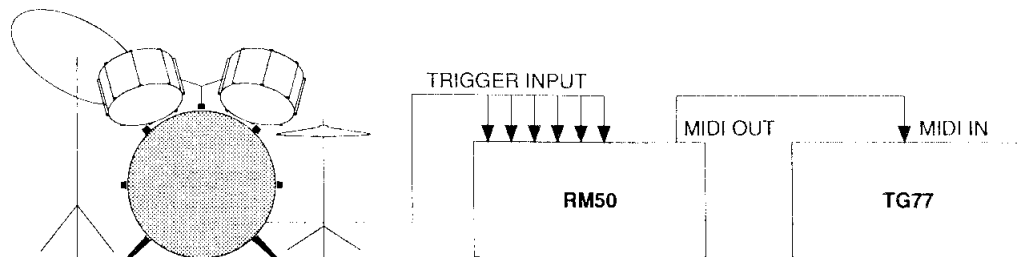

The audio trigger function is also useful for remixing. To control the RM50 with signals from a multitrack tape recorder, connect each TRIGGER INPUT jack to the output jack for a different track. You can connect the RM50 to the recorder either directly or by way of a mixing console.



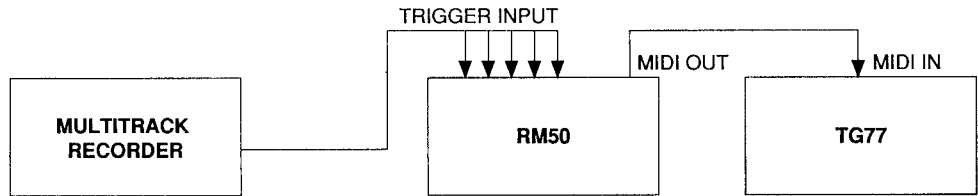

## Powering Up the System

Believe it or not, there's a right way and a wrong way to turn on the components in any music system.

In general, instruments and preamps or mixers should always be turned on before subsequent power amplifiers. Also, the master volume controls on preamps or mixers should be turned all the way down while the system is being powered up. Failure to follow these rules can result in damage to your power amplifiers and speakers.

Also, MIDI transmitting devices should be turned on before their associated receiving devices. We recommend that you use the following procedure when powering up your system:

1. Make sure your sound system's volume controls are turned all the way down before you turn the power on.
2. Turn on the master keyboard (if any).
3. Turn on the sequencer (if any).
4. Turn on the RM50.
5. Turn on the sound system.
6. Raise the sound system's volume to a reasonable level.

## Playing the Demo Songs

The RM50 is programmed with two demonstration songs that you might want to listen to after setting up your system. Before you continue reading the manual, take a short break and enjoy the sound of your RM50!

1. Press the [UTILITY] key to enter Utility mode, then press the [PAGE+] key a few times until the display below appears.

```

UTL/Demo
Press "+1/YES" to enter
  
```

2. Press the [+1/YES] key.

```

UTL/Demo
stop Pre<Song1:SKINBIT
  
```

3. If the blinking pointer is not pointing to the word "stop" in the second line of the LCD, press the [▷] key once or twice to move it there.
4. Press the [+1/YES] key to start the demo playing. The demo songs will play in sequence repeatedly until you press the [-1/NO] key.

```
UTL/Demo  
Play<Pre Song1:SKINBIT
```

5. Press the [-1/NO] key when you're done listening to the demo songs, then press [PLAY] to return to Play mode.

If at some later time you want to listen to a particular demo song, or to the demos that come on a wave card, you can do so using the Demo utility function described briefly above. Detailed instructions for this function are given on page 109.

# Playing the RM50

---

The RM50 contains a great deal of sound variety: 500 preset voices, 500 partially-editable preset voice variations, and 128 user voices, as well as 64 preset and 64 user rhythm kits. The first thing you'll want to know to put all this variety to work is how you can get at the sounds.

Before we can explain the procedures used to select and play the RM50's sounds, however, you will need to understand the difference between the two methods the RM50 uses to assign voices to a MIDI channel. The two methods, or channel modes, are referred to using descriptive names: "rhythm kit" and "pitched voice".

## What Is a Rhythm Kit?

You will normally play the RM50's voices by selecting groups of different sounds known as **rhythm kits**. The rhythm kit collects rhythm-related voices in the manner of many recent synthesizers: different voices are assigned to each MIDI note number, allowing you to play a broad range of rhythm sounds within a single keyboard range.

In addition to voice assignments, a rhythm kit lets you specify, for each note, the volume at which it plays the assigned voice, whether it will accept or ignore key off messages, how it will respond to pitch bend messages, and which other control change messages it will acknowledge. This entire assembly of voice assignments and settings can be given a name and stored in an internal rhythm kit memory bank (or in a card memory bank, if you insert a data card in the DATA slot).

The rhythm kit is thus equivalent in many ways to the "drum voices" of the SY77, the SY99, and related tone generators. (We have used term "rhythm kit" for the RM50 to underscore the fact that this rhythm sound module does more than just drums!) One advantage of the RM50's rhythm kits is the fact that notes B0 through A#1 have two voice **slots** which allow you to assign two voices, rather than just one, to each of the note numbers in this range.

## What Is a Pitched Voice?

In addition to rhythm kits, the RM50 gives you another way to select and play its voices. You can assign a single voice to play all notes, through the entire range from C-2 to C8, received on a specified channel. Voices selected for playing in this manner are known as **pitched voices**. The pitched voice setup, which corresponds roughly to the normal voices of most synthesizers, is handy for playing bass voices, orchestra hits, and other melodic sound effects.

A pitched voice consists of a voice selection plus a **handful** of other parameters, corresponding to those made for the individual notes of a rhythm kit, which specify how the RM50 will respond to key off, pitch bend, and control change messages received on the channel in question. Unlike the rhythm kit settings, however, the channel settings are not permanently saved in memory banks, since a pitched voice requires only one setting of each type.

The important point to understand here is that the word "voice" indicates two different things at different levels. At the most basic level, a **voice** is a discrete sound unit produced by one or two waveform elements. Voices can be assigned to either a single note number (as part of a rhythm kit), or across a channel's entire note number range. A **pitched voice** is what you get when you use a voice in the latter manner.

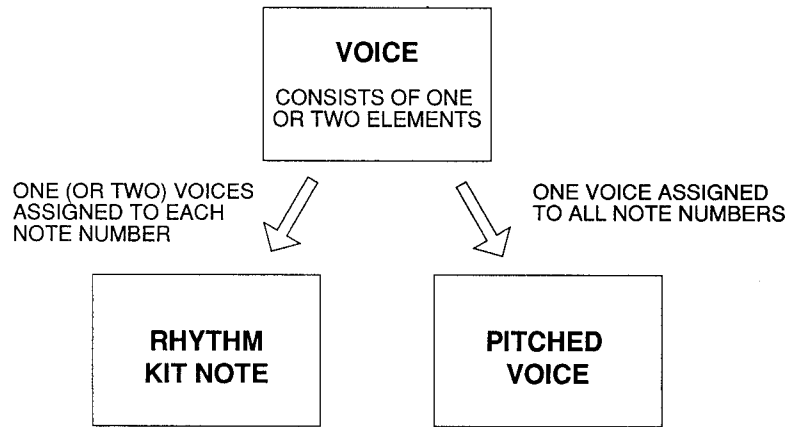

You will find the RM50's functions much easier to use if you keep this distinction in mind.

### Selecting a MIDI Channel

The RM50 can play a different rhythm kit or pitched voice in response to note information received on each of the sixteen MIDI channels. When selecting a rhythm kit or pitched voice to play, therefore, you will have to first determine which channel the keyboard or sequencer will be transmitting on.

Say, for example, you will be transmitting notes for a drum set part on channel 10. You want the RM50 to respond to these notes with drum kit I-5, "Studio 2". Before you can select this rhythm kit, you will have to select the Play mode display for channel 10.

Begin by pressing the Play key to return the RM50 to Play mode, if you have not done so already.

```
C01<Mode=rhythm kit
Kit :P- 1 Rock 1
```

The "C01" in the upper corner of this display page tells you that the current rhythm kit selection for channel 1 is being displayed. Use the [▷] key to move the pointer to this number (if it is not there already), then press the [+1/YES] key nine times to select channel 10.

```
C10<Mode= off
```

### Changing the Channel Mode

As you can see, the RM50 **channel mode** selected for channel 10 is set to "off". This means that the RM50 will ignore any notes received on this channel. If you want it to play a drum part on this channel, you will have to change this setting to "rhythm kit".

To do so, press the [▷] key once to move the pointer to the word "off". Then press the [-1/NO] key.

```
C10/Mode=pitched voice<
Uce :P-SE 49 BA K111B
```

This changes the program mode to “pitched voice”. You would use this setting to play a bass part, for example. For the moment, however, press the [-1/NO] key once more to display the “rhythm kit” setting.

```
C10/Mode=rhythm kit  <
Kit  :P- 1 Rock 1
```

## Selecting a Rhythm Kit

After you have selected the correct channel mode, you can begin choosing a rhythm kit. First you must select the bank. The RM50 gives you three rhythm kit banks to choose from – the preset bank, the internal bank, and the data card bank – each of which holds 64 kits. These banks are represented by the letters “P”, “I”, and “C” in the display.

To change the bank selection from the preset bank to the internal bank, use the [▷] key to move the pointer to the letter “P” in the display, then press the [+1/YES] key.

```
C10/Mode=rhythm kit
Kit  :I< 1 Rock 1
```

Now all you have to do is change the rhythm kit number. Press the [▷] key again to move the pointer to the rhythm kit name in the LCD, then press the [+1/YES] key four times to select kit I-5. The name and number of the kit will appear in the LCD.

```
C10/Mode=rhythm kit
Kit  :I< 5 Studio 2
```

That’s all there is to it. The RM50 is ready to play the drums for you.

## Playing a Pitched Voice

The procedure for choosing a voice to play as a pitched voice is the same as that for selecting a rhythm kit, except that you must set “pitched voice” instead of “rhythm kit” as the channel mode. When you select this mode, the RM50 will give you 23 voice banks to choose from. This may seem like a lot of voice banks ... but it makes a lot of sense when you consider that the RM50 can hold 1,128 voices in its internal memory alone!

The number of voices in each bank varies with the bank type. A table describing the type and number of voices in each bank is presented on page 59.

## Using Multiple MIDI Channels

We mentioned earlier that the RM50 can respond to note messages received on each of the sixteen MIDI channels. To use the MIDI terminology, the RM50 is a **multitimbral tone generator** capable of playing sixteen timbres simultaneously (within the limits of its sixteen-note polyphonic voicing capacity). Because it is a rhythm sound module, it differs from other multitimbral tone generators in that its timbres normally consist of groups of different voices – rhythm kits – rather than single voices.

The RM50 is in fact capable of remembering 32 different channel setups – one rhythm kit selection and one pitched voice setup for each channel – at once. Of course, it can only use sixteen of these setups at any given time, as the channel mode of each channel must be set to either “rhythm kit” or “pitched voice”. Still, it keeps the sixteen unused setups in its memory as alternate selections.

CHANNEL	RHYTHM KIT SETUP	PITCHED VOICE SETUP	OFF
1	Kit Selection P 1 “Rock 1”	Voice Selection P-SE 49 plus channel parameters	—
2	Kit Selection P 1 “Rock 1”	Voice Selection P-SE 49 plus channel parameters	—
3-16	Kit Selection P 1 “Rock 1”	Voice Selection P-SE 49 plus channel parameters	—

(Shaded areas indicate factory preset channel modes.)

In addition to the manual methods described above, it is possible to select a different rhythm kit or voice for a channel by sending the RM50 a program change message on the channel in question. To switch the channel mode between the “rhythm kit” and “pitched voice” settings via MIDI, you can either use the Program Change Table function described on page 98, or bank select messages calling the bank numbers listed on page 97.

# Editing Rhythm Kits

The RM50 comes programmed with an assortment of 64 preset rhythm kits designed to cover a variety of musical styles and genres. (A complete listing of these rhythm kits is included in the Appendix.) These kits should meet most of your needs for rhythm sound variety. Eventually, however, you may find that you will want to create your own rhythm kits in order to rearrange voice assignments to suit your tastes, as well as to incorporate the voices you create in Voice Edit mode.

The RM50's capacity of 64 internal user rhythm kits gives you plenty of room to set up your own new kits. These user kits are initially programmed with copies of the preset kits. To create a new kit, you may find it easiest to choose an arrangement similar to the one you are planning, then edit it as needed to bring it closer to your ideal. This tutorial describes briefly the method for accomplishing this.

## RM50 Rhythm Kit Structure

Each RM50 rhythm kit consists of a series of voice assignments – one or two voices to each note number – plus associated settings which determine how these voices perform as part of the kit.

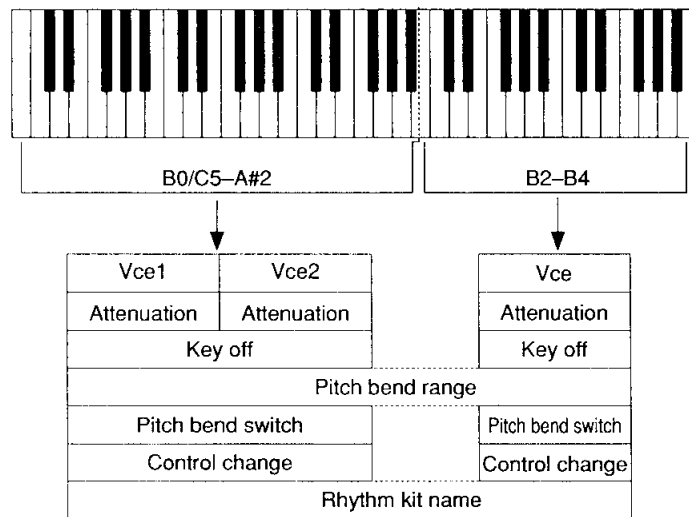

As the illustration above shows, notes B0 through A#2 have two voice slots (Vce1 and Vce2), each of which can be assigned a different voice. (“B0/C5” is displayed when B0 is selected because the RM50 treats these two as the same note.) This arrangement allows the RM50 to play two voices, simultaneously, in response to a single MIDI key on message. The remaining notes, B2 through B4, have only one slot (Vce).

Each voice is accompanied by an attenuation parameter which adjusts its volume level. This allows you to balance the voices in the kit with respect to each other. Both voice slots for the notes between B0/C5 and A#2 have their own attenuation values, so you can adjust the level of layered voices played by these notes independently.

Every note has a several other parameters which specify how it will respond to MIDI key off, pitch bend, and control change messages. Each note has only one setting for of each of these parameters, regardless of the number of voice slots available. When two layered voices are played by one of the notes between B0/C5 and A#2, therefore, both will react in the same manner to these MIDI messages.

There is one setting which affects all of the notes in the kit rather than individual notes: the pitch bend range parameter. It is possible to turn the pitch bend function on or off for each note using the pitch bend switch parameter. However, all notes that are switched to "on" will be bent by the same amount in response to pitch bend messages, since the pitch bend range setting operates at the channel level.

## Entering Setup Edit Mode

To get an idea how you can go about modifying these settings, let's try editing rhythm kit I-5, "Studio 2", which we selected in the preceding tutorial. Check to make sure the name of this kit is still displayed.

```
C10/Mode=rhythm kit  <
Kit  :I- 5 Studio 2
```

Now press the [EDIT] key. The red EDIT lamp to the left of the VOLUME control will light up, and a display like the following will appear in the LCD. (If the word "KIT" in the upper left corner of the display is followed by a parameter name, press the [PAGE-] key and hold it until the display stops changing.)

```
KIT      Note=B 0/C 5
Vcel1 :P-BD  42 RM Lizr<
```

## Selecting a Note

This is the display for the Note Assign function, which lets you assign voices to notes. You must begin by selecting the note you wish to change. Let's try changing C1, one of the notes in the range with two voice slots.

First, use the [▷] key to move the blinking pointer to the note number in the upper right corner of the LCD, if it is not there already. Then, press the [+1/YES] key to change the note number in the upper right corner to "C1 (36)". (If a higher note number is displayed, you will have to press the [-1/NO] key rather than the [+1/YES] key to lower it.)

```
KIT      Note=C 1( 36)<
Vcel1 :P-BD   5 DR Danc2
```

## Assigning Voices

Next, press the [▷] key to move the pointer to the name of the currently selected voice slot. This should be set to Vcel1; if it isn't, press the [-1/NO] key.

```
KIT      Note=C 1( 36)
Vcel1<:P-BD   5 DR Danc2
```

The lower line of this display tells us that preset bass drum voice P-BD 5, "DR Danc2", has been assigned to voice slot 1 of note C1. (The letters DR beginning the name of this voice indicate that it is a "dry" voice – that is, it lacks reverb.)



Let's change the voice selection to a snare drum. Press the [▷] key again to move the pointer to the bank name, and press the [+1/YES] key once to select the preset snare drum bank, P-SD. (As soon as you make this change, the letter "K" beginning the word "KIT" in the upper left corner of the display will change to a small letter, indicating that the voice has been edited. We will explain the reason for this in our description of the Setup Recall function at the end of this tutorial.)

```
KIT      Note=C 1( 36)
Vce1 :P-BD<  5 DR Custr
```

Next, press the [▷] key one last time to move the pointer to the voice selection. Press the [+1/YES] key ten times to select voice 15, "DR Tite2".

```
kIT      Note=C 1( 36)
Vce1 :P-SD  15 DR Tite2<
```

That takes care of one voice slot. Now for the other: press the [▷] key twice while holding down the [SHIFT] key to move the pointer back to the voice slot name. (You can use the shifted [▷] key when moving the pointer backwards will get it where you want it faster in displays containing a large number of parameters.) Then press the [+1/YES] key to change the slot to Vce2.

```
kIT      Note=C 1( 36)
Vce2<:OFF  -----
```

As you can see, this slot has been turned off. Try changing it to a high tom sound using the method described above. You will have to use the [-1/NO] key to change the bank setting to P-TM, and the [+1/YES] key to select the new voice. Let's go with voice 21, "DR Jaz1". (You might want to try pressing and holding the [+1/YES] and [-1/NO] keys to scroll through the bank and voice options rapidly.)

```
kIT      Note=C 1( 36)
Vce2 :P-TM  21 DR Jaz1 <
```

This completes the setting. Note C1 of the drum kit now plays a snare drum sound layered with a high tom. To see how this sounds, press the [SOUND] key. You may want to use this key while editing a rhythm kit note – or a voice, in Voice Edit Mode – in order to check how the changes you make affect the sound produced.

## Attenuating Voices

Now, press the [PAGE+] key. The Voice Assign display will be replaced by the Voice Attenuation display, indicated by the letters "ATT" following the word "KIT" in the upper left corner of the LCD. This display allows you to adjust the balance of the voices assigned to notes by lowering the level of certain voices from their standard level.

Let's say we want the layered snare drum/tom note we are creating to be mostly snare, with just a hint of tom for flavor. To accomplish this, we must lower the level of the tom voice. Try using the [+1/YES] key to raise the Vce2 attenuation setting to 5.

```
kIT/ATT Note=C 1( 36)  
Vce2 : 5<
```

Next, let's check the setting for Vce1. We could move the pointer back to the voice slot name and change it as we did before – but wait! There's an easier way. Try pressing [EDIT] while holding down the [SHIFT] key. This will switch the display between Vce1 and Vce2.

You can use the shifted [EDIT] key to make fast changes to the Voice Assign and Voice Attenuate settings for both voice slots of notes between B0/C5 and A#2. It does nothing, however, when a note outside this range is selected.

The attenuation setting for the snare drum voice will probably be set to a value of 1. Lower it to 0, to increase the snare drum volume to maximum.

```
kIT/ATT Note=C 1( 36)  
Vce1 : 0<
```

Now try pressing the [SOUND] key. The note C1 should produce the sound we described: a tight snare with a touch of tom.

## Using the Display Chase Function

The Voice Attenuate function is useful for balancing the two voices of a two-slot note against each other, as we have done here. It is mainly used, however, to balance the level of each note in the rhythm kit, so that every note will produce a predictable amount of volume when played.

To balance a rhythm set, you must check the sound of every note by playing each note with the same velocity, then lower the volume of notes which sound too loud. Since the [SOUND] key plays notes at a fixed velocity, it is useful for doing this; but then balancing a rhythm kit becomes an arduous process of moving the pointer back and forth between the note number and the attenuation parameter.

Note number

```
kIT/ATT Note=C 1( 36)  
Vce1 : 0<
```

Attenuation

Adjusting all of the notes in a rhythm kit could take some time if you use this method. To speed the task, you will want to connect your RM50 to a MIDI keyboard as shown on page 6. Make sure that the keyboard is transmitting on the RM50 channel you have selected – we have chosen channel 10 for this example – and set it so that it plays every note with a fixed velocity. Finally, turn down the volume for the keyboard’s internal tone generator so that you will hear the RM50 alone.

Next, press [UTILITY] while holding down the [SHIFT] key. A display like the following should appear:

```
Display chase : on<
```

The setting to the left of the pointer should read “on”. If it doesn’t, press the [+1/YES] key to correct it. Then press the [EXIT] key to return to the Voice Attenuation function.

Now try playing a few notes on your keyboard. Each time you press a key, you should hear the sound of the RM50 voice (or voices) assigned to the note. At the same time, the RM50 display will change to show the Voice Attenuation setting for the note you play. The Display Chase function thus lets you control the RM50’s display, as well as its sound, from an external keyboard.

You can now balance your rhythm kit quickly and easily. Leaving the pointer at the attenuation parameter, use the MIDI keyboard to select notes, and the [+1/YES] and [-1/NO] keys to change their attenuation. You will still have to switch between the two voice slots for notes between B0/C5 and A#2; but this, too, can be done without moving the pointer by pressing the [SHIFT] and [EDIT] keys.

MIDI keyboard

```
kIT/ATT Note=C 1( 36)
Vcel : 0<
```

[SHIFT] + [EDIT]      [+1/YES] and [-1/NO]

The Display Chase function can help to simplify other rhythm kit editing tasks, such as the Note Assign process explained above, or the adjustment of the other settings described in the following paragraphs. Try using it as you read through the remainder of this tutorial to check the settings for a variety of notes.

## Key Off Messages

Press the [PAGE+] key again. The next display, that for the Key Off function, allows you to specify whether the RM50 should accept or ignore key off messages for the selected note.

```
kIT/Koff Note=C 1( 36)<
Key off message: ignore
```

The “accept” setting is used to control the length of notes played by pitched voices such as bass guitars and other melodic instruments. Since we have set C1 to play two drum sounds which naturally have fixed, relatively short note lengths, you will want to leave it set to “ignore”.

## Pitch Bend Messages

If you press the [PAGE+] key a third time, you will see the Pitch Bend display shown below.

```
kIT/PB  Note=C 1( 36)<
Range:12< Sw:off
```

This function lets you set how the rhythm kit you’re editing will respond to pitch bend messages. (If desired, you can assign pitch control to a control change number instead using the Control Change Assign function described on page 98). The range parameter determines how far, in half steps, any note in the kit can be bent by such a message. A setting of 12 thus allows notes to be bent up or down one full octave.

As we mentioned above, this parameter sets the pitch bend range for the entire channel rather than for individual notes. If you change this setting for one note, therefore, it will change for all notes.

The switch parameter (indicated by the letters “Sw” in the display) specifies whether the note you’re editing will respond to pitch bend messages at all. Any notes for which this parameter is set to on will be bent by received pitch bend messages; other notes will simply ignore such messages. All notes which respond to pitch bend messages will be bent by an equal amount within the specified range.

You can create some interesting effects by bending the pitch of drum sounds, such as the snare and tom voices we’ve selected for note C1. For the time being, however, let’s stick with the more orthodox arrangement. Make sure that the switch parameter is set to “off” for this note before moving on to the next item.

## Other Control Change Messages

Another press of the [PAGE+] key will show you the last display containing MIDI-related rhythm kit parameters.

```
kIT/Uo1  Note=C 1( 36)
on<off off off off off
```

This function specifies which parameters of the voice or voices played by the note you’re editing will respond to control change messages. Since the display contains six parameters, there is no room for the RM50 to show the name of each parameter next to its setting, as it did for the Key Off and Pitch Bend functions. Instead, the parameter names are displayed in the top row next to the function name.

Try moving the pointer among the parameters in the bottom row, and checking the name of each against the following table:

DISPLAY	PARAMETER	DESCRIPTION
kIT/Vol Note=C 1( 36) on<off off off off off	Volume	Sets the voice's overall output level.
kIT/Dcy Note=C 1( 36) on off<off off off off	Decay	Adjusts the decay time of both voice elements.
kIT/Pan Note=C 1( 36) on off off<off off off	Pan	Adjusts the stereo position of both voice elements.
kIT/Fil Note=C 1( 36) on off off off<off off	Filter	Adjusts the cutoff frequencies of the filters applied to both voice elements.
kIT/Bal Note=C 1( 36) on off off off off<off	Balance	Adjusts the balance between the voice's two elements.
kIT/Mod Note=C 1( 36) on off off off off off<	Modulation	Adjusts the depth of LFO modulation being applied to the voice's elements.

These settings all affect the note in a manner similar to the pitch bend switch parameter: the note will respond to control change messages corresponding to parameters set to “on”, and ignore those corresponding to parameters which are turned off. You can assign control change numbers to these voice parameters using the Control Change Assign function described on page 98.

Feel free to change the control change message settings for note C1 before you move on to the next function.

## Naming Your Rhythm Kit

Now that you've made a few changes to rhythm kit I-5, you may want to give it a name so that it will be easy to find the next time you try to select it. The next function, displayed by two more presses of the [PAGE+] key, allows you to do just that. (We will skip the Trigger Note Assign function for the moment, as it is explained in detail on page 38.)

```
kIT/Name
      I 5[Studio 2 ]
```

The name field in the bottom row of the screen allows you to change the name of the rhythm kit. A list of the characters you can use to name the kit is given on page 55.

Let's try renaming the rhythm kit to "Test Kit". Use the [▷] key to select a letter to change, and then use the [+1/YES] and [-1/NO] keys to change it. Repeat this process for each letter, until the display appears as shown below:

```
kIT/Name  
I 5[Test Kit ]
```

While you're changing letters, you may find that it takes quite a while to scroll through all the options. You can speed this process up by holding down the [SHIFT] key when you press the [+1/YES] or [-1/NO] keys.

This high-speed scrolling technique works for nearly all of the RM50's parameters; remember, however, that you cannot use it for operations which are executed by the combination of the [SHIFT] and [+1/YES] keys, such as the Initialize, Recall, and Copy operations which are described in the following paragraphs.

## Additional Editing Functions

The remaining Setup Edit mode functions facilitate the rhythm kit editing process by allowing you to initialize, restore, or copy all of the kit's parameters at once. Each of these operations is accessed by an additional press of the [PAGE+] key, and executed by pressing [+1/YES] while holding down the [SHIFT] key.

```
kIT/Init?  
I 5 Test Kit
```

The Setup Initialize operation leaves the name of the rhythm kit unchanged, but sets all of its other parameters to their default values (which are listed on page 64). This function comes in handy when you want to create a rhythm kit from scratch rather than edit an existing kit.

```
kIT/Recall?  
I 5 Test Kit
```

The Setup Recall operation restores all the parameters of the rhythm kit to the values they had before you began editing. You will remember that as soon as you started editing kit I-5, the first letter of the word "KIT" in the upper left corner of the screen changed to a small letter, to remind you that the kit had been edited.

Unedited kit

```
KIT      Note=C 1( 36)  
Uce1 :P-BD  5 DR Danc2<
```

Edited kit

```
kIT      Note=C 1( 36)  
Uce1 :P-SD 15 DR Tite2<
```

At the same time, the RM50 stored the unedited data in a memory area known as the “recall buffer”. This original data will be retained in this buffer even if you turn the RM50’s power off. If you decide you don’t like the changes you’ve made, you can use the Recall function to restore the kit to its original state.

When you use the Recall function to recall the old data for a rhythm kit, the edited data will take its place in the recall buffer. This means you can use the recall buffer to switch back and forth between the new and old settings, to compare the sounds they produce.

Once you start editing a different rhythm kit, however, all data will be cleared from the recall buffer, and the currently recalled settings for the previous kit will become permanent. If, for example, you exit Setup Edit mode right now (without recalling the original data for kit I-5), then begin editing a new kit, the original data for kit I-5 will be cleared from the buffer, and the edited data – including the name “Test Kit” – will become permanent. If, on the other hand, you recall the original data before editing the new kit, the original data will become permanent and all the time you spent editing this kit will be wasted.

In either case, the first letter of the channel mode indicator will return to normal the next time you select rhythm kit I-5, indicating that it is no longer possible to restore the data from the recall buffer.

```
kIT/COPY?  
to <I 5 Test Kit
```

The Rhythm Kit Copy function copies rhythm kit settings from one bank and kit number to another. You will find this operation helpful when creating an edited version of an existing rhythm kit. To copy a rhythm kit, you must specify whether you want to copy data to or from the currently selected rhythm kit bank and number. Detailed instructions for using this function are given on page 65.

## Exiting Setup Edit Mode

When you’re done editing a rhythm kit and want to return to Play mode, press either the [EXIT] key or the [PLAY] key. The RM50 will return to the display we started with at the beginning of this tutorial. The next time you enter Setup Edit mode to edit a rhythm kit or pitched voice, the LCD will display the Setup Edit page you last selected in this mode.

# Editing Pitched Voices

The RM50's pitched voice channel mode gives you the option of assigning a single voice to a channel's entire note range in order to accommodate parts for bass guitars, melody percussion instruments, and melodic sound effects. You will want to use this mode particularly when you use the RM50's playing the waveforms available on sound cards released for the SY55 and SY77.

You can edit a pitched voice's parameters using the Setup Edit mode. The method for editing a pitched voice setup is thus much the same as that described for rhythm kits in the preceding tutorial. However, the structure of the pitched voice setup is different, and the selection of available parameters is somewhat more limited. These differences are described in detail below.

## RM50 Pitched Voice Structure

A pitched voice consists of a single voice selection plus a handful of settings which determine how the voice reacts to control messages received on the MIDI channel playing the voice. You can compare the illustration below with the one on page 14 to get a clear idea of how the structure of the pitched voice setup differs from that of a rhythm kit.

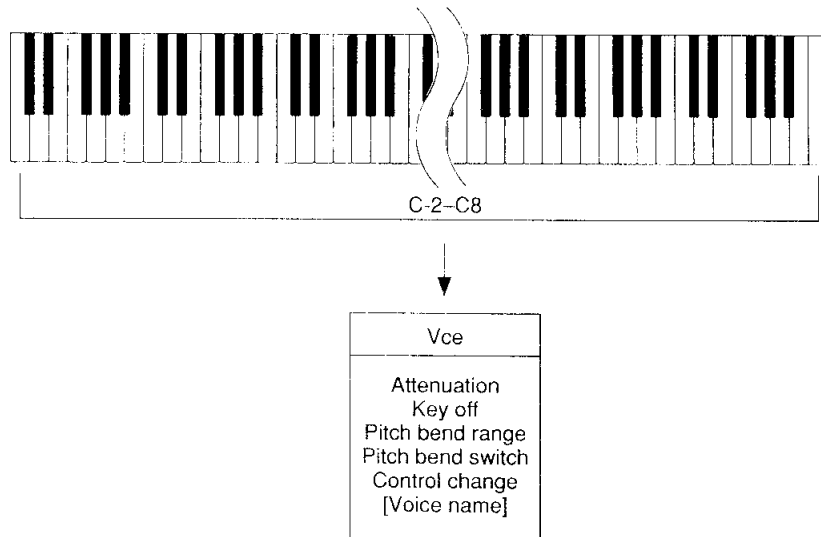

First, a pitched voice cannot be named, as rhythm kits can. When a channel is switched to pitched voice mode, it automatically displays the name of the voice which has been selected for playing as a pitched voice.

All the other rhythm kit parameters – those specifying how the voice will respond to MIDI key off, pitch bend, and control change messages – are available with pitched voices as well. However, these settings affect the entire channel rather than individual notes, and are therefore comparable to the rhythm kit's pitch bend range setting.

The most important difference between the pitched voice and rhythm kit structures is that the RM50 does not provide any memory banks for the storage of pitched voices, as it does for rhythm kits. As the above description shows, the pitched voice is composed of a mere handful of parameters. These may be best viewed as belonging to the channel rather than to the pitched voice. The RM50 is thus able to remember only sixteen sets of pitched voice parameters: one for each of the sixteen MIDI channels.



## Entering Setup Edit Mode

Let's take a look at the pitched voice parameters which have been set for one of your RM50's channels. On page 11 we brushed passed the pitched voice setup for channel 10. Let's go back and take a closer look at that setup now. If you've been following along with the preceding tutorials, your LCD should show the Play mode display for channel 10.

```
C10/Mode=rhythm kit  
Kit :I- 5 Test Kit <
```

Move the pointer to the channel mode in the upper left corner of the LCD, and change it to "pitched voice". You will see a display telling you that voice 49, "BA KillB", from the preset sound effects bank (P-SE), has already been selected for channel 10. This is a bass voice suitable for playing with the pitched voice channel mode.

```
C10/Mode=pitched voice<  
Vce :P-SE 49 BA KillB
```

To edit the pitched voice setup for channel 10, press the [EDIT] key. The red EDIT lamp to the left of the VOLUME control will light up, and a display like the following will appear in the LCD. (If the letters "VCE" in the upper left corner of the display are followed by a parameter name, press the [PAGE-] key and hold it until the display stops changing.)

```
VCE Note=C-2~C 8  
Vce :P-SE< 49 BA KillB
```

## Selecting a Voice

Now that we're in Setup Edit mode, let's select a different voice as the pitched voice for channel 10. Move the pointer to the bank name, then press the [+1/YES] key repeatedly to select the internal sound effects bank, I-SE.

```
vCE Note=C-2~C 8  
Vce :I-SE< 49 BA KillB
```

Next, move the pointer to the voice number and select voice 50, "BA Softa". This, like the preset voice which appeared as the default selection, is a bass guitar voice.

```
vCE Note=C-2~C 8  
Vce :I-SE< 50 BA Softa
```

## Channel Settings

You may recall that it is not necessary to enter Setup Edit mode to change the voice selection. You can produce the same results using the Play mode display, as described on page 12.

You will have to enter this mode, however, to change a channel's other pitched voice settings. We have described these settings in detail for rhythm kits in the preceding tutorial. Here, for thoroughness' sake, is a brief listing of the parameters available with the pitched voice channel mode.

Display	Function	Parameters
<pre>vCE/ATT Note=C-2~C 8 Uce : 0&lt;</pre>	Attenuation	Attenuation (1...15)
<pre>vCE/Koff Note=C-2~C 8 Key off message:accept&lt;</pre>	Key Off	Key off (accept, ignore)
<pre>vCE/PB Note=C-2~C 8 Range: 2&lt; Sw: on</pre>	Pitch Bend	Range (0...12) Switch (on, off)
<pre>vCE/Vol Note=C-2~C 8 on&lt;off off off off off</pre>	Control Change	Volume (on, off) Decay (on, off) Pan (on, off) Filter (on, off) Balance (on, off) Modulation (on, off)

Try locating each of these parameters, and change some of their values if you want. The methods for displaying, selecting, and changing the values of these parameters are the same as those described for rhythm kits. If you have trouble finding a parameter, refer back to the preceding tutorial.

As you move through the display pages, you will find that a row of dashes appears in the bottom row of the LCD for the Trigger Note Assign and Rhythm Kit Name functions. These functions are not available with the pitched voice channel mode.

## Editing Functions

Two of the final three Setup Edit mode functions – the Setup Initialize and Setup Recall operations – facilitate the process of editing a pitched voice setup. The procedures for accessing and using these functions are the same as described for rhythm kits.

```
vCE/Init?
I-SE 50 BA Softa
```

The Setup Initialize operation sets all pitched voice channel parameters to the default values listed on page 64.

```
vCE/Recall?
I-SE 50 BA Softa
```

The Setup Recall operation restores all pitched voice parameters to the values they had before you began editing. You've probably noticed that the pitched voice channel mode is represented by the letters "VCE" appearing in the upper left corner of the LCD. If you've changed any of the parameters for channel 10, the letter "V" will have changed to a small letter to indicate that the setup has been edited.

Unedited setup

```
VCE      Note=C-2~C 8  
Vce     :P-SE< 49 BA K111B
```

Edited setup

```
vCE      Note=C-2~C 8  
Vce     :I-SE< 49 BA K111B
```

You can use the Recall function to switch between the unedited and edited settings as long as the "v" is small. Once you begin editing the pitched voice setup for another channel, however, the setup data you last selected will become permanent, and further recall will be impossible.

You cannot use the Rhythm Kit Copy function when editing a pitched voice setup. As its name implies, this operation is only available with the rhythm kit channel mode. For this reason, a line of dashes will appear in the bottom row of the display when you select the Rhythm Kit Copy function while editing a pitched voice.

## Exiting Setup Edit Mode

To return to Play mode when you're finished editing a pitched voice setup, press either the [EXIT] key or the [PLAY] key. The RM50 will return to the Play mode display pictured at the beginning of this tutorial. The next time you enter Setup Edit mode to edit a rhythm kit or pitched voice, the LCD will display the Setup Edit page you last selected in this mode.

# Editing Voices

---

Your RM50 has six preset voice banks containing a total of 500 voices. The banks group these voices according to type: there are banks for bass drums, snare drums, toms, cymbals and hihats, percussion, and effect sounds. Each bank contains a wide selection of voices that should come close to meeting your needs for rhythm sound variety. (A complete listing of the RM50's preset voices is presented in the Appendix.)

You will doubtless want to edit the RM50's voices to suit them to your taste. Although you cannot change the preset voices, the RM50 also contains 500 voice variations and 128 user voices which you can. These voices offer a combination of sound capacity and architectural flexibility not matched by previous rhythm modules or drum machines. And if the RM50's huge internal voice capacity is still not enough for you, it is always possible to double it using a data card!

## RM50 Voice Types

As we mentioned in the preceding paragraph, the RM50 has two types of editable voices. Its **voice variations** let you create your own versions of the presets by changing a few simple parameters. These voices – which occupy the six of the seven internal voice banks (I-BD, I-SD, I-TM, I-CY, I-PC, and I-SE) – are useful when a slight modification or two will give you just the sound you need.

If you want to create a new voice totally unlike those we included as presets, then you must edit a **user voice** instead of a voice variation. Every user voice consists of one or two elements, each controlled by a wide variety of parameters which allow you to make either radical or subtle changes to the sounds they produce. You can also set these voices to be played alternately with each other – which is useful for voices such as open and closed hi-hat sounds which would normally not sound simultaneously – and assign their output to the RM50's INDIVIDUAL OUTPUT jacks.

One major difference between the RM50's variations and user voices, besides the number of parameters available, is the way in which they are managed within the RM50's memory. The variations have strict one-to-one relationships with the preset voices: every preset voice has an internal variation which bears the same voice number and name. Voice I-SD 15, "DR Tite2" is thus a variation of voice P-SD 15, "DR Tite2". The user voices, on the other hand, have no fixed order or relationship to the presets. The 128 internal user voices come initially programmed with exact copies of the first 128 presets – all of the 102 voices in bank P-BD, followed by voices 1 through 26 from bank P-SD – but you can feel free to copy voices from any bank to the user bank in order to edit their more detailed parameters.

The user voices also give you the option of creating entirely new sounds using the waveform data available on optional wave cards. This is something you cannot do with variations, which are limited to the RM50 preset waveforms used by the preset voices.

## Entering Voice Edit Mode

Now that you know about the difference between voice variations and user voices, let's start editing.

To edit a voice, you must first either assign it to a note in a rhythm kit, or select it for playing as a pitched voice. If you've been following along with these tutorials, you will recall that we selected voice I-SE 50, "BA Softa", as the pitched voice for channel 10 in the preceding tutorial.

```
C10/Mode=Pitched voice
Vce :I-SE 50 BA Softa<
```

It was not, strictly speaking, necessary to select an internal voice in order to edit the pitched voice setup for channel 10. However, that choice will now allow us to edit the voice itself.

The RM50 enters its Voice Edit mode by way of the Setup Edit mode we have studied in the last two tutorials. Press the [EDIT] key to enter this mode, and return the display to the first page of this mode, if necessary, by pressing and holding the [PAGE-] key.

```
vCE      Note=C-2~C 8
Vce :I-SE< 50 BA Softa
```

This page must be displayed in order for the RM50 to enter Voice Edit mode. Once you have displayed it, press the [EDIT] key a second time to enter that mode.

```
V/Easy/Vol [BA Softa]±²
      127<   +0   +0
```

A display like the one shown above should appear in the LCD. If the display is different, press the [PAGE-] key and hold it until the display stops changing.

## Basic Voice Structure

Before we begin discussing the meanings of the various parameters available in Voice Edit mode, let's take a quick look at the basic structure of an RM50 voice.

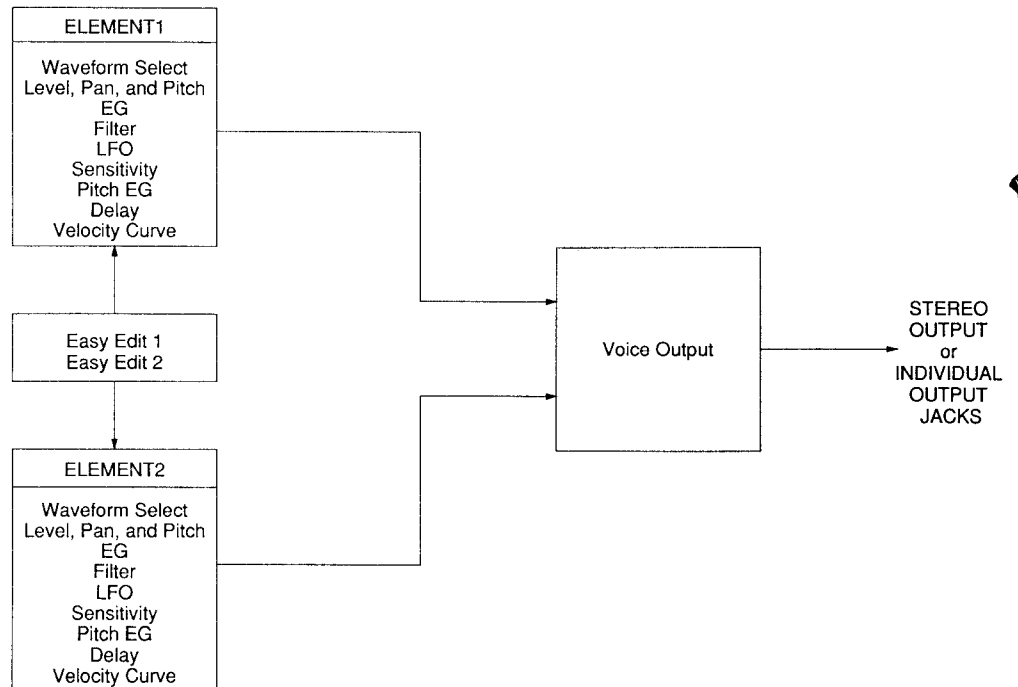

As this illustration shows, an RM50 voice consists of parameter settings for two different elements, each of which outputs a sound complete with a stereo position. Elements can be turned off to create a single-element voice. (A voice will produce no sound when both elements are turned off, of course.)

The signals output by the voice's one or two elements are adjusted as a whole by a group of settings known as the Easy Edit parameters. These parameters are so named because they allow you to make quick, simple adjustments to the overall character of a voice. You can edit these parameters for voice variations as well as user voices.

## Easy Edit Parameters

There are six Easy Edit parameters, occupying the first two pages of the Voice Edit mode display. Try locating these parameters using the methods described for the Setup Edit mode. As you will recall, you can use the [▷] key (or the [SHIFT] and [▷] keys) to move the pointer among the settings, and the [PAGE+] key to display a different page.

	DISPLAY	PARAMETER	DESCRIPTION
EASY EDIT 1	U/Easy/Vol [BA Softa]±± 127< +0 +0	Volume	Sets the voice's overall volume.
	U/Easy/Bal [BA Softa]±± 127 +0< +0	Balance	Adjusts the balance between the voice's two elements.
	U/Easy/Pan [BA Softa]±± 127 +0 +0<	Pan	Adjusts the stereo position of both voice elements.
EASY EDIT 2	U/Easy/Pch [BA Softa]±± +0< +0 +0	Pitch	Adjusts the pitch of both voice elements.
	U/Easy/Dcy [BA Softa]±± +0 +0< +0	Decay	Adjusts the decay time of both voice elements.
	U/Easy/Fil [BA Softa]±± +0 +0 +0<	Filter	Adjusts the cutoff frequencies of the filters applied to both voice elements.

As you can see, five of these parameters – volume, balance, pan, decay, and filter – are the same as those which can be changed by control messages turned on for the rhythm kit notes or pitched voice channels that play the voice. The remaining parameter is an offset which allows you to adjust the voice's overall pitch. (For more details on these parameters, see the descriptions of the Easy Edit functions on pages 72 and 73.)

Go ahead and try changing the values for each of these parameters and see how they affect the sound of the bass voice we've selected before moving on.

## Element Structure

Next, let's look at how a voice element is configured. The figure below depicts the basic element structure as a block diagram.

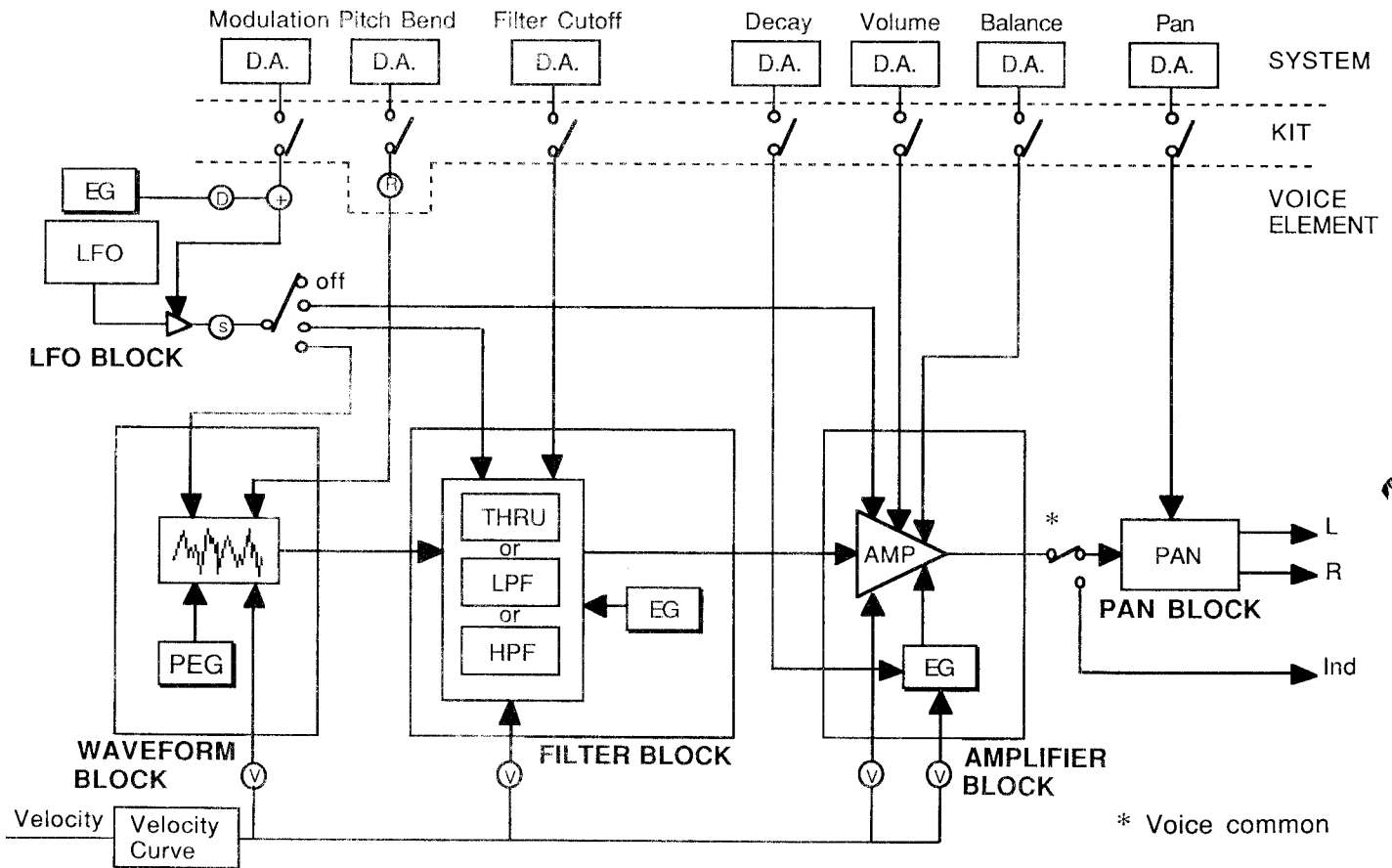

Every element begins with a **waveform block** consisting of a waveform selection plus a sub-block which controls its pitch. The RM50 gives you a wide selection of 133 preset waveforms to choose from. You can also create elements based on waveforms on wave cards you insert in the RM50's WAVEFORM slots. And if you have elected to add the optional wave RAM area to your RM50, you can use this area as a third source of waveforms.

The pitch at which the waveform plays is set by the element pitch parameter and modified by the Easy Edit pitch offset. Its basic pitch can be adjusted by many factors, such as the note number (when the voice is played as a pitched voice); a pitch envelope generator (PEG), which determines how the element's pitch changes over time; pitch modulation added by the LFO block; and MIDI pitch bend messages.

The output of the waveform block is modified by a **filter block**, which changes the **tone** of the element by removing frequencies from the upper or lower end of the output signal. The cutoff frequency – the frequency level at which filtering begins – is set by an Element Filter function and modified by the Easy Edit filter offset. It can be changed by factors such as control change messages and filter modulation added by the LFO block.

The filtered signal is input to an **amplifier block** which sets the volume of the output signal. The basic volume is set by an element volume parameter, and modified by the Easy Edit balance offset and volume parameters. It, too, can be adjusted by a variety of factors, including an amplifier EG which determines how the volume changes over time; volume modulation by the LFO block; and, perhaps most commonly, MIDI note velocity.

Connected to these three blocks is an **LFO block** which modulates the element's pitch, filter cutoff frequency, or volume using low frequency oscillation. The LFO can only be applied to one of these three blocks for any single element. The way in which it affects the other blocks is determined by a group of element LFO parameters. The modulation depth is adjusted by the Easy Edit modulation depth offset, as well as by modulation messages.

The final block in the element structure is a **pan block** which determines the element's stereo position. As with the other blocks, an element's pan can be affected by the Easy Edit pan offset and control change messages. Of course, the pan setting has no effect whatsoever when the element is output via the INDIVIDUAL OUTPUT jacks, represented by the letters "Ind" in the diagram.

## Selecting an Element to Edit

When you entered Voice Edit mode, you may have noticed a pair of small numerals in the upper right corner of the LCD. These numerals represent the voice's two elements. One of them will be underlined.

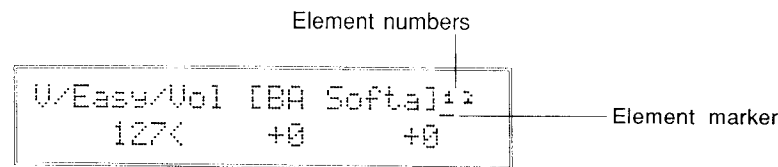

The underline marker tells you which element has been selected for editing. You can move the marker to the other element number, and thus display the parameter values for that element, by pressing the [SHIFT] and [EDIT] keys.

You can also turn an element off temporarily while editing by pressing either the [PAGE+] or the [PAGE-] key while holding down the [SHIFT] key. Muting an element in this fashion allows you to hear the sound produced by the other element alone. The number of element which is turned off will be displayed in reverse, as shown below:

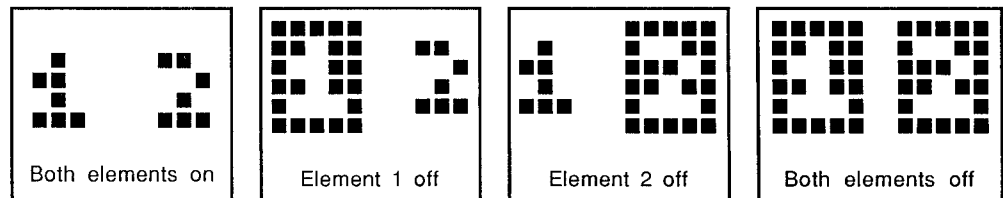

This muting is only temporary, however. If you want to turn an element off permanently, you must select "off" as the waveform for that element using the Waveform Select function, described below.



## Element Parameters

The RM50 offers a variety of element parameters so great that it fairly defies comparison with previous rhythm programmers and modules. We cannot hope to explain all of these parameters in this short tutorial; however, we present a brief list of the parameters, with notes indicating where each belongs on the element configuration diagram presented above.

Try locating each of these parameters in the RM50 display. (If you want to change them, you will first have to copy the voice to the internal user voice bank, I-MX, using the Voice Copy function described below.) As with Setup Edit mode, you can select display pages using the [PAGE+] and [PAGE-] keys, and move the pointer among the settings and parameters in each function using the [▷] key (or the [SHIFT] and [▷] keys).

DISPLAY	FUNCTION	PARAMETERS
U/Wave/Mem [BA Softa]±² PK132: SawWave F	Waveform Select	Memory Number Direction
U/Level [BA Softa]±² 63< (.....)16 +0000	Element Level, Pan, and Pitch	Level Pan Pitch
U/EG/Attack [BA Softa]±² 0< 35 27 0	Element EG	Attack Decay Release Punch
U/F1/Type [BA Softa]±² LPF12<11.6k 22 29 -59	Element Filter	Type Cutoff Resonance Rate Level
U/LFO/Dest [BA Softa]±² off<tri 0 0 0 0	Element LFO	Destination Wave Speed Delay Phase Depth
U/Sens/Lvl [BA Softa]±² +7< +0 +2 +4 0	Element Sensitivity	Level Pitch EG Filter Modulation
U/PEG/Rate [BA Softa]±² 0< +0	Element Pitch EG	Rate Level
U/Dly/Reps [BA Softa]±² 1< on 1 -1 -12.0	Element Delay	Repetition First note Time Level offset Pitch offset
U/VelCurve [BA Softa]±² 9: Easy2 <	Element Velocity Curve	Velocity curve

## Other Parameters

The twelfth and thirteenth pages of the Voice Edit mode display contain additional parameters which pertain to the entire voice rather than individual parameters.

```
U/Assign [BA Softa]±±  
Poly<off stereo 63
```

The Voice Output function contains four parameters which determine how the voice being edited is finally output from the RM50. Beginning at the left end of the display, the assign parameter specifies whether the voice is to be played as a monophonic or polyphonic voice. It includes “mono/alt” and “poly/alt” settings, which causes the two elements of a voice to play alternately rather than in unison. These two settings are useful, for example, when using a single voice consisting of two slightly different snare drum elements to simulate a drum roll.

The alternate group setting lets you assign the voice to one of seven alternate groups which identify sounds which should not be played at the same time. This parameter is used to prevent two voices from played simultaneously. It is typically used with open and closed hi-hat sounds, for example.

The output parameter determines whether the voice will be sent to the RM50's stereo OUTPUT jacks or its INDIVIDUAL OUTPUT jacks. Finally, the individual level parameter sets the output level of voices assigned to the INDIVIDUAL OUTPUT jacks by the output parameter.

```
U/Name [BA Softa]±±  
Voice Name =[BA Softa]
```

The Voice Name function assigns a name to the voice being edited. The procedure for assigning a name is the same as that described for rhythm kits on page 20.

## Editing Functions

The Voice Edit mode contains editing functions like those you saw in Setup Edit mode, to facilitate the voice editing process. The procedures for accessing and using these functions are the same as described on page 21 for rhythm kits. When editing voice variations, these functions only affect the Easy Edit parameters.

```
U/Init?  
I-SE 49 BA K111B
```

The Voice Initialize operation sets all of a voice's parameters, other than its name and waveform assignments, to their default values. These values are listed on page 84.

```
U/Recall?  
I-SE 49 BA K111B
```

The Voice Recall operation restores all parameters to the values they had before editing. Whereas the rhythm kit and pitched voice channel modes are indicated in Setup Edit mode by the letters “KIT” or “VCE” appearing in the upper left corner of the LCD, the Voice Edit mode is indicated by a single letter “V”. If you change any of the parameters for a voice, this “V” will change to a small letter to indicate that the voice has been edited.

Unedited voice

```
U/Easy/Vol [BA Softa]±>  
127< +0 +0
```

Edited voice

```
v/Easy/Vol [BA Softa]±>  
100< +0 +0
```

You can use the Voice Recall function to switch between the edited and unedited parameter values as long as the “v” is small. Once you start editing another voice, however, the voice data you last selected will become permanent, and further recall will be impossible.

```
U/Copy?  
to I-SE< 49 BA K111B
```

The Voice Copy operation copies a voice’s parameter values to the user voice bank. You will find this function useful when creating your own edited version of an existing voice. To copy a voice, you must specify whether you want to copy data to or from the currently selected voice bank and number. Because of the close relationship between the preset voices and the variations, you cannot use the copy function to copy data to a voice variation bank. You must therefore select “to” as the copy direction when editing a variation (or a preset voice, for that matter). You can use “from” as the direction when editing a user voice (bank I-MX or C-MX), as long as the destination you specify is another user voice. Detailed instructions for using this function are given on page 85.

## Exiting Voice Edit Mode

Press the [EXIT] key to return to the Setup Edit mode when you’re done editing a voice. To return to Play mode, press the [PLAY] key (or press the [EXIT] key twice). The next time you enter Voice Edit mode, the LCD will show the Voice Edit page you last selected in this mode.

# Using the Wave RAM Option

The RM50's wave RAM option lets you create a third source of waveform data, in addition to the RM50's preset waveforms and those on the wave cards you insert in its three WAVEFORM slots. If you have elected to install the SYEMB06 Expansion Memory Board in your RM50, you can copy waveforms from wave cards to the wave RAM area, or dump them from another device as MIDI sample dumps, and then use them to create completely new voices.

## What Is Wave RAM?

The SYEMB06 Expansion Memory Board is a 0.5 megabyte memory module which is installed beneath the hatch on the RM50's upper surface. The installation procedure is simple: you remove the two screws securing the hatch cover, insert the SYEMB06 in the revealed slot, and then replace the cover. (Be sure to read the instructions provided with the SYEMB06 before you attempt to install it, as they include some important cautions which you should observe in order to avoid damaging the SYEMB06 or your RM50.)

Once you have installed the SYEMB06, your RM50 will possess an internal wave RAM area capable of holding as many as 64 waveforms. The precise number of waveforms it can hold at any given time will depend on the size of the waveforms you load to it. These waveforms are selected during the voice editing process by choosing the internal (I) memory area in the Waveform Select function.

Do not forget that before you can use the wave RAM area, you must prepare it to hold data using the Wave RAM Initialize function included in the Wave RAM Utility group. This Initialize function is described briefly in the last paragraph of this tutorial.

## Copying Waveforms From a Card

To copy waveforms into the wave RAM area, you must first insert a wave card in one of the WAVEFORM slots on the RM50's front panel. Press the [UTILITY] key to enter Utility mode. You will see a display showing the name of a Utility mode function group, such as the one below.

```
UTL/System
Press "+1/YES" to enter
```

You must use the [PAGE+] or [PAGE-] keys to scroll through the names of the five function groups. You want to select the Wave RAM Utility group display shown below. (It is the fourth page of the Utility mode display.)

```
UTL/WaveRAM
Press "+1/YES" to enter
```

Press the [+1/YES] key to enter this utility group, then use the [PAGE+] or [PAGE-] keys to select the second display page for this group. (Utility mode display pages, like the Edit mode pages we have seen in previous tutorials, are always selected using the [PAGE+] or [PAGE-] keys. Also, as usual, any parameters in the display may be selected using the [▷] key or the [SHIFT] and [▷] keys.)

```
UTL/WaveRAM/Copy?
W1 1 ED1 > 1 ***<
```

This display lets you specify one of the three WAVEFORM slots as a source for waveform data, and select a waveform from the card in that slot. The name of the waveform will appear after its number. You can also choose one of 64 wave RAM waveform numbers as the destination for the waveform you are copying. Three asterisks will appear after the number of destinations that are empty: destinations containing data will show the first three letters of the waveform name.

When you are satisfied with your settings, press the [SHIFT] and [+1/YES] keys to copy the waveform. The RM50 will ask you if you're sure you want to copy the data.

```
UTL/WaveRAM/Copy Sure?
W1< 1 ED1 > 1 ***
```

You can press the [+1/YES] key at this point to go through with the copy operation, or the [-1/NO] or [EXIT] keys if you change your mind. If you copy the data, the RM50 will display a "completed" message to let you know when it's done. Press the [EXIT] key to clear this message, and go on to the next operation.

## Using Sample Dumps

You can load waveform data into the wave RAM area using MIDI sample dumps as well. The RM50 is capable of receiving sample dumps at any time, as long as the Demo Play function is not displayed. (Refer to the manual that came with the transmitting device for full instructions on the sample dump procedure.) Keep in mind, when dumping sample data to the RM50, that the sending device and the RM50 must be using the same device number.

Incoming samples are always assigned to the first available waveform number. Since a waveform name is not sent as part of the sample dump, the word "MIDI" followed by the sample number will be displayed as the waveform name. You may want to change this name to something more appropriate using the Waveform Name function described below.

The RM50 can receive sample dumps in two formats: the Yamaha TX16W format, and the standard sample dump format. Be sure to select the correct Sample Dump Mode setting, which appears as the last page of the Wave RAM Utility group, when transmitting sample dumps to your RM50.

## Other Wave RAM Utilities

The Wave RAM Utility group includes a few other functions which help you to organize the contents of your RM50's wave RAM area.

```
UTL/WaveRAM/Name
1<: MIDI-001
```

The Waveform Name function, which appears as the first page of the group, lets you name the waveforms you copy or dump to the wave RAM area. The procedure for naming a waveform is much the same as that described previously for rhythm kits and voices.

```
UTL/WaveRAM/Delete?  
I 1: MIDI-001<
```

The Waveform Delete function is displayed as the third page of the Wave RAM Utility group. You can use it to delete waveforms which you no longer need from the wave RAM area, should you need to open some space to hold a new waveform. Like the RM50's other executable functions, you can execute the Waveform Delete operation by pressing the [SHIFT] and [+1/YES] keys after selecting the waveform you want to delete.

```
UTL/WaveRAM/Memory  
488 kbyte available
```

You can find out how much of the wave RAM's capacity is open, and thus whether you need to clear some space by deleting waveforms, using the Wave RAM Memory function. This function simply displays, in kilobytes, the amount of wave RAM capacity available for waveform storage.

```
UTL/WaveRAM/Initialize?
```

The Wave RAM Initialize function, as we mentioned above, is used to initialize the wave RAM area after you install the SYEMB06 expansion memory board in the RM50. You can also use this function to clear all waveforms from the wave RAM at once, should you wish to do so.

```
UTL/WaveRAM/SampleDump  
Mode = normal<
```

Finally, the Sample Dump Mode function selects between the two sample dump formats handled by the RM50. Use the "TX16W" setting when dumping Yamaha TX16W samples, and the "normal" setting when dumping samples from any other device.

### Exiting the Wave RAM Utility Group

When you are done using the Wave RAM Utility functions, you can press the [EXIT] key once to return to the Utility mode function group display if you wish to use a different Utility function group, or twice to return to Play mode.

# Using Audio Triggers

If you will use the RM50's audio trigger input function, you should be forewarned that it is not enough just to plug your triggers into the jacks on the RM50's rear panel. Before you can use the RM50 as an electronic drum module, you will have to select the rhythm kit notes played by each trigger.

You will also have to fine-tune the RM50's Trigger function settings to make sure that the signals are being received with adequate efficiency. The precise settings you must use will depend, among other things, on the trigger and drum equipment you use, the conditions you will be playing under, and your playing style.

## Assigning Notes to Triggers

Every RM50 rhythm kit contains a set of six parameters, each of which assign a rhythm kit note to one of the trigger inputs. These parameters are found on the sixth page of the Setup Edit mode display, a page which we skipped past when we discussed the rhythm kit editing process earlier.

Let's try selecting this display. First, return to the Play mode display – if you have not done so already – and select the setup MIDI channel 1. (The trigger inputs are set by default to use this channel.)

```
CG1<Mode=rhythm kit
Kit :P- 1 Rock 1
```

Next press the [EDIT] key, and then use the [PAGE+] or [PAGE-] keys to select the display shown below.

```
KIT/TriggerNote
#5<: Note=G 1( 43)
```

The number at the left end of the LCD's lower row is the number of the currently selected trigger. The note to its right is the rhythm kit note which will be played by that trigger. The RM50's preset rhythm kits all assign notes to triggers in the following manner:

TRIGGER	#1	#2	#3	#4	#5	#6
NOTE	C1 (36)	D1 (38)	D2 (50)	B1 (47)	G1 (43)	F1 (41)

Since each rhythm kit assigns different voices to every note, it is difficult to say exactly what sort of voice will be played by a trigger. You will probably want to adjust the note assignments for every rhythm kit you use.

You can do so by selecting each trigger in turn, then selecting the note you want it to play. Normally, you will do this by pressing the [▷] key to move the pointer back and forth between the trigger number and the note parameter, and using the [+1/YES] and [-1/NO] keys to raise or lower their settings. However, you can speed the process by using the Display Chase function, which we described above on page 17.

When the Display Chase function is activated, the RM50 display will automatically shift in response to the signals received by the trigger inputs, just as it changed to show the settings for notes received at the MIDI IN terminal. Using this function, you can eliminate the need to move the cursor back and forth between the trigger and note settings in the Trigger Note Assign display page. (The Display Chase function also works with the Utility mode Trigger Input functions described below.)

## Adjusting the Gain

Now that you have assigned a rhythm kit note to each of the trigger inputs, you should check to make sure that the RM50 is properly converting the received signals into MIDI data. The procedure for doing this is outlined here briefly.

1. Turn the Display Chase function on, if you have not done so already. The procedure for turning this function on has already been described on page 17.
2. Press the [UTILITY] key to enter Utility mode, and then use the [PAGE-] key (if necessary) to select the System Utility function group.

```
UTL/System
Press "+1/YES" to enter
```

Press the [+1/YES] key to enter this group, and then press the [PAGE-] key repeatedly, if necessary, to display the Trigger Input 1 function, shown below.

```
UTL/Sys/Trig/Trig No.
#1<:   99   on fast
```

3. Press the [SHIFT] and [PLAY] keys to show the Input Monitor display.

```
InputMoni  Ch Note Vel
           1   36  80
```

This display shows the note played by trigger input signals, and the number of the audio trigger which played the note. It also shows the velocity of the note as both a number and a horizontal bar graph. You will want to keep your eye on the bar graph during the next two steps.

4. Tap a connected drum or drum pad. The bar graph should show low velocities when you tap lightly, and peak when you are playing your hardest.

```
InputMoni  Ch Note Vel
           1   36  32
```

```
InputMoni  Ch Note Vel
           1   36 127
```



If the displayed velocities are too low or too high, you must adjust the trigger's gain. To do so, press the [EXIT] key once to return to the Trigger Input 1 display. The gain parameter is the first parameter after the trigger number in the lower row of this display. Raise its value to increase the gain for higher velocities, or lower it to decrease the gain.

```

UTL/Sys/Trig/Gain
#1 :    99<  on fast
  
```

Raise to increase gain, or lower to decrease.

Then press the [SHIFT] and [PLAY] keys again to return to the Input Monitor display and check the result of your adjustment. If you find that the trigger does not produce sufficient velocity even when the gain parameter is set to its maximum value of 99, you should set the gain attenuation parameter (the second parameter in the Utility mode display) to "off" and then readjust the gain.

```

UTL/Sys/Trig/Atn
#1 :    99  on< fast
  
```

Turn off if velocity is insufficient.

Continue switching between the Trigger Input 1 and Input Monitor displays until you are satisfied with the gain setting.

5. Next, tap the drum or pad several times with roughly the same amount of force. Each tap should produce roughly the same velocity.

```

InputMoni  Ch Note Vel
|||||||    1  36  80
  
```

```

InputMoni  Ch Note Vel
|||||||    1  36  84
  
```

If the velocity varies widely from tap to tap, or if the velocity tends to drop to a level much lower than force actually used from time to time, then the RM50 is scanning too fast. If this happens, set the scan speed – the last parameter in the Trigger Input 1 display – to "slow". (You will also want to use the slow scan speed when the RM50 is receiving trigger input from audio equipment, such as a multitrack recorder, rather than drum pads.)

```
UTL/Sys/Trig/Scan
#1 :    99    on fast<
```

Set to "slow" to prevent sporadic drops in velocity.

If you find you need a faster response and can put up with some minor fluctuations in level, however, you should probably use the "fast" setting.

Once you are satisfied with the velocity information produced by the first trigger, repeat this procedure for each of the remaining triggers.

## Reducing Interference

The Trigger Input 2 function, found on the second page of the System Utility function group, contains parameters which help to compensate for interference to the trigger signals.

```
UTL/Sys/Trig/SelfRej
#1 :    4<    0    3
```

The self reject parameter helps to eliminate spurious triggering caused by vibrations of the drum head. When set too high, however, it can reduce the trigger's sensitivity to flams and other fast techniques. Raise the value of this parameter if a single strike of the drum produces two notes. Lower it if the RM50 does not play enough notes in response to fast techniques.

```
UTL/Sys/Trig/NoiseRej
#1 :    4    0<    3
```

The noise reject parameter reduces spurious triggering caused by background noise. When set too high, however, it can reduce the trigger's sensitivity to soft notes. Raise its value if the RM50 seems to play notes for no reason at all. Lower it if the RM50 does not play in response to soft notes.

```
UTL/Sys/Trig/CrossRej
#1 :    4    0    3<
```

The crosstalk reject parameter sets the level at which the RM50 filters out crosstalk from drums transmitting on the other triggers. Raise this setting if a trigger causes the RM50 to play notes assigned to other triggers. When raised too high, however, this parameter can cause the RM50 to ignore techniques such as two-drum flams.

## MIDI Data Settings

The last Trigger Input function, accessed by another press of the [PAGE+] key, contains settings which determine how the RM50 generates MIDI data in response to received trigger signals.

```
UTL/Sys/Trig/Trig No.  
#1<: 2   60  10  Linear
```

The first parameter following the trigger number in the lower row of the display selects the MIDI channel on which the trigger will transmit its MIDI data. As we mentioned above, all six of the triggers are set to use channel 1 as their default channel. If you wish, however, you can change this setting so that each of the triggers will transmit on a different channel. (This will cause the RM50 to play notes in different rhythm kits in response to signals received from different triggers.) The RM50 will also transmit MIDI note information on the specified channels from its MIDI OUT terminal in response to trigger input.

If a trigger is set to play on a channel using the pitched voice channel mode, the RM50 will play the voice using the note specified by the second parameter in this display. If the trigger is set to a channel whose channel mode is set to "off", the RM50 will not play any notes; it will merely transmit the note specified by the second parameter from its MIDI OUT terminal for use by receiving MIDI devices.

The remaining two parameters in this display set the gate time and velocity curve which the trigger uses to generate note off messages and note velocity information. These settings are described in detail on pages 93 and 94.

## Exiting the System Utility Group

The procedure for exiting the System Utility function group is the same as that described above for the Wave RAM Utility group. Press the [EXIT] key once to return to the Utility mode function group display, or twice to return to the Play mode display.

# Using Macros

As you become more familiar with the RM50 and learn to use its many features, you may find that you need to access some functions more frequently than others. The RM50's key macro feature lets you record up to ten macros that help you to get to the functions you use most often by simply pressing a couple of keys.

## Playing a Macro

As an example of how macros can speed your access to the RM50's functions, let's look back at the first procedure you used when you began reading these tutorials: that we described on pages 8 and 9, for accessing the Demo Play function. If you tried this procedure immediately after purchasing your RM50, you must have made seven keystrokes to start the demo song playing:

[UTILITY]	to enter Utility Mode
[PAGE+] x4	to display the Demo Utility
[+1/YES]	to enter the Demo Utility
[+1/YES]	to start playback

Seven keystrokes may not seem like a lot. But there's an easier way to start the RM50's demo songs playing, one which we have kept secret until now. First, press the [MACRO] key.

```
MACRO: PLAY=[Demo Play ]
Push panel switch
```

A display like this will appear whenever you press the [MACRO] key. The display is prompting you to execute a macro by pressing one of the RM50's keys. Try pressing the [PLAY] key at this point.

```
UTL/Demo
Play<Pre Song1:SKINBIT
```

All of a sudden, the RM50 demo songs are playing! You have just executed with two keystrokes a function that previously required seven!

This may seem only moderately convenient, but it is, after all, a mild example. Depending on which functions and parameters you last accessed in each mode, you may find you have to make twenty-five keystrokes to get from Play mode to a certain desired parameter in a Voice Edit mode function. If you have to do this with any frequency, it may begin to seem as though you are spending too much of your editing time pressing keys needlessly.

The RM50 comes programmed with ten macros that should give you an idea of the sorts of things you can do with this function. Take a few moments to try each of the macros in the list below, then try duplicating their action manually. This little exercise should give you a good idea just how handy they can be.

Number	Key	MacroName
1	PLAY	Demo Play
2	EDIT	Kit Copy
3	UTILITY	Voice Copy
4	PAGE-	Easy Pitch
5	PAGE+	Level Sens
6	-1/NO	Card Save
7	+1/YES	Trans Bulk
8	CURSOR	Click on
9	EXIT	Click off
10	SOUND	Sound Vel

## Recording a Macro

Of course, you may decide that you won't be using the functions selected by these preset macros all that much. If this is the case, feel free to record your own macros. By putting this feature to work, you can customize your RM50 to make routine programming tasks a little smoother, so you can direct more of your attention to the musical tasks at hand.

It's easy to record macros. Start by pressing the [MACRO] key while holding down the [SHIFT] key. You should see a display like the one below. (If you don't, press the [SHIFT] and [-1/NO] keys once or twice).

```
KEY MACRO/Mode= record
Macro key = PLAY(1)<
```

The pointer has appeared next to a key name and number representing the RM50 key that you will use to play the macro you are about to record. Use the [+1/YES] or [-1/NO] keys to select a different macro key, if you wish. (We'll pick the [SOUND] key here, for the purpose of our example.)

```
KEY MACRO/Mode= record
Macro key = SOUND(10)<
```

Next, press the [SHIFT] and [MACRO] keys once again to begin recording. The LCD will shift to the familiar Play mode display.

```
C01<Mode=rhythm kit
Kit :I- 1 Rock 1
```

Reversed "m"

This display has a reversed "m" in the upper right corner, indicating that a macro is now being recorded. Execute the macro operation exactly as you want it to be played back, then press the [MACRO] key to end the recording.

There are a few things you should keep in mind when recording a macro. First, RM50 macros always begin in Play mode. Also, whenever you enter a mode (or a function group, in Utility mode), the RM50 will always display the first page of that mode. Likewise, the pointer will always appear at the first setting parameter in any display. This is a little different from the RM50's normal operation mode, which normally leaves all of the mode displays and pointer positions sent to the pages and parameters you edited last.

A macro can record up to 50 keystrokes. (Combination keystrokes using the [SHIFT] key are counted as a single keystroke.) You cannot press the [SHIFT] and [MACRO] keys, as part of a macro. Pressing the [MACRO] key will of course end the macro and cause the RM50 to leave the record mode. The macro will also end automatically if you start a demo song using the Demo Play function.

## Other Macro Functions

In addition to the Macro Record function, the RM50 lets you view the contents of the macros you have recorded, and assign them names that will help you to remember what they do. You can access both of these functions in the same way as the Macro Record function, by pressing the [SHIFT] and [MACRO] keys simultaneously.

From the Macro Record display shown above, press the [SHIFT] and [+1/YES] keys once to select Macro View, or twice to select the Macro Name. Then, in the same manner as the Macro Record function, select the key corresponding to the macro that you want to view. Use the [+1/YES] or [-1/NO] keys to select different macro, if you wish, then press the [SHIFT] and [MACRO] keys to view or name it. Press the [MACRO] key to exit when you're done using either of these functions.

```
KEY MACRO/Mode= view
1:step 1=[UTILITY ]
```

The Macro View display above shows the first step of the Demo Play macro we played at the start of this tutorial. The step number is followed in the display by the name of the key that was pressed as the first step of the macro. You can use the [+1/YES] or [-1/NO] keys to scroll through the steps of the macro.

```
KEY MACRO/Mode= name
PLAY= [Click off ]
```

The Macro Name display allows you to input a name that the RM50 will display when you are selecting a macro to play back. The method used to input the name is exactly the same as that used to name rhythm kits, voices, and waveforms.

If you forget which key a macro is assigned to, you can display the names of the macros before you play them back. Press the [MACRO] key to enter the macro playback mode, then press the [+1/YES] or [-1/NO] keys while holding down the [SHIFT] key to find the name of the desired macro.

