

Technics

KEYBOARD

SX-KN720

SX-KN920

SX-KN1500

SX-KN930





[KN1500]

FOR YOUR SAFETY PLEASE READ THE FOLLOWING TEXT CAREFULLY. (for UNITED KINGDOM)

This appliance is supplied with a moulded three-pin mains plug for your safety and convenience.

A 5 amp fuse is fitted in this plug.

Should the fuse need to be replaced please ensure that the replacement fuse has a rating of 5 amps and that it is approved by ASTA or BSI to BS1362. Check for the ASTA mark  or the BSI mark  on the body of the fuse.

If the plug contains a removable fuse cover you must ensure that it is refitted when the fuse is replaced.

If you lose the fuse cover the plug must not be used until a replacement cover is obtained.

A replacement fuse cover can be purchased from your local Panasonic/Technics Dealer.

IF THE FITTED MOULDED PLUG IS UNSUITABLE FOR THE SOCKET OUTLET IN YOUR HOME THEN THE FUSE SHOULD BE REMOVED AND THE PLUG CUT OFF AND DISPOSED OF SAFELY.

THERE IS A DANGER OF SEVERE ELECTRICAL SHOCK IF THE CUT-OFF PLUG IS INSERTED INTO ANY 13 AMP SOCKET.

If a new plug is to be fitted please observe the wiring code as shown below.

If in any doubt please consult a qualified electrician.

IMPORTANT: —The wires in this mains lead are coloured in accordance with the following code:—

Blue: Neutral
Brown: Live

As the colours of the wires in the mains lead of this appliance may not correspond with the coloured markings identifying the terminals in your plug, proceed as follows.

The wire which is coloured BLUE must be connected to the terminal in the plug which is marked with the letter N or coloured BLACK.

The wire which is coloured BROWN must be connected to the terminal in the plug which is marked with the letter L or coloured RED.

Under no circumstances should either of these wires be connected to the earth terminal of the three-pin plug, marked with the letter E or the Earth Symbol .

How to replace the fuse. Open the fuse compartment with a screwdriver and replace the fuse and fuse cover.

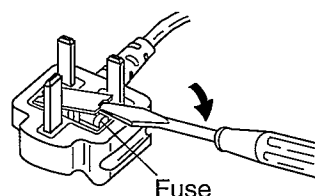

Technics

OWNER'S MANUAL



Caution (KN1500)

Voltage (except North America, Mexico, Europe, Australia, New Zealand, Singapore and Philippines)

Be sure the voltage adjuster located on the rear panel is in accordance with local voltage in your area before using this unit. Use a screwdriver to set the voltage adjuster to the local voltage.

WARNING: TO REDUCE THE RISK OF FIRE OR ELECTRICAL SHOCK, DO NOT EXPOSE THIS PRODUCT TO RAIN OR MOISTURE.

BEFORE YOU PLAY, PLEASE READ THE CAUTIONARY COPY APPEARING ON PAGES 2 AND 3.

	CAUTION RISK OF ELECTRIC SHOCK DO NOT OPEN	
CAUTION:	TO REDUCE THE RISK OF ELECTRIC SHOCK, DO NOT REMOVE SCREWS. NO USER-SERVICEABLE PARTS INSIDE. REFER SERVICING TO QUALIFIED SERVICE PERSONNEL.	



The lightning flash with arrowhead symbol, within an equilateral triangle, is intended to alert the user to the presence of uninsulated "dangerous voltage" within the product's enclosure that may be of sufficient magnitude to constitute a risk of electric shock to persons.



The exclamation point within an equilateral triangle is intended to alert the user to the presence of important operating and maintenance (servicing) instructions in the literature accompanying the appliance.

Before you play

For long and pleasurable use of this instrument, and to gain a thorough understanding of your KN Keyboard, it is strongly recommended that you read through this Owner's Manual once.

The Owner's Manual is comprised of the following parts.

BASIC FUNCTIONS

This part includes an explanation of basic procedures and points you should be aware of for proper operation of your instrument.

PRACTICAL APPLICATIONS

This part comprises a detailed explanation of sound, effect, rhythm, **SEQUENCER**, **COMPOSER**, Disk Drive, MIDI, etc.

REFERENCE GUIDE (separate booklet)

Reference guide for the contents of the **SOUND**, **RHYTHM**, MIDI data, etc.

Cautions for safest use of this unit

(KN720/KN920)

Installation location

1. A well-ventilated place.
Take care not to use this unit in a place where it will not receive sufficient ventilation, and not to permit the ventilation holes to be covered by curtains, or any similar materials.
2. Place away from direct sunlight and excessive heat from heating equipment.
3. A place where humidity, vibration and dust are minimized.

Metal items inside the unit may result in electric shock or damage.

Do not permit metal articles to get inside the unit.

Be especially careful with regard to this point if children are near this unit. They should be warned never to try to put anything inside.

If, nevertheless, some such article does get inside, contact the store where the unit was purchased.

If water gets into the unit

Contact the store where the unit was purchased.

As a precaution, it is suggested that flower vases and other containers which hold liquids not be placed on the top of this unit.

If operation seems abnormal

Immediately turn off the power, and contact the store where it was purchased.

Discontinue using the unit at once. Failure to do so may result in additional damage or some other unexpected damage or accident.

- Because the power amp is located inside the unit, it is normal for the cabinet to become warm.

Don't touch the inside parts of this unit.

Some places inside this unit have high voltage potential. Never try to remove the top or back panels of this unit, or to touch inside parts by hand or with tools.

Contact someone who is qualified in order to inspect the inside, or to replace a fuse, if such becomes necessary. Never attempt to do these things yourself.

Maintenance

The following suggestions will assist you in keeping the unit in top condition.

- Be sure to switch the instrument off after use, and do not switch the unit on and off in quick succession, as this places an undue load on the electronic components.
- To keep the luster of the surface and buttons, simply use a clean, damp cloth; polish with a soft, dry cloth. Polish may be used but do not use thinners or petro-chemical-based polishes.
- A wax-based polish may be used on the cabinet, although you will find that rubbing with a soft cloth will suffice.

When using the AC adaptor

Power source

1. Be sure the line voltage selector is in accordance with local voltage in your area before connecting the plug to the socket.
2. DC power cannot be used.
3. Unplug the power cord if the unit will not be used for a long time.

Handling the power cord

1. Never touch the power cord, or its plug, with wet hands.
2. Don't pull the power cord.

A word about the power cord

If the power cord is scarred, is partially cut or broken, or has a bad contact, it may cause a fire or serious electrical shock if used. NEVER use a damaged power cord for any appliance. Moreover, the power cord should never be forcibly bent.

**SERVICE MUST BE CARRIED OUT BY DEALER
OR OTHER QUALIFIED PERSON**

Cautions for safest use of this unit (KN1500)

Installation location

1. A well-ventilated place.
Take care not to use this unit in a place where it will not receive sufficient ventilation, and not to permit the ventilation holes to be covered by curtains, or any similar materials.
2. Place away from direct sunlight and excessive heat from heating equipment.
3. A place where humidity, vibration and dust are minimized.

Power source

1. Be sure the line voltage selector is in accordance with local voltage in your area before connecting the plug to the socket.
2. DC power cannot be used.

Handling the power cord

1. Never touch the power cord, or its plug, with wet hands.
2. Don't pull the power cord.

Metal items inside the unit may result in electric shock or damage.

Do not permit metal articles to get inside the unit.

Be especially careful with regard to this point if children are near this unit. They should be warned never to try to put anything inside.

If, nevertheless, some such article does get inside, disconnect the power cord plug from the electrical outlet, and contact the store where the unit was purchased.

If water gets into the unit

Disconnect the power cord plug from the electrical outlet, and contact the store where it was purchased.

As a precaution, it is suggested that flower vases and other containers which hold liquids not be placed on the top of this unit.

If operation seems abnormal

Immediately turn off the power, disconnect the power cord plug from the electrical outlet, and contact the store where it was purchased. Discontinue using the unit at once. Failure to do so may result in additional damage or some other unexpected damage or accident.

- Because the power source is located inside the unit, it is normal for the cabinet to become warm.

A word about the power cord

If the power cord is scarred, is partially cut or broken, or has a bad contact, it may cause a fire or serious electrical shock if used. NEVER use a damaged power cord for any appliance. Moreover, the power cord should never be forcibly bent.

Don't touch the inside parts of this unit.

Some places inside this unit have high voltage potential. Never try to remove the top or back panels of this unit, or to touch inside parts by hand or with tools.

Contact someone who is qualified in order to inspect the inside, or to replace a fuse, if such becomes necessary. Never attempt to do these things yourself.

Maintenance

The following suggestions will assist you in keeping the unit in top condition.

- Be sure to switch the instrument off after use, and do not switch the unit on and off in quick succession, as this places an undue load on the electronic components.
- To keep the luster of the surface and buttons, simply use a clean, damp cloth; polish with a soft, dry cloth. Polish may be used but do not use thinners or petro-chemical-based polishes.
- A wax-based polish may be used on the cabinet, although you will find that rubbing with a soft cloth will suffice.

**SERVICE MUST BE CARRIED OUT BY DEALER
OR OTHER QUALIFIED PERSON**

Contents

Cautions for safest use of this unit (KN720/KN920)	2
Cautions for safest use of this unit (KN1500)	3
Controls and functions (KN720)	6
Controls and functions (KN920)	8
Controls and functions (KN1500)	10

BASIC FUNCTIONS

Getting started (KN720/KN920)	12
Getting started (KN1500)	14
Listen to the demonstration	16
Selecting sounds	17
Add effects	18
Playing automatic rhythms (KN720)	20
Playing automatic rhythms (KN920/KN1500)	22
Automatic accompaniment	24
Record your performance	26
Playing commercial disks (KN920/KN1500)	28

PRACTICAL APPLICATIONS

About the display	30
Part I Sounds and effects	35
Selecting sounds	35
Assigning parts to the keyboard	36
Effects	38
Transpose	41
Techni-chord	42
Part II Manual Sequence Pads	44
Playing phrases	44
Record a phrase	45
Part III Playing the rhythm	46
Selecting rhythms	46
Playing the rhythm	48
Auto Play Chord	49
Sound Arranger	52
One Touch Play	53
Music Style Select (KN1500)	54
Music Style Arranger (KN920/KN1500)	55
Panel Memory	56
Foot Switch setting	58
Part IV Sequencer	59
Outline of the Sequencer	59
Song	61
Easy Record	62
Sequencer parts	63
Realtime Record	64
Sequencer Play	66

Step Record	68
Track Assign	72
Editing the recorded performance	73
Sequencer Medley	76
Part V Composer (KN920/KN1500)	77
Outline of the Composer	77
Edit a preset rhythm pattern: preparation	79
Create a completely new rhythm: preparation	80
Record your rhythm pattern	82
Playback	83
Composer mode	83
Bend Range	84
Composer Chord Map	85
Part VI Song memory (KN720)	87
Store your performance	87
Recall the stored performance	88
Part VII Disk Drive (KN920/KN1500)	89
Outline of the Disk Drive function	89
Outline of procedure	90
Loading data	91
Playing commercial disks	95
Formatting a disk	96
Saving data	97
Part VIII Adjusting the sounds	101
Outline of the Sound Setting mode	101
Part Setting	102
Touch & Tune	103
Key Scaling	104
Left Hold	105
Part IX Creating sounds (KN920/KN1500)	106
Outline of the Sound Edit	106
Setting the function	107
Part X MIDI	111
What is MIDI?	111
Outline of MIDI functions	113
Setting the functions	114
Initialize	122
Options	123
Connections	124
Symptoms which appear to be signs of trouble	125
Error messages	127
Index	129
Specifications	131

Controls and functions (KN720)

SEQUENCER

Record and play back your performance.
(Refer to page 59.)

AUTO PLAY CHORD

Add an automatic accompaniment to your selected rhythm.
(Refer to page 49.)

DISPLAY

Displays performance information, function settings and other messages.
(Refer to page 30.)

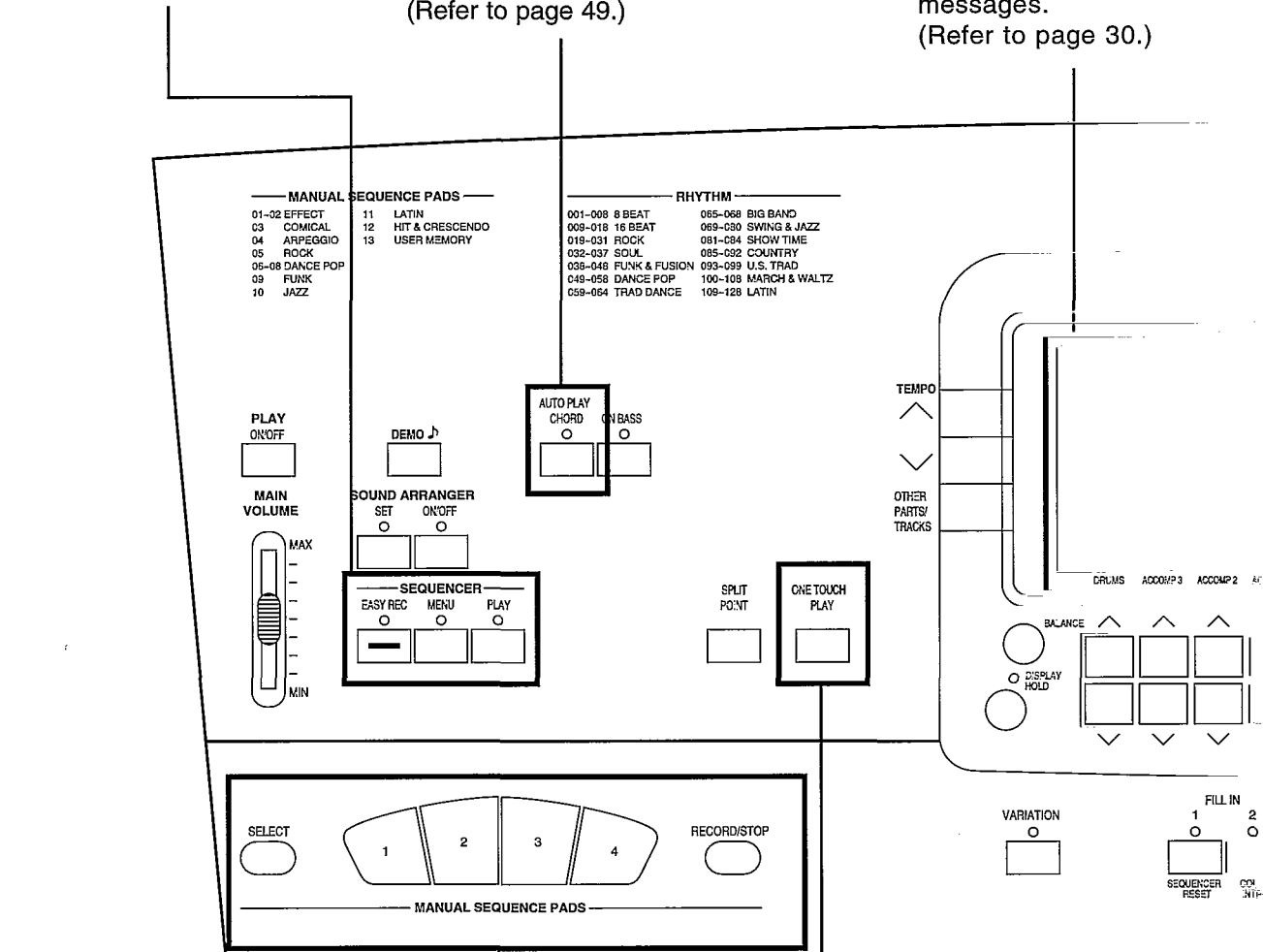

PITCH BEND

The **PITCH BEND** wheel allows a "sliding" change in the pitch.
(Refer to page 40.)

MANUAL SEQUENCE PADS

Add various phrases to your performance with the pad buttons.
(Refer to page 44.)

ONE TOUCH PLAY

Sounds and effects matching the selected rhythm are automatically set.
(Refer to page 53.)

TRANSPOSE

Raise or lower the key of the entire keyboard.
(Refer to page 41.)

Number pad

Use the number pad to select sounds and rhythms by their numbers.
(Refer to pages 35 and 46.)

Effects

Add various effects to the sounds.
(Refer to page 38.)

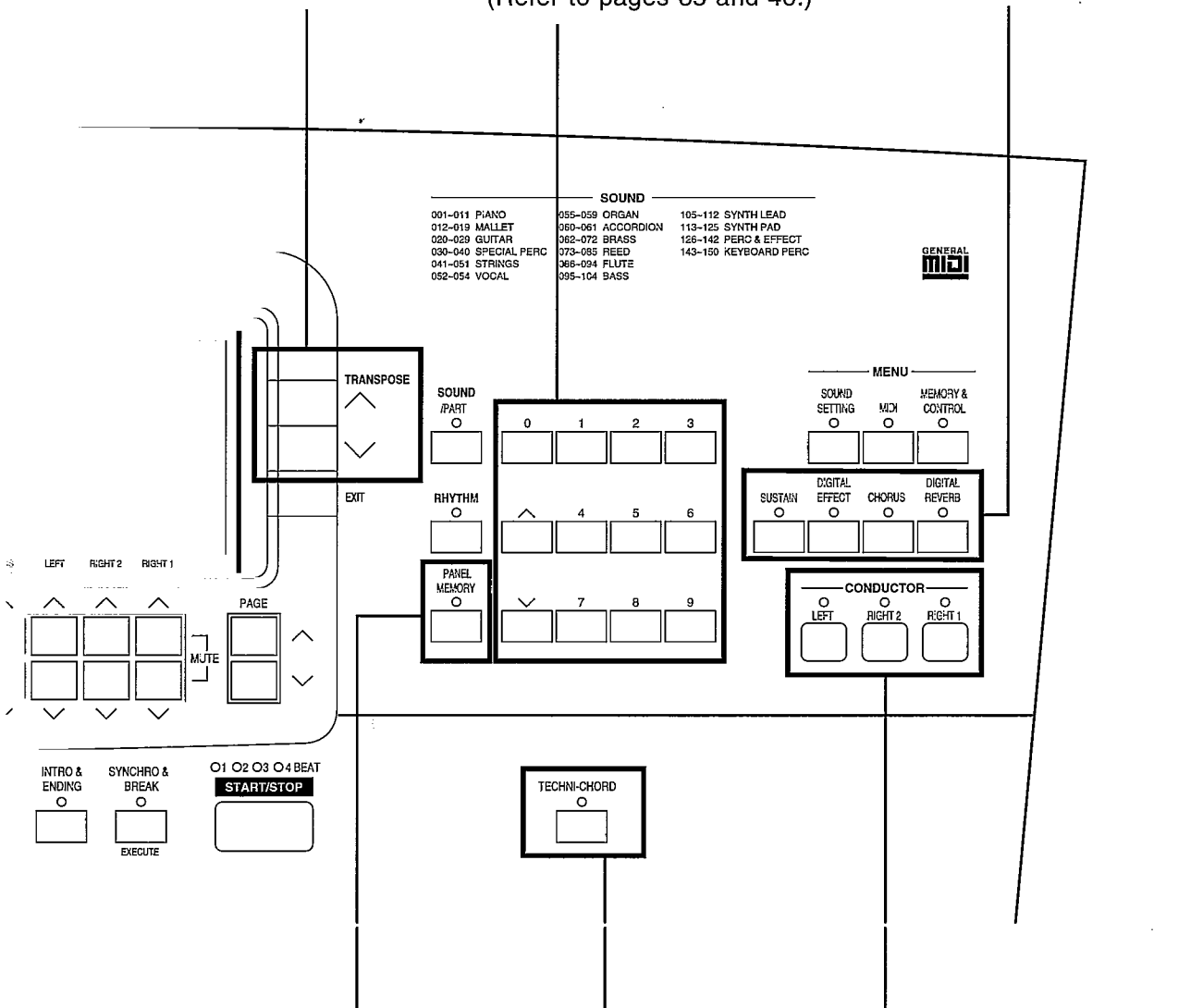

PANEL MEMORY

Store the panel settings, then recall them instantaneously just by pressing a button or two.
(Refer to page 56.)

TECHNI-CHORD

Block chords are automatically added to the melody.
(Refer to page 42.)

CONDUCTOR

Assign a different sound to each part, then assign the desired parts to sections of the keyboard.
(Refer to page 36.)

Backup memory

The various stored memories and function settings are preserved even if the **PLAY** button is turned off, as long as power is being supplied through the AC adaptor or the batteries.
If the power supply to this instrument is discontinued (either through the AC adaptor or the batteries), the various memories and settings will be cleared after about 10 minutes.

Controls and functions (KN920)

SEQUENCER

Record and play back your performance.
(Refer to page 59.)

COMPOSER

Create and store original rhythm patterns.
(Refer to page 77.)

AUTO PLAY CHORD

Add an automatic accompaniment to your selected rhythm.
(Refer to page 49.)

DISPLAY

Displays performance information, function settings and other messages.
(Refer to page 30.)

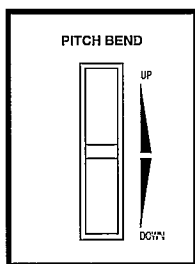
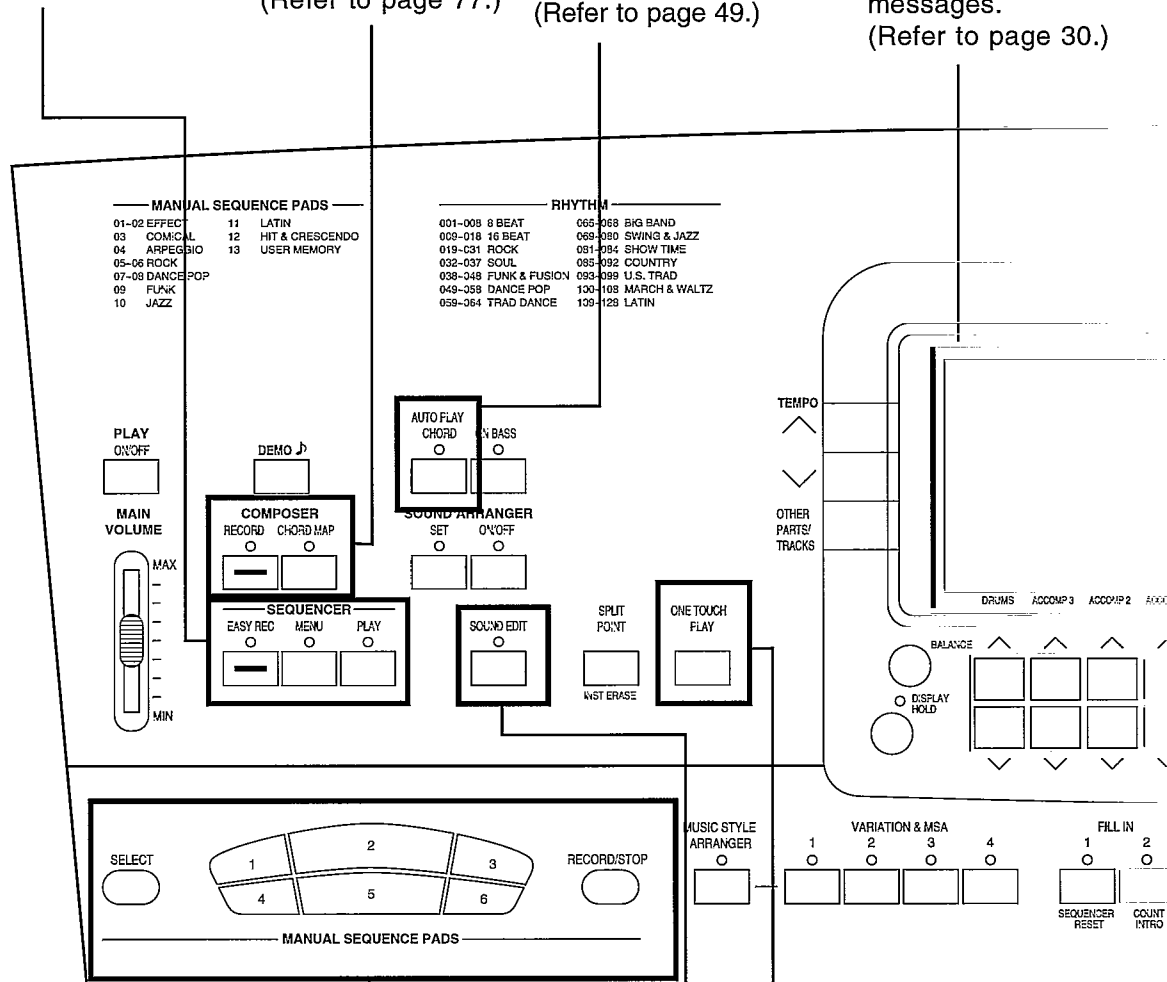

PITCH BEND

The **PITCH BEND** wheel allows a “sliding” change in the pitch.
(Refer to page 40.)

MANUAL SEQUENCE PADS

Add various phrases to your performance with the pad buttons.
(Refer to page 44.)

ONE TOUCH PLAY

Sounds and effects matching the selected rhythm are automatically set.
(Refer to page 53.)

SOUND EDIT

Modify preset sounds to create new and unique sounds.
(Refer to page 106.)

TRANSPOSE

Raise or lower the key of the entire keyboard.
(Refer to page 41.)

Number pad

Use the number pad to select sounds and rhythms by their numbers.
(Refer to pages 35 and 46.)

Effects

Add various effects to the sounds.
(Refer to page 38.)

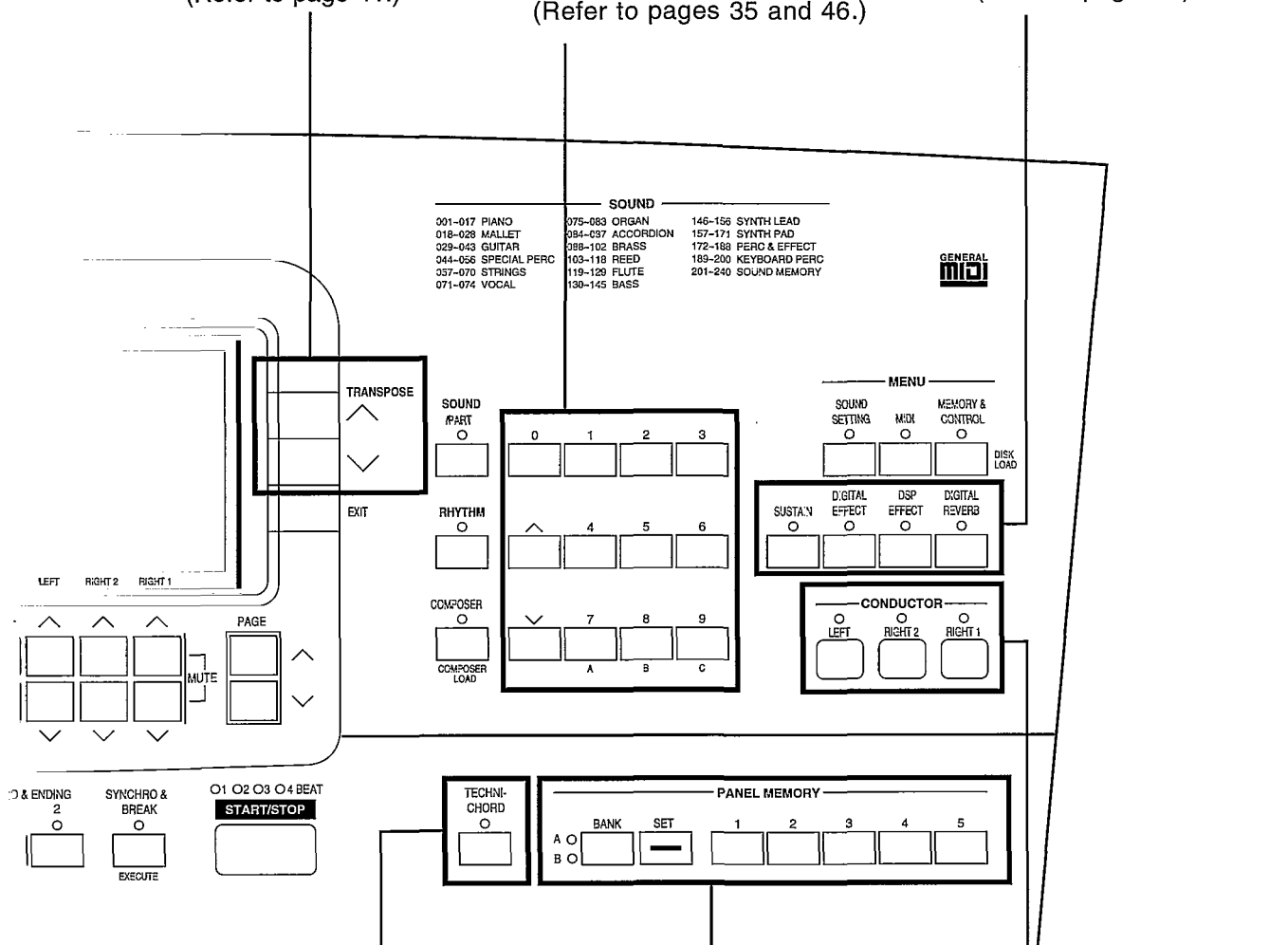

TECHNI-CHORD

Block chords are automatically added to the melody.
(Refer to page 42.)

PANEL MEMORY

Store the panel settings, then recall them instantaneously just by pressing a button or two.
(Refer to page 56.)

CONDUCTOR

Assign a different sound to each part, then assign the desired parts to sections of the keyboard.
(Refer to page 36.)

Backup memory

The various stored memories and function settings are preserved even if the **PLAY** button is turned off, as long as power is being supplied through the AC adaptor or the batteries. If the power supply to this instrument is discontinued (either through the AC adaptor or the batteries), the various memories and settings will be cleared after about 10 minutes.

Controls and functions (KN1500)

SEQUENCER

Record and play back your performance.
(Refer to page 59.)

COMPOSER

Create and store original rhythm patterns.
(Refer to page 77.)

AUTO PLAY CHORD

Add an automatic accompaniment to your selected rhythm.
(Refer to page 49.)

DISPLAY

Displays performance information, function settings and other messages.
(Refer to page 30.)

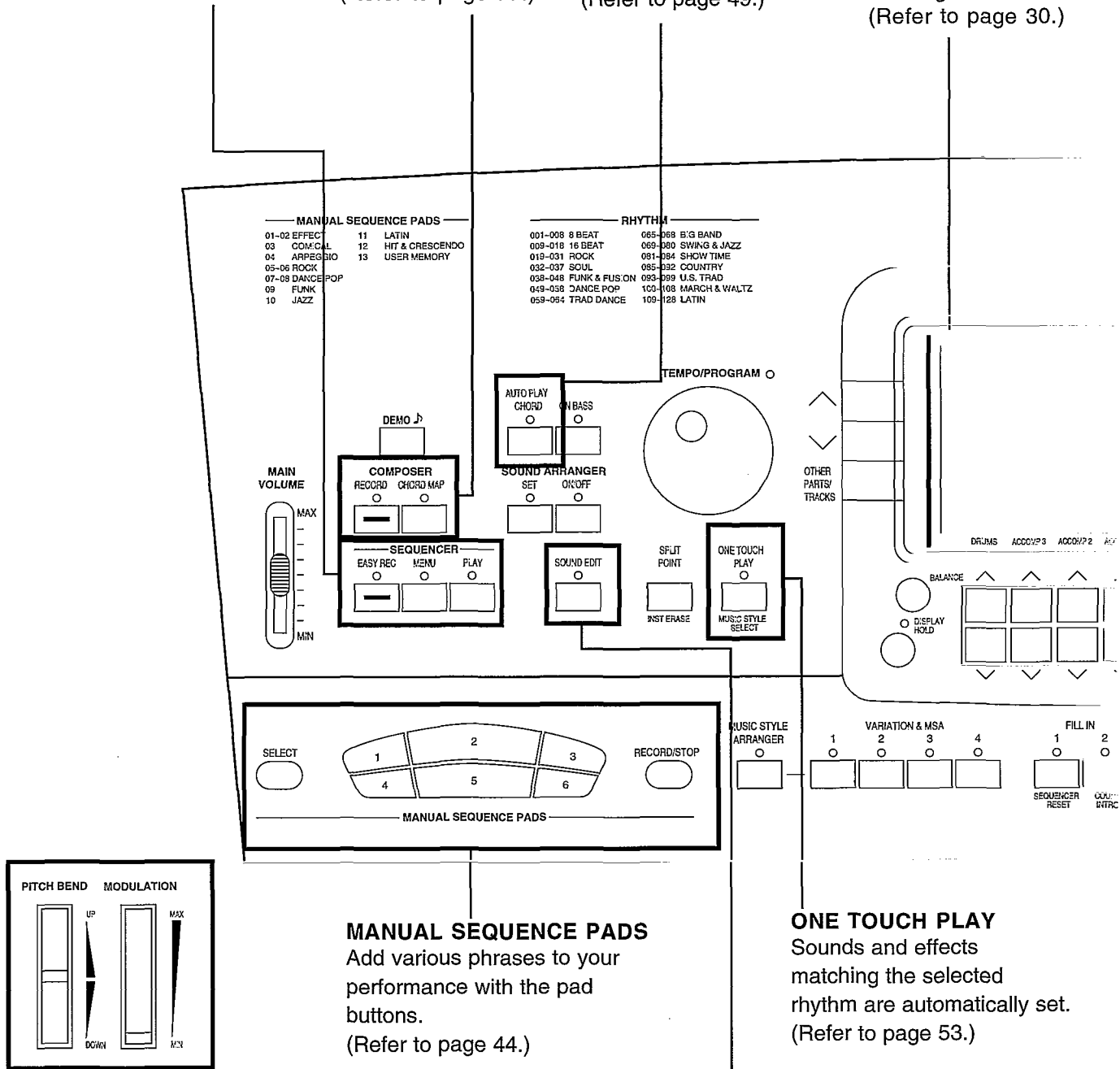

PITCH BEND/MODULATION

The **PITCH BEND** wheel allows a "sliding" change in the pitch. The **MODULATION** wheel is used to add vibrato to the sound.
(Refer to pages 40 and 41.)

MANUAL SEQUENCE PADS

Add various phrases to your performance with the pad buttons.
(Refer to page 44.)

ONE TOUCH PLAY

Sounds and effects matching the selected rhythm are automatically set.
(Refer to page 53.)

SOUND EDIT

Modify preset sounds to create new and unique sounds.
(Refer to page 106.)

TRANPOSE

Raise or lower the key of the entire keyboard.
(Refer to page 41.)

Number pad

Use the number pad to select sounds and rhythms by their numbers.
(Refer to pages 35 and 46.)

Effects

Add various effects to the sounds.
(Refer to page 38.)

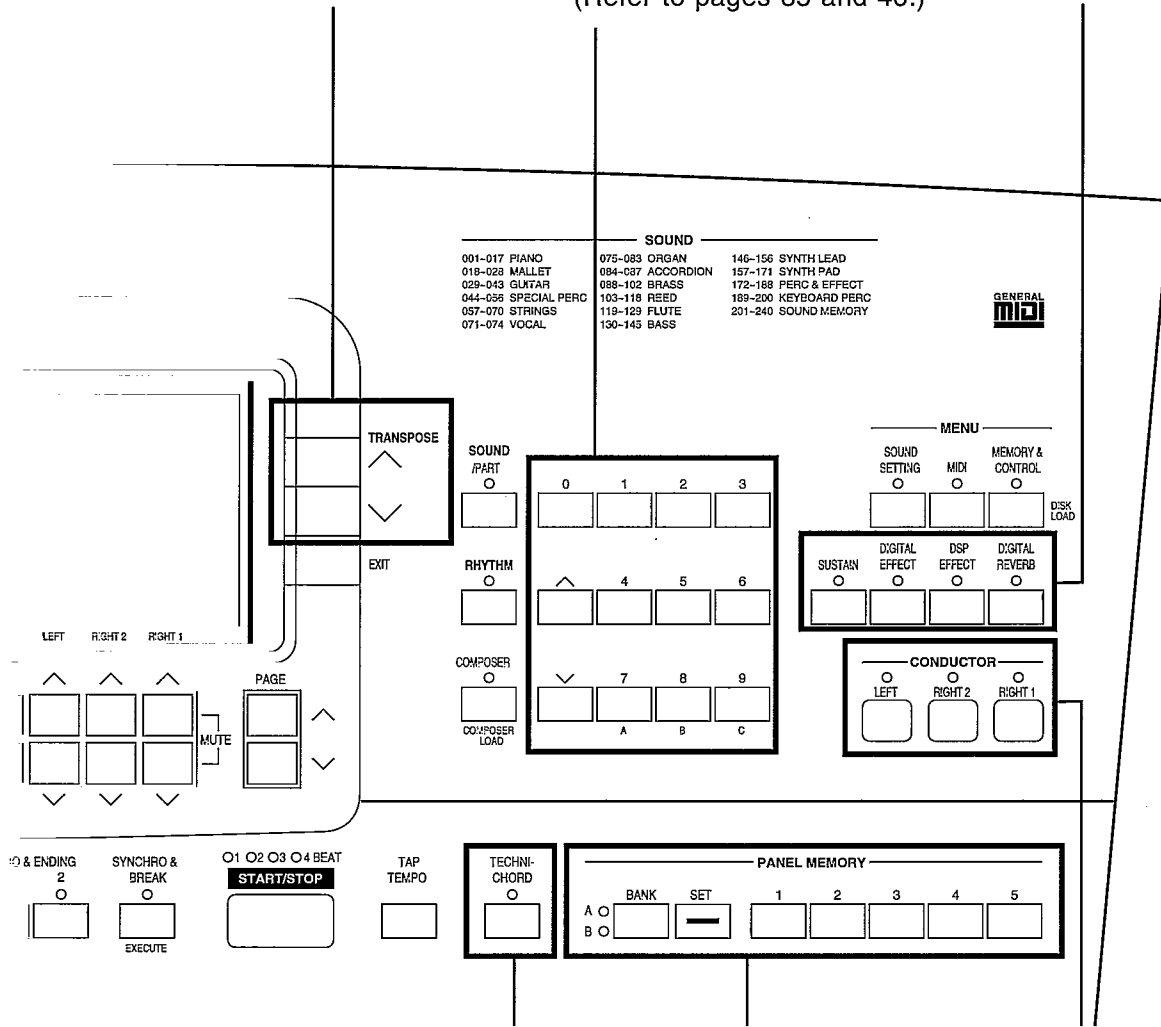

TECHNI-CHORD

Block chords are automatically added to the melody.
(Refer to page 42.)

PANEL MEMORY

Store the panel settings, then recall them instantaneously just by pressing a button or two.
(Refer to page 56.)

CONDUCTOR

Assign a different sound to each part, then assign the desired parts to sections of the keyboard.
(Refer to page 36.)

Getting started (KN720/KN920)

Before you play

This Keyboard can use either dry cell batteries or ordinary household AC current. If using batteries, use six R20/LR20 batteries ("D" size, UM-1). To use AC current, an SY-AD6/AD6B AC adaptor (12V, 2A) is required. (Note: Use of an AC adaptor other than the SY-AD6/AD6B may cause damage to your instrument.)

- The AC adaptor and battery are sold separately.
- The output power differs depending on whether the AC adaptor or batteries are being used.

When using batteries

Open the battery compartment cover, found on the rear of the instrument. Insert six R20/LR20 batteries, and replace the battery compartment cover.

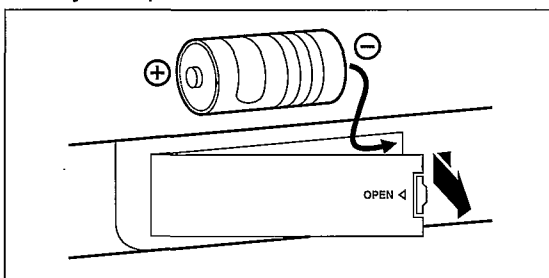

- To insert the batteries correctly, follow the + and - polarity indications. (Batteries installed with incorrect polarities may leak and damage this unit. If the leaking electrolyte comes into contact with skin or clothes, flush with water immediately.)
- Do not mix batteries (old and new) or types (carbon and alkaline).
- Remove the batteries from the battery compartment and store separately when the instrument is not to be used for a long time.
- Never subject batteries to excessive heat or flame; do not attempt to disassemble them; and be sure they are not short-circuited.
- Do not attempt to recharge carbon or alkaline batteries.

When using the AC adaptor

Connect the AC adaptor.

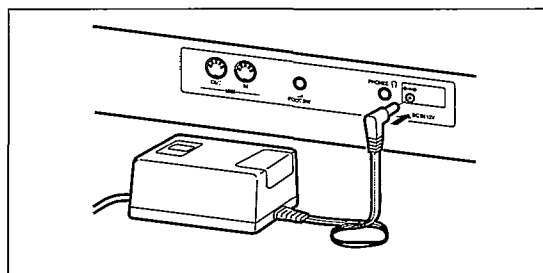

- Do not disconnect and connect the AC adaptor when the **PLAY** button is on.

Music stand

Affix the music stand as shown.

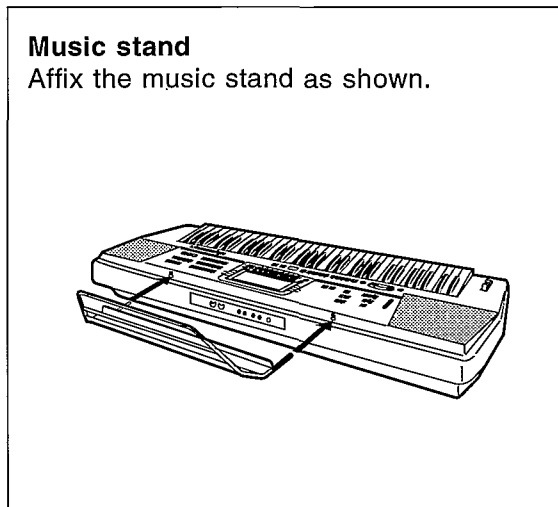

- Even when batteries are installed, if the AC adaptor is used, the battery circuit is bypassed and the power is supplied through the AC adaptor.
- When batteries are used, if the instrument is left on but the controls are not touched for a while (about 5 minutes), the energy-saving function is activated and the **PLAY** button turns off automatically.
- When the power is withdrawn from this instrument, the various storable memories and storable function settings of this instrument will be erased in about 10 minutes.
- When battery power is low during a performance, "WARNING! LOW BATTERIES!" is shown on the display. In this case, replace the batteries as soon as possible.

Playing

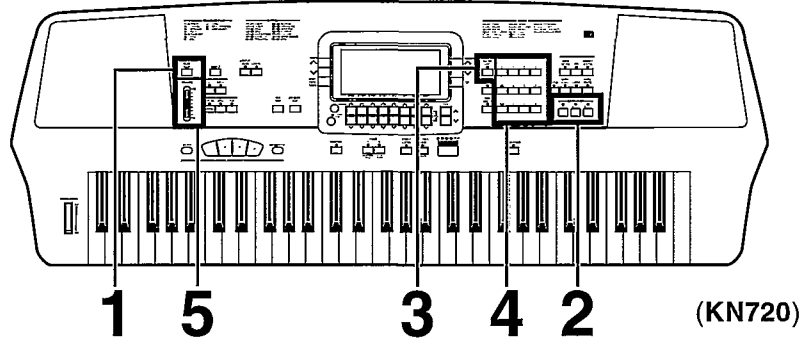

1 Press the **PLAY** button to turn it on.

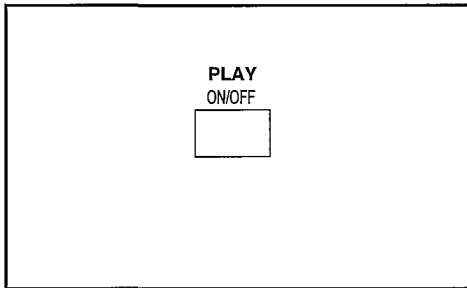

4 On the number pad, press **0, 0, 2**.

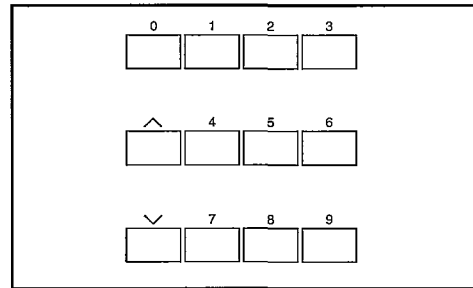

- Touch any note on the keyboard. You will hear the “Bright Piano” sound.

2 In the **CONDUCTOR** section on the panel, press the **RIGHT 1** button to turn it on.

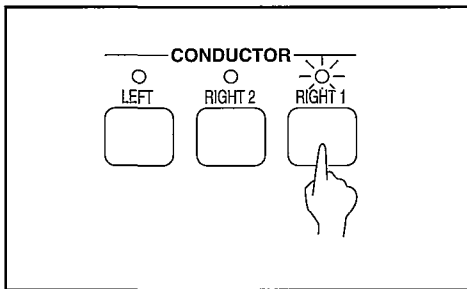

5 Set the **MAIN VOLUME** to an appropriate level with the sliding control.

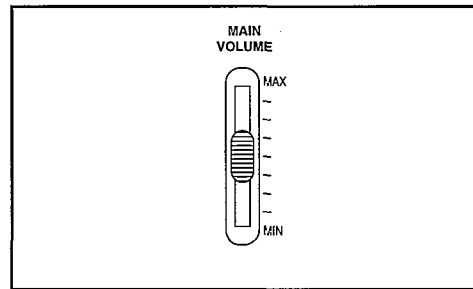

- Your Keyboard features Touch Response. You control the volume by playing the keys harder or softer.

3 Use the **SOUND/PART** button to select **RIGHT 1**.

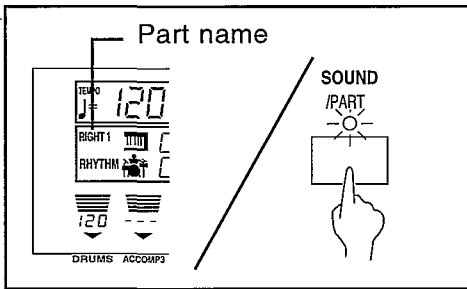

- The pitch of this instrument can be adjusted for when playing with other instruments. (Refer to page 103.)



Getting started (KN1500)

Before you play

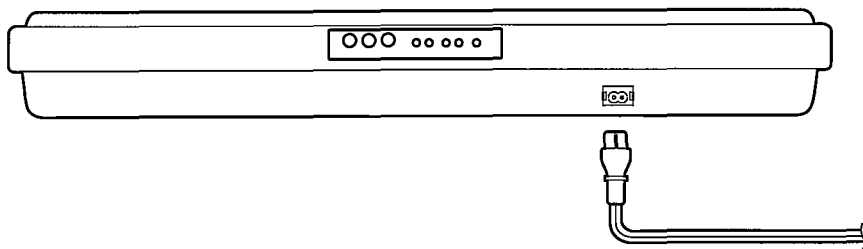

- 1 | Plug the power cord into an outlet.

- 2 | Affix the music stand as shown.

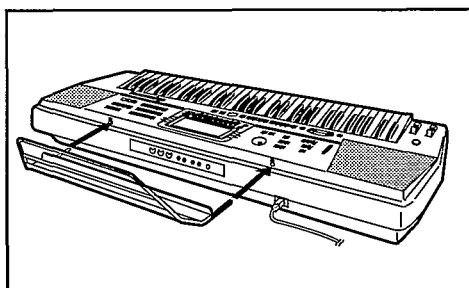

About the backup memory

The panel settings and stored memories are maintained in a backup memory for about 10 minutes after the power to this instrument is turned off. If you wish to keep the memory contents, before you turn off the instrument, use the SAVE procedure to store the desired data on a disk for recall at a later time.

- The backup memory does not function until the power has been on for about 10 minutes.
- When you quit the operating mode, a warning display may appear to remind you to save the data.

-
- The pitch of this instrument can be adjusted for when playing with other instruments. (Refer to page 103.)

Playing

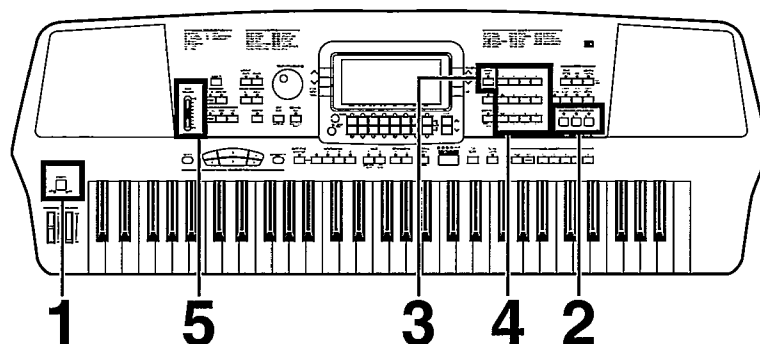

- 1** Press the **POWER** button to turn it on.

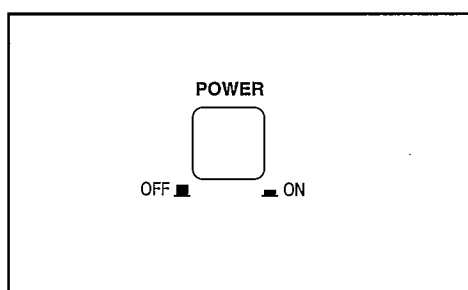

- Under certain conditions, the functions and memories of this instrument may be initialized when the power is turned on.

- 2** In the **CONDUCTOR** section on the panel, press the **RIGHT 1** button to turn it on.

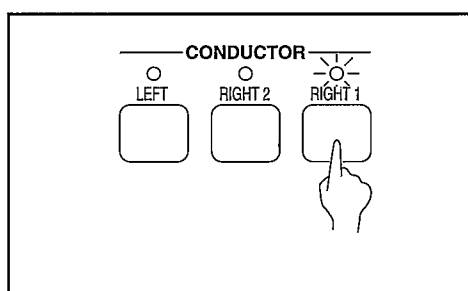

- 3** Use the **SOUND/PART** button to select RIGHT 1.

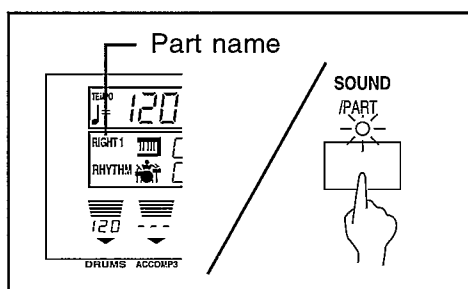

- 4** On the number pad, press **0, 0, 8**.

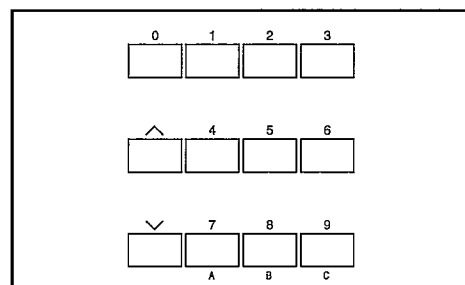

- Touch any note on the keyboard. You will hear the "Midi Grand" sound.

- 5** Set the **MAIN VOLUME** to an appropriate level with the sliding control.

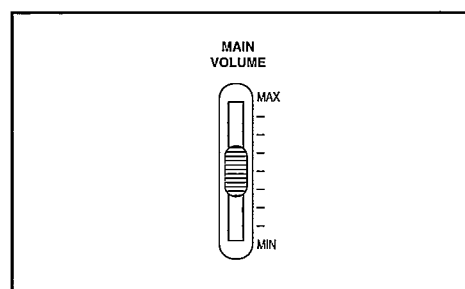

- Your Keyboard features Touch Response. You control the volume by playing the keys harder or softer.

Listen to the demonstration

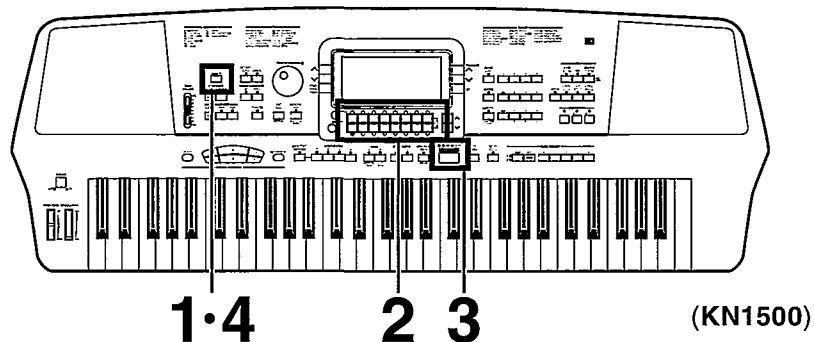

1 Press the **DEMO** button.

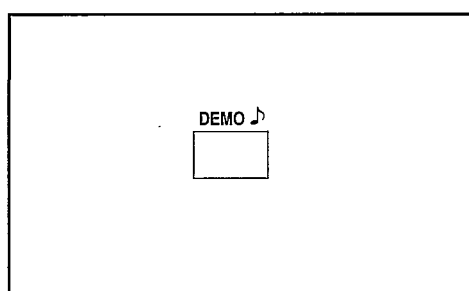

- The display changes to the DEMO SONG display.

2 Use the **LEFT** ^ and v buttons to select a song number.

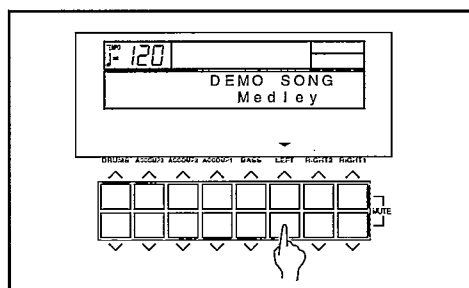

- If you select "Medley," all the songs are played in a medley performance.

3 Press the **START/STOP** button.

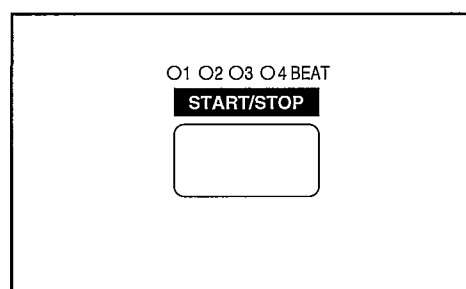

- The demonstration performance corresponding to your selection begins.
- To end the demonstration before it has finished, again press the **START/STOP** button.
- To listen to other songs, repeat steps 2 and 3.
- If "Medley" was selected, all the songs are played in order in a medley performance. The medley performance continues until the **START/STOP** button or the **DEMO** button is pressed again.

4 When you are finished listening to the demonstration tunes, press the **DEMO** button again.

- If you press and hold the **DEMO** button for a few seconds, or if you press first the **DEMO** button and then the **START/STOP** button, you can also begin a medley performance.

- During the medley performance, use the **LEFT** ^ and v buttons if you wish to change to a different song.
- Some of the buttons do not function while the demonstration performances are being played.

Selecting sounds

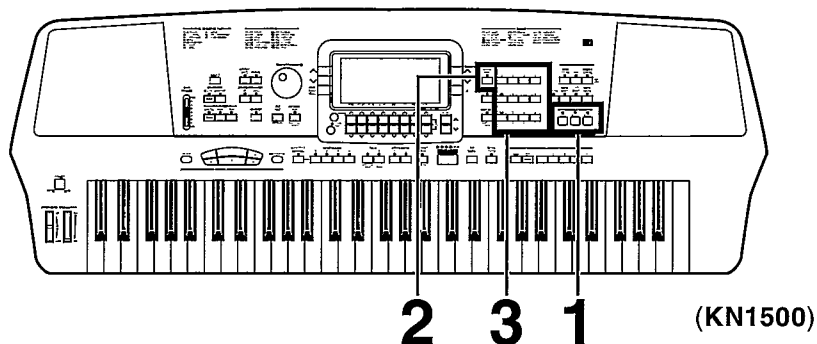

1 In the **CONDUCTOR** section, turn on the **RIGHT 1** button.

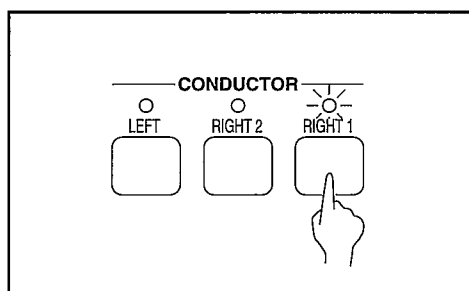

2 Use the **SOUND/PART** button to select **RIGHT 1**.

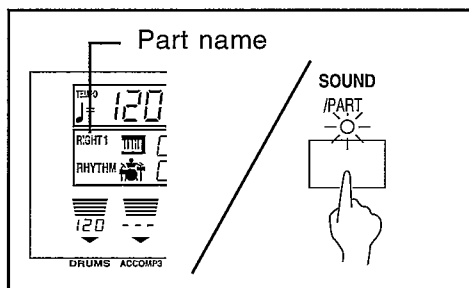

3 On the number pad, select a sound number (3 digits).

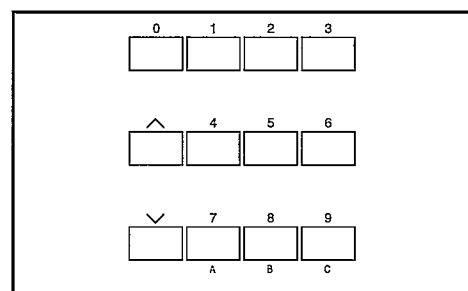

- The number and name of the sound you selected is shown on the display.
- The list of sound groups and their numbers is found on the upper part of the operation panel.
- For single-digit sound numbers: for sound **003**, for example, press **0, 0, 3**.
- You can use the **^** and **v** buttons to change to the next higher or lower sound number.

- Other things you can do are mixing sounds and playing different sounds on the left and right areas of the keyboard. (Refer to page 36.)

Add effects

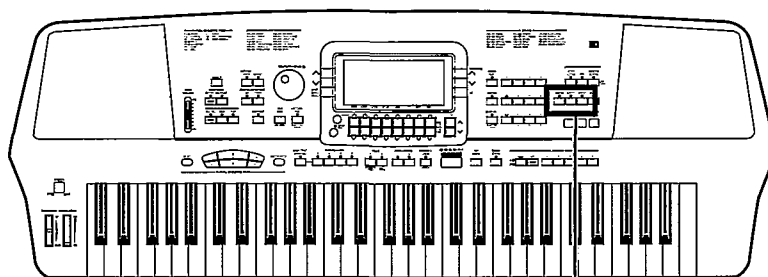

A·B·C

(KN1500)

Add a feeling of spaciousness to the sound.

A Turn on the **DIGITAL EFFECT** button.

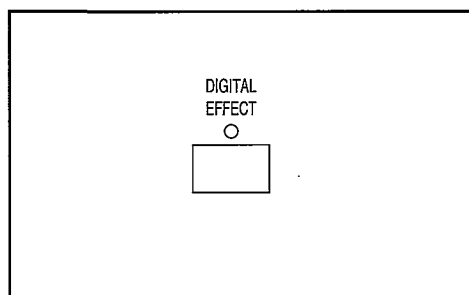

- The sound is broader and deeper.

Add breadth to the sound. (KN720)

C Turn on the **CHORUS** button.

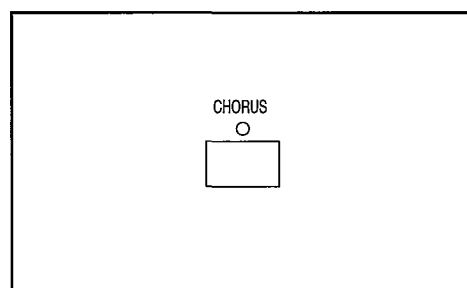

Add sustain.

B Turn on the **SUSTAIN** button.

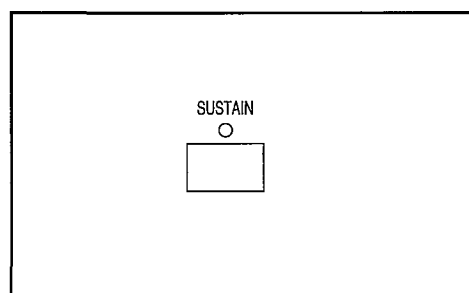

- Play and release a key. The tones fade out gradually after the key is released.

Add a unique quality to the sound. (KN920/KN1500)

C Turn on the **DSP EFFECT** button.

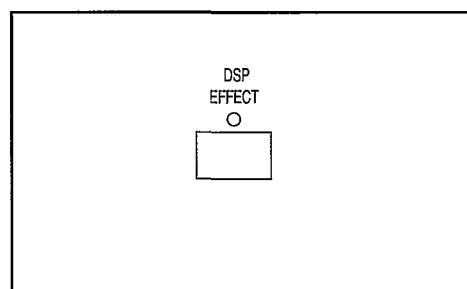

- The type of **DIGITAL EFFECT** differs depending on the selected sound.

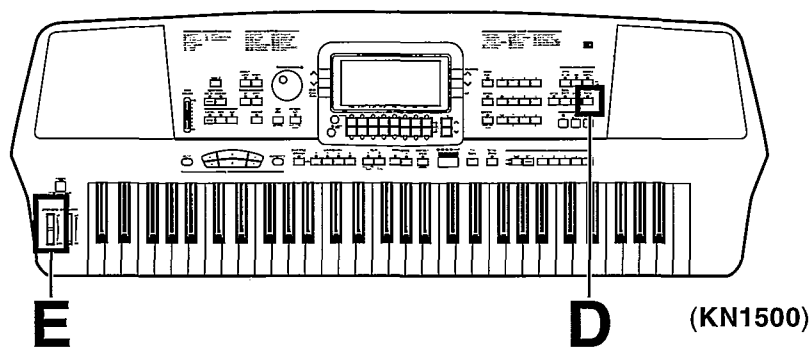

Add reverb.

D Turn on the **DIGITAL REVERB** button.

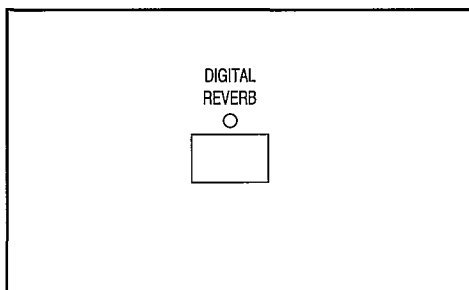

- The reverb effect is applied to all sounds.

Change the pitch.

E While playing a key on the keyboard, move the **PITCH BEND** wheel up and down.

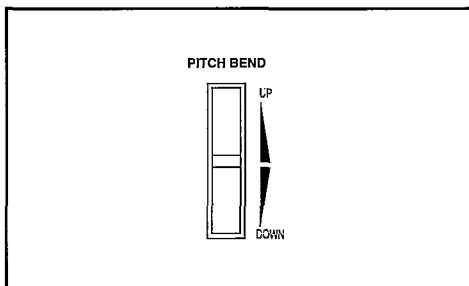

- The pitch of the played key slides up and down, as when you bend the strings on a guitar.



Playing automatic rhythms (KN720)

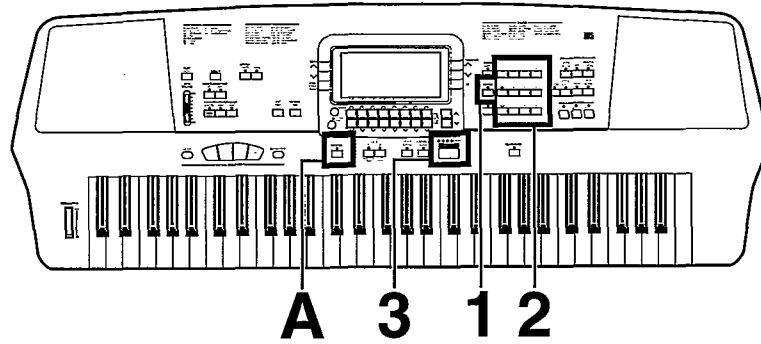

1 Press the **RHYTHM** button to turn it on.

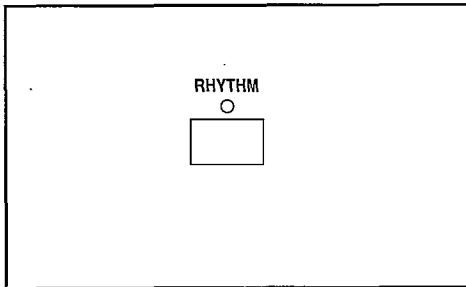

2 On the number pad, select a rhythm number (3 digits).

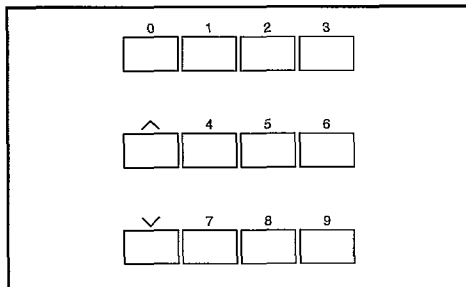

- The list of rhythm groups and their numbers is shown at the upper left of the operation panel.
- You can use the \wedge and \vee buttons to change to the next higher or lower rhythm number.

3 Start the rhythm by pressing the **START/STOP** button.



- Stop the rhythm by pressing the **START/STOP** button again.

Select a variation.

A When you turn on the **VARIATION** button, the nuance of the pattern changes.

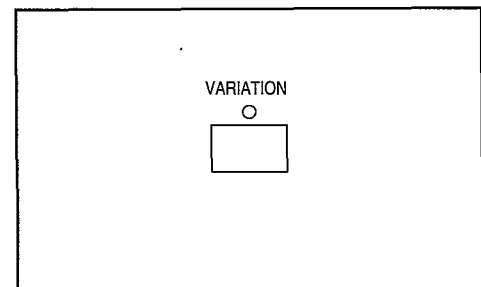

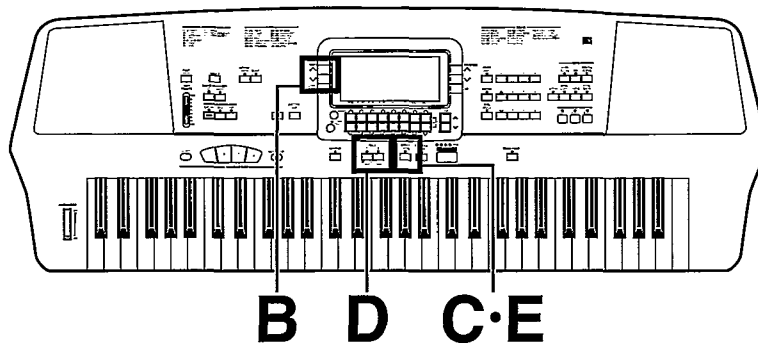

Adjust the tempo.

B Adjust the tempo with the **TEMPO** buttons.

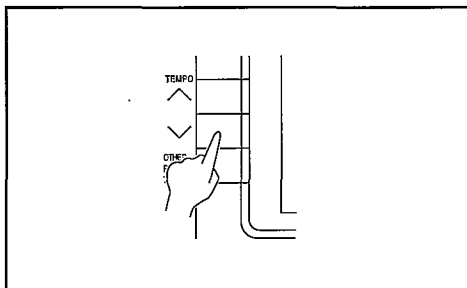

- The tempo is shown on the display as “♪ =”.

Insert a fill-in pattern.

D While the preset rhythm pattern is playing, press either the **FILL IN 1** or **2** button.

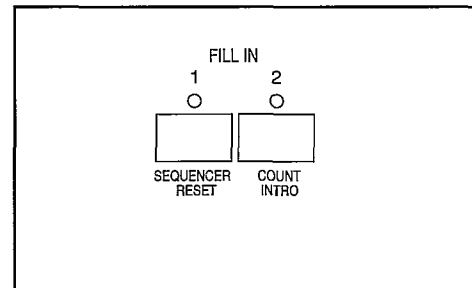

- A fill-in pattern immediately starts to play.

Insert an intro pattern.

C To start your performance with an introduction, press the **INTRO & ENDING** button before starting the rhythm.

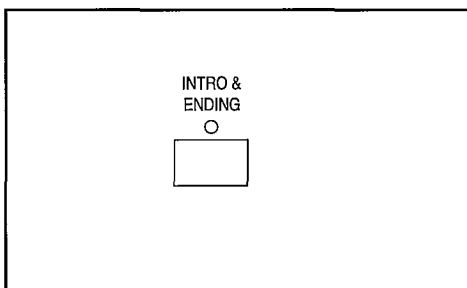

- An intro is played, after which the regular rhythm starts.

Insert an ending pattern.

E While the rhythm is playing, press the **INTRO & ENDING** button.

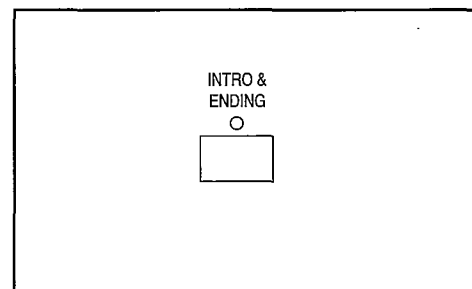

- You will hear an ending pattern, and then the rhythm stops.



Playing automatic rhythms (KN920/KN1500)

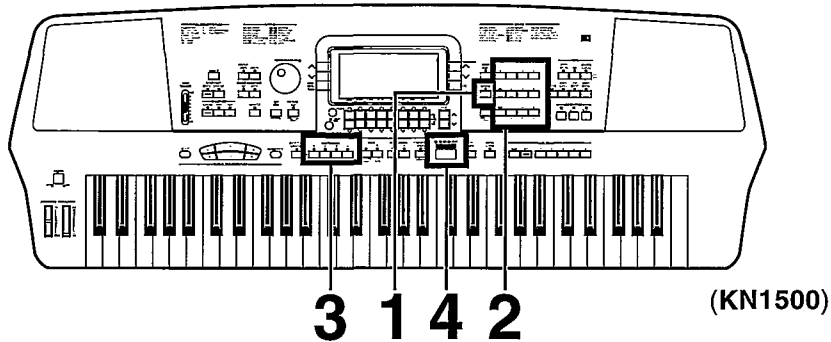

1 Press the **RHYTHM** button to turn it on.

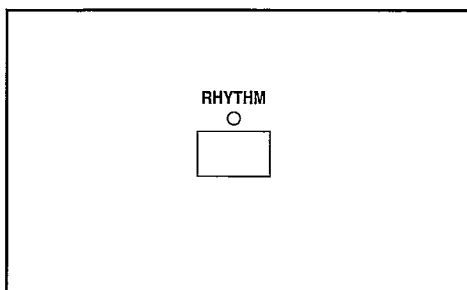

3 Use the **VARIATION** buttons to select the variation number.

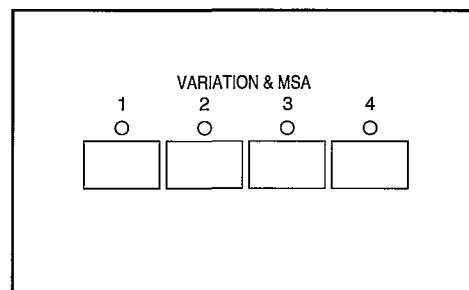

2 On the number pad, select a rhythm number (3 digits).

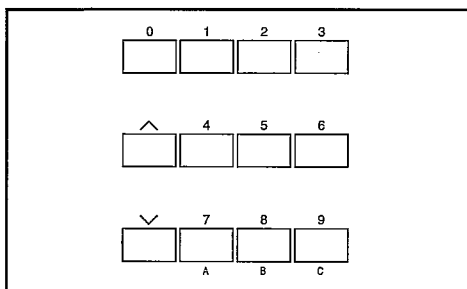

- The list of rhythm groups and their numbers is shown at the upper left of the operation panel.
- You can use the \wedge and \vee buttons to change to the next higher or lower rhythm number.

4 Start the rhythm by pressing the **START/STOP** button.

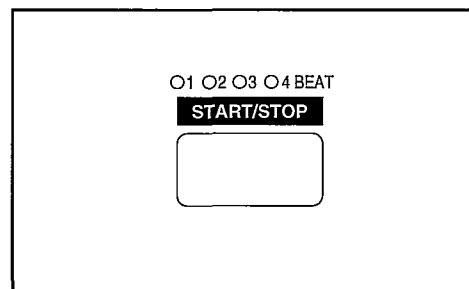

- Stop the rhythm by pressing the **START/STOP** button again.

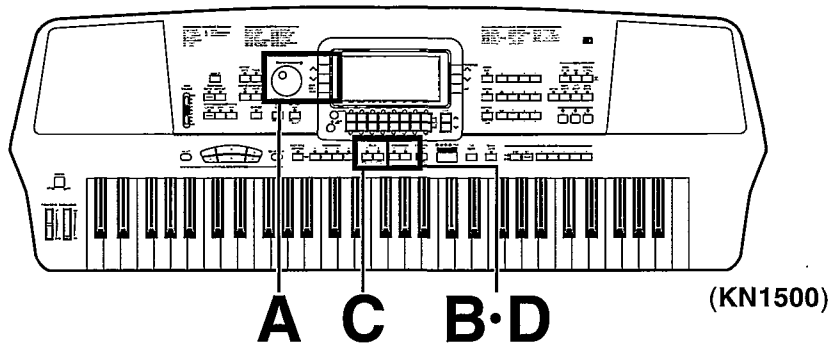

Adjust the tempo.

A Adjust the tempo with the **TEMPO** buttons.

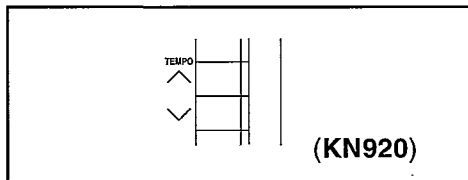

KN1500: You can also adjust the tempo with the **TEMPO/PROGRAM** dial.

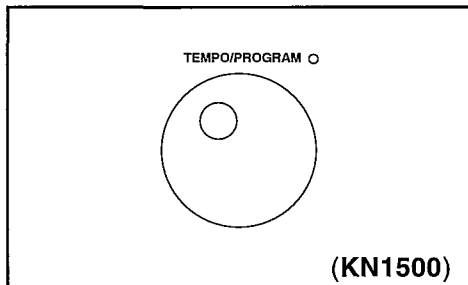

- The tempo is shown in the display as “♩ = ”.

Insert an intro pattern.

B To start your performance with an introduction, press the **INTRO & ENDING 1** or **2** button before starting the rhythm.

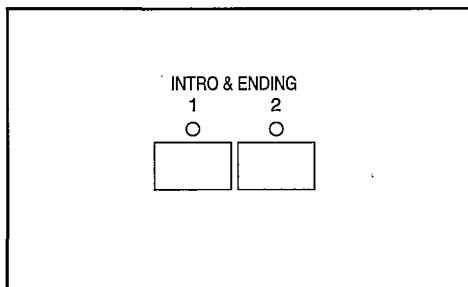

- An intro is played, after which the regular rhythm starts.

Insert a fill-in pattern.

C While the preset rhythm pattern is playing, press either the **FILL IN 1** or **2** button.

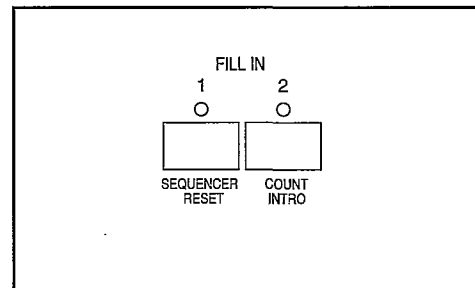

- A fill-in pattern immediately starts to play.

Insert an ending pattern.

D While the rhythm is playing, press the **INTRO & ENDING 1** or **2** button.

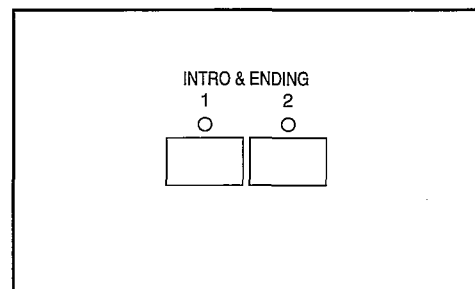

- You will hear an ending pattern, and then the rhythm stops.

Automatic accompaniment

Just by specifying a chord on the keyboard, an accompaniment pattern which matches the selected rhythm is automatically played.

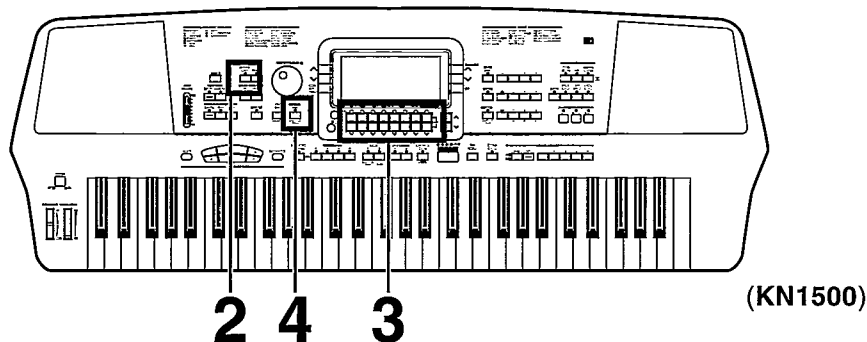

Use the **AUTO PLAY CHORD** with the following tune.



1 Select a rhythm (other than a three-beat rhythm).

2 Turn on the **AUTO PLAY CHORD** button.

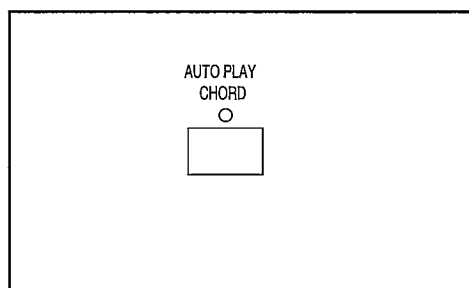

3 Use the **BASS** \wedge and \vee buttons to select "1 Finger."

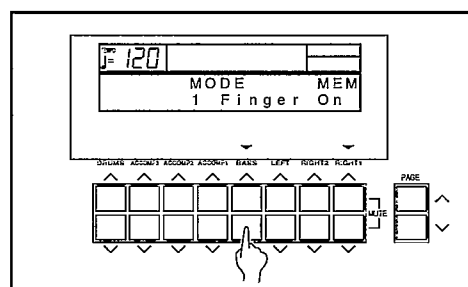

- The display returns to the previous display after a few seconds.

4 Press and hold the **ONE TOUCH PLAY** button for a few seconds until the panel settings change.

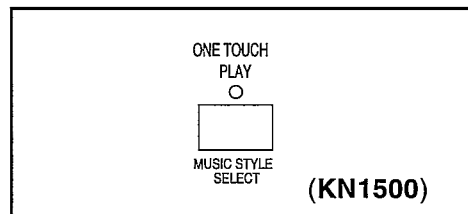

- The panel settings automatically change to those matching the rhythm you selected in step 1.

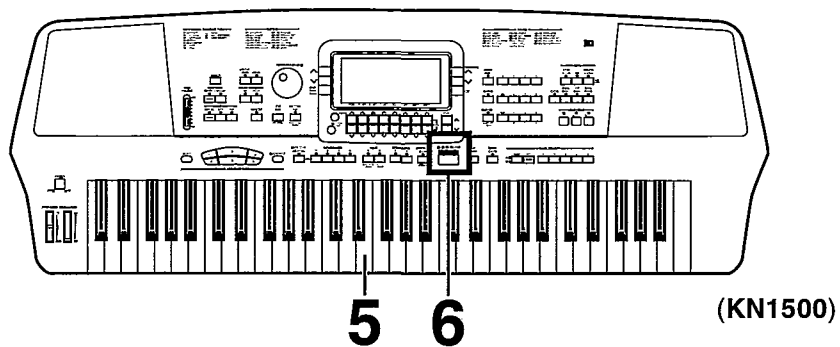

5 Use your left hand to play the chords and your right hand to play the melody.

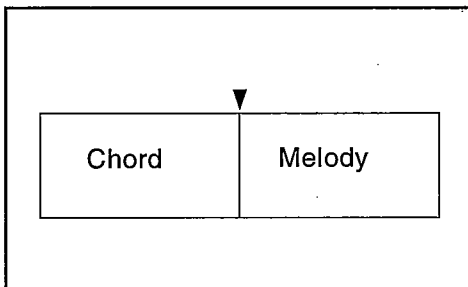

- Pressing a key on the left area of the keyboard will cause the automatic rhythm pattern to start playing (synchro start).
- When the C key is pressed on the left area of the keyboard, an accompaniment begins to play in the C major key.
- Playing the chord key (root note) and the white key to its left will produce a 7th chord.

6 At the end of your performance, press the **START/STOP** button.

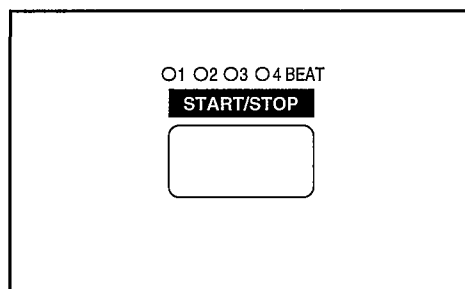

- The automatic accompaniment stops.
- When ending a performance which uses the automatic accompaniment, press the **AUTO PLAY CHORD** button to turn it off.

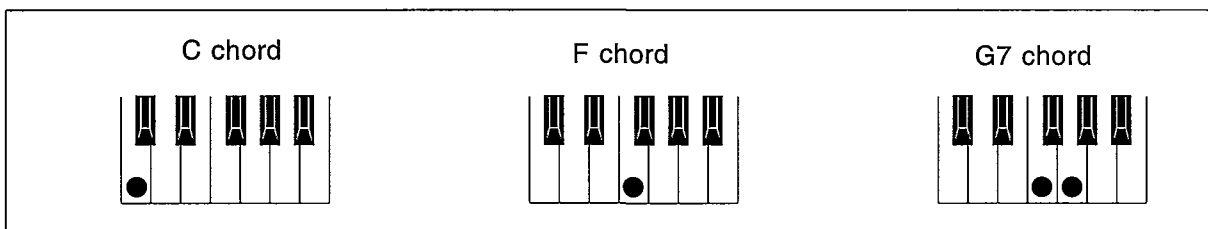

- **KN1500:** You can also have the panel settings change to automatically match the style you select. (Refer to page 54.)



Record your performance

Use the **SEQUENCER** to record your performance.

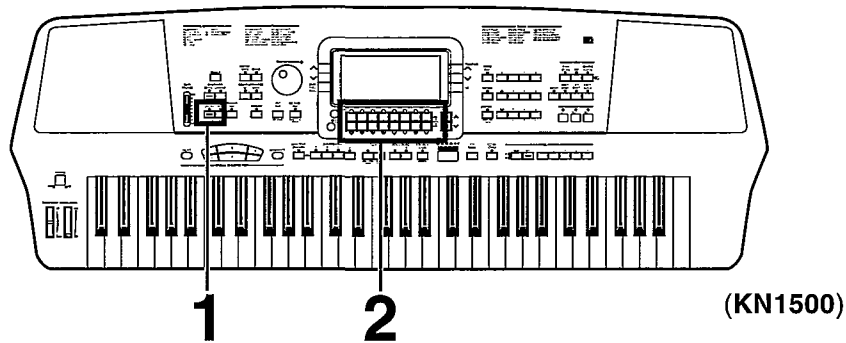

Sonatina

Sound: **001** [Grand Piano] (**RIGHT 1** part)

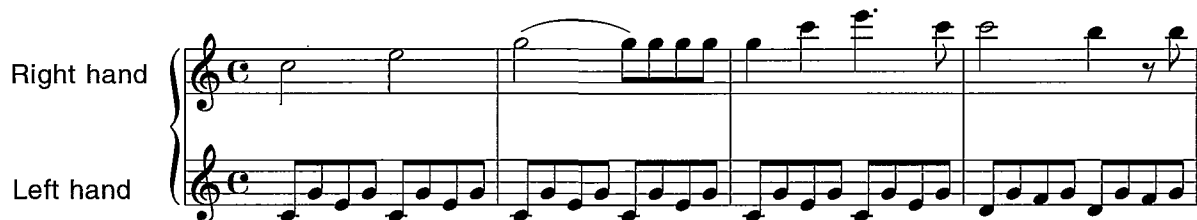

1 Press the **EASY REC** button to turn it on.

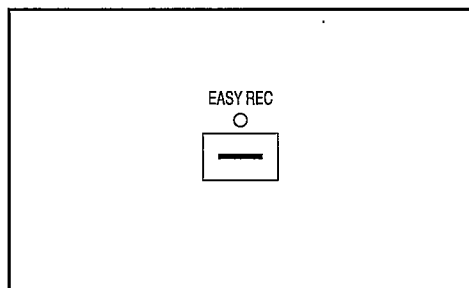

- The display changes to the EASY RECORD display.

2 Press either **LEFT** (Yes) button.

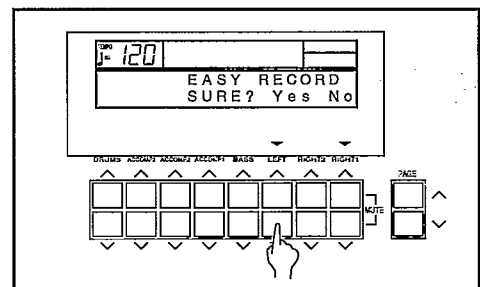

- The display changes to the REC display.

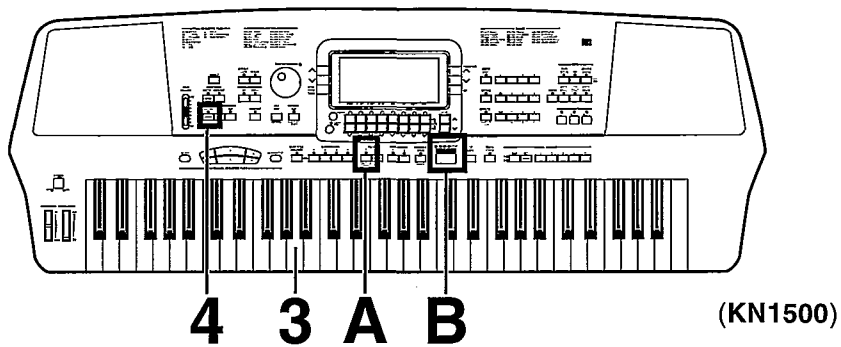

3 | Play the song on the keyboard.

4 | When you have finished playing, press the **EASY REC** button again to turn it off.

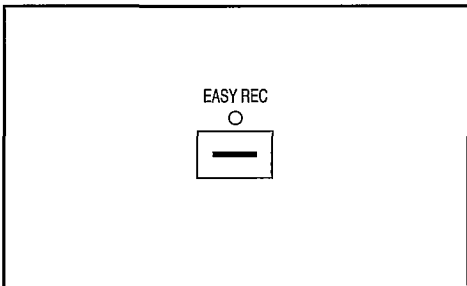

- The display changes to the SEQ PLAY display.

Playing back your recorded performance

A | Press the **SEQUENCER RESET (FILL IN 1)** button.

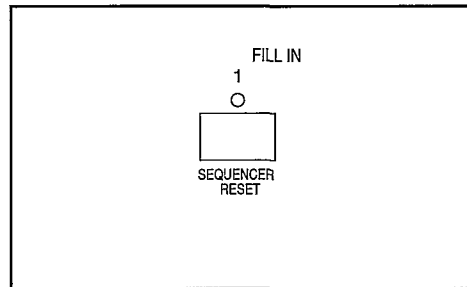

B | Press the **START/STOP** button.

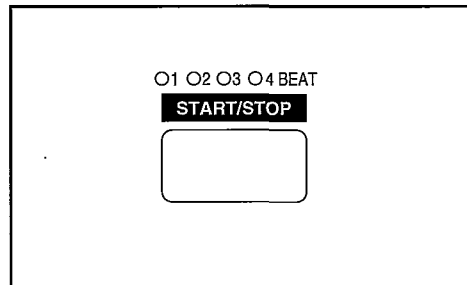

- Your performance is played back just as you recorded it.
- When you are finished playing back your performance, press the **PLAY** button in the **SEQUENCER** section to turn it off.

- You can also record several parts individually and then have them played back together for an ensemble performance. (Refer to page 64.)

Playing commercial disks (KN920/KN1500)

You can play commercial song disks such as Standard MIDI File (SMF) FORMAT 0 or DISK ORCHESTRA COLLECTION™ (DOC) disks on this instrument.

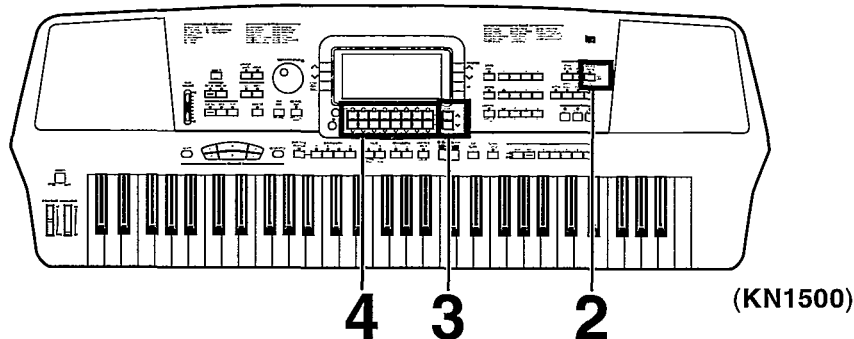

- 1** Insert the song disk into the Disk Drive slot. Push it all the way in until you hear a click.

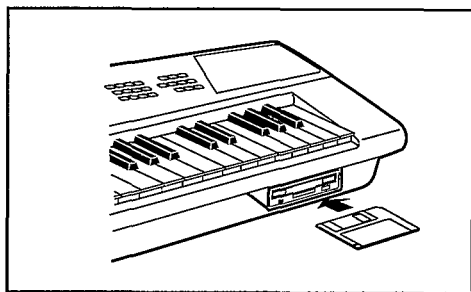

- 3** Press the **PAGE** ^ button to select "P2 Direct Play."

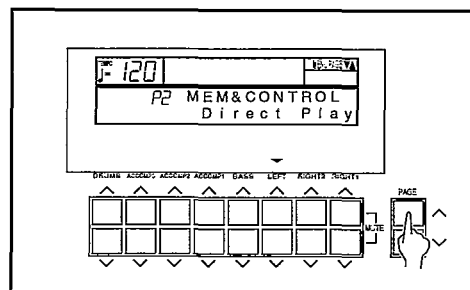

- 2** Press the **MEMORY & CONTROL** button to turn it on.

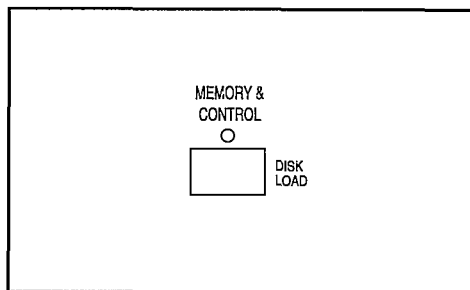

- The display changes to the MEM & CONTROL display.

- 4** Press the **LEFT** ^ or v button.

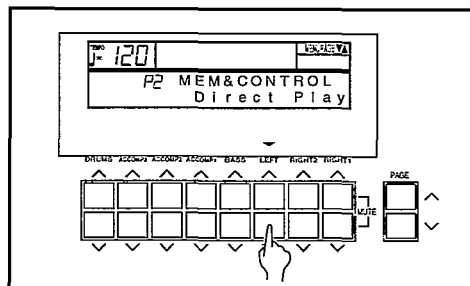

- The display changes to the DIRECT PLAY display.

About the display

The display shows various information and is used for most of this instrument's operations.

Normal display

This illustration shows the kind of information you see on the display during a normal performance.

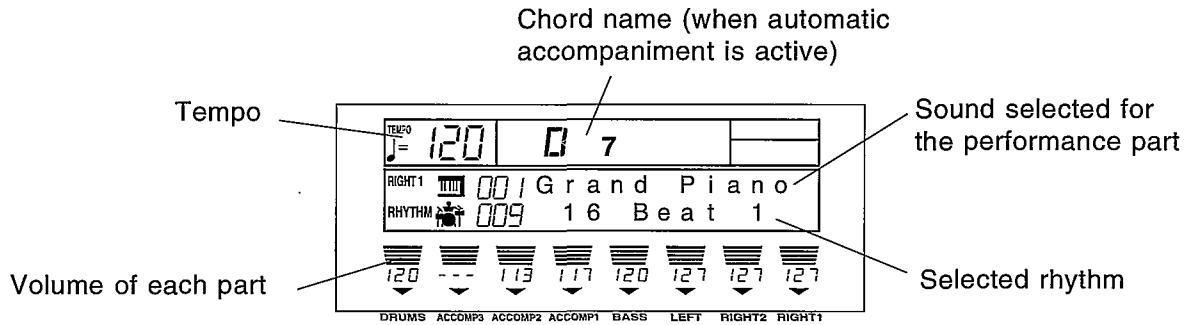

Volume balance

At the bottom half of the normal display, the volume balance of each part is shown as a bar graph and a number (0 to 127).

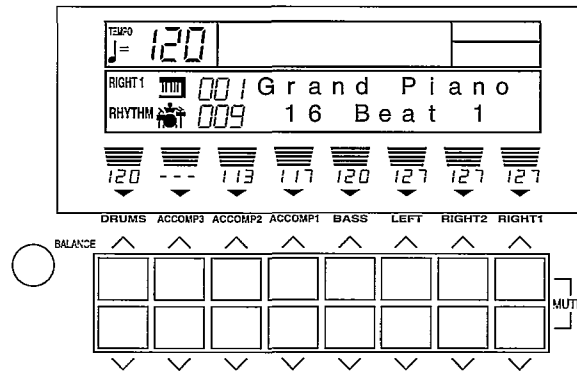

Use the ^ and v buttons directly below the display to adjust the volume of each part.

- If you press and hold a button, the scrolling speed becomes fast.
- Even when the display is not the normal display, you can view the volume balance by pressing the **BALANCE** button, located to the lower left of the display.

■ MUTE

To mute a part, press both the corresponding ^ and v buttons at the same time.

- The number indication for the volume of a muted part is shown as [---].
- Pressing either balance button for a muted part will cancel the mute function.

■ OTHER PARTS

Press the **OTHER PARTS/TRACKS** button to show the **PART BALANCE** display for MSP (**MANUAL SEQUENCE PADS**), [Part 1 – 8]; press again for [Part 9 – 16].

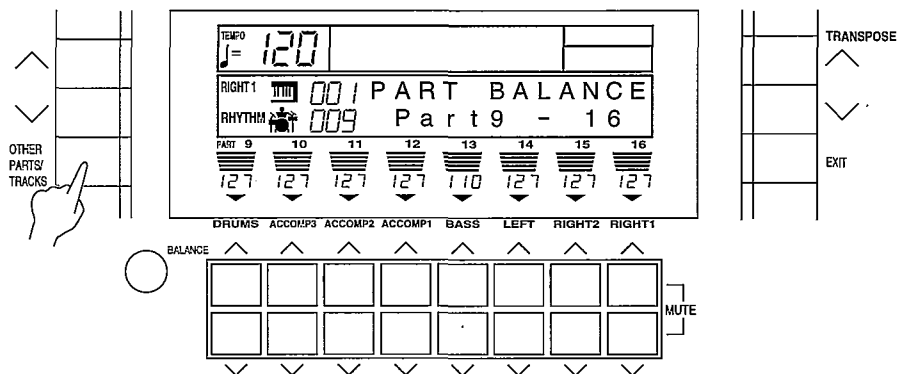

- Press the **EXIT** button to return to the display before the volume setting display.
- These parts are used when this instrument is being utilized as a 16-part multi-timbre sound generator: during **SEQUENCER** operation, during song disk playback (**KN920/KN1500**) or when external MIDI equipment is connected.

PAGE buttons

When the current display fills more than one screen, a **PAGE** indication is shown on the display. For example, if **PAGE ▲** is shown on the display, it means that there is a following page or pages. Likewise, **PAGE ▼** indicates a previous page, and **PAGE ▼▲** indicates a previous and a following page. In this case, you can use the **PAGE** **▲** and **▼** buttons to the right of the balance buttons to view different “pages” of the display.

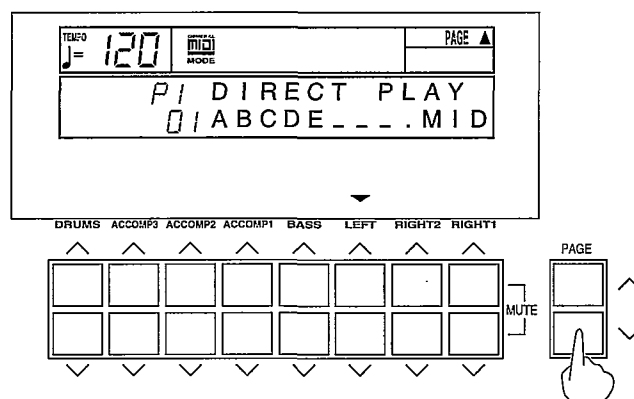

- Press the **▲** button to view the next page of the display, and the **▼** button to view the previous page of the display.
- P1, P2 etc. on the display indicates the page number.

MENU displays

The buttons shown in the illustration below for example control multiple functions. Pressing one of the buttons will access the corresponding MENU display.

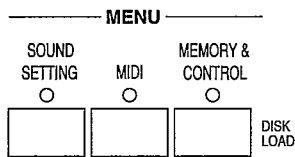

■ Example of MENU display: MEMORY & CONTROL

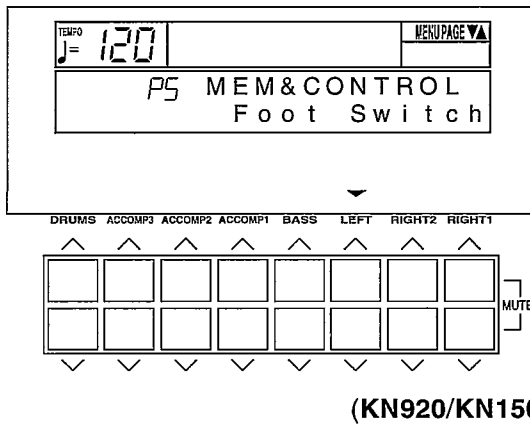

The **PAGE** buttons are also used to select the menu pages. When selecting a menu, a MENU PAGE indication is shown in the upper right part of the screen. For example, to select [Foot Switch], use the **PAGE** \wedge button to select page 5 (P5) (KN920/KN1500).

- In this manual, this procedure is written as follows: "Select [P5 Foot Switch]."
- To access the setting display, press the button below the display which corresponds to the \blacktriangledown indication (in this example, either **LEFT** \wedge or \vee button).

Setting display

When necessary, the buttons below the display are used to set the functions.

■ Example of setting display: Foot Switch

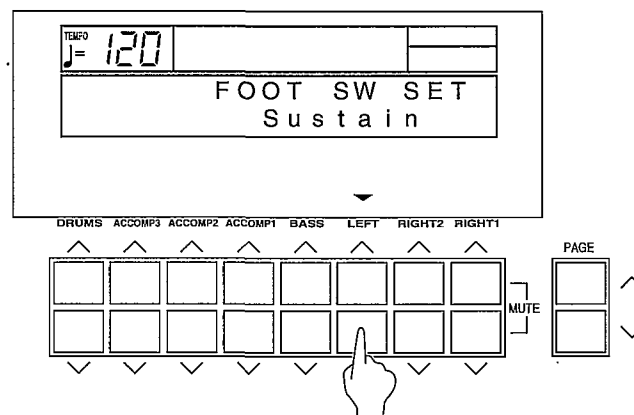

One or more \blacktriangledown indications at the bottom of the screen indicate that the corresponding balance buttons below the display are used to change the settings. In this example, the **LEFT** \wedge and \vee buttons are used.

- In this manual, this procedure is written as follows: "Use the **LEFT** \wedge and \vee buttons to select the function."

EXIT button

While the setting display is shown, press this button to go back to the previous display.

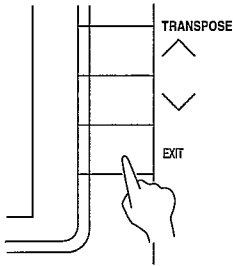

DISPLAY HOLD button

Press this button to turn it on when you wish to maintain the current display. For example, you can maintain a setting display which normally turns off automatically, or even during a performance you can monitor information which is not shown on the normal performance display.

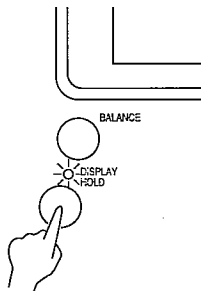

- If you are viewing a setting display which normally turns off automatically, this indicator may flash.
- If any of the **MENU** buttons, for example, is pressed, the **DISPLAY HOLD** mode is canceled.



CONTRAST

Adjust the contrast of the display.

1. Press the **MEMORY & CONTROL** button to turn it on.

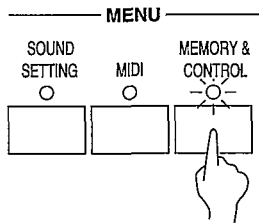

- The display looks similar to the following.

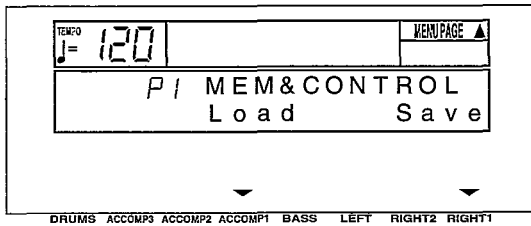

2. Use the **PAGE** buttons to select [P4 Contrast] (KN720) or [P6 Contrast] (KN920/KN1500).

- The display looks similar to the following.

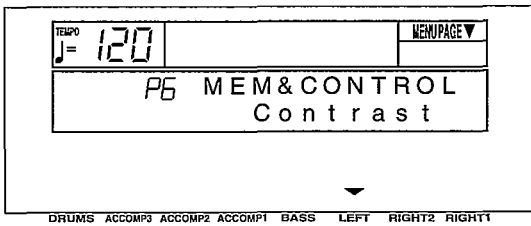

(KN920/KN1500)

3. Press either **LEFT** button.

- The display looks similar to the following.

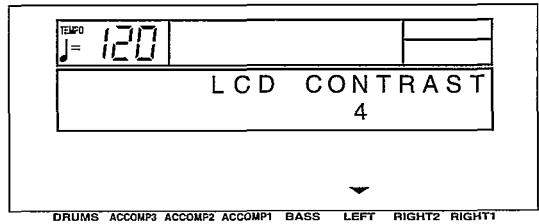

4. Use the **LEFT** ^ and v buttons to adjust the setting (1 to 8).

- Adjust the contrast of the display so that it is easy to read.

5. When you have completed making the settings, press the **MEMORY & CONTROL** button to turn it off.

TEMPO/PROGRAM dial (KN1500)

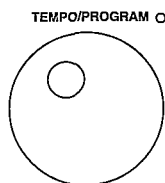

If the **TEMPO/PROGRAM** indicator is lit while you are using the display to adjust a setting, it indicates that the dial may be used to change the displayed value or setting.

Part I Sounds and effects

Selecting sounds

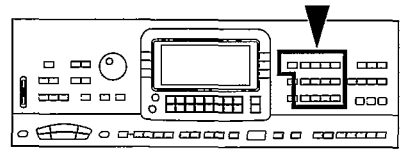

Select the sounds for the three parts you can play on the keyboard—**RIGHT 1**, **RIGHT 2** and **LEFT**.

1. Use the **SOUND/PART** button to select a part (**RIGHT 1**, **RIGHT 2** or **LEFT**).

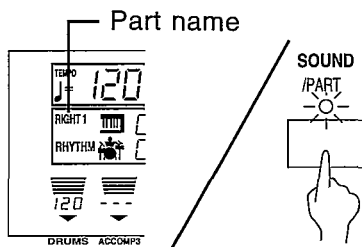

- The selected part is shown on the display.

2. On the number pad (**0** to **9**), press the buttons to select the desired sound (3 digits).

- The list of sound group names and their corresponding numbers is found on the upper part of the operation panel.
- A list of all the sounds and their numbers can be found in the separate **REFERENCE GUIDE** provided.

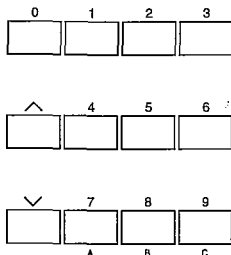

- Enter three digits to select the sound. For example, to select sound **003**, press **0**, **0**, **3**. To select sound **030**, press **0**, **3**, **0**.
- Do not enter the digits too slowly. If you wait too long after entering a number before entering the next number, the first number will be canceled.
- The selected sound is assigned to the part you selected in step 1.
- While the setting is being changed, the name of the selected part, and the number and name of the selected sound are shown on the display.

▲ and ▼ buttons



- Keep the ▲ or ▼ button pressed to scroll the numbers quickly.

■ Percussion sounds

The sounds in the **KEYBOARD PERC** group are percussion instrument sounds.

- Percussion instrument sounds are produced by the keyboard keys as indicated by the picture code above each key.
- For further information about the arrangement of percussion sounds, refer to the separate **REFERENCE GUIDE** provided.



3. Repeat steps 1 and 2 to select sounds for the other parts.

- The **CONDUCTOR** buttons are used to assign parts to the keyboard. (Refer to page 36.)
- Most of the sounds in the **KEYBOARD PERC** and **PERC & EFFECT** sound groups do not have scaled pitches.
- **KN920/KN1500: SOUND MEMORY 201** to **240** are reserved for storing sounds you create yourself. (Refer to page 106.)

Assigning parts to the keyboard

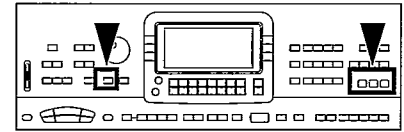

The **CONDUCTOR** buttons are used to assign sounds to the keyboard in many different ways. For example, you can assign two sounds to the entire keyboard so that playing one key will produce two sounds. You can even split the keyboard into right and left sections (**SPLIT**), and assign a different sound to each section.

CONDUCTOR

CONDUCTOR settings	How sounds are assigned to the keyboard
	All keys produce the RIGHT 1 sound. <div style="border: 1px solid black; padding: 10px; text-align: center;"> RIGHT 1 </div>
	All keys produce the RIGHT 2 sound. <div style="border: 1px solid black; padding: 10px; text-align: center;"> RIGHT 2 </div>
	All keys produce both the RIGHT 1 sound and the RIGHT 2 sound. <div style="border: 1px solid black; padding: 10px; text-align: center;"> RIGHT 1 + RIGHT 2 </div>
	The left keys produce the LEFT sound and the right keys produce the RIGHT 1 sound and the RIGHT 2 sound. <div style="display: flex; justify-content: space-around;"> <div style="border: 1px solid black; padding: 10px; text-align: center;"> LEFT </div> <div style="border: 1px solid black; padding: 10px; text-align: center;"> RIGHT 1 + RIGHT 2 </div> </div>
	The left keys produce the LEFT sound and the right keys produce the RIGHT 1 sound. <div style="display: flex; justify-content: space-around;"> <div style="border: 1px solid black; padding: 10px; text-align: center;"> LEFT </div> <div style="border: 1px solid black; padding: 10px; text-align: center;"> RIGHT 1 </div> </div>
	The left keys produce the LEFT sound and the right keys produce the RIGHT 2 sound. <div style="display: flex; justify-content: space-around;"> <div style="border: 1px solid black; padding: 10px; text-align: center;"> LEFT </div> <div style="border: 1px solid black; padding: 10px; text-align: center;"> RIGHT 2 </div> </div>

- The volume for each part can be adjusted independently. (Refer to page 30.)
- The following conditions are in effect when the **AUTO PLAY CHORD** is used.
ONE FINGER, FINGERED mode: You cannot assign sounds to all the keys.
PIANIST mode: The keyboard cannot be split.

SPLIT POINT

When the keyboard is divided into left and right sections, the split point is normally at C3 (indicated by ▼).

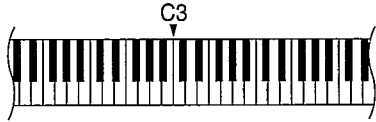

■ Customized split point

You can set a different split point.

1. Press the **SPLIT POINT** button.

SPLIT
POINT



- The following display appears.

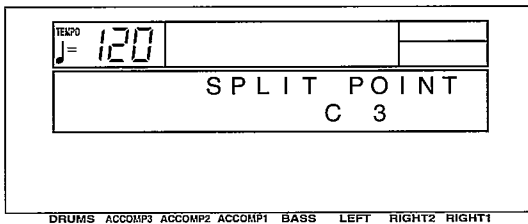

2. Specify the name of the desired split point note by pressing the corresponding key on the keyboard.
 - The specified note name is shown on the display.
 - A split point is set at the location of the pressed key, which is the lowest note of the right keyboard section.
 - The display returns to the previous display after a few seconds.

Effects

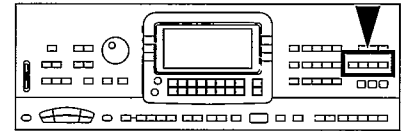

You can achieve even fuller and stirring sounds by adding various effects.

DIGITAL EFFECT

DIGITAL EFFECT gives the sound richness and enhances your performance.

1. Use the **SOUND/PART** button to select the part to which is effect will be applied.
2. Press the **DIGITAL EFFECT** button to turn it on for the selected part.

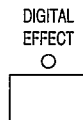

- The **DIGITAL EFFECT** on or off status is preset for each sound, so that the **DIGITAL EFFECT** automatically turns on when certain sounds are selected.
- This effect differs depending on the selected sound.
- This effect does not work for the **KEYBOARD PERC** sounds.

CHORUS (KN720)

Add breadth to the sound.

1. Use the **SOUND/PART** button to select the part to which is effect will be applied.
2. Press the **CHORUS** button to turn it on for the selected part.



- The **CHORUS** can be set to on or off for each part.

■ Effect setting

You can specify the type and adjust the parameters of this effect.

1. Press and hold the **CHORUS** button for a few seconds.
- The display looks similar to the following.

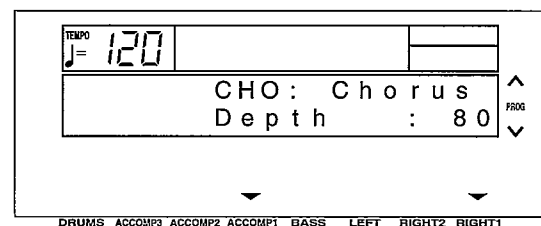

2. Use the **TRANSPOSE (PROG)** ^ and v buttons to select the type.
3. Use the **ACCOMP 1** ^ and v buttons to select a parameter.
4. Use the **RIGHT 1** ^ and v buttons to modify the parameter.
 - An explanation of the types and their corresponding parameters can be found in the separate **REFERENCE GUIDE** provided.
 - The depth of the effect can be adjusted for each part. (Refer to page 102.)
 - The display returns to the previous display after a few seconds.

DSP EFFECT (KN920/KN1500)

Add a unique quality to the sound.

1. Use the **SOUND/PART** button to select the part to which is effect will be applied.
2. Press the **DSP EFFECT** button to turn it on.

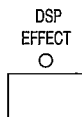

- This effect can be set to on or off for each part.

■ Effect Setting

You can specify the type and adjust the parameters of this effect.

1. Press and hold the **DSP EFFECT** button for a few seconds.
- The display looks similar to the following.

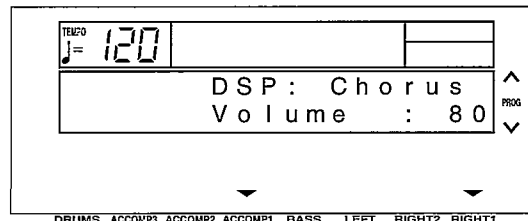

2. Use the **TRANSPOSE (PROG)** ^ and v buttons to select the type.
3. Use the **ACCOMP 1** ^ and v buttons to select a parameter.
4. Use the **RIGHT 1** ^ and v buttons to modify the parameter.
 - An explanation of the types and their corresponding parameters can be found in the separate REFERENCE GUIDE provided.
 - The depth of the effect can be adjusted for each part. (Refer to page 102.)
 - The display returns to the previous display after a few seconds.

SUSTAIN

Sustain is the gradual fading out of musical tones after the key is released.

1. Use the **SOUND/PART** button to select the part to which is effect will be applied.



2. Press the **SUSTAIN** button to turn it on.

- The **SUSTAIN** can be set to on or off for each part.
- This effect does not work for the sounds in the **KEYBOARD PERC** sound group.
- This effect differs depending on the selected sound.
- The display can also be used to adjust the length of sustain. (Refer to page 102.)
- In the initialized state, this effect can be turned on and off with the optional Foot Switch (sold separately).

DIGITAL REVERB

DIGITAL REVERB applies a reverberation effect to the sound.

Press the **DIGITAL REVERB** button to turn it on.

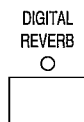

- This effect is applied to all the sounds of this instrument.
- The display can also be used to adjust the depth of the reverb for each part. (Refer to page 102.)

■ Effect Setting

You can select the type and adjust the parameters of this effect.

1. Press and hold the **DIGITAL REVERB** button for a few seconds.
- The display looks similar to the following.

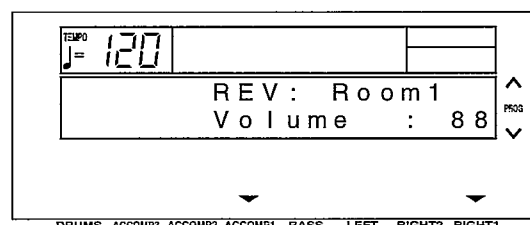

(KN920/KN1500)

2. Use the **TRANSPOSE (PROG)** ^ and v buttons to select the type.
3. **KN920/KN1500:** Use the **ACCOMP 1** ^ and v buttons to select the parameter.
4. Use the **RIGHT 1** ^ and v buttons to modify the parameter.
 - An explanation of the types and their corresponding parameters can be found in the separate REFERENCE GUIDE provided.
 - **KN720:** Only the [Volume] setting can be changed.
 - The display returns to the previous display after a few seconds.

PITCH BEND

The pitch of the instrument can be continuously changed with the **PITCH BEND** wheel at the left end of the keyboard. Using this control, you can produce the effect of bending the strings on a guitar.

While pressing a key on the keyboard, move the wheel up and down to control the pitch.

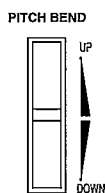

- When you release your hand from the wheel, it returns automatically to the center position and the pitch bend effect is turned off.
- The pitch bend effect does not function for the **AUTO PLAY CHORD** accompaniment pattern and for the sounds of the **LEFT** part.
- The amount of pitch bend can be set. (Refer to page 102.)

MODULATION (KN1500)

The **MODULATION** wheel is used to apply a vibrato effect, for example, to the sound.

While pressing a key on the keyboard, move the wheel up to add the effect.

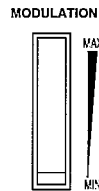

- When this effect is not needed, set the **MODULATION** wheel to the **MIN** position.
- This effect differs depending on the selected sound.
- The vibrato effect does not function for the **AUTO PLAY CHORD** accompaniment pattern and for the sounds of the **LEFT** part.

Transpose

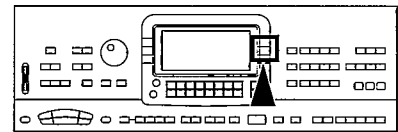

The **TRANSPOSE** buttons are used to change the key of the entire instrument in semitone steps across an entire octave.

Suppose you learn to play a song—in the key of C, for example—and decide you want to sing it, only to find that it's either too high or too low for your voice. Your choice is to either learn the song all over again in a different key, or to use the **TRANSPOSE** feature.

Adjust the key with the **TRANSPOSE** \wedge and \vee buttons.

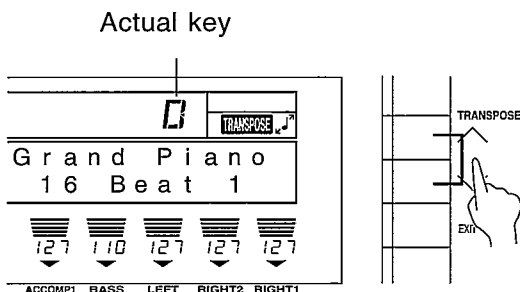

- Each press of the \wedge button raises the key in semitone steps, and each press of the \vee button lowers the key in semitone steps (G — C — F \sharp).
- If the two buttons are pressed at the same time, the key returns to C.
- When the **TRANSPOSE** function is active, TRANSPOSE is shown in the upper right part of the display and, during setting, the key is indicated.

<Example: transposed to D>

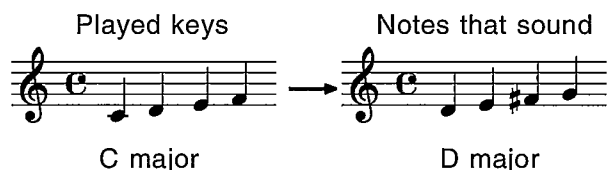

Techni-chord

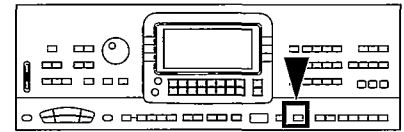

TECHNI-CHORD turns your single-note melodies into full chords and offers you a choice of 13 different types, from a simple duet which adds one harmony note to your melody note, to big band reeds which adds four harmony notes to your melody note. If **TECHNI-CHORD** is part of a **ONE TOUCH PLAY** or **MUSIC STYLE SELECT (KN1500)** registration, a suitable **TECHNI-CHORD** type will be selected automatically.

1. Split the keyboard into left and right sections.
(Refer to page 36.)
2. Press the **TECHNI-CHORD** button to turn it on.

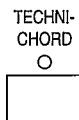

3. Play the keyboard.
 - The melody you play with your right hand is automatically played in chords which are based on the chords you play with your left hand.

Example:

Left hand (chord)

Right hand (melody)



- This feature is very effective when used with the **AUTO PLAY CHORD**. (This feature does not work in the PIANIST mode.)

■ Harmony type

You can select the desired harmony style for the **TECHNI-CHORD**.

1. Press and hold the **TECHNI-CHORD** button for a few seconds.

- The display looks similar to the following.

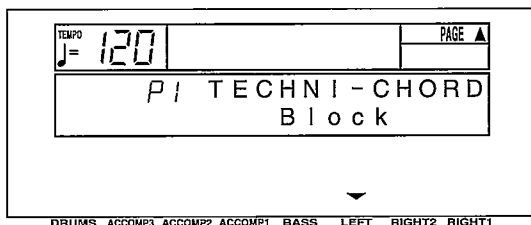

2. Use the **LEFT** \wedge and \vee buttons to select the harmony type.

- Select from [Close], [Open 1], [Open 2], [Duet], [Country], [Theatre], [Hymn], [Block], [Big Band Brass], [Big Band Reeds], [Octave], [Hard Rock], [Fanfare].
- When the [Octave], [Hard Rock] or [Fanfare] type is selected, the **TECHNI-CHORD** functions even when the keyboard is not split.
- The display returns to the previous display after a few seconds.
- An explanation of each harmony type can be found in the separate REFERENCE GUIDE provided.

<ORCHESTRATOR>

Use this function to specify which part plays the harmony notes. By assigning different sounds to the melody notes and harmony notes, you can achieve a striking **TECHNI-CHORD** performance.

1. While the **TECHNI-CHORD** display is shown, press the **PAGE** \wedge button.

- The display looks similar to the following.

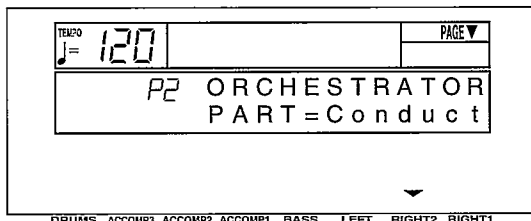

2. Use the **RIGHT 2** \wedge and \vee buttons to select the part you wish to generate the harmony notes.

- **LEFT** and **PART 16** cannot be selected.
- If [Conduct] is selected, the **CONDUCTOR** part which is currently selected will be specified as the part for the harmony notes. However, when **RIGHT 1** and **RIGHT 2** are both on, the harmony notes are produced in the sound for the **RIGHT 1** part.



Part II Manual Sequence Pads

During your performance, you can insert a short recorded phrase or effect sounds by pressing a pad button. Several types of phrases have been prerecorded, but you can also create your own phrases and store them.

Playing phrases

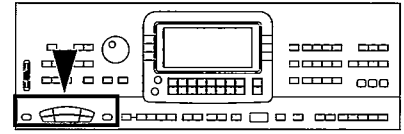

1. In the **MANUAL SEQUENCE PADS** section, press the **SELECT** button.



- The display looks similar to the following.

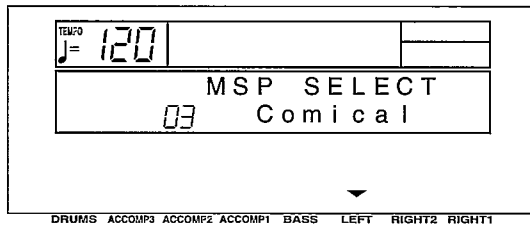

2. Use the **LEFT** \wedge and \vee buttons to select the desired phrase bank number.
- The list of bank names and their corresponding numbers is found on the upper part of the operation panel.
 - Bank [13 User] is reserved for storing your original phrases.
 - The display returns to the previous display after a few seconds.

3. Press a pad button (**KN720**: 1 to 4; **KN920/KN1500**: 1 to 6).

KN720

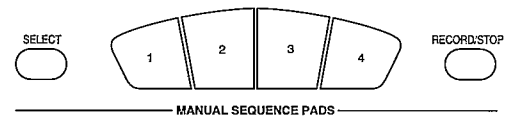

KN920/KN1500

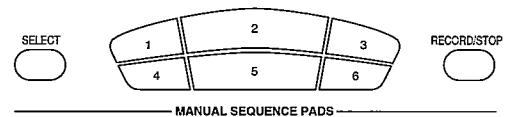

- A different phrase is played by each pad button.
- The selected phrase is played in the current tempo.
- To stop the phrase before it has ended, press the **RECORD/STOP** button.
- Some phrases continue to play until the **RECORD/STOP** button is pressed.
- Some phrases are programmed to begin playing in time with the measure count during a rhythm performance.
- When the **AUTO PLAY CHORD** is on, the phrase is played in the specified chord.
- On the normal display, if you press the **OTHER PARTS/TRACKS** button, the volume of the **MANUAL SEQUENCE PADS** (MSP) can be adjusted. (Refer to page 31.)

Record a phrase

Bank 13 is reserved for storing your original phrases.

1. Use the **TEMPO** buttons or **TEMPO/PROGRAM** dial (KN1500) to adjust the recording tempo.
2. Press the **SELECT** button. On the MSP SELECT display, select [13 User].
3. While pressing the **RECORD/STOP** button, press the pad button in which you wish to record.
 - There are two types of pads: For one type, the phrase is not timed to begin playing with the measure count. For the other type, the phrase starts to play in time with the measure count.

KN720: Phrases in pad buttons **1** and **2** are not timed to begin playing with the measure count; phrases in **3** and **4** are synchronized with the measure count.

KN920/KN1500: Phrases in pad buttons **1**, **2** and **3** are not timed to begin playing with the measure count; phrases in **4**, **5** and **6** are synchronized with the measure count.
 - The display looks similar to the following.

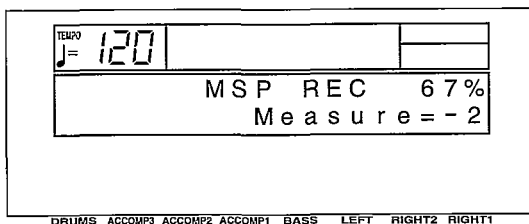

4. Select the sound for the phrase you are going to record.
5. Press the **START/STOP** button.



- After a two-measure count (Measure = -2, -1), recording begins.

6. Play the phrase.
7. When you have finished recording the phrase, press the **START/STOP** button.
 - You can also stop recording by pressing the **RECORD/STOP** button.
8. Repeat steps 3 to 7 to record phrases in the other pad buttons as desired.
 - The following information is stored.
 - Your keyboard performance
 - Sound settings and changes
 - **SUSTAIN** setting
 - **PITCH BEND, MODULATION (KN1500)** wheel operation, etc.
 - The memory capacity of the user bank is approximately 1200 notes. The remaining memory available for recording is shown on the MSP REC display as a percentage (%). When “MEMORY FULL!” appears on the display, no more data can be stored.



Part III Playing the rhythm

The rhythm section enhances the capabilities of this instrument with features such as automatic performance of the preset rhythm patterns and accompaniment patterns.

Selecting rhythms

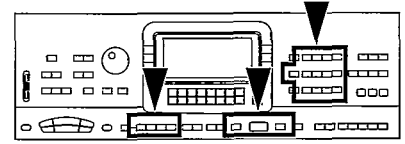

Select a rhythm

1. Press the **RHYTHM** button to turn it on.



2. On the number pad (**0 to 9**), press the buttons to select the desired rhythm (3 digits).

- The list of rhythm group names and their corresponding numbers is found on the upper part of the operation panel.
- A list of all the rhythms and their numbers can be found in the separate REFERENCE GUIDE provided.

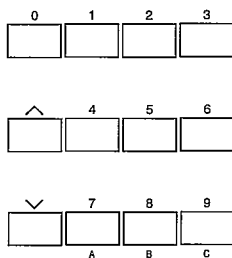

- Enter three digits to select the rhythm. For example, to select rhythm **003**, press **0, 0, 3**. To select rhythm **030**, press **0, 3, 0**.
- Do not enter the digits too slowly. If you wait too long after entering a number before entering the next number, the first number will be canceled.
- During setting, the selected number and rhythm name are shown on the display.
- **KN920/KN1500**: A **COMPOSER** rhythm or **COMPOSER CHORD MAP** can also be selected as a rhythm. (Refer to pages 83 and 85.)

■ ^ and v buttons

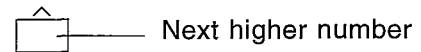

- Keep the ^ or v button pressed to scroll the numbers quickly.

VARIATION

For each rhythm, variations with difference nuances are available.

- You can change to a different variation while the rhythm is playing.

KN720: Turn on the **VARIATION** button to play the rhythm variation.

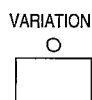

KN920/KN1500: Use the **VARIATION & MSA** buttons to choose from four different variations.

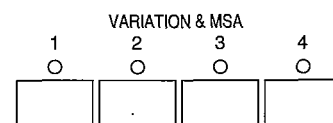

Start the rhythm

There are two ways to start the rhythm.

■ Immediate rhythm start

1. Select a rhythm.
2. Press the **START/STOP** button to turn it on.



- The selected rhythm pattern immediately begins to play.
- You can stop the rhythm by pressing the **START/STOP** button again to turn it off.
- The **BEAT** indicators above the **START/STOP** button light to indicate the beat. On the first beat of the measure, the red indicator lights. On the second and succeeding beats of the measure, the green indicators light in order.

■ Synchronized start

With the synchronized start feature, the rhythm pattern starts when you play a key on the keyboard.

1. Select a rhythm.
2. Press the **SYNCHRO & BREAK** button to turn it on.

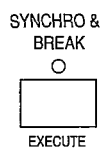

3. Play a key to the left of the keyboard split point.

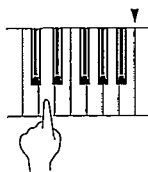

- The rhythm pattern begins to play.
- You can use the synchronized start feature even when the keyboard is not divided into left and right sections. To start the rhythm, press a key to the left of the specified split point.

■ Adjust the tempo

The tempo of the rhythm pattern is adjusted with the **TEMPO** \wedge and \vee buttons.

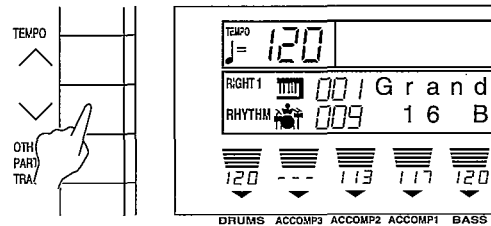

- The tempo is shown on the display as a numerical value (♩ = 40 to 300).
- Keep the button pressed to change the value quickly.
- If the two buttons are pressed at the same time, the tempo returns to the standard 120 setting.
- **KN1500:** The **TEMPO/PROGRAM** dial can also be used to adjust the tempo of the rhythm pattern.

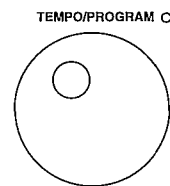

- When the **TEMPO/PROGRAM** indicator is lit, the **TEMPO/PROGRAM** dial is used for setting functions and cannot be used to adjust the tempo.

■ TAP TEMPO (KN1500)

You can set the tempo of the rhythm by tapping this button few times with your finger.



- The tempo at which the button is tapped is detected, and the tempo automatically changes correspondingly.



Playing the rhythm

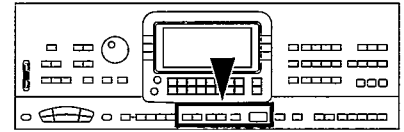

Intro, fill-in and ending patterns fitting each different rhythm pattern are permanently recorded in your instrument, thus allowing a versatile rhythm performance.

INTRO

Begin the rhythm performance with an intro pattern.

1. Press the **INTRO & ENDING (KN720)/INTRO & ENDING 1 or 2 (KN920/KN1500)** button to turn it on.

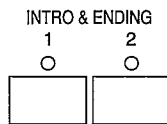

(KN920/KN1500)

2. Press the **START/STOP** button to start the rhythm.



- An intro pattern is played, after which the normal rhythm pattern begins.

COUNT INTRO

You can begin the rhythm performance with a one-measure count.

1. Press the **COUNT INTRO (FILL IN 2)** button to turn it on.

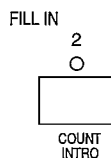

2. Press the **START/STOP** button to start the rhythm.

- A one-measure count is played, after which the normal rhythm pattern begins.

FILL IN

You can insert a fill-in pattern any time during the rhythm performance. Choose from two different fill-in patterns.

1. Select a rhythm and press the **START/STOP** button.

2. Press the **FILL IN 1 or 2** button.

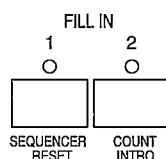

- A fill-in pattern is heard immediately for the remainder of the measure.
- When a **FILL IN** button is pressed on the last beat of the measure, the fill-in pattern continues to the end of the following measure.

ENDING

Finish the rhythm performance with an ending pattern.

1. Select a rhythm and press the **START/STOP** button.
2. Press the **INTRO & ENDING (KN720)/INTRO & ENDING 1 or 2 (KN920/KN1500)** button to turn it on.

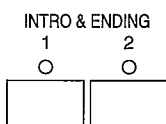

(KN920/KN1500)

- An ending pattern is produced, and then the rhythm performance stops.
- If you accidentally press an **INTRO & ENDING** button in the middle of the tune, you can press the **FILL IN 1 or 2** button. The ending pattern stops, and a fill-in pattern is produced, after which the normal rhythm performance continues.

Auto Play Chord

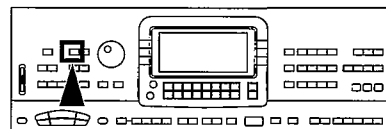

Simply by playing a chord on the keyboard, the **AUTO PLAY CHORD** function automatically plays an accompaniment pattern which matches perfectly the selected rhythm. With a real accompaniment as a background, you can concentrate on playing the melody.

How the AUTO PLAY CHORD works

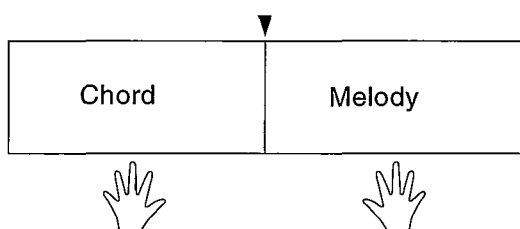

When an **AUTO PLAY CHORD** mode is selected, an automatic accompaniment which matches the rhythm you have chosen is played in the chord which you specify with your left hand. The melody is played with your right hand.

- The accompaniment pattern of the **AUTO PLAY CHORD** is composed of five parts: **DRUMS, BASS, ACCOMP 1, ACCOMP 2** and **ACCOMP 3**.

Playing chords

Choose from three ways of playing chords.

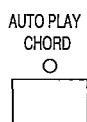

■ **ONE FINGER mode**

In the [1 Finger] mode, a major chord can be played just by pressing the key for its root note.

Example: C chord

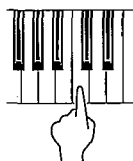

Minor, seventh and minor seventh chords are also easily produced.

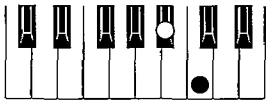
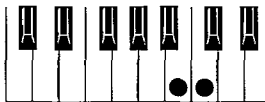
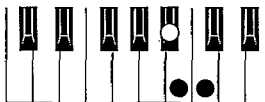
minor chord	seventh chord	minor seventh chord
Play the root note plus a black key to the left of it.	Play the root note plus a white key to the left of it.	Play the root note plus a black key and a white key to the left of it.
Example: Cm 	Example: C7 	Example: Cm7 

■ **FINGERED mode**

In the [Fingered] mode, you specify the chord by playing all the notes in the chord.

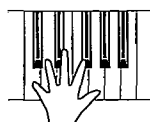

- The Keyboard can distinguish the following played chords for each key (C is given as an example): C, C7, CM7, Caug, Caug7, Cm, Cm7, Cdim, Cm7^{b5}, CmM7, Csus4, C7sus4, C^{b5}, C7^{b5}, Cm^{b5}, C6, Cm6, CM7^{b5}, CM7^{#5}, CmM7^{b5}, etc.

■ **PIANIST mode**

In the [Pianist] mode, the entire keyboard can be used to specify chords (FINGERED mode) for the automatic accompaniment; a **RIGHT** part is assigned to all the keys, and the keyboard does not split. In addition to the chords in the [Fingered] mode, the Keyboard also recognizes 9th and 13th chords.

- When specifying chords, if you press a key a perfect 5th or more below the lowest note of the chord, the **BASS** part becomes a pattern based on that note.

<ON BASS>



If the **ON BASS** button is on while the [Fingered] or [Pianist] mode is selected, the **BASS** part is produced in the key of the lowest note of the played chord, thus making it possible to play chords such as "C on G" with just one hand.

- For example, with the **ON BASS** button on, if you play a C chord by pressing the keys G, C and E, the **BASS** part is produced in the key of G.

<MEMORY>

When the MEMORY (MEM) function is on, even when the keys are released, the chord is memorized and the accompaniment continues to play until you specify another chord.

How to use the AUTO PLAY CHORD

1. Select the desired rhythm and sound(s), and set the tempo.
2. Press the **AUTO PLAY CHORD** button to turn it on.

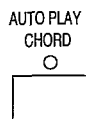

- The display looks similar to the following.

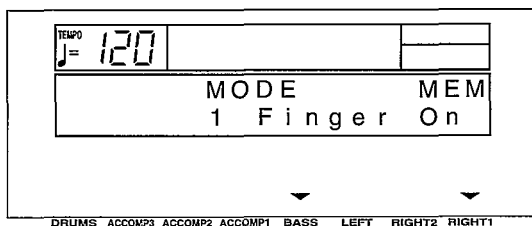

3. Use the **BASS** \wedge and \vee buttons to select the **AUTO PLAY CHORD** mode.
 - Use the **RIGHT 1 (MEM)** \wedge and \vee buttons to set MEMORY to on or off.
 - After a few seconds, the display returns to the previous display.
4. Press the **START/STOP** button to begin the rhythm.
 - You can also start the rhythm by playing a key on the keyboard. (Refer to page 47.)

5. Specify a chord.

- If the [1 Finger] or [Fingered] mode was selected, specify the chord on the keyboard section to the left of the split point.

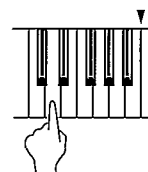

- The split point can be changed. (Refer to page 37.)
 - An accompaniment pattern in the specified chord is automatically played.
 - When you use **FILL IN**, **INTRO** and **ENDING**, the automatic accompaniment is also used in these patterns.
 - You can set the mode which determines how the **LEFT** part sounds during an **AUTO PLAY CHORD** performance. (Refer to page 105.)
 - If the **AUTO PLAY CHORD** button is pressed during an automatic accompaniment, the button does not turn off, and the display changes to the mode-setting display.
6. To stop the automatic accompaniment, press the **START/STOP** button.
 - When the rhythm is off, if the [1 Finger] or [Fingered] mode is on and a chord is specified, the specified root note (R. BASS part) and chord notes (CHORD part) are produced. The volumes of these notes can be adjusted. (Refer to page 102.)

BREAK function

With the break function, the rhythm starts when the left keyboard is played and stops when the fingers are removed from the keys.

1. Select an **AUTO PLAY CHORD** mode.
 - At this time, the MEMORY function should be off.
2. Press the **SYNCHRO & BREAK** button to turn it on.

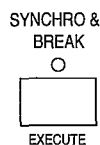

3. Specify a chord.

- The automatic accompaniment begins to play (synchronized start).
- For the [Pianist] mode, play the keys to the left of the currently set split point.

4. Release the chord keys.

- The automatic accompaniment stops. When the keys are pressed again, the rhythm starts from the first beat.

Sound Arranger

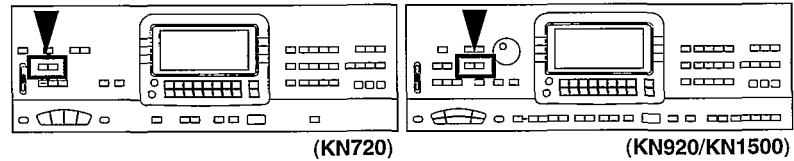

The **SOUND ARRANGER** feature lets you select other sounds for the **AUTO PLAY CHORD** parts of each rhythm.

Setting the sounds

1. Select the rhythm whose sound you wish to change.
 - **KN920/KN1500**: Do not select a **COMPOSER** rhythm or a **COMPOSER CHORD MAP**.
2. In the **SOUND ARRANGER**, press the **SET** button to turn it on.

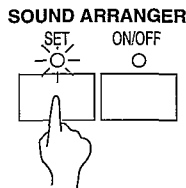

- The display changes to the following.

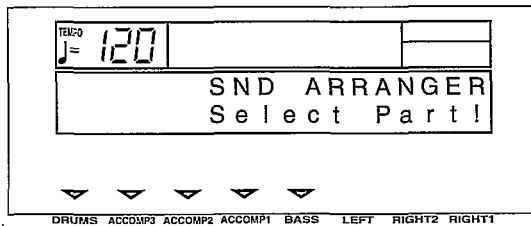

3. Use the balance buttons below the display to select the part whose sound you wish to change.
 - Select from **BASS**, **ACCOMP 1**, **ACCOMP 2**, **ACCOMP 3** and **DRUMS**.

- The display changes to the following.

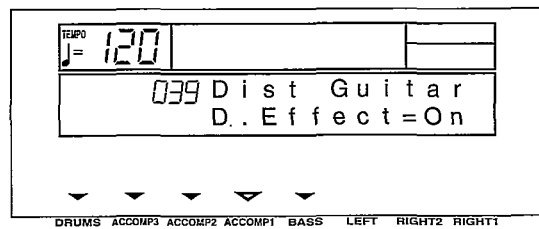

- The ▼ mark for the selected part only flashes.
4. Select the desired sound.
 - The **DIGITAL EFFECT** on/off status can also be specified (except for **DRUMS** part).
 - For the **DRUMS** part, select sounds from the **KEYBOARD PERC** sounds. (These sounds cannot be selected for other parts.)
 - The sound and on/off status of the **DIGITAL EFFECT** are shown on the display.
 - Depending on the selected sound, the sound quality may differ from that during a normal performance.
 5. Repeat steps 3 and 4 for the other parts as desired.
 6. When you have finished selecting the sounds, press the **SET** button to turn it off.

Playing back the sounds

1. In the **SOUND ARRANGER**, press the **ON/OFF** button to turn it on.

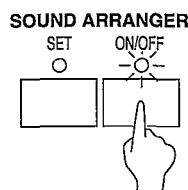

2. Start the rhythm (automatic accompaniment).
 - When the **ON/OFF** button is off, the factory-preset sounds are produced.
 - The **ON/OFF** setting is memorized for each rhythm.

One Touch Play

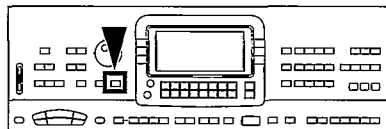

ONE TOUCH PLAY sets up the your instrument with a suitable registration for your chosen rhythm style so that you can make a great sound straight away, even if you are playing this instrument for the first time. Using **ONE TOUCH PLAY** sets a suggested combination of sounds and balances and an appropriate tempo for the rhythm style at the push of a button.

1. Select a rhythm pattern.
 - **KN920/KN1500:** Do not select a **COMPOSER** rhythm or a **COMPOSER CHORD MAP**.
2. Press and hold the **ONE TOUCH PLAY** button for a few seconds until the panel settings change.

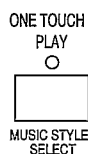

(KN1500)

- The display looks similar to the following.

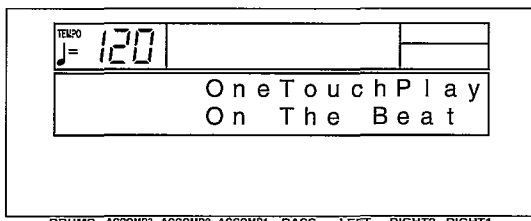

- The **AUTO PLAY CHORD** button and the **SYNCHRO & BREAK** button are automatically turned on. When a key on the left section of the keyboard is pressed, the automatic rhythm begins to play immediately.
- The octave and stereo balance of the sound may change.
- To return the functions of this instrument to their original settings, perform the **INITIAL** procedure. (Refer to page 122.)

Suggestions for using ONE TOUCH PLAY

Press the **INTRO & ENDING** button before you play for a professional sounding introduction. Use the **ONE TOUCH PLAY** registration as a starting point for your own registration. Alter the sounds, balance and tempo to your own taste and store your new registration in the **PANEL MEMORY** for future use. (Refer to page 56.)



Music Style Arranger

(KN920/KN1500)

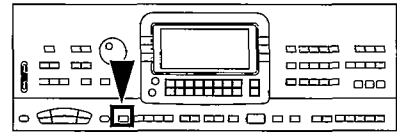

The **MUSIC STYLE ARRANGER** helps you to make professional registration changes during your performance. Select from four contrasting registrations at the push of a button, or let your instrument change the registration automatically for you when you use **FILL IN 1** or **2**. The **MUSIC STYLE ARRANGER** will also alter the accompaniment in character with the registration change, creating a polished sounding arrangement.

How to use the MUSIC STYLE ARRANGER

1. Select a rhythm pattern.
2. Press the **MUSIC STYLE ARRANGER** button to turn it on.

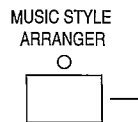

3. Use the **VARIATION & MSA** buttons to select a style (1 to 4).

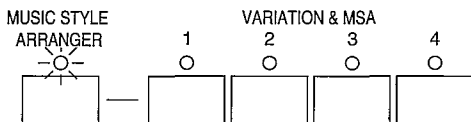

- The nuance of the pattern differs with each number.
- The panel settings (including the tempo) change according to the selected rhythm and music style. The **AUTO PLAY CHORD** button and the **SYNCHRO & BREAK** button are automatically turned on. When a key on the left section of the keyboard is pressed, the automatic rhythm begins to play immediately.
- The octave and stereo balance of the sound may change.
- To return the functions of this instrument to their original settings, perform the INITIAL procedure. (Refer to page 122.)
- During your performance, the style can be changed, but the tempo does not change.

How to change the music style during your performance

While you are playing the keyboard with the **MUSIC STYLE ARRANGER** on, press the **FILL IN 1** or **2** button.

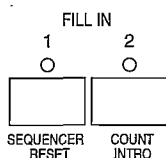

- Each time the **FILL IN 1** button is pressed, the **FILL IN 1** pattern plays, and then the music style changes in the 4 → 3 → 2 → 1 order. And each time the **FILL IN 2** button is pressed, the **FILL IN 2** pattern plays, and then the style changes in the 1 → 2 → 3 → 4 order.

■ **MUSIC STYLE ARRANGER mode**
You can define which panel settings change by pressing a **FILL IN** button when the **MUSIC STYLE ARRANGER** is used.

1. Press and hold the **MUSIC STYLE ARRANGER** button for a few seconds.
- The display changes to the following.

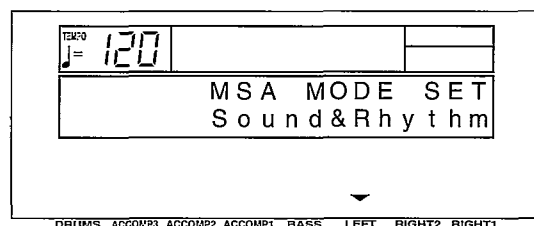

(continued on the next page)

2. Use the **LEFT** \wedge and \vee buttons to select the mode.
 - [Rhythm]: Only the rhythm changes.
 - [Sound & Rhythm]: Both the sound and rhythm change.
 - [Panel Memory]: The **PANEL MEMORY** number changes (**A1** to **A4**).
- After a few seconds, the display exits the setting mode.

Panel Memory

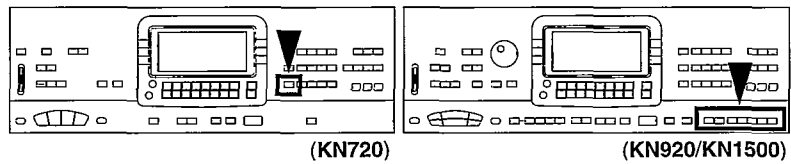

PANEL MEMORY stores the panel set up of this instrument allowing you to make complex changes at the push of a single button.

How to store the panel settings

<KN720>

Store a different panel setting in each of the number buttons (**0** to **9**).

1. Set up the desired panel settings (sounds, volumes, etc.)
2. While pressing the **PANEL MEMORY** button, press the number button for the memory you want to store (**0** to **9**).

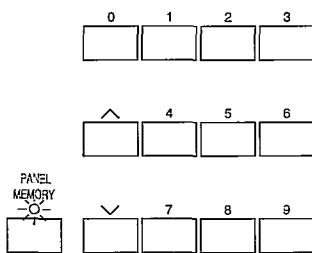

- The current panel settings are now stored in the specified **PANEL MEMORY** number. To recall the stored settings, just turn on the **PANEL MEMORY** button, and press the number for the desired panel setup.

<KN920/KN1500>

Five panel setups can be stored in each of the two banks (**A** and **B**).

1. Set up the desired panel settings (sounds, volumes, etc.)
2. Use the **BANK** button in the **PANEL MEMORY** section to select a bank (**A** or **B**).
3. While pressing the **SET** button, press a number button (**1** to **5**) for the memory you want to store.

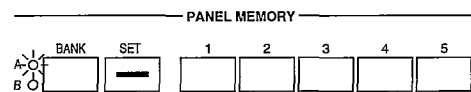

- The current panel settings are now stored in the specified bank and number. To recall the stored settings, select the **BANK** and specify the number.

- The recalled settings can be changed manually; however the memory contents of the **PANEL MEMORY** remain unchanged until you store them again.
- **KN720**: The contents stored in the **PANEL MEMORY** can be saved in this instrument's memory. (Refer to page 87.)
- **KN920/KN1500**: The **PANEL MEMORY** settings can be saved on a disk for recall at a later time. (Refer to page 89.)

■ PANEL MEMORY mode

You can define which panel settings are stored when the **PANEL MEMORY** is used.

1. Press and hold the **PANEL MEMORY** button (KN720)/**SET** button (KN920/KN1500) for a few seconds.
- The display changes to the following.

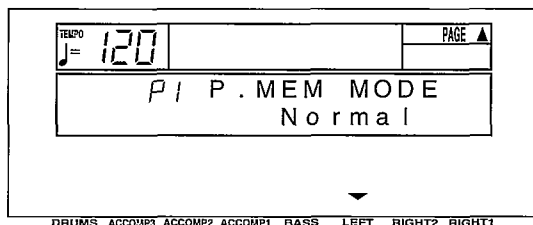

2. Use the **LEFT** ^ and v buttons to select the mode.

Normal: The sounds and volume balance, effects and **CONDUCTOR** status are stored.

Expand: All the instrument's settings are stored, including the rhythm, **TRANSPOSE**, tempo, etc.

- After a few seconds, the display exits the setting mode.

■ EXPAND MODE FILTER

You can specify which data is stored in the Expand mode.

1. While the P.MEM MODE display is shown, press the **PAGE** ^ button.
- The display looks similar to the following.

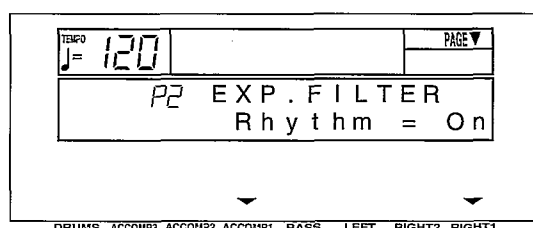

2. Use the **ACCOMP 1** ^ and v buttons to select the item.
 - Select from [Rhythm], [Tempo], [Split Pt] (SPLIT POINT), [Transpos], [APC&Mem] (AUTO PLAY CHORD & MEMORY), [MIDI], [Key Scale], [Reverb], [CHO Set] (CHORUS Setting) (KN720), [DSP Set] (KN920/KN1500), and [P4-P16 Set] (PART 4 to 16 Setting).
3. Use the **RIGHT 1** ^ and v buttons to store the on or off status for the selected item (On/Off).

4. Repeat steps 2 and 3 for each item, as desired.

Suggestions for using PANEL MEMORY

- The initial factory setting of **PANEL MEMORY** contains professional settings which you may choose to use or to alter to your own taste. These can be restored at any time by initializing the **PANEL MEMORY**. (Refer to page 122.)
- You can change from one **PANEL MEMORY** to another by pressing the optional Foot Switch (sold separately).

Foot Switch setting

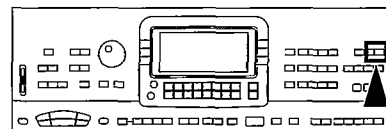

You can assign various functions to the optional Foot Switch (sold separately). The assigned function can then be controlled with the Foot Switch.

Assigning functions

1. Press the **MEMORY & CONTROL** button to turn it on.

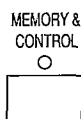

- The display changes to the following.

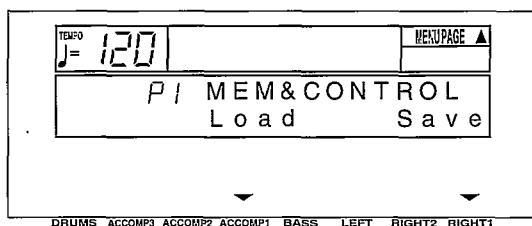

2. Use the **PAGE** buttons to select [P3 Foot Switch] (KN720)/[P5 Foot Switch] (KN920/KN1500).

- The display changes to the following.

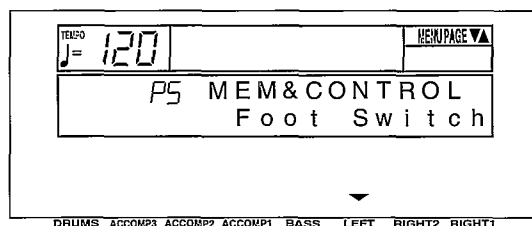

(KN920/KN1500)

3. Press either **LEFT** button.

- The display changes to the following.

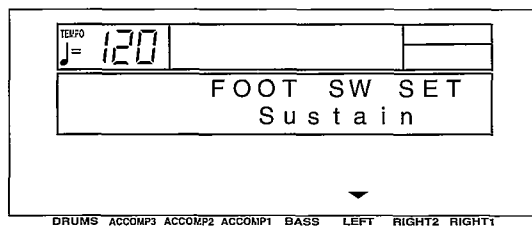

4. Use the **LEFT** ▲ and ▼ buttons to select a desired function.

[P. Memory] 0–9 (KN720)/A1–B5 (KN920/KN1500): The specified **PANEL MEMORY** number is turned on.

[P. Memory inc]: Increment the **PANEL MEMORY** selection by 1.

[Start/Stop]: **START/STOP** button on/off

[Rhythm Vari] (KN720): **VARIATION** button on/off

[Rhythm Vari 1–4] (KN920/KN1500): **VARIATION** button on

[Fill in 1]: **FILL IN 1** button on

[Fill in 2]: **FILL IN 2** button on

[Intro/Endng] (KN720): **INTRO & ENDING** button on

[Intro/Endng 1] (KN920/KN1500): **INTRO & ENDING 1** button on

[Intro/Endng 2] (KN920/KN1500): **INTRO & ENDING 2** button on

[Sustain]: **SUSTAIN** button on/off

[MSP] 1–4 (KN720)/1–6 (KN920/KN1500): Specified **MANUAL SEQUENCE PADS** button on

[Dig Effect]: **DIGITAL EFFECT** button on/off

[Chorus] (KN720): **CHORUS** button on/off

[DSP Effect] (KN920/KN1500): **DSP EFFECT** button on

[Glide]: Glide on/off (The glide effect “bends” the pitch down by about one semitone.)

[Techni-Chord]: **TECHNI-CHORD** button on/off

[Rotary Speed] (KN920/KN1500): **DSP EFFECT** rotary speed (Slow/Fast)

5. When you have completed making the settings, press the **MEMORY & CONTROL** button to turn it off.

1. Press the MEMORY & CONTROL button to turn it on.
 2. Use the PAGE buttons to select [P3 Foot Switch] (KN720)/[P5 Foot Switch] (KN920/KN1500).
 3. Press either LEFT button.
 4. Use the LEFT ▲ and ▼ buttons to select a desired function.
 5. When you have completed making the settings, press the MEMORY & CONTROL button to turn it off.

Part IV Sequencer

Outline of the Sequencer

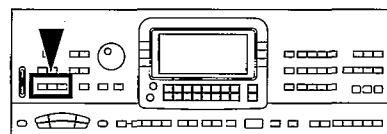

A sequencer records your performance in a similar way to a tape recorder. This instrument's **SEQUENCER** allows you to record up to 10 performances in a variety of ways. You may want to record your entire performance in one go (especially if you are using **AUTO PLAY CHORD** to provide the accompaniment), or to build up a complex arrangement with several different parts playing together, like an orchestral score. This instrument's **SEQUENCER** has 16 tracks. This means that you can record 16 different parts. However, you don't have to use all 16 tracks. For some uses you may only need to use one or two tracks. This instrument's **SEQUENCER** enables you to edit your recorded performance. Unlike a tape recorder you can change the sound or the tempo during playback, or correct wrong notes or timing errors.

SEQUENCER features

■ You can change the tempo without changing the pitch

When you record your performance at a slow tempo and play it back at a faster tempo, the pitch stays the same.

■ Consistent sound

Your performance is reproduced by a sound module as it reads digital data. So, unlike a recorded tape, the sound never deteriorates no matter how many times you play back your performance.

■ Edit your recorded performance

Comprehensive editing functions allow you to modify your recorded performance. Data can easily be erased, corrected or copied, providing an especially convenient tool for creating your original tunes.

■ Instant search

A recorded tape has to be rewound, but digital action means you can return to the beginning of your performance, or find any measure, instantly.

■ Save your performances on disks (KN920/KN1500)

All the data of your recorded performances can be stored on disks. The built-in Disk Drive also allows you to play back and use commercially sold disks on your own instrument.

- Features and operation of the built-in Disk Drive are explained in Part VII: Disk Drive (page 89).
- **KN720:** Your performance data can be stored in this instrument's memory. (Refer to page 87.)

Popular features

■ Simplified recording method

EASY RECORD is a feature that allows you to bypass the more complex recording procedures so you can record and play back your performance quickly and easily.

- You can also record an accompaniment from the **AUTO PLAY CHORD**.

■ Create a one-man ensemble

Use the **REALTIME RECORD** function to record your performance in up to 16 tracks and create your own orchestra or band.

■ Store a chord progression

Use the **STEP RECORD** to store a chord progression for the automatic accompaniment, and the rhythm changes, note by note.

Memory capacity

Up to 10 songs can be stored in the **SEQUENCER**. Expressed in terms of notes, the total number of notes which can be stored in all the **SEQUENCER** songs and tracks is about 10,000 (**KN720**)/30,000 (**KN920/KN1500**). The remaining memory available for recording is shown on the display as a percentage.

- When "MEMORY FULL!" appears on the display, no more data can be stored in the **SEQUENCER**.



About the measure count

The measure count on the display corresponds to the time signature of the selected rhythm. However, if rhythm data is stored in the RHYTHM part and that part is played back, the measure count on the display corresponds to the stored rhythm data. (Refer to page 71.)

- **KN920/KN1500:** If you wish to use a time signature not available in the preset rhythms, use the **COMPOSER** to create a new time signature. (Refer to page 77.)

SEQUENCER MENU

When you press the **MENU** button in the **SEQUENCER** section to turn it on, the display changes to the following.

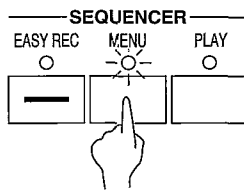

- Use the **PAGE** buttons to view the three pages of menu display.

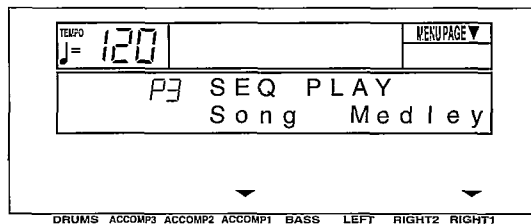
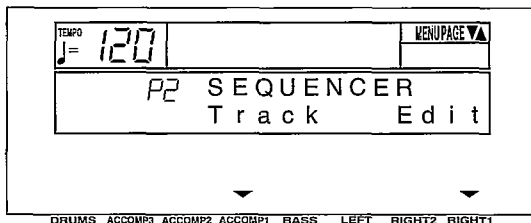
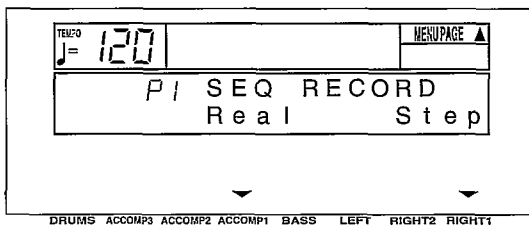

Summary of the SEQUENCER menu items

[P1 SEQ RECORD]

Real (REALTIME RECORD) (page 64)
Record your performance just as you play it on the keyboard.

Step (STEP RECORD) (page 68)
Store the chord progression for the automatic accompaniment, and the rhythm changes.

[P2 SEQUENCER]

Track (TRACK ASSIGN) (page 72)
Assign parts to up to 16 different tracks.

Edit (page 73)
Full-scale editing features are available.

[Song Clear]: Erase the recorded contents of a specific song.

[Track Clear]: Erase the contents of a specific track.

[Quantize]: Correct the timing of the recorded performance.

[Song Copy]: Copy specific songs.

[Panel Write]: Modify the panel status at the beginning of the song.

[P3 SEQ PLAY]

Song (page 61)
Specify the song number and name of the song to record or play back.

Medley (page 76)
Specify medley playback of songs.

Song

Up to 10 songs can be recorded in the **SEQUENCER**. The song number and song name are specified before recording begins.

1. Press the **MENU** button in the **SEQUENCER** section to turn it on.
2. Use the **PAGE** buttons to select [P3 SEQ PLAY].
- The display looks similar to the following.

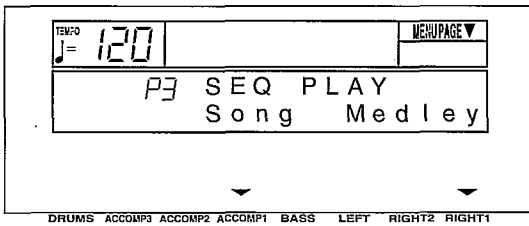

3. Press either **ACCOMP 1** button.
- The display looks similar to the following.

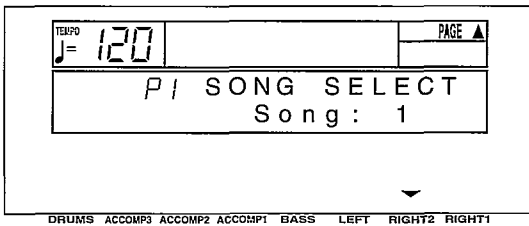

4. Use the **RIGHT 2** ^ and v buttons to select a song number (1 to 10).
5. If you wish to assign a name to the song, press the **PAGE** ^ button.
- The display looks similar to the following.

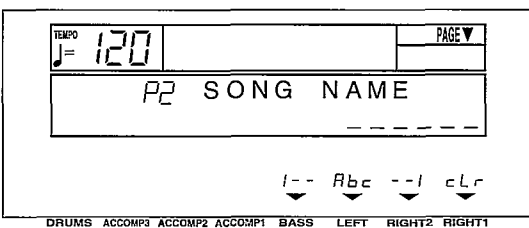

6. Assign a name to the song (up to 6 characters).
 - Use the **BASS** or **RIGHT 2** buttons to highlight the character position. Use the **LEFT** (Abc) buttons to select the alphanumeric character. Repeat these steps to type the whole name.
 - To erase the name, press either **RIGHT 1** (cLr) button.
7. Use the **EXIT** button to return to the MENU display.
8. Follow the procedures to record the song.
 - The same procedure is used to select the song to play back.
 - Until this procedure is repeated, all subsequent recording and playback procedures are associated with the specified song number.
 - To optimize memory, songs you do not wish to preserve should be deleted. (Refer to page 73.)



Easy Record

Suppose you are playing your instrument and you wish to record and play back your performance to hear how it sounds. You can bypass the set-up procedures of the full-scale sequencer and begin recording quickly and easily.

Recording procedure

1. Select the song number. (Refer to page 61.)
2. Set the desired sounds, effects, rhythms, etc.
3. In the **SEQUENCER** section, press the **EASY REC** button to turn it on.

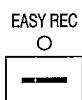

- The display changes to the following.

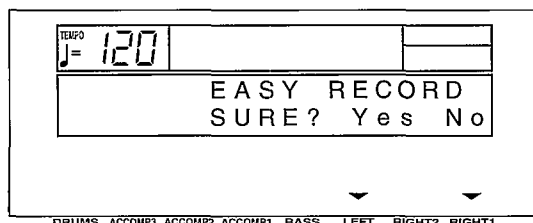

- EASY RECORD is not available if GENERAL MIDI is set to On. (Refer to page 120.)

Here is what happens when you select the EASY RECORD mode.

- The recorded data for the currently selected SONG number is erased (Song Clear).
- Tracks available for recording are selected as follows.
 - 1: RIGHT 1 part
 - 2: RIGHT 2 part
 - 3: LEFT part
 - 4: APC part
 - 5: CONTROL part
- 4. Press either **LEFT** (Yes) button.
 - To cancel the procedure, press either **RIGHT 1** (No) button.
 - The display changes to the REC display.
- 5. Play the keyboard.
 - Recording begins as soon as you start the rhythm or play the keyboard.
- 6. When you have finished recording, press the **EASY REC** button in the **SEQUENCER** section to turn it off.
 - The display changes to the SEQ PLAY display.

Playback

1. Press the **SEQUENCER RESET (FILL IN 1)** button.

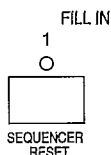

2. Press the **START/STOP** button.



- Your recorded performance is played back automatically.
- When you are finished playing back your performance, press the **PLAY** button in the **SEQUENCER** section to turn it off.

Sequencer parts

The following summary explains what is stored in each **SEQUENCER** part.

Part name [name on display]	Used for	Recorded contents
RIGHT1 [Right1] RIGHT2 [Right2] LEFT [Left] PART4 [Part 4] : PART15 [Part15]	Recording the performance of each part (REALTIME)	<ul style="list-style-type: none"> • Sound and volume settings • Sustain pedal operation • DIGITAL EFFECT, CHORUS (KN720), DSP EFFECT (KN920/KN1500) on/off • PITCH BEND wheel operation • MODULATION wheel operation (KN1500)
DRUM [Drum] (Part16)	Recording the drums performance with the KEYBOARD PERC group sounds (REALTIME)	<ul style="list-style-type: none"> • Sound (drum KIT) and volume settings
CONTROL [Control]	Recording changes in the panel button status (REALTIME)	<ul style="list-style-type: none"> • Rhythm setting and selection changes • VARIATION on/off (KN720) • VARIATION selection (KN920/KN1500) • DIGITAL REVERB on/off • AUTO PLAY CHORD status • ON BASS on/off • MUSIC STYLE ARRANGER status (KN920/KN1500) • FILL IN, INTRO & ENDING on • PANEL MEMORY selection changes • TRANSPOSE status • TECHNI-CHORD on/off • START/STOP on/off • TEMPO setting • CONDUCTOR status • MANUAL SEQUENCE PADS operation • Expression pedal operation (separately sold option) (KN1500)
AUTO PLAY CHORD [APC]	Recording chords for the AUTO PLAY CHORD (REALTIME)	<ul style="list-style-type: none"> • AUTO PLAY CHORD status • START/STOP on/off • FILL IN, INTRO & ENDING on
CHORD [Chord]	Recording the chord progression for the AUTO PLAY CHORD (STEP)	<ul style="list-style-type: none"> • Chord progression • FILL IN, INTRO & ENDING on
RHYTHM [Rhythm]	Settings related to rhythm (STEP)	<ul style="list-style-type: none"> • Rhythm settings and selection changes • VARIATION on/off (KN720) • VARIATION selection (KN920/KN1500) • TEMPO setting and changes • FILL IN, INTRO & ENDING on • START/STOP on/off

- You can use the **TRACK ASSIGN** function to assign parts to tracks as you wish. (Refer to page 72.)

■ Default part settings

1: RIGHT1	5: CONTROL	9: PART5	13: PART9
2: RIGHT2	6: RHYTHM	10: PART6	14: PART10
3: LEFT	7: DRUM	11: PART7	15: PART11
4: APC/CHORD	8: PART4	12: PART8	16: PART12



Realtime Record

With REALTIME RECORD, your performance is recorded with the timing exactly as you played it on the keyboard. And with the 16 tracks, you can even record your performance one track at a time (multi-track recording).

Recording procedure

1. Select a song number. (Refer to page 61.)
2. On the **SEQUENCER** menu display, select P1.
 - The display looks similar to the following.

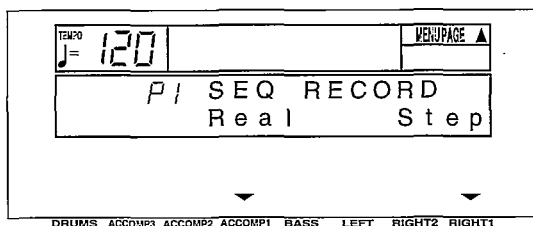

3. Press either **ACCOMP 1 (Real)** button.
 - The display looks similar to the following.

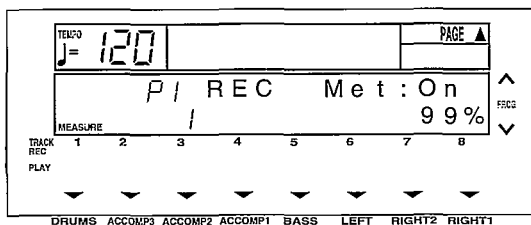

4. Use the buttons below the display to select the track numbers you are going to record.
 - In the REC row, turn on the horizontal bar for TRACK numbers you are going to record.
 - You can press the **OTHER PARTS/TRACKS** button to view the display for tracks 9 to 16.
 - While you are recording, you can play back tracks which are already recorded. In the PLAY row, turn on the horizontal bar for TRACK numbers you wish to have played back.
 - The part name for the selected recording track is shown on the display.
 - You can select two or more tracks to record at one time. For performance parts, use the **CONDUCTOR** buttons to turn on the parts for the selected tracks (you should be able to hear them).
 - When recording a track for the **AUTO PLAY CHORD (APC)** part, turn on the **AUTO PLAY CHORD** button. In this case, when recording begins, press the **START/STOP** button to begin the rhythm.
 - The track for the RHYTHM ([Rhythm]) part can be selected for recording only when STEP RECORD is active.

5. Set the sounds, effects and volume as desired.
 - The settings which are in effect at the time that recording begins are stored at the very beginning of the song.

6. Use the **TEMPO** buttons or **TEMPO/PROGRAM** dial (KN1500) to adjust the recording tempo.
 - The tempo is shown on the display as a numerical value (J=).
 - If you wish to record the tempo setting and tempo changes, select the CONTROL part, or use STEP RECORD: RHYTHM. (Refer to page 71.)

7. Turn the metronome on or off (On/Off) as desired with the **TRANPOSE (PROG)** ^ and v buttons.
 - The metronome sound is not recorded.

8. Play the keyboard.
 - Recording begins.
 - The current measure number is shown as "MEASURE" on the display.
 - You can also press the **START/STOP** button to start the rhythm and begin recording.
 - If the metronome is on, when you press the **START/STOP** button, a two-measure count plays, after which recording automatically begins. In this case, the rhythm does not start.
 - Recording does not start until the two-measure count is completed.
 - The remaining memory is shown on the display as "%".
 - If you wish to adjust the volume balance of each track, the metronome, etc., during recording, press the **BALANCE** button and adjust the volume on the SEQ BALANCE display. Press the **OTHER PARTS/TRACKS** button if you wish to view other tracks, etc.
 - If you wish to redo the recording or change the recording track, press the **EXIT** button. In this case, recording is terminated, so select the recording tracks again. You can change the panel settings at this time, if desired.

9. When you have finished recording, press the **MENU** button in the **SEQUENCER** section to turn it off.
 - When the **MENU** button is turned off, the ending command is recorded. Note that, as long as the ending command is not recorded, blank recording continues even if you stop playing.
 - The display changes to the SEQ PLAY display.

■ **Multi-track recording**

To record the next track immediately after the first track is completed, press the **EXIT** button. The track you just recorded changes to a "PLAY" track. Use the buttons below the display to specify "REC" for the next track you wish to record, and make the various settings (sound, etc.) for the track. Next, press the **START/STOP** button and record the track. The "PLAY" tracks are played back while you record. You can repeat these steps until your multi-track recording is complete.

- For multi-track recording, be sure to press the **START/STOP** button to begin recording.
- If after recording you wish to change the panel setting and store them as the beginning song data, follow the **PANEL WRITE** procedure. (Refer to page 75.)

CYCLE RECORD

This mode allows you to have specified recording measures continuously repeated. Thus you can record measures by adding notes during any cycle.

1. On the REC display, specify "REC" for the track number you are going to record, and "PLAY" for track numbers you wish to have played back.

2. Press the **PAGE** ^ button.
 - The display looks similar to the following.

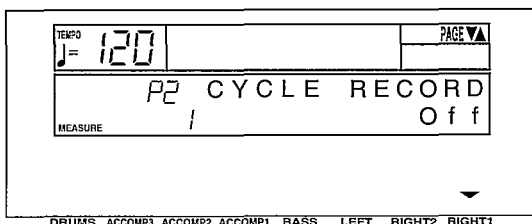

3. Press the **RIGHT 1** ^ button to select "On".
 - The display looks similar to the following.

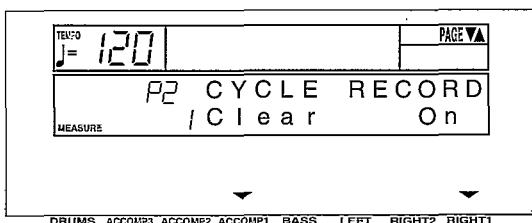

4. Press the **PAGE** ^ button.
 - The display looks similar to the following.

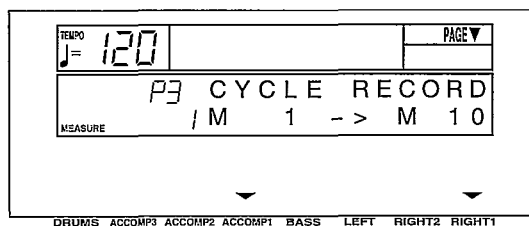

5. Use the **ACCOMP 1** ^ and v buttons to specify the beginning measure number.
6. Use the **RIGHT 1** ^ and v buttons to specify the ending measure number.
 - The ending measure you specify becomes the last measure of the cycle.

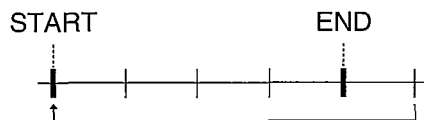

7. Press the **START/STOP** button.
 - Cycle recording of the specified measures begins. If the metronome is on, cycle recording begins after a two-measure count.
 - The rhythm does not start.

(Continued on the next page)

8. Play the keyboard.
 - The specified measures are repeated, during which time you can record by adding notes little by little at the correct timing (over-dubbing).
 - If you wish to erase all the performance data from the specified measures, press either **ACCOMP 1** (Clear) button on the P2 display.
 - The maximum number of notes which can sound simultaneously for a track is 16.
9. When you have finished recording, turn off the **MENU** button in the **SEQUENCER** section.
 - The display changes to the SEQ PLAY display.

Sequencer[®] Play

Play back your recorded performance.

1. Select a song number. (Refer to page 61.)
2. In the **SEQUENCER** section, press the **PLAY** button to turn it on.

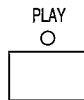

- The display looks similar to the following.

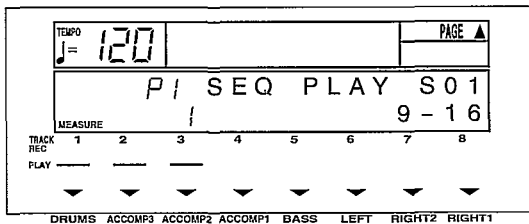

3. Use the buttons below the display to select the track numbers you wish to have played back.
 - In the **PLAY** row, turn on the horizontal bars for the **TRACK** numbers you wish to have played back.
 - You can press the **OTHER PARTS/TRACKS** button to view the display for tracks 9 to 16.
 - On the display for tracks 1–8, a “9–16” indication means that at least one track from tracks 9–16 is selected as a playback track.
 - You can select two or more tracks to play back at one time.
 - The current song number is shown on the display (S01 to S20).

- If necessary, use the **TEMPO** buttons or the **TEMPO/PROGRAM** dial (KN1500) to adjust the playback tempo.
- The tempo is shown on the display as “♩ =”.
- If the tempo was stored in the **CONTROL** or **RHYTHM** part, when that part is played back, the stored tempo data has priority.

4. Press the **SEQUENCER RESET (FILL IN 1)** button.
 - The **SEQUENCER** returns to the beginning of the song and the beginning panel settings are recalled.

5. To begin playback from a measure other than measure 1, use the **PAGE** ^ button to select [P4 SEQ PLAY].
 - The display looks similar to the following.

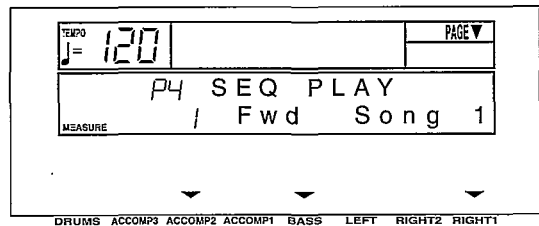

6. Use the **ACCOMP 2** ^ and v buttons to select the beginning playback measure.
 - By pressing and holding either **BASS** (Fwd) button, you can fast-forward to the desired measure while listening to the sound. This button does not function during playback.
 - “MEASURE” indicates the current measure number.

7. Press the **START/STOP** button.
 - The recorded performance is played back from the specified measure.
 - When playback is begun from a measure in which an **INTRO**, **COUNT INTRO**, **FILL IN** or **ENDING** is recorded, the corresponding function does not work.
 - If you wish to adjust the volume balance of each track or each **AUTO PLAY CHORD** part, for example, press the **BALANCE** button and adjust the volume on the SEQ BALANCE display. Press the **OTHER PARTS/TRACKS** button if you wish to view other tracks and parts.
8. To stop playback, press the **START/STOP** button.
 - If the **START/STOP** button is pressed again, playback will continue from the point it was interrupted.

9. When you are finished playing back your performance, press the **PLAY** button in the **SEQUENCER** section to turn it off.
 - During STEP RECORD or EDIT operations, the MEASURE indication on the display conforms to the time signature data recorded in the RHYTHM part.
 - If you wish to play back a different song, use the **RIGHT 1** ^ and v buttons on the P4 display to select a different song number.
 - Even if you press the **EXIT** button, for example, to exit the SEQ PLAY display, as long as the **PLAY** button is on, the song will be played back when the **START/STOP** button is pressed. In this case, even when the normal performance display is shown, the song may be played back without the rhythm start when the **START/STOP** button is pressed. Therefore, be sure to turn off the **PLAY** button if you do not wish to play back the recorded performance.

CYCLE PLAY

You can have specified measures played back repeatedly.

1. On the P1 SEQ PLAY display, specify "PLAY" for track numbers you wish to have played back.
2. Press the **PAGE** ^ button.
 - The display looks similar to the following.

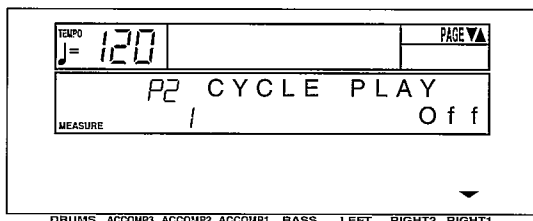

3. Press the **RIGHT 1** ^ button to select On.
4. Press the **PAGE** ^ button.
 - The display looks similar to the following.

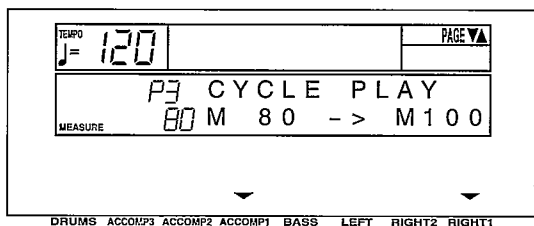

5. Use the **ACCOMP 1** ^ and v buttons to specify the beginning measure number.
6. Use the **RIGHT 1** ^ and v buttons to specify the ending measure number.
 - The ending measure you specify becomes the last measure of the cycle.

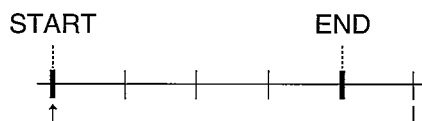

7. Press the **START/STOP** button.
 - Cycle playback of the specified measures begins.
8. To stop cycle playback, press the **START/STOP** button again.
 - During playback stop, if the **SEQUENCER RESET (FILL IN 1)** button is pressed, the **SEQUENCER** returns to the measure number specified in step 5. If the **SEQUENCER RESET** button is pressed again, the **SEQUENCER** returns to measure 1.

Step Record

Store a chord progression

Store the chord progression for the **AUTO PLAY CHORD** in the track for the CHORD part. Then, when the **AUTO PLAY CHORD** is used during playback, even if you do not specify the chords with your left hand, the chords change automatically.

- The chord length is specified with the **STEP RECORD** keys on the keyboard.

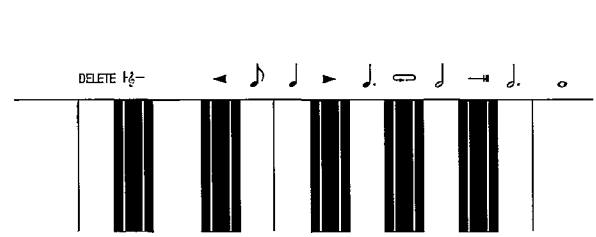

Note value keys

- Whole note
- ◡ Dotted half-note
- ◡ Half-note
- ◡ Dotted quarter-note
- ◡ Quarter-note
- ◡ Eighth-note

Reset key

⏮ Press to begin storing from the beginning.

Correction keys

- ◀ Move back one step.
- ▶ Move forward one step.

Repeat key

↺ Press to end the chord-storing procedure and to specify automatic repeat playback of the stored progression.

End key

→ Press after the whole chord progression has been stored.

DELETE key

DELETE Press to erase data.

- To erase all the data from the current track, while pressing the **DELETE** key, press the End key (→).

■ Example of storing a chord progression

Measure 1	2	3	4
C	C	F G7	C Am
○	○	◡ ◡	◡ ◡

1. Select the song number. (Refer to page 61.)
2. On the **SEQUENCER** menu display, select P1.
 - The display changes to the following.

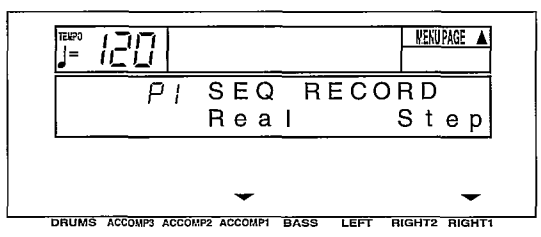

3. Press either **RIGHT 1** (Step) button.
 - The display changes to the following.

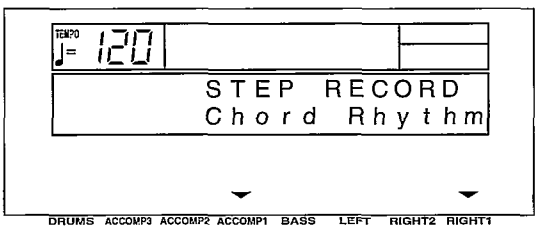

4. Press either **ACCOMP 1** (Chord) button.
 - The display changes to the following.

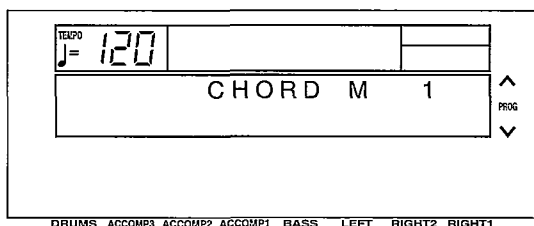

5. Store the chords.

<Measure 1, measure 2>

While playing a C chord with your left hand, press the \circ key one time with your right hand.

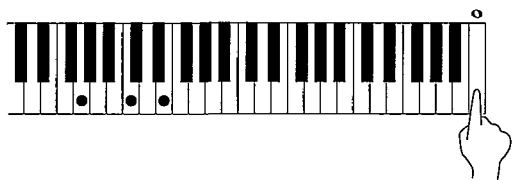

- A “beep” tone indicates that the chord has been successfully stored.
- The chord name is shown on the display.
- The measure automatically advances, in accordance with the specified note value.

<Measure 3>

- (1) While playing an F chord, press the \circ key one time.

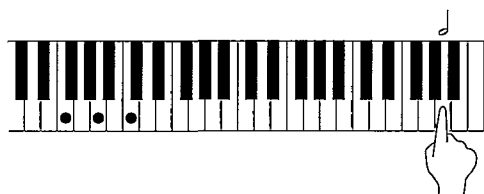

- (2) While playing a G7 chord, press the \circ key one time.

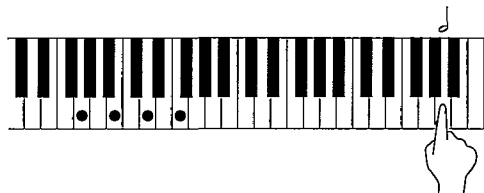

<Measure 4>

- (1) While playing a C chord, press the \circ key one time.

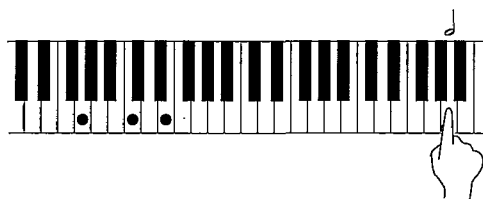

- (2) While playing an Am chord, press the \circ key one time.

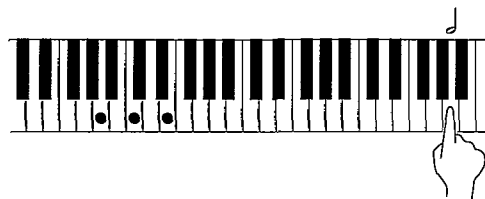

- You can press an **INTRO & ENDING** button or a **FILL IN** button on the panel to store the desired pattern at the current position. (An **INTRO** or **COUNT INTRO** can be stored only at the beginning.)

6. At the end of the chord progression, press the End key (—H).

- This instrument exits the recording mode.
- During playback, playback of the recorded chord progression stops at this point. For automatic repeat playback of the chord progression, press the Repeat key (—) instead of the End key (—H).

- When you play back the track for the Chord part, the chords of the automatic accompaniment change in accordance with the stored chord progression.
- Chords can also be specified in the ONE FINGER mode.
- If the **ON BASS** button is on, chords such as “C on G” can also be specified.

■ Correct the recorded chord progression

1. Follow the procedure to select the STEP RECORD: CHORD display.
2. Use the **TRANPOSE** (PROG) \wedge and \vee buttons to go to the measure you wish to modify. Use the \blacktriangleleft and \blacktriangleright Correction keys to move the point you wish to edit.

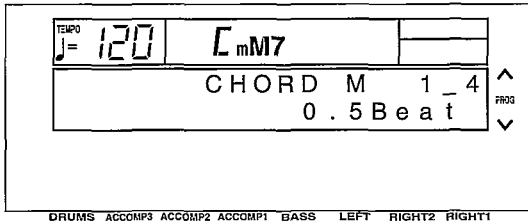

- The measure number is indicated in the upper row. (Example: [1_4] indicates the fourth beat of the first measure.)
- In the lower row, the note length of the specified note is indicated in Beat units.
- To go to the end of the chord progression, while pressing the Reset key (H_4), press the \blacktriangleleft key.

3. Correct the chord data.

Chord data

When the chord name is displayed, you can press the **DELETE** key to erase the data and then store a new chord.

- If you do not erase the displayed data before entering new chord data, the new data is inserted at this point, and the displayed data is merely shifted by the note value of the new chord.

Control data

The name of the stored function (INTRO, FILL, etc.) is displayed. You can press the **DELETE** key to erase the data which is displayed.

■ TRACK CLEAR

To erase all data from the current track, hold down the **DELETE** key and press the End (H) key.

Store a rhythm progression

Changes in the rhythm selection and tempo, as well as the intro, fill-ins and the ending, can be stored by measures with the step recording method.

1. Select the song number. (Refer to page 61.)
2. On the **SEQUENCER** menu display, select P1.
 - The display looks similar to the following.

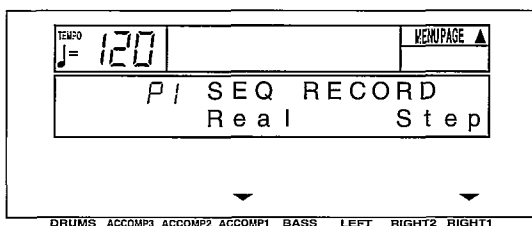

3. Press either **RIGHT 1** (Step) button.
 - The display changes to the following.

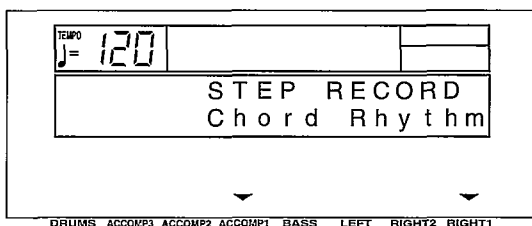

4. Press either **RIGHT 1** (Rhythm) button.
 - The display changes to the following.

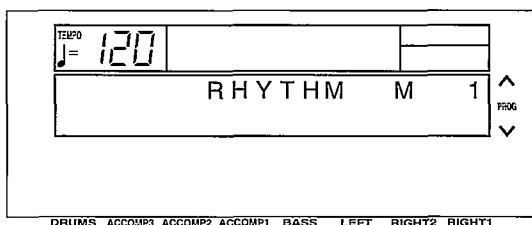

5. Use the **TRANSPOSE** (PROG) ^ and v buttons to go to the measure you wish to record.

6. Store the rhythm data.

- Data which can be stored:
 - START/STOP**
Changes in the rhythm selection
Changes in the **VARIATION** selection
 - COUNT INTRO, INTRO, FILL IN, ENDING**
Tempo changes
- Be sure to store the **START/STOP** data in the measure in which the rhythm starts or stops.
- If you are storing a **COUNT INTRO** or **INTRO**, store this data before the **START/STOP** data.

7. Repeat steps 5 and 6 to continue storing the rhythm progression.

8. At the end of the rhythm progression, press the End key.

- If the Repeat key is pressed instead of the End key, during playback the recorded rhythm progression is repeated.
- This instrument exits the recording mode.

■ Correct the recorded rhythm progression

1. Follow the procedure to select the **STEP RECORD: RHYTHM** display.
2. Use the **TRANSPOSE** (PROG) ^ and v buttons or the ◀ and ▶ Correction keys to move the point you wish to edit.

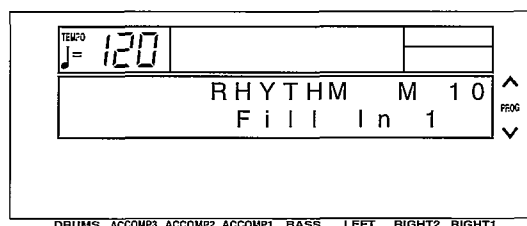

3. Correct the rhythm data.
 - Press the **DELETE** key to erase data.
 - If you select a rhythm with a different time signature, the time signature of all subsequent measures will also change.
 - If data has already been recorded in other tracks, you cannot select a rhythm with a different time signature.

■ TRACK CLEAR

To erase all data from the current track, while the **RHYTHM** display is shown, hold down the **DELETE** key and press the End (—H) key.

Track Assign

Each **SEQUENCER** part is already assigned to a track number. However, you can use the **TRACK ASSIGN** function to assign parts to tracks as you wish. This function is also used to designate the tracks used for the rhythm data and chord progression data.

1. Select the song number. (Refer to page 61.)
2. On the **SEQUENCER** menu display, select P2.
 - The display looks similar to the following.

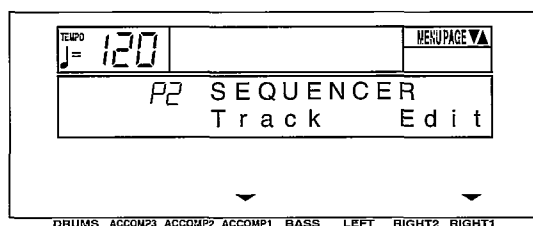

3. Press either **ACCOMP 1** (Track) button.
 - The display changes to the following.

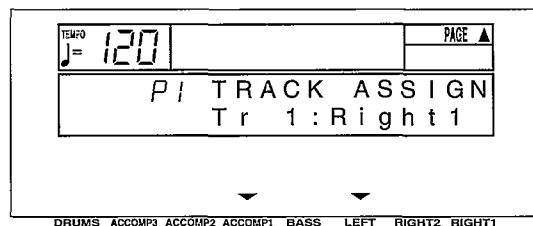

4. Use the **ACCOMP 1** ^ and v buttons to select the track.
5. Use the **LEFT** ^ and v buttons to select the part for the specified track.
 - Select one of the following parts: [Right1], [Right2], [Left], [Part4] to [Part15], [Drum], [APC], [Chord], [Control], [Rhythm]. (For an explanation of each **SEQUENCER** part, refer to page 63.)
 - When a part other than the [Control], [APC/Chord] or [Rhythm] part is assigned, the track assign procedure is completed at this point.
 - The [Rhythm], [Control] and [APC/Chord] parts cannot be assigned to more than one track.
6. When assigning the [Control], [APC/Chord] or [Rhythm] part, press either **RIGHT 1** button.
 - The **ARE YOU SURE?** display appears. Press either **LEFT** (Yes) button to execute the function. Or press either **RIGHT 1** (No) button if you wish to cancel the procedure.

■ TRACK ASSIGN PRESETS

A preset track assignment can be selected.

1. While the P1 **TRACK ASSIGN** display is shown, press the **PAGE** ^ button.
 - The display looks similar to the following.

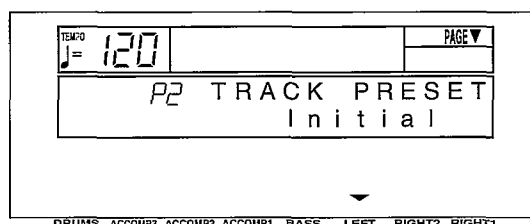

2. Use the **LEFT** ^ and v buttons to select the track assign mode.
 - Select from the following modes.

Initial: Factory-preset settings.

Tech Multi: The optimum track assignment for a 16-part multi-timbre sound generator.

GM Multi: The optimum track assignment for creating GENERAL MIDI data.

3. Press the **EXECUTE (SYNCHRO & BREAK)** button.
 - The **ARE YOU SURE?** display appears. Press either **LEFT** (Yes) button to execute the function. Or press either **RIGHT 1** (No) button if you wish to cancel the procedure.
 - If [Yes] was selected, "COMPLETED!" is shown on the display and the selected track assign mode is enabled.
 - After the **TRACK PRESET** is executed, you can use the **ACCOMP 1** ^ and v buttons to check the track assignment.

Editing the recorded performance

The edit feature allows you to erase or change portions of your performance after it has been recorded.

Select the edit function

1. Select the number of the song you wish to edit. (Refer to page 61.)
2. On the **SEQUENCER** menu display, select P2.
 - The display changes to the following.

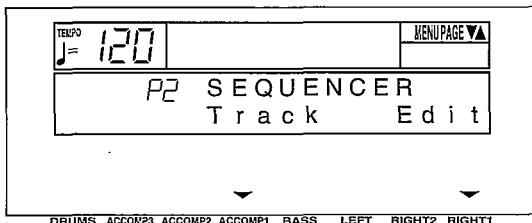

3. Press either **RIGHT 1** (Edit) button.
 - The display changes to the following SEQ EDIT menu display.

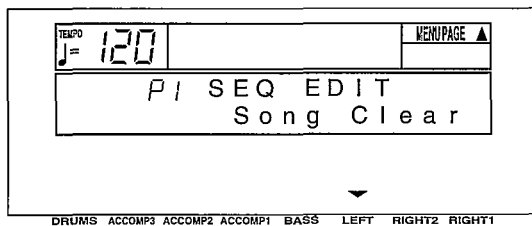

4. Use the **PAGE** \wedge and \vee buttons to select a menu item.

P1: [Song Clear]
 P2: [Track Clear]
 P3: [Quantize]
 P4: [Song Copy]
 P5: [Panel Write]

5. Press either **LEFT** button.
 - The display changes in accordance with your selection.
6. Perform the editing procedures.
 - During the editing procedure, you can press the **EXIT** button to go back to the SEQ EDIT menu display.

SONG CLEAR

Erase the recorded contents of a specified song.

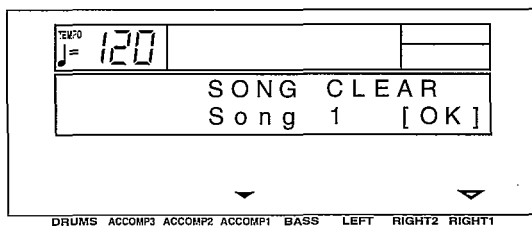

1. Use the **ACCOMP 1** \wedge and \vee buttons to specify the number of the song to erase.
 - If [All] is selected, all the songs recorded in the **SEQUENCER** will be erased.

2. Press either **RIGHT 1** (OK) button.
 - The ARE YOU SURE? display appears. Press either **LEFT** (Yes) button to execute the function. Or press either **RIGHT 1** (No) button if you wish to cancel the procedure.
 - If [Yes] was selected, "COMPLETED!" appears on the display, the specified songs are erased, and the instrument returns to the normal performance mode.

TRACK CLEAR

Erase the contents of a specific track.

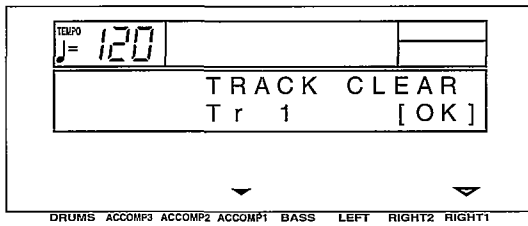

1. Use the **ACCOMP 1** ^ and v buttons to select the track you wish to clear.
 - If [All] is selected, the data is erased from all the tracks.

2. Press either **RIGHT 1** (OK) button.
 - The ARE YOU SURE? display appears. Press either **LEFT** (Yes) button to execute the function. Or press either **RIGHT 1** (No) button if you wish to cancel the procedure.
 - If [Yes] was selected, "COMPLETED!" appears on the display, and the specified tracks are erased.
3. To erase more than one track, repeat steps 1 and 2.

QUANTIZE

The QUANTIZE function can correct the timing of your performance after it has been recorded. If the rhythm is slightly out of sync or inexact, it will automatically be corrected to the specified quantize level.

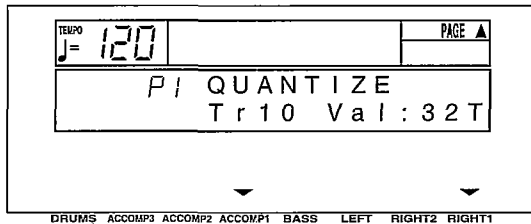

Rhythm as written in the score



Timing of actual performance

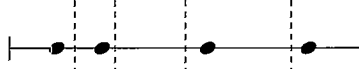

Quantized performance



1. Use the **ACCOMP 1** ^ and v buttons to specify the track number.
 - You cannot quantize the track for the [Control], [Rhythm] or [APC/Chord] part.
 - If [All] is selected, all the tracks are quantized.

2. Use the **RIGHT 1** ^ and v buttons to specify the quantize level.
 - This setting specifies the timing (minimum note value) on which the quantizing will be based.
 - Select from 4, 8, 16, 32, 8T, 16T, 32T. (Example: 16=sixteenth note; T=triplet-type note.)

3. Press the **PAGE** ^ button.
 - The display changes to the following.

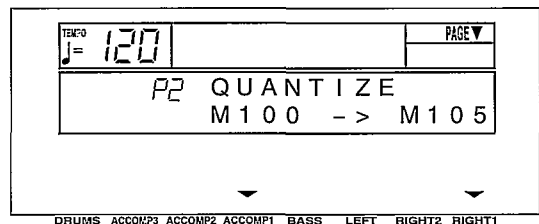

4. Use the **ACCOMP 1** ^ and v buttons to specify the start point (measure number).
5. Use the **RIGHT 1** ^ and v buttons to specify the end point (measure number).
6. Press the **EXECUTE (SYNCHRO & BREAK)** button.
 - The ARE YOU SURE? display appears. Press either **LEFT** (Yes) button to execute the function. Or press either **RIGHT 1** (No) button if you wish to cancel the procedure.

SONG COPY

Copy the recorded data from specific tracks of a song.

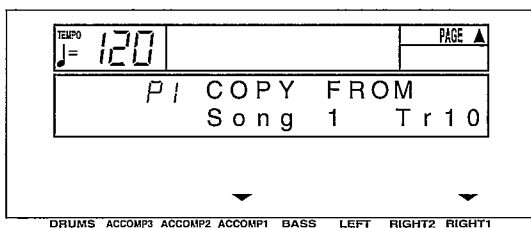

1. Use the **ACCOMP 1** ^ and v buttons to specify the song number to copy from.
2. Use the **RIGHT 1** ^ and v buttons to specify the number of the track to copy from.
 - If [All] is selected, all the tracks of the specified song number will be copied.

3. Press the **PAGE** ^ button.
 - The display changes to the following.

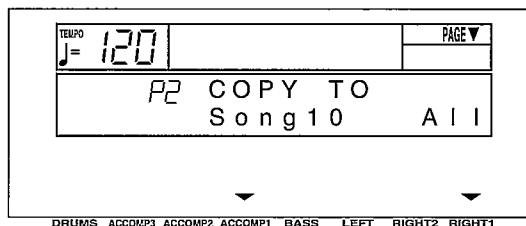

4. Use the **ACCOMP 1** ^ and v buttons to specify the song number to copy to.
5. Use the **RIGHT 1** ^ and v buttons to specify the number of the track to copy to.
 - If [All] is selected, the data will be copied to all the tracks of the specified song number.
6. Press the **EXECUTE (SYNCHRO & BREAK)** button.
 - The ARE YOU SURE? display appears. Press either **LEFT** (Yes) button to execute the function. Or press either **RIGHT 1** (No) button if you wish to cancel the procedure.

PANEL WRITE

You can change the panel status which is in effect at the beginning of the song. These are the settings which are recalled when the **SEQUENCER RESET** button is pressed.

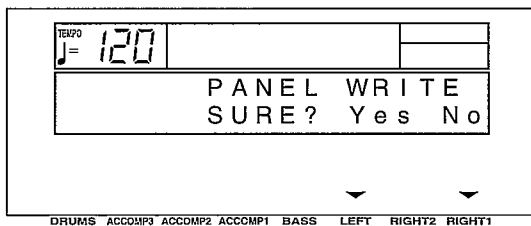

1. Use the panel buttons to change to the desired panel settings.
2. Press either **LEFT** (Yes) button.
 - To cancel the procedure, press either **RIGHT 1** (No) button.
 - If the [Yes] button is pressed, "COMPLETED!" is shown on the display.
 - PANEL WRITE is automatically activated at the beginning of the REALTIME RECORD, or when a panel setting is changed during recording standby.

Sequencer Medley

You can have the songs played back continuously in order. Songs saved on a disk can also be played back in a medley.

1. On the **SEQUENCER** menu display, select **P3 SEQ PLAY**.
 - The display looks similar to the following.

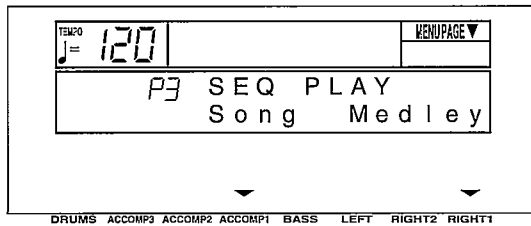

2. Press either **RIGHT 1** (Medley) button.
 - **KN920/KN1500**: The display looks similar to the following.

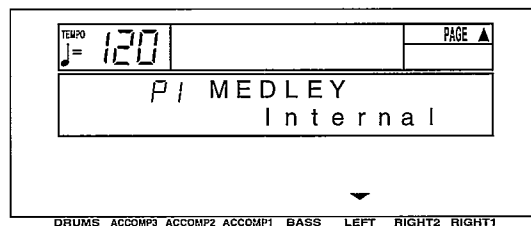

- **KN720**: Skip to step 5.
3. **KN920/KN1500**: Use the **LEFT** ^ and v buttons to specify which songs you wish to have played.

Internal: Play back song data from this instrument's **SEQUENCER** memories.
 FD Technics: Play back Technics format song data saved on the floppy disk in the disk drive.
 Other FD: Play back Standard MIDI File (Format 0) and DISK ORCHESTRA COLLECTION™ (DOC) song data saved on the floppy disk in the disk drive.

- Note that if [FD Technics] is selected and medley play is executed, all song data (SONG 1-10) currently stored in the **SEQUENCER** memory is destroyed.

4. Press the **PAGE** ^ button.
 - The display looks similar to the following.

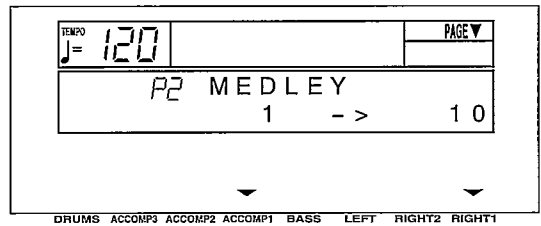

(KN920/KN1500)

5. Use the **ACCOMP 1** ^ and v buttons to specify the first song you wish to have played.
6. Use the **RIGHT 1** ^ and v buttons to specify the last song.
7. Press the **START/STOP** button.
 - The songs are played back in the specified order.
 - The display looks similar to the following.

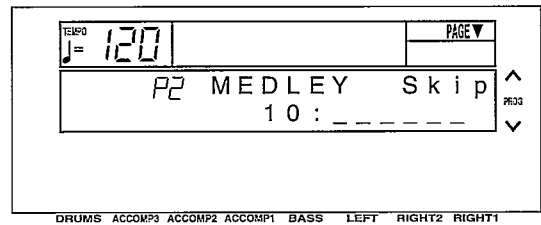

- You can press either **TRANSPOSE** (PROG) button to skip to the next song.
8. To stop medley play, press the **START/STOP** button.
 - **KN920/KN1500**: Features and operation of the Disk Drive are explained in "Part VII Disk Drive" (page 89).

Part V Composer (KN920/KN1500)

Outline of the Composer

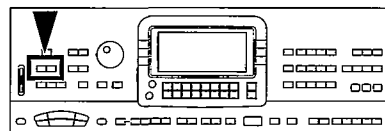

The **COMPOSER** enables you to create your own accompaniment patterns or to edit preset accompaniment patterns. A pattern is comprised of five parts: **DRUMS**, **BASS** and three **ACCOMP** parts. These parts would form the backing of a song, for example: Drums, Acoustic Bass, Piano, Jazz Guitar and Vibes. You may find it useful at first to copy and edit a preset pattern.

Rhythm components which can be stored

You can store up to 12 different rhythms (4 in each memory bank **A**, **B**, **C**).

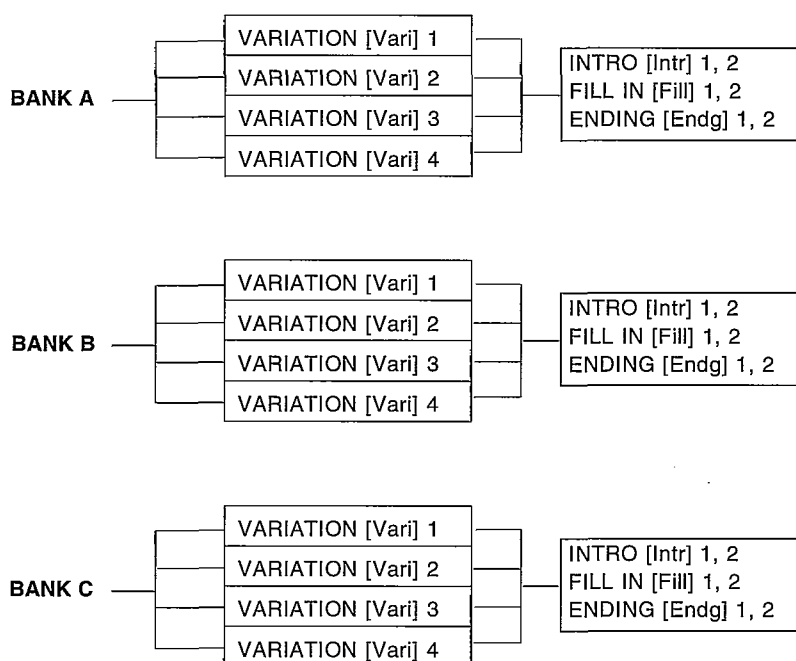

- You can also create **INTRO**, **FILL IN** and **ENDING** patterns for each bank (**A**, **B**, **C**). These patterns are played back when the **COMPOSER MODE** is set to [Expand]. (Refer to page 83.)

Memory capacity

Expressed in terms of notes, the total number of notes which can be stored in all the **COMPOSER** memories is about 10,000. The remaining memory available for recording is shown on the **RECORD** display as a percentage (**MEMORY= %**).

- When "MEMORY FULL!" appears on the display no more data can be stored in the **COMPOSER**.
- The recorded **COMPOSER** data can be saved to a disk and later quickly recalled (**COMPOSER LOAD**). (Refer to page 92.)

COMPOSER RECORD menu

When you press the **RECORD** button in the **COMPOSER** section to turn it on, the display changes to the following.

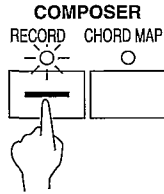

- Use the **PAGE** buttons to view the three pages of menu display.

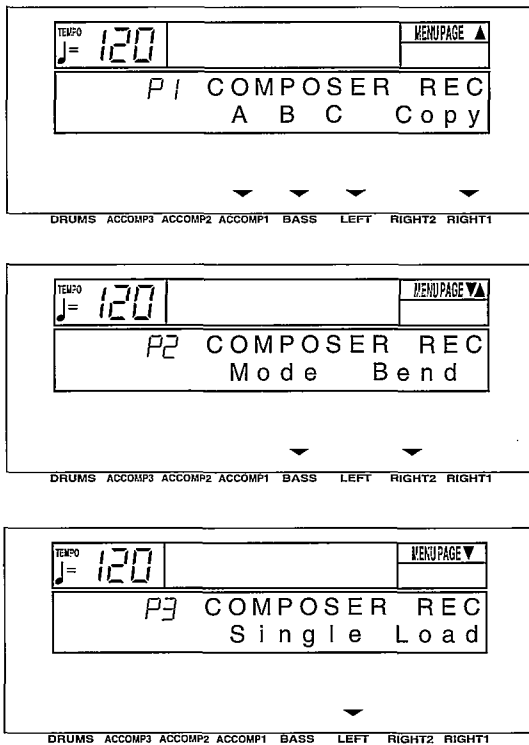

Summary of the COMPOSER menu items

[P1 COMPOSER REC]

A/B/C (pages 79 and 80)

Create a pattern in each of the A, B, C banks.

Copy (page 79)

Copy a preset rhythm pattern into a memory.

[P2 COMPOSER REC]

Mode (page 83)

Specify whether or not you are playing back your own **INTRO**, **FILL IN** and **ENDING** patterns.

Bend (page 84)

Set the pitch range for when the **PITCH BEND** wheel is operated during recording of the **ACCOMP** and **BASS** parts.

[P3 COMPOSER REC]

Single Load

Recall the desired **COMPOSER** data from data saved on a disk. The items on this menu are also on the **MEMORY & CONTROL** menu, and the procedures are the same (page 93).

Two ways to record in the COMPOSER

There are two ways to create and record a rhythm.

■ Edit a preset rhythm (pages 79 and 82)

Use the copy function to copy a preset rhythm to a memory, change parts of it, and then store it as a new rhythm.

■ Create a completely new rhythm (pages 80 and 82)

Clear the memories and compose a completely new rhythm from scratch.

Edit a preset rhythm pattern: preparation

These are step-by-step instructions for preparing to create a new rhythm pattern by modifying a part of a preset rhythm pattern. First you copy one of the preset rhythm patterns to a location in the specified memory bank.

1. On the **COMPOSER RECORD** menu display, select P1.
 - The display looks similar to the following.

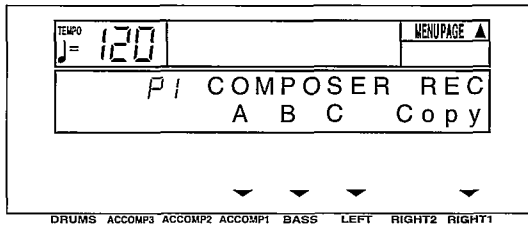

2. Press either **RIGHT 1** (Copy) button.
 - The display looks similar to the following.

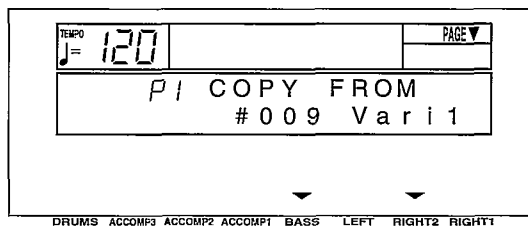

3. Use the **BASS** ^ and v buttons to select a rhythm number to copy.
4. Use the **RIGHT 2** ^ and v buttons to select the name of the section to copy from.
 - Select from Vari (VARIATION) 1–4, Intr (INTRO) 1, 2, Endg (ENDING) 1, 2, V (VARIATION) 1FI (FILL IN) 1, 2, V2FI 1, 2, V3FI 1, 2, V4FI 1, 2.

5. Press the **PAGE** ^ button.
 - The display looks similar to the following.

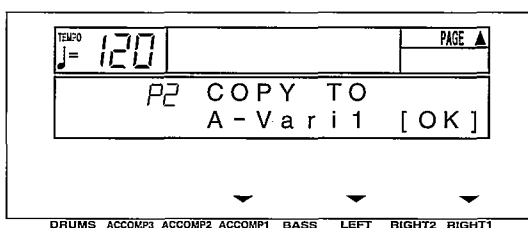

6. Use the **ACCOMP 1** ^ and v buttons to select a memory bank to copy to (A, B, C).

7. Use the **LEFT** ^ and v buttons to select the section name to copy to.

- Select from Vari 1–4, Intr 1, 2, Fill 1, 2, Endg 1, 2.

8. Press either **RIGHT 1** (OK) button.

- When copying has been successfully completed, "COPY COMPLETED!" appears on the display.

9. Press the **EXIT** button to view the P1 display.

10. Select the bank to which you copied the rhythm pattern (the memory bank you selected in step 6: A, B or C).

- The display looks similar to the following.

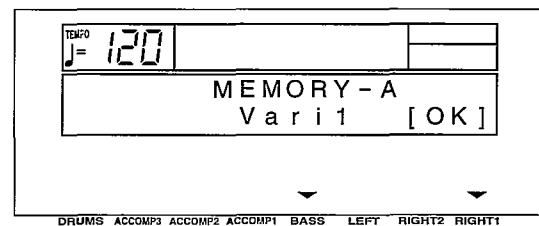

11. Use the **BASS** ^ and v buttons to select the section name to which you copied the section (the section name you selected in step 7).

12. Press either **RIGHT 1** (OK) button.

- The display looks similar to the following.

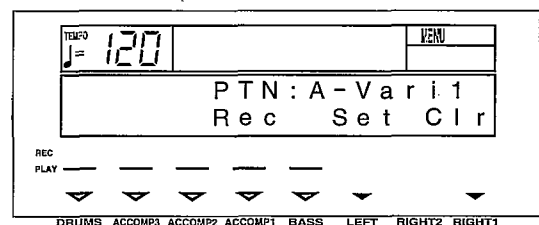

(Continued on the next page)

- If you wish to name your new rhythm pattern (except for FILL IN, INTRO and ENDING), press either **LEFT** (Set) button.
 - If you do not input a name for your rhythm pattern, the name becomes the same as the original rhythm from which you copied. Skip to step 17.
 - The display looks similar to the following.

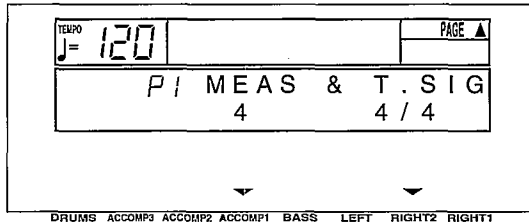

- Press the **PAGE** ▲ button to view the P2 PAT-TERN NAME display.
 - The display looks similar to the following.

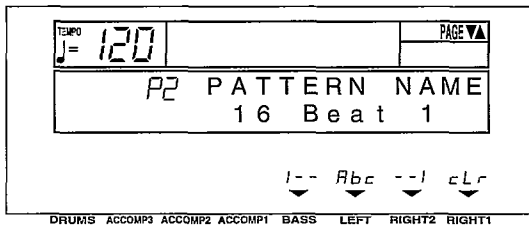

- Type a new name for your rhythm pattern (up to 12 characters).
 - Use the **BASS** or the **RIGHT 2** buttons to highlight the character position. Use the **LEFT** (Abc) ^ and v buttons to select the alpha-numeric character. Repeat these steps to type the whole name.
 - To erase all the characters, press either **RIGHT 1** (cLr) button.

- Press the **EXIT** button to return to the following display.

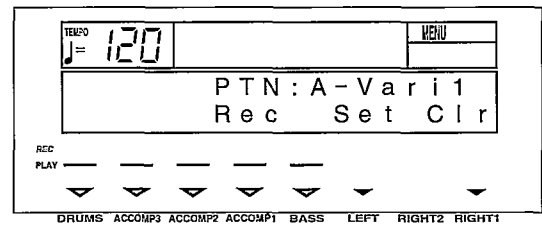

- Press a [Rec] button to select the rhythm part you want to record first.

- BASS**
- ACCOMP 1**
- ACCOMP 2**
- ACCOMP 3**
- DRUMS**

- The pattern you copied and the metronome sound start, and recording begins. (Refer to page 82.)

Create a completely new rhythm: preparation

Here are the preparatory steps to compose a completely new rhythm from scratch.

- On the **COMPOSER RECORD** menu display, select P1.
 - The display looks similar to the following.

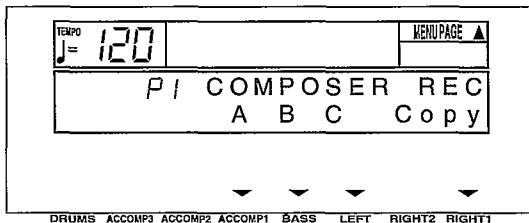

- Select a bank in which to record the rhythm (A, B or C).
 - The display looks similar to the following.

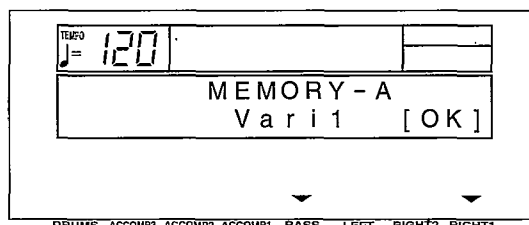

- Use the **BASS** ^ and v buttons to specify the section you are going to create.
 - Select from Vari 1-4, Intr 1, 2, Fill 1, 2, Endg 1, 2.

- Press either **RIGHT 1** (OK) button.
 - The display looks similar to the following.

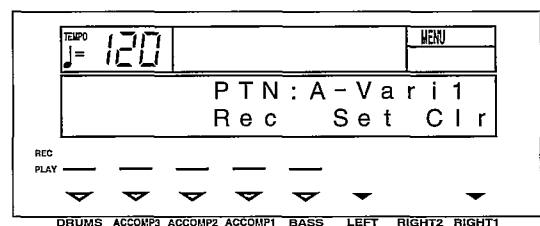

5. Press either **RIGHT 1** (Clr) button.
 - The following confirmation display appears. Press either **LEFT** (Yes) button to execute the function, or press either **RIGHT 1** (No) button to cancel the function.

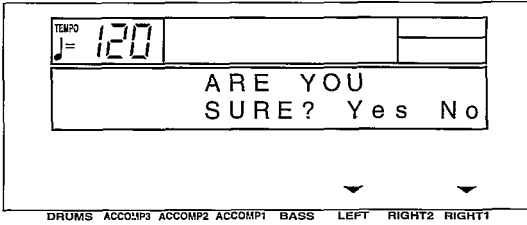

- If [Yes] was selected, "COMPLETED!" appears on the display, and the contents of all parts are cleared.

6. Press either **LEFT** (Set) button.
 - The display looks similar to the following.

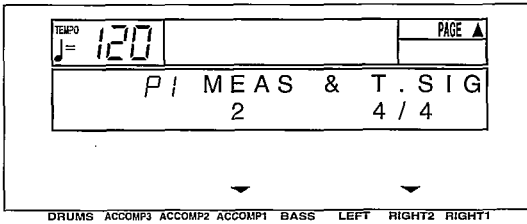

7. Use the **ACCOMP 1** ^ and v buttons to specify the number of measures in your repeating rhythm pattern (1 to 8).
8. Use the **RIGHT 2** ^ and v buttons to specify the time signature (1/4 to 8/4).
 - The settings for the number of measures and the time signature can be changed only if all the parts of the pattern were cleared in step 5.

9. Press the **PAGE** ^ button to view the P2 PATTERN NAME display (except for FILL IN, INTRO and ENDING).
 - The display looks similar to the following.

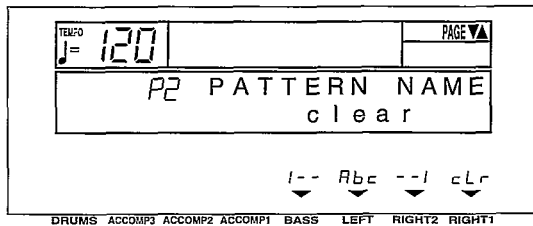

10. Type a name for your rhythm pattern (up to 12 characters).
 - Use the **BASS** or **RIGHT 2** ^ and v buttons to highlight the character position. Use the **LEFT** (Abc) ^ and v buttons to select the alphanumeric character. Repeat these steps to type the whole name.
 - To erase all the characters, press either **RIGHT 1** (cLr) button.

11. If you wish to record a performance in a key other than C major, or if you wish to specify the type of chord progression, press the **PAGE** ^ button to view the P3 CHORD SET 1 display.
 - The display looks similar to the following.

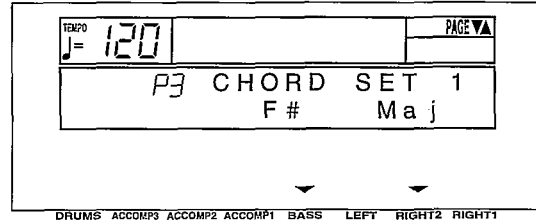

- If you do not wish to change these settings, skip to step 17.

12. Use the **BASS** ^ and v buttons to specify the root note of the chords you wish to record. Use the **RIGHT 2** ^ and v buttons to specify the type of chord you wish to record (Min or Maj).

13. Press the **PAGE** ^ button to view the P4 CHORD SET 2 display.
 - The display looks similar to the following.

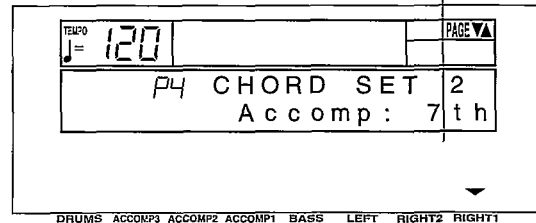

14. Use the **RIGHT 1** ^ and v buttons to specify the type of phrase progression for the **ACCOMP** parts (Normal [Nrm], or 7th).

15. Press the **PAGE** ^ button to view the P5 CHORD SET 3 display.
 - The display looks similar to the following.

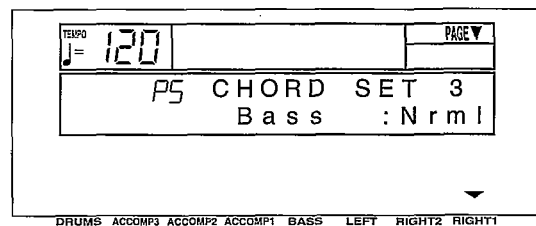

16. Use the **RIGHT 1** ^ and v buttons to specify the type of phrase progression for the **BASS** part (Normal [Nrm], or 7th).

(Continued on the next page)

17. Press the **EXIT** button to return to the following display.

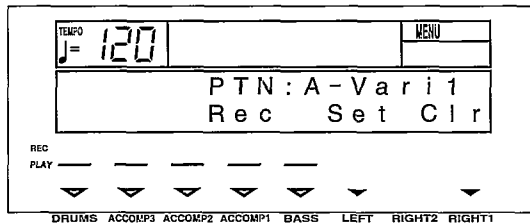

18. Press a [Rec] button to select the rhythm part you want to record first.

BASS
ACCOMP 1
ACCOMP 2
ACCOMP 3
DRUMS

- The metronome sound starts and recording begins.

Record your rhythm pattern

Store each part of the rhythm pattern as you perform it on the keyboard.

Recording procedure

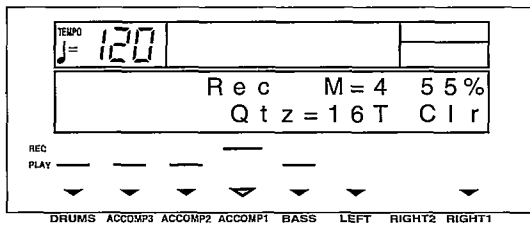

1. Adjust the tempo.

- The tempo can be freely adjusted when you play back the rhythm pattern, so record at the tempo which is easiest for you to play.

2. Select the sound.

- For the **DRUMS** part, select sounds from the **KEYBOARD PERC** sounds.
- For the **ACCOMP 1** to **3** and the **BASS** parts, select sounds from groups other than the **KEYBOARD PERC** sounds. You can also set the **DIGITAL EFFECT** to on or off.
- Depending on the selected sound, the sound quality may differ from that during a normal performance.

3. Record the part.



- The specified number of measures are repeatedly played back, during which time any newly played notes are added to those already recorded. The current measure number is shown on the display as "M=".
- Record the performance in C major for correct chord progressions during playback. To record the performance in a different scale, refer to page 81.
- The **PITCH BEND** wheel operation and **SUSTAIN** on/off are also recorded (except for the **DRUMS** part).

4. When you have finished recording one part, use the [Rec] buttons below the display to select the next part to record.

- The ▼ mark for the selected part only flashes.

5. Repeat steps 1 through 4 to record all the parts of the rhythm.

6. When you have finished recording the rhythm, press the **RECORD** button in the **COMPOSER** section to turn it off.

■ Functions during recording

Clr

Press either **RIGHT 1** (Clr) button if you wish to erase all recorded contents of the currently selected part.

INST ERASE

When the **DRUMS** part is selected, the **DRUMS** part can be cleared instrument by instrument. Hold down the **INST ERASE (SPLIT POINT)** button and specify the instrument sound to be deleted by pressing the corresponding instrument key on the keyboard, after which only the specified instrument will be erased for as long as this button is kept pressed.

Qtz (QUANTIZE)

Set the desired quantize level to smooth out any unevenness in the timing of your performance. Use the **LEFT** ^ and v buttons to specify the timing (minimum note value) on which the quantizing will be based.

- Select from 32T, 32, 16T, OFF, 16, 8T, 8, 4. (Example: 16=sixteenth note; T=triplet-type note.)

Playback

1. Press the **COMPOSER** button to turn it on.

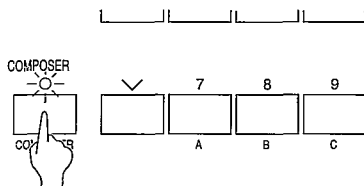

2. Use the number pad to select the bank.

- Press **7** for bank **A**, **8** for bank **B**, or **9** for bank **C**.

3. Use the **VARIATION & MSA** buttons to select the variation (1 to 4).

4. Press the **START/STOP** button.

- The **DRUMS** part begins to play back.
- The **BASS** and **ACCOMP** parts are played back when you use the **AUTO PLAY CHORD**.

Composer mode

Two playback modes are available for you to choose from. If you wish to use the intro, fill-in and ending patterns from a preset rhythm when you play back your new rhythm pattern, select **NORMAL MODE**. For creating and playing back your original intro, fill-in and ending patterns, select **EXPAND MODE**.

1. On the **COMPOSER RECORD** menu display, select **P2**.
 - The display changes to the following.

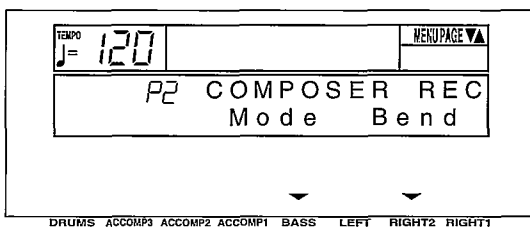

2. Press either **BASS** (Mode) button.

- The display looks similar to the following.

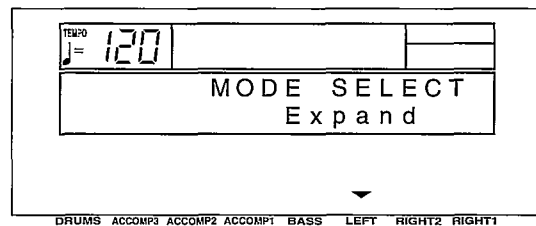

3. Use the **LEFT** ^ and v buttons to select the mode.

■ Normal

When a **FILL IN** button or the **INTRO & ENDING** button is pressed during playback, the corresponding pattern for a preset rhythm is played back.

■ Expand

When a **FILL IN** button or an **INTRO & ENDING** button is pressed during playback, the corresponding pattern you created is played back.

- Only one each **FILL IN 1**, **FILL IN 2**, **INTRO 1**, **INTRO 2**, **ENDING 1** and **ENDING 2** pattern can be created for each of the three banks (**A**, **B** or **C**). The fill-in patterns, etc. for each bank are used for all the basic rhythms in the same bank.
- Each pattern of a bank should have the same time signature.

<BANK A>

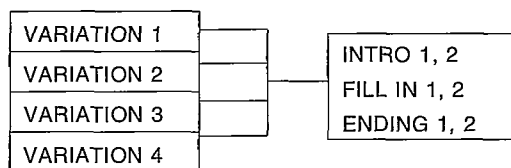

<BANK B>

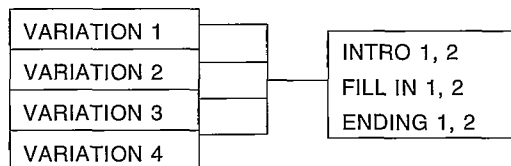

<BANK C>

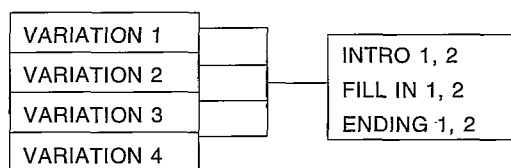

Bend Range

Adjust the amount of pitch change applied to the **ACCOMP** parts and the **BASS** part when the **PITCH BEND** wheel is operated during **COMPOSER** recording.

1. On the **COMPOSER RECORD** menu display, select P2.
- The display looks similar to the following.

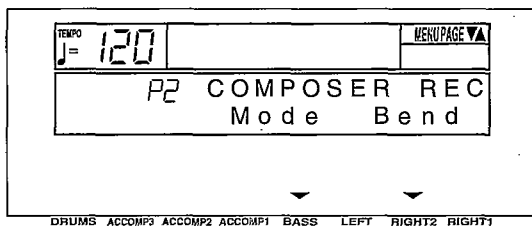

2. Press either **RIGHT 2** (Bend) button.
- The display looks similar to the following.

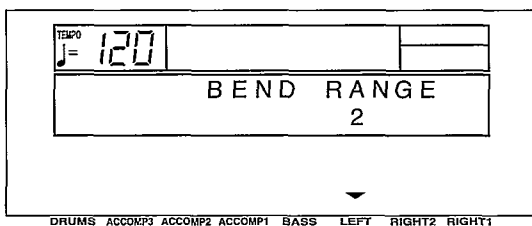

3. Use the **LEFT** ^ and v buttons to specify the range (0 to 12).
- Increments are in semitones.

Composer Chord Map

A different accompaniment pattern can be selected for each of the four types of chords (major, minor, seventh and diminished). Then the accompaniment combination can be stored in one of five different maps.

- Store beforehand in a **COMPOSER** memory (Vari 1–4) each accompaniment pattern you are going to perform when a type of chord is selected. When recording a pattern, for the minor type for example, record it in a minor key.

1. Press and hold the **CHORD MAP** button in the **COMPOSER** section for a few seconds.

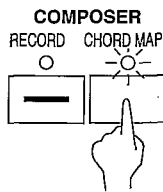

- The display looks similar to the following.

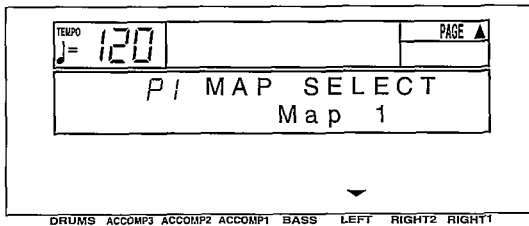

2. Use the **LEFT** ^ and v buttons to select a map number (Map 1 to 5).

3. Press the **PAGE** ^ button.

- The display looks similar to the following.

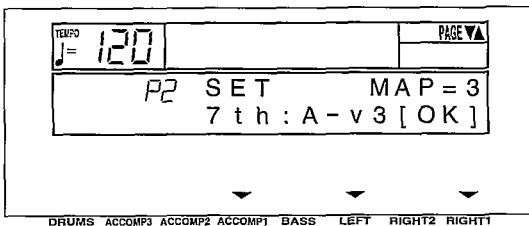

4. Use the **ACCOMP 1** buttons to select a chord type.

- Select from [Maj] (major), [Min] (minor), [7th], and [Dim] (diminished).

5. Use the **LEFT** ^ and v buttons to select a pattern for the chord type (bank name–variation number).

- The accompaniment pattern for the **INTRO**, **FILL IN** and **ENDING** is the one selected for [Maj].
- The accompaniment pattern for chords which are set to [Off] is the same as the pattern for [Maj] chords.

6. Repeat steps 4 and 5 for each chord type, as desired.

- Only patterns with the same number of measures and same time signature can be selected.

7. When all the settings are completed, press either **RIGHT 1** (OK) button.

- “COMPLETED!” appears on the display, and the settings are executed.

8. Press the **PAGE** ^ button.

- The display looks similar to the following.

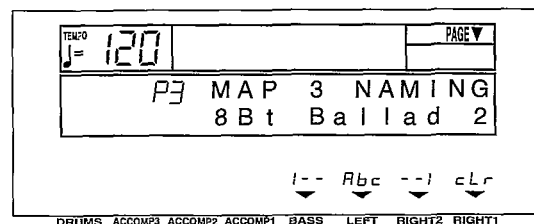

9. Assign a name to the map.

- Use the **BASS** or **RIGHT 2** buttons to highlight the character position. Use the **LEFT** (Abc) ^ and v buttons to select the alphanumeric character. Repeat these steps to type the whole name.

- To erase all the characters, press either **RIGHT 1** (cLr) button.

10. Use the **PAGE** buttons to select P1 MAP SELECT. Repeat steps 3 to 9 to create other maps, as desired.

11. When you have finished making the map settings, press the **EXIT** button.

Recall chord map

Follow the procedure below to recall a stored chord map and use with your performance.

1. Press the **CHORD MAP** button in the **COMPOSER** section to turn it on.
2. Use the number pad to select the number of the desired map (1 to 5).
 - The selected map number and map name are shown on the display.
3. Play the keyboard using the automatic accompaniment.
 - The pattern changes according to the type of chord you play.
 - If you select a different rhythm or **COMPOSER** rhythm, the **COMPOSER CHORD MAP** function is canceled.



Part VI Song memory (KN720)

Store your performance

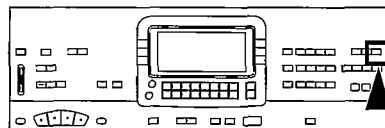

The stored contents of the **SEQUENCER** can be saved in this instrument's memory (**SAVE**).

- The stored contents of the **PANEL MEMORY** and the current panel settings are also stored.

SAVE

1. Press the **MEMORY & CONTROL** button to turn it on.

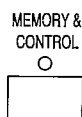

- The display looks similar to the following.

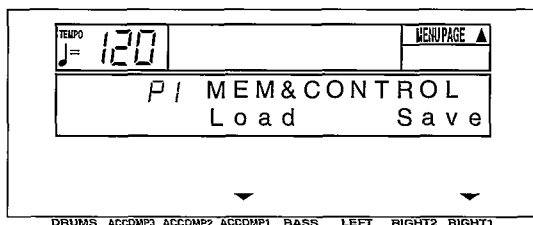

2. Press either **RIGHT 1** (Save) button.
- The display looks similar to the following.

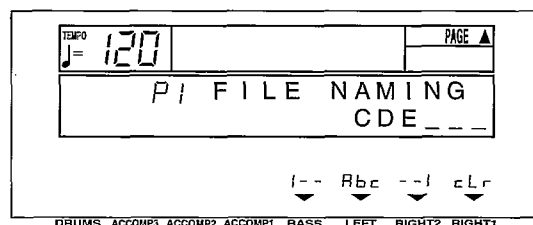

3. Assign a name to the song (up to 6 characters).
- Use the **BASS** and **RIGHT 2** buttons to highlight the character position. Use the **LEFT** (Abc) buttons to select the alphanumeric character. Repeat these steps to type the whole name.
 - To erase the name, press either **RIGHT 1** (cLr) button.

4. Press the **EXECUTE (SYNCHRO & BREAK)** button.

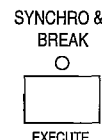

- The display looks similar to the following.

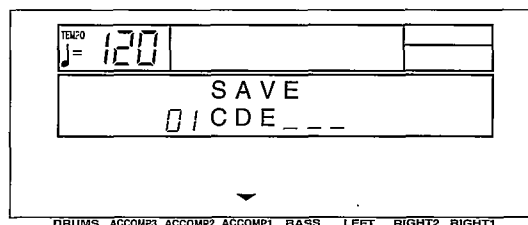

5. Use the **ACCOMP 1** ^ and v buttons to select the file number to save.
- File numbers in which songs are already saved are indicated by the song name.
 - The number of files that can be saved is limited. If you are saving several songs which use a lot of memory, the number of files which can be saved will be about three.
 - When the internal memory is full, "FILE FULL!" is shown on the display. Use the **FILE DELETE** function (refer to the next article) to clear any unnecessary files.
6. Press the **EXECUTE (SYNCHRO & BREAK)** button.
- The **SAVE** operation begins.
 - When the operation has been successfully completed, "COMPLETED!" is shown on the display.
 - If you attempt to save data to a file number in which data is currently saved, the display changes to the confirmation display. Press either **LEFT** (Yes) to continue the save procedure, or press either **RIGHT 1** (No) button if you wish to cancel the procedure.



FILE delete

Use the following procedure to clear a specific file.

1. On the FILE NAMING display, press the **PAGE** ^ button.

- The display looks similar to the following.

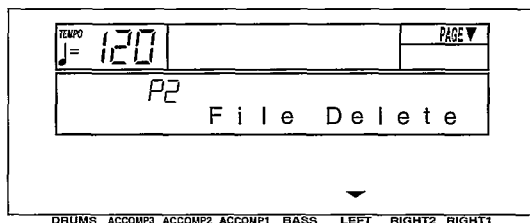

2. Press either **LEFT** button.

- The display looks similar to the following.

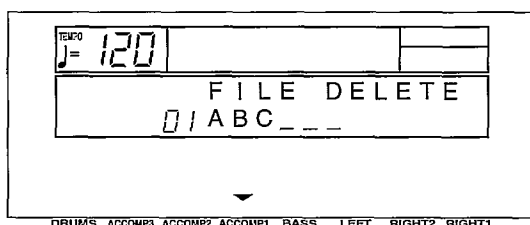

3. Use the **ACCOMP 1** ^ and v buttons to specify the file to erase.

4. Press the **EXECUTE (SYNCHRO & BREAK)** button.

- The ARE YOU SURE? display appears. Press either **LEFT** (Yes) button to execute the function. Or press either **RIGHT 1** (No) button if you wish to cancel the procedure.

- The contents of the song files are preserved even if the **PLAY** button is turned off, as long as power is being supplied through the AC adaptor or the batteries.

Recall the stored performance

The contents of the song files can be recalled any time (LOAD).

- When the LOAD procedure is performed, the current memory contents (**SEQUENCER, PANEL MEMORY, etc.**) are replaced by the contents of the selected song file.

LOAD

1. Press the **MEMORY & CONTROL** button to turn it on.

- The display looks similar to the following.

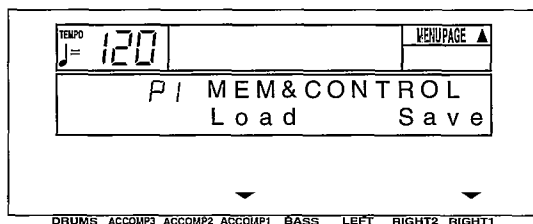

2. Press either **ACCOMP 1** (Load) button.

- The display looks similar to the following.

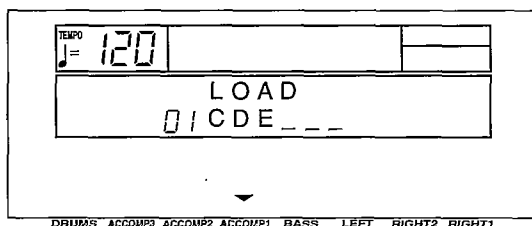

3. Use the **ACCOMP 1** ^ and v buttons to select the file number to load.

- File numbers and the names of stored songs are shown on the display.

4. Press the **EXECUTE (SYNCHRO & BREAK)** button.

- The LOAD operation begins.
- When the operation has been successfully completed, "COMPLETED!" is shown on the display.

1. Press the MEMORY & CONTROL button to turn it on. The display looks similar to the following.

Part VII Disk Drive (KN920/KN1500)

Outline of the Disk Drive function

The Disk Drive enables you to store **COMPOSER** memories, **SEQUENCER** data etc. for future use.

Internal memory and Floppy Disk Drive

The storable internal memory is fixed at a limited capacity, but this external memory device expands the storable memory infinitely.

- You can use 3.5 inch 2DD (720 KB) or 2HD (1.44 MB) floppy disks; however, 2HD disks formatted as 2DD cannot be used.
- Specific file formats are handled as follows.

		SAVE	LOAD
TECHNICS File		○	○
Standard MIDI File	FORMAT 0	○	○
	FORMAT 1	×	○

FORMAT 0: There is one track on the disk, and it contains the 16 MIDI channels.

FORMAT 1: There is an unlimited number of tracks on the disk, each of which can contain the 16 MIDI channels.

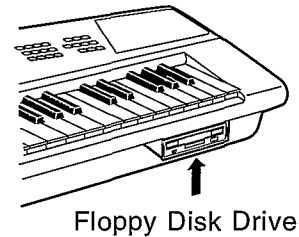

Floppy Disk Drive

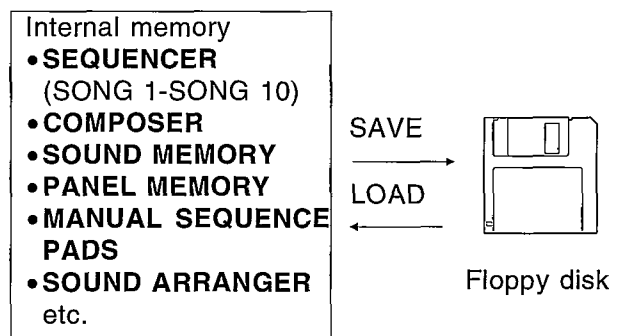

Load commercial software

Disks recorded using the Disk Drive of this instrument can, of course, be played back on your instrument (TECHNICS file). But this instrument also reads song data from floppy disks recorded in the Standard MIDI File format, enabling you to play commercial song disks on this instrument. In addition, by saving this instrument's **SEQUENCER** data in the Standard MIDI File format, you can play it back on an external sequencer.

DIRECT PLAY

You can play commercially sold song disks immediately without performing the normal load procedure.

- **DIRECT PLAY** can be used for the following disks:
Standard MIDI File (SMF) disks (FORMAT 0)
DISK ORCHESTRA COLLECTION™ (DOC)

■ About Standard MIDI Files

“Standard MIDI File” is a standardized data format which makes it possible for music data to be exchanged among different sequencers. Data stored in this format on sequencers of different models can be played back on this instrument, and vice versa.

- Only files with the “.MID” extension can be loaded.
- No more than 310 KB of data can be loaded into this instrument.

Warning

Standard MIDI Files ensure the compatibility of data such as key on, key off, velocity, program number. It does not guarantee 100% faithful reproduction of recorded music which is replete with such data. For exact playback of music, it may be necessary to perform extensive adjustments of all the sound generator settings. As you the listener are the ultimate judge of what sounds best, you should perform such adjustments to your satisfaction.

Main parts of the Floppy Disk Drive

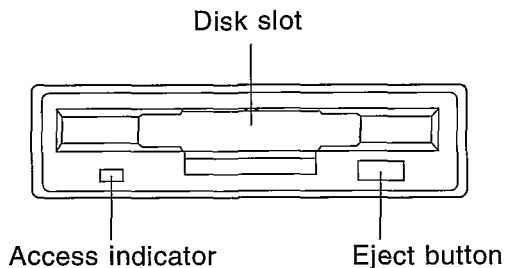

Eject button

Press to remove the disk from the Disk Drive.

Access indicator

Lights when data is being loaded from or saved to disk.

- To prevent data loss, do not remove the disk from the Disk Drive or turn off the power when the access indicator is lit.

Outline of procedure

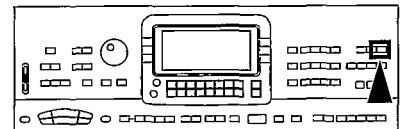

1. Press the **MEMORY & CONTROL** button to turn it on.

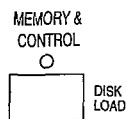

3. Select the desired menu and follow the procedures on the corresponding setting display.

4. When you have finished setting the functions, press the **MEMORY & CONTROL** button to turn it off.

2. Use the **PAGE** buttons to select the desired menu.

- There are six pages of the menu display.

P1 Load (page 91)

Load data in either the Technics File format or Standard MIDI File format from a disk into this instrument's memory.

P1 Save (page 97)

Save data from this instrument's memory to a disk, in either the Technics File format or the Standard MIDI File format.

P2 Direct Play (page 95)

Immediate playback of commercial song disks.

P3 FD Format (page 96)

Format new floppy disks or erase the contents of recorded disks so they can be used by this instrument.

- [P4 Initial] is explained on page 122.
- [P5 Foot Switch] is explained on page 58.
- [P6 Contrast] is explained on page 34.

Loading data

Recall (load) the data from the disk to this instrument's memories.

WARNING: The load procedure causes any data which is currently stored in the relevant memories to be erased.

DISK LOAD

1. Insert the disk with the stored data into the Disk Drive. Push it all the way in until you hear a click.

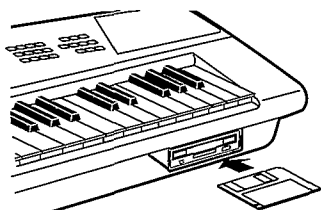

2. On the **MEMORY & CONTROL** menu display, select P1.
 - The display looks similar to the following.

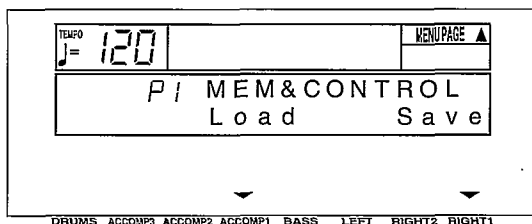

3. Press either **ACCOMP 1** (Load) button.
 - The display changes to the following load menu display.
 - There are three pages of the menu display.

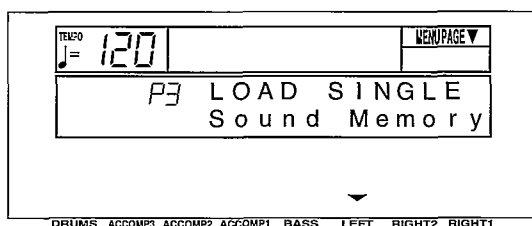
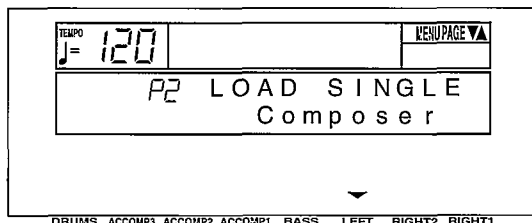
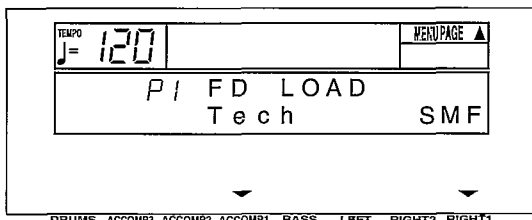

4. Select the type of data load you want.

[Tech]: Load data which was saved in the Technics File format (TECHNICS LOAD).

[SMF]: Load data which was saved in the Standard MIDI File format (SMF LOAD).

[LOAD SINGLE Composer]: Load **COMPOSER** data from a disk into a specified memory number.

[LOAD SINGLE Sound Memory]: Load specified **SOUND MEMORY** data.

5. Perform the selected disk load procedure. (Refer to the following sections.)



■ TECHNICS LOAD

Load data which was saved in the Technics File format.

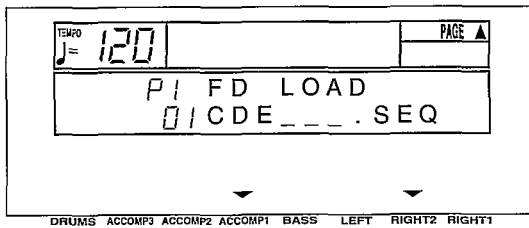

1. Use the **ACCOMP 1** ^ and v buttons to select the file on the floppy disk you wish to load (copy) to this instrument's memories.
 - The file name is shown next to each file number.
2. Use the **RIGHT 2** ^ and v buttons to specify the kind of data you wish to load from the disk to your instrument.

ALL: All the following data is loaded.
 SEQ: Only **SEQUENCER** data
 CMP: Only **COMPOSER** data
 SND: Only **SOUND MEMORY** data
 PNL: Only **PANEL MEMORY** data
 MSP: Only **MANUAL SEQUENCE PADS** data

- The option which was specified during the SAVE procedure is automatically selected. Skip this step if you do not wish to change the selection.
3. For a SEQ file, press the **PAGE** ^ button.
 - The display looks similar to the following.

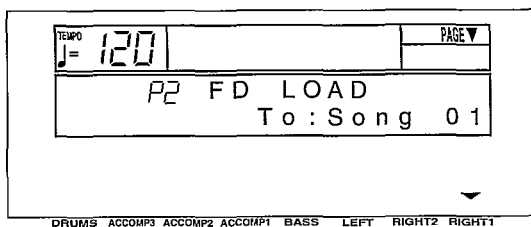

- Use the **RIGHT 1** ^ and v buttons to select the song number in this instrument's memories to which you wish to have the file loaded (copied).
- If you are loading a file that was saved with the ALL option selected, this display will not appear even if SEQ is selected in step 2.
- **SEQUENCER** data is loaded one song at a time. However, if you load a file for which ALL was selected, **SEQUENCER** songs 1 to 10 are loaded at once.

4. Press the **EXECUTE (SYNCHRO & BREAK)** button.

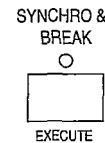

- The LOAD operation begins.
- When the operation has been successfully completed, "COMPLETED!" is shown on the display.
- If song data was loaded, you can press the **START/STOP** button to begin playback when the **PLAY** button of the **SEQUENCER** is on.

- You can quickly load just the **COMPOSER** data by pressing and holding the **COMPOSER LOAD (COMPOSER)** button for a few seconds.
- You can also access the FD LOAD display by pressing the **MEMORY & CONTROL (DISK LOAD)** button for a few seconds.

© 1985 Technics Co., Ltd. All rights reserved.

■ **SMF LOAD**

Load data which was saved in the Standard MIDI File (SMF) format.

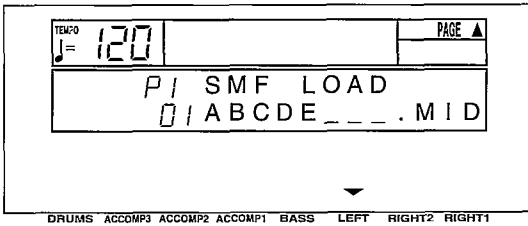

1. Use the **LEFT** \wedge and \vee buttons to select the file.
2. Press the **PAGE** \wedge button.
 - The display looks similar to the following.

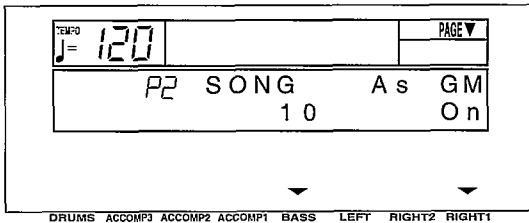

3. Use the **BASS** \wedge and \vee buttons to select the song.
 - Data is loaded one song at a time.
4. Use the **RIGHT 1** \wedge and \vee buttons to specify whether or not to load the song as GENERAL MIDI (GM) (On/Off).
 - If the GM setting you specify is different from the setting in the file, the sounds, the octave, and the arrangement of percussion sounds on the keyboard will be different.
 - Information about GENERAL MIDI can be found on page 112.
 - If playback is executed with the setting set to On, the functions of this instrument are limited in various ways. For detailed information, please refer to the separate REFERENCE GUIDE provided.
5. Press the **EXECUTE (SYNCHRO & BREAK)** button.

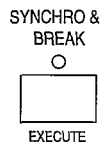

- The LOAD operation begins.
- When the operation has been successfully completed, "COMPLETED!" is shown on the display.
- Press the **START/STOP** button to begin playback.

■ **LOAD SINGLE COMPOSER**

Load the desired **COMPOSER** data from a disk into a specific **COMPOSER** memory.

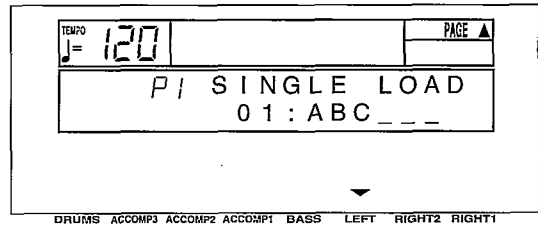

1. Use the **LEFT** \wedge and \vee buttons to select the number of the file with the data you wish to load.
2. Press the **PAGE** \wedge button.
 - The display looks similar to the following.

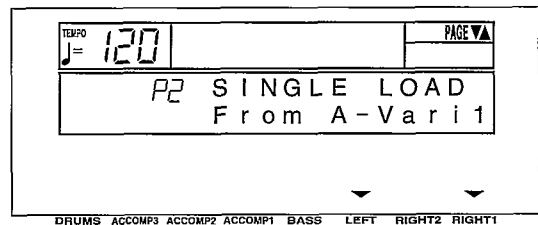

3. Select the pattern you wish to load.
 - Use the **LEFT** \wedge and \vee buttons to specify the bank name, and the **RIGHT 1** \wedge and \vee buttons to specify the section name.
4. Press the **PAGE** \wedge button.
 - The display looks similar to the following.

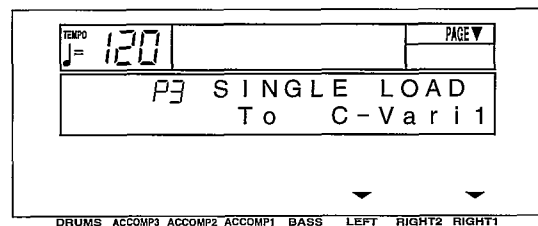

5. Select the section to load to.
 - Use the **LEFT** \wedge and \vee buttons to specify the bank name, and the **RIGHT 1** \wedge and \vee buttons to specify the section name.
6. Press the **EXECUTE (SYNCHRO & BREAK)** button.
 - The LOAD operation begins.
 - When the operation has been successfully completed, "COMPLETED!" is shown on the display.
 - This procedure can also be accessed from the **COMPOSER** menu display. (Refer to page 78.)

■ **LOAD SINGLE SOUND MEMORY**

Load the desired **SOUND** data from a disk into a specific **SOUND MEMORY**.

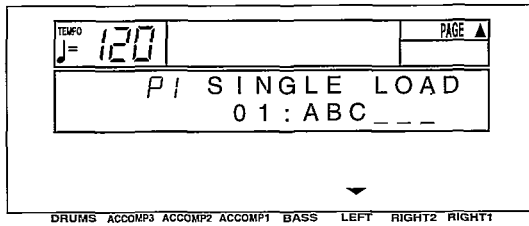

1. Use the **LEFT** ^ and v buttons to select the number of the file with the data you wish to load.
2. Press the **PAGE** ^ button.
 - The display looks similar to the following.

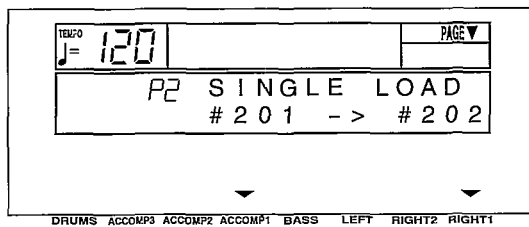

3. Use the **ACCOMP 1** ^ and v buttons to select the sound number (201–240) you wish to load.
4. Use the **RIGHT 1** ^ and v buttons to specify the sound number to load to.
5. Press the **EXECUTE (SYNCHRO & BREAK)** button.
 - The **LOAD** operation begins.
 - When the operation has been successfully completed, "COMPLETED!" is shown on the display.



Playing commercial disks

Commercial song disks can be played back directly from a disk. The usual LOAD operation is not necessary, so playback is quicker.

DIRECT PLAY

1. Insert the disk you wish to play back into the Disk Drive.

2. On the **MEMORY & CONTROL** menu display, select [P2 Direct Play].

- The display looks similar to the following.

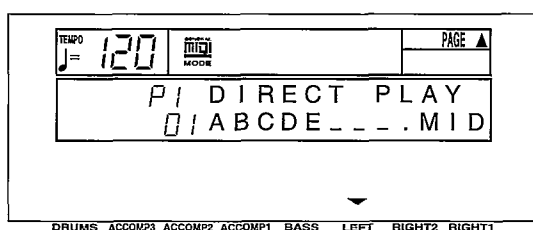

3. Use the **LEFT** ^ and v buttons to select the filename to play back.

4. For SMF files, press the **PAGE** ▲ button.

- The display looks similar to the following.

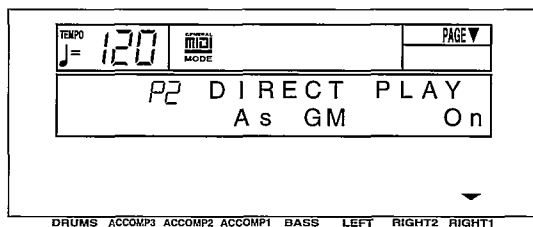

- Use the **RIGHT 1** ^ and v buttons to specify whether or not to play the song as GENERAL MIDI (GM) (On/Off).

- If the GM setting you specify is different from the setting in the file, the sounds, the octave, and the arrangement of percussion sounds on the keyboard will be different.

- Information about GENERAL MIDI can be found on page 112.

- If playback is executed with the setting set to On, the functions of this instrument are limited in various ways. For detailed information, please refer to the separate REFERENCE GUIDE provided.

5. Press the **START/STOP** button.

- The selected song begins to play.
- Press the **START/STOP** button if you wish to stop playback before it has finished.

- You can use the same procedure to play back other songs on the disk.

- The song stops if you exit this display during playback.

- DIRECT PLAY can be used for the following disks:

Standard MIDI File (SMF) disks (FORMAT 0)
DISK ORCHESTRA COLLECTION™ (DOC)

- Standard MIDI File FORMAT 1 disks cannot be played back using DIRECT PLAY. Use SMF LOAD for these disks.



Formatting a disk

New floppy disks can be used only after they have been formatted. Follow the procedure below to format a new disk or erase the contents of a recorded disk.

FLOPPY DISK FORMAT

- This procedure clears the entire contents of the disk.
- Reformat a disk if it cannot be saved to or loaded from properly because of exposure to a magnetic field.
- You can use 3.5 inch 2DD (720KB) or 2HD (1.44MB) floppy disks.
- Be sure to specify the type of format which is suitable for the disk.
- How to distinguish the two disk types:

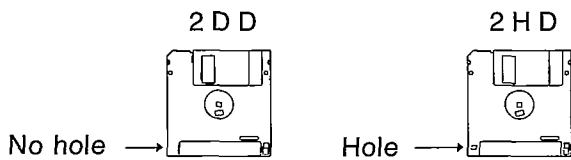

- Although 2HD floppy disks can hold more data and are convenient for quick loading and saving, 2DD disks are generally used for musical instruments. Therefore, you may not be able to use your 2HD disk data with other musical instrument models.
- To format the floppy disk, the write-protect window must be closed, as illustrated.

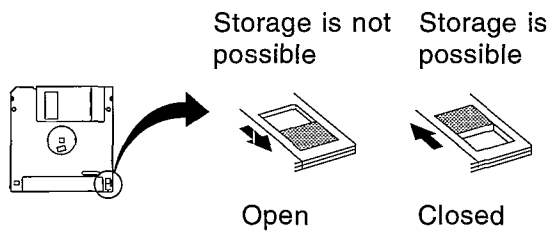

1. Insert the floppy disk into the Disk Drive slot. Push it all the way in until you hear a click.
2. On the **MEMORY & CONTROL** menu display, select [P3 FD Format] and press either **LEFT** button.
- The display changes to the following.

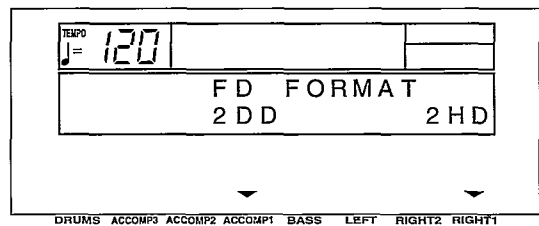

3. Select the type of format (2DD or 2HD).
- Be sure to select the type which is the same as your disk type.
- The display changes to the following.

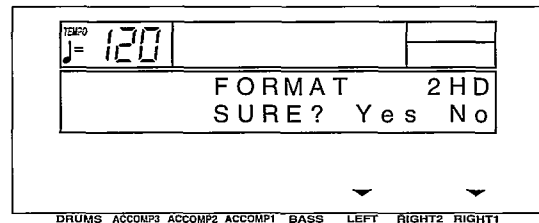

4. Press either **LEFT** (Yes) button to format the disk, or press either **RIGHT 1** (No) button to cancel the format.
- After about 1–2 minutes, formatting is completed, "COMPLETED!" is shown on the display, and this instrument returns to the normal performance mode.

Saving data

The recorded data and panel settings of this instrument can be saved on a disk.

- It is a good idea to save Technics File format data and Standard MIDI File format data in separate disks.

DISK SAVE

This procedure is used to save the performance data and settings of this instrument to a disk.

1. Insert a formatted disk into the Disk Drive slot.
Push it all the way in until you hear a click.
2. On the **MEMORY & CONTROL** menu display, select P1.

- The display looks similar to the following.

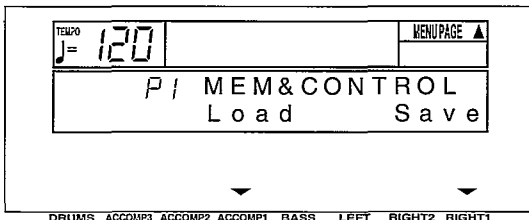

3. Press either **RIGHT 1** (Save) button.
- The display looks similar to the following.

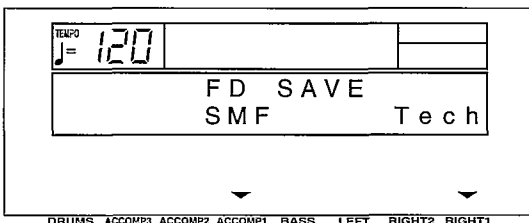

4. Select the type of data save you want.

[Tech]: Save data in the Technics File format (TECHNICS SAVE).

[SMF]: Save data in the Standard MIDI File format (SMF SAVE).

5. Perform the selected disk save procedure. (Refer to the following sections.)

TECHNICS SAVE

Save data from this instrument in the Technics File format to a floppy disk.

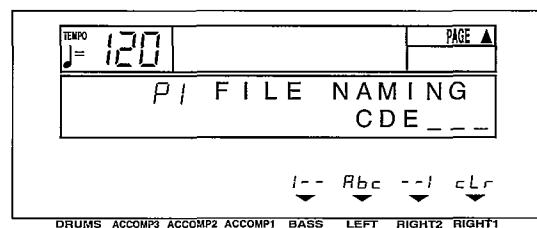

1. Type a name for the new data file (up to 6 characters).

- Use the **BASS** and **RIGHT 2** ^ and v buttons to highlight the character position. Use the **LEFT** (Abc) ^ and v buttons to select the alphanumeric character. Repeat these steps to type the whole name.
- To erase the name, press either **RIGHT 1** (cLr) button.

2. Press the **EXECUTE (SYNCHRO & BREAK)** button.

- The display looks similar to the following.

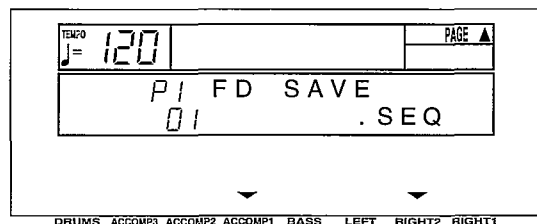

3. Use the **ACCOMP 1** ^ and v buttons to select a file number (01 to 20).

- Files in which data is currently stored are indicated by the file name following the file number.
- The maximum number of files which can be saved may be less than 20 if you are saving many songs which use a lot of memory.
- More data can be saved using 2HD floppy disk.

(Continued on the next page)

4. Use the **RIGHT 2** \wedge and \vee buttons to specify the kind of data you wish to save to the disk.

ALL: All the following data is saved.
 SEQ: Only **SEQUENCER** data
 CMP: Only **COMPOSER** data
 SND: Only **SOUND MEMORY** data
 PNL: Only **PANEL MEMORY** data
 MSP: Only **MANUAL SEQUENCE PADS** data

- The MASTER TUNING setting is not saved.
5. If SEQ was selected in step 4, press the **PAGE** \wedge button.
- The display looks similar to the following.

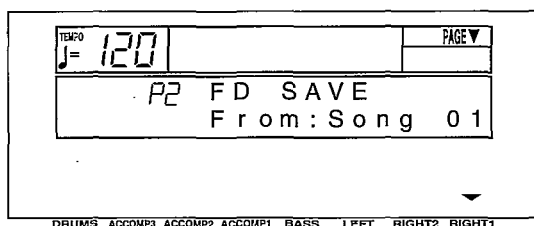

- Use the **RIGHT 1** \wedge and \vee buttons to select the song number in this instrument's memories you wish to have saved to the floppy disk.
 - SEQUENCER** data is saved one song at a time. However, if ALL is selected, the contents of **SEQUENCER** songs 1 to 10 are saved at once. In this case, you can conserve memory by deleting songs you do not wish to save.
6. Press the **EXECUTE (SYNCHRO & BREAK)** button.
- The SAVE operation begins.
 - When the operation has been successfully completed, "COMPLETED!" is shown on the display, and this instrument returns to the normal performance mode.
 - If you attempt to save data to a file number in which data is currently saved, the display changes to the confirmation display. Press either **RIGHT 1** (No) button if you wish to cancel the procedure. When either **LEFT** (Yes) button is pressed, the DISK SAVE operation begins.

FILE delete

Use the following procedure to clear a specific file.

- On the FILE NAMING display, press the **PAGE** \wedge button.
- The display looks similar to the following.

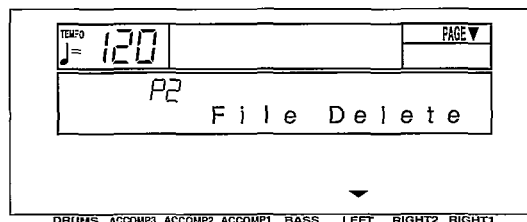

- Press either **LEFT** button.
- The display looks similar to the following.

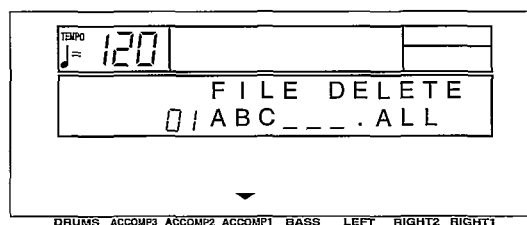

- Use the **ACCOMP 1** \wedge and \vee buttons to specify the file to erase.
- Press the **EXECUTE (SYNCHRO & BREAK)** button.
- The **ARE YOU SURE?** display appears. Press either **LEFT** (Yes) button to execute the function. Or press either **RIGHT 1** (No) button if you wish to cancel the procedure.

■ SMF SAVE

The data from this instrument's **SEQUENCER** can be saved to a floppy disk as Standard MIDI Files (SMF) (FORMAT 0 only). (Standard MIDI Files are most commonly saved on 2DD floppy disks.) Data saved on this instrument can then be used on another instrument.

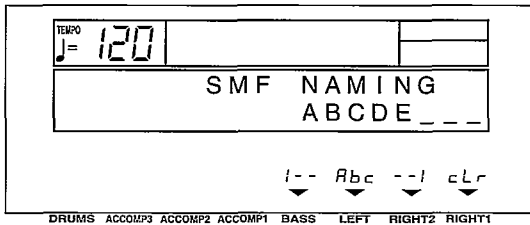

- What you can save in the Standard MIDI File format is ordinary performance data, such as note data. Data such as **SEQUENCER** data for the chord and rhythm parts, **COMPOSER** data, **PANEL MEMORY** data, etc. is not saved. If you wish to also save the special Technics data, first use the TECHNICS SAVE procedure to save the data to a disk, and then follow the SMF SAVE procedure below.
- Standard MIDI Files are generally saved in the GM mode, but can be saved in the Technics mode.

1. Type a name for the new data file (up to 8 characters).
 - Use the **BASS** and **RIGHT 2** \wedge and \vee buttons to highlight the character position. Use the **LEFT** (Abc) \wedge and \vee buttons to select the alphanumeric character. Repeat these steps to type the whole name.
 - To erase the name, press either **RIGHT 1** (cLr) button.
 - Avoid using the numbers from 01 to 20 as the first two letters of the name.
2. Press the **EXECUTE (SYNCHRO & BREAK)** button.
 - The display looks similar to the following.

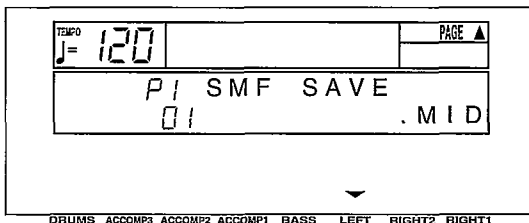

3. Use the **LEFT** \wedge and \vee buttons to select the name of the file in which to save the data.
 - To save in a new file, select a blank line.

4. Press the **PAGE** \wedge button.
 - The display looks similar to the following.

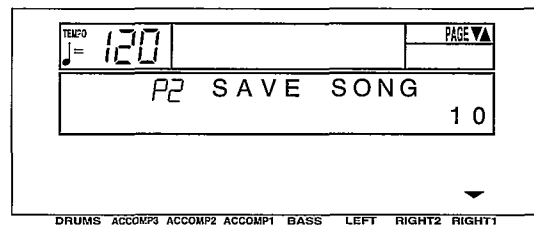

5. Use the **RIGHT 1** \wedge and \vee buttons to select the song number in this instrument's memories you wish to have saved to the floppy disk.
 - Data is saved one song at a time.
6. Press the **PAGE** \wedge button.
 - The display looks similar to the following.

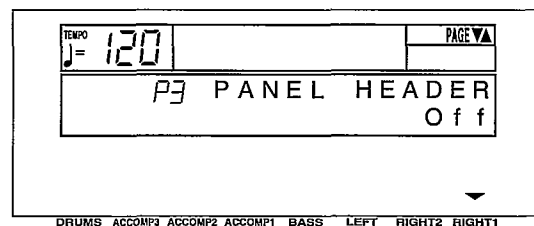

7. Use the **RIGHT 1** \wedge and \vee buttons to select **HEADER On/Off**.
 - Select On to save the sound, volume and other settings for each part as data at the beginning of the file.

(Continued on the next page)

8. Press the **PAGE** ^ button.
 - The display looks similar to the following.

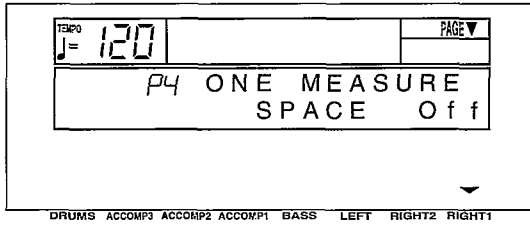

9. Use the **RIGHT 1** ^ and v buttons to select **ONE MEASURE SPACE On/Off**.
 - When there is various data other than performance data stored at the beginning of a file, the start of playback may be delayed. This can be avoided by inserting a one-measure space before the beginning of the performance. Select On to insert a one-measure space. Select Off if you do not wish to insert the space.
 - When set to On, a space is added each time a file is saved. Therefore, if you have already saved a file once with the **ONE MEASURE SPACE** set to On, please set it to Off each time the file is subsequently saved.

10. Press the **EXECUTE (SYNCHRO & BREAK)** button.
 - The **SAVE** operation begins.
 - When the operation has been successfully completed, "COMPLETED!" is shown on the display.
 - If you attempt to save data to a file number in which data is currently saved, the display changes to the confirmation display. Press either **RIGHT 1** (No) button if you wish to cancel the procedure. When either **LEFT** (Yes) button is pressed, the **SMF SAVE** operation begins.

FILE delete

Use the following procedure to clear a specific file.

1. On the **SMF NAMING** display, press the **PAGE** ^ button.
 - The display looks similar to the following.

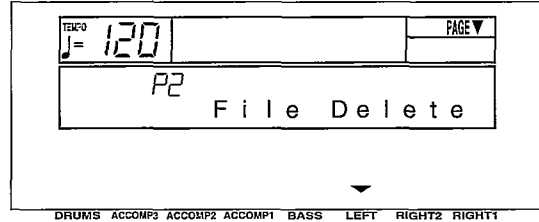

2. Press either **LEFT** button.
 - The display looks similar to the following.

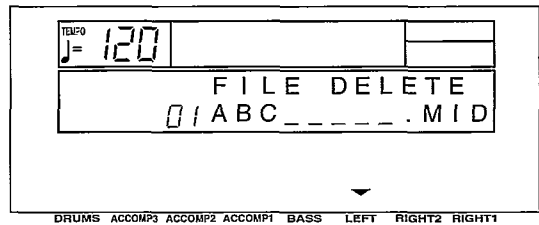

3. Use the **LEFT** ^ and v buttons to specify the file to erase.
4. Press the **EXECUTE (SYNCHRO & BREAK)** button.
 - The **ARE YOU SURE?** display appears. Press either **LEFT** (Yes) button to execute the function. Or press either **RIGHT 1** (No) button if you wish to cancel the procedure.

Part VIII Adjusting the sounds

Outline of the Sound Setting mode



The **SOUND SETTING** mode is used for making fine adjustments to the functions related to sound, such as tone, volume and effects.

SOUND menu

1. Press the **SOUND SETTING** button to turn it on.

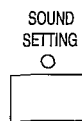

2. Use the **PAGE** buttons to select the menu.
 - There are four pages of the menu display.
3. Select the desired menu and follow the procedures on the corresponding setting display.
 - When the current display is a setting display, you can press the **EXIT** button to go back to the previous display. To show other menus, use the **EXIT** button to return to the **SOUND** menu display and make another selection.
4. When you have finished setting the functions, press the **SOUND SETTING** button to turn it off.

■ A word about parts

The organization of the sound parts is as follows.

Normal parts:

RIGHT 1, RIGHT 2, LEFT, PART 4 to 16
(PART 16 is reserved for the DRUM part)

AUTO PLAY CHORD parts:

ACCOMP 1, 2, 3, BASS, DRUMS, CHORD,
R.BASS.

MANUAL SEQUENCE PADS part:

MSP

METRANOME part: METRO

- On the **BALANCE** display, PART 1, PART 2 and PART 3 become RIGHT 1, RIGHT 2 and LEFT, respectively.

Summary of the SOUND menu items

P1 Part Setting (page 102)

Set the various sound attributes for each part.

P2 Touch & Tune (page 103)

Set the keyboard sensitivity, and adjust the tuning.

P3 Key Scaling (page 104)

Select the type of scaling (tuning).

P4 Left Hold (page 105)

Set the mode which determines how the **LEFT** part sounds during an **AUTO PLAY CHORD** performance.

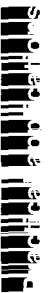

Part Setting

Set the various sound attributes for each part.

1. On the **SOUND** menu display, select [P1 Part Setting].

- The display looks similar to the following.

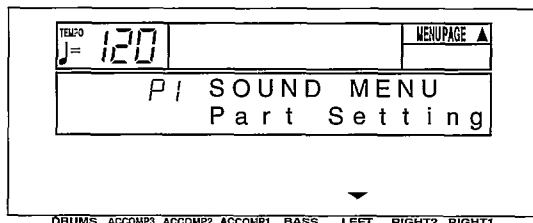

2. Press either **LEFT** button.

- The display looks similar to the following.

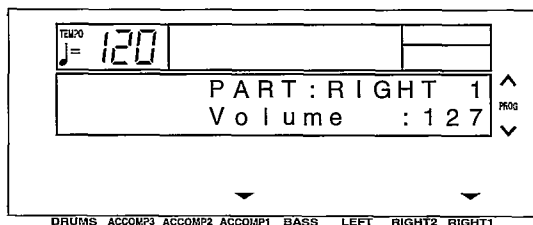

3. Use the **TRANSPOSE** (PROG) ^ and v buttons to select a part.

- PART 4 to 16 are used in **SEQUENCER** and MIDI functions when playing back Standard MIDI Files. PART 16 is reserved for the DRUM part.
- For information concerning CHORD and R. BASS, refer to page 51.

4. Assign a sound to the selected part.

- If the **SOUND/PART** button is pressed, the currently selected part and sound name are shown on the display.
- Only sounds from the **KEYBOARD PERC** can be selected for Part 16.
- You cannot assign sounds to the ACCOMP 1, 2, 3, BASS, DRUMS, MSP and METRO parts. (If the panel buttons are used to change the sound or effects for these parts, the RIGHT 1 settings change.)

5. Use the **ACCOMP** 1 ^ and v buttons to select the attribute you wish to adjust.

6. Use the **RIGHT 1** ^ and v buttons to adjust the attribute.

Volume: Adjust the volume of each part (0 to 127).

Pan: Adjust the stereo balance of each part (L64–CTR–R63).

- At L64, the sound is completely to the left, at R63 completely to the right. At CTR, the sound is at the center.
- Even at the same numerical value, the stereo balance may differ slightly depending on the sound.

Reverb: Adjust the depth of the reverb for the part (0 to 127).

Chorus (KN720): Adjust the depth of the **CHORUS** (0 to 127).

DSP Eff. (KN920/KN1500): Adjust the depth of the **DSP EFFECT** (0 to 127).

S. Length: Adjust the length of the sustain (1 to 8).

- For some sounds, the length of the sustain does not change even if the number is changed.

KeyShift: Specify the amount of shift in the pitch of the played keys (–12 to +12).

- A value of 1 means a shift of one semitone. A value of 12 is one octave.
- The – button is used to lower the pitch, and the + button to raise the pitch.

Tuning: Fine-tune the pitch of each part (–128 to +127).

- Slight differences in the pitches between the parts add fullness to the sound.
- The – button is used to lower the pitch, and the + button to raise the pitch.

P.Bend: Set the amount of pitch change when the **PITCH BEND** wheel is operated (0 to 12).

- Increments are in semitones. A value of 12 is one octave.

Glide Pdl: Enable or disable the glide effect of the pedal (Foot Switch) (On/Off).

- For glide pedal setting, refer to page 58.

Sust. Pdl: Specify whether or not the **SUSTAIN** effect is applied with the pedal (Foot Switch) (On/Off).

Key Scale: Enable or disable key scaling (On/Off)

- For key scaling, refer to page 104.

- The settings which can be adjusted may differ depending on the selected part.
- If **KEYBOARD PERC** sounds are assigned to a part other than PART 16, even if you change the setting for the attribute (except for Volume, Reverb, Chorus [KN720]/DSP Eff [KN920/KN1500]), the new setting will not be in effect.
- To change the settings for a different part while the setting display is shown, use the **TRANSPOSE (PROG)** \wedge and \vee buttons to change the part.
- When you have completed adjustment of an attribute, use the **ACCOMP 1** \wedge and \vee buttons to select the next attribute you wish to adjust.

Touch & Tune

Select the keyboard touch response mode (TOUCH SENSE) and fine-tune the pitch of the entire instrument (TUNING).

1. On the **SOUND** menu display, select [P2 Touch & Tune].

- The display looks similar to the following.

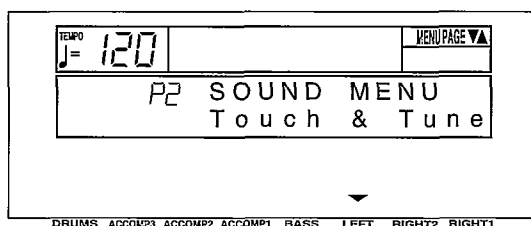

2. Press either **LEFT** button.

- The display looks similar to the following.

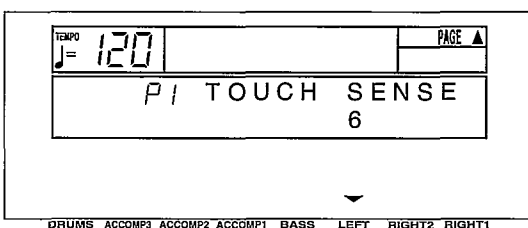

3. Use the **LEFT** \wedge and \vee buttons to select the touch mode.

- Select from 0 to 9.
- When 0 is selected, the keyboard touch response is turned off.

4. Press the **PAGE** \wedge button.

- The display looks similar to the following.

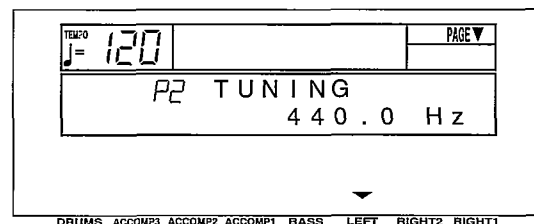

5. Use the **LEFT** \wedge and \vee buttons to adjust the pitch within a range of 427.3 to 453.0 Hz.

- The decimal can be set to 0, 3 or 6.

Key Scaling

The temperament (tuning) of this instrument can be adjusted. Various types other than standard temperament are available to choose from.

1. On the **SOUND** menu, select [P3 Key Scaling].
- The display looks similar to the following.

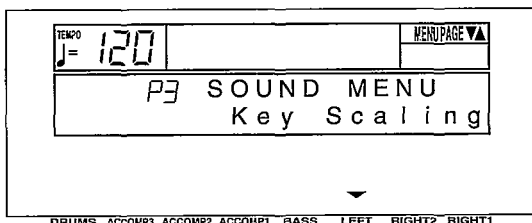

2. Press either **LEFT** button.
- The display looks similar to the following.

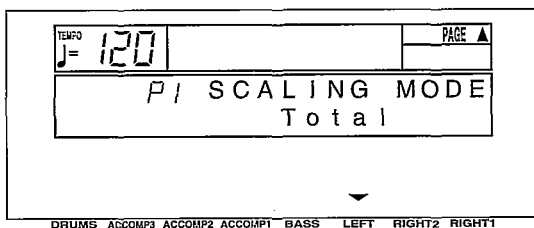

3. Use the **LEFT** \wedge and \vee buttons to select the tuning mode.

Total: The key scaling selected for this instrument is active for all parts. (Select this mode if you are selecting a tuning type.)

Sound: The preset key scaling specified for individual sounds is active.

4. Press the **PAGE** \wedge button.
- The display looks similar to the following.

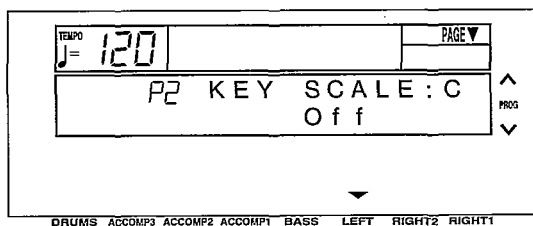

5. Use the **LEFT** \wedge and \vee buttons to select the type.
 - Select from [Off], [Random], [Piano], [Orchestra], [Pythagorean], [Werckmeister], [Kirnberger], [Arabic 1] to [Arabic 5], [Slendro], [Pelog], [User].
 - [Off] is standard (equal temperament) tuning.
 - Select [User] if you wish to use a customized scaling (explained in the following section).

6. Use the **TRANSPOSE** (PROG) \wedge and \vee buttons to select the key in which you are going to perform.
 - Set to the key of the song you are going to play.

■ User type scaling

You can adjust the instrument to a customized scaling.

- In **KEY SCALING**, the pitch of each note of the octave is slightly shifted up or down from the standard (equal temperament) tuning.

1. On the P2 display, select [User] for the type.

2. Press the **PAGE** \wedge button.
- The display looks similar to the following.

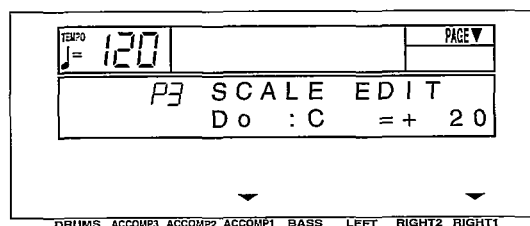

3. Adjust the key scaling.

- Use the **ACCOMP 1** \wedge and \vee buttons to specify the keyboard key, and use the **RIGHT 1** \wedge and \vee buttons to adjust the pitch of the key.
- Increments are in cents (one hundredth of an equal-tempered semitone). A + value raises the pitch and a - value lowers the pitch in relation to standard tuning (equal temperament).

Left Hold

Select the mode to specify how the left section of the keyboard sounds during an **AUTO PLAY CHORD** performance.

1. On the **SOUND** menu display, select [P4 Left Hold].
 - The display looks similar to the following.

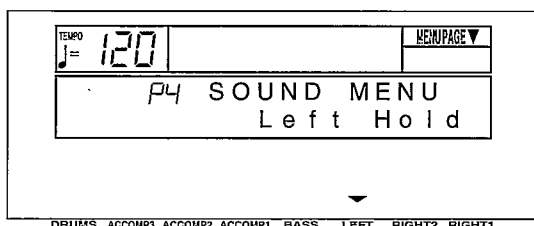

2. Press either **LEFT** button.
 - The display looks similar to the following.

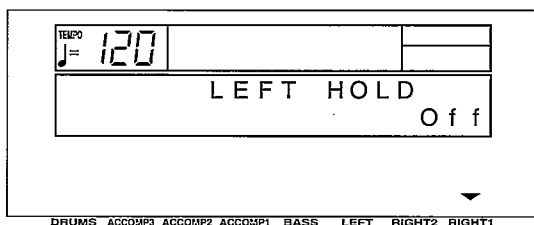

3. Use the **RIGHT 1** buttons to set the mode to On or Off.

■ **OFF**

	ONE-FINGER	FINGERED	PIANIST
When rhythm is stopped	The specified chord sounds in the CHORD part sound.	The specified chord sounds in the CHORD part sound, and the pressed keys sounds in the LEFT part sound.	The CHORD part and the LEFT part do not sound (the entire keyboard produces the RIGHT part sound).
When rhythm is playing	The CHORD part and the LEFT part do not sound.	The CHORD part does not sound, but the pressed keys sound in the LEFT part sound.	

■ **ON**

	ONE-FINGER	FINGERED	PIANIST
When the rhythm is stopped or playing	The specified chord sounds in the LEFT part sound.	The specified chord sounds in the LEFT part sound.	The CHORD part and the LEFT part do not sound (the entire keyboard produces the RIGHT part sound).

- The **LEFT** part can be heard only when the **LEFT** button in the **CONDUCTOR** section is on.

Part IX Creating sounds (KN920/KN1500)

Outline of the Sound Edit

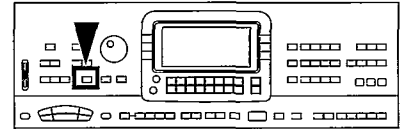

SOUND EDIT enables you to create your own new sound by altering one of the this instrument's preset sounds. Your new sound can be stored in one of the sound memory locations.

1. Select a preset sound on which to build your new sound.
 - The sounds in the **KEYBOARD PERC** group (189 to 200) cannot be edited.
2. Press the **SOUND EDIT** button to turn it on.



- The display looks similar to the following.

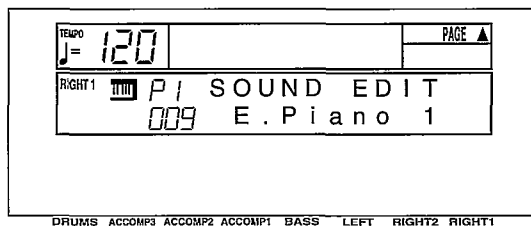

- The sound you selected in step 1 is shown.
3. Use the **PAGE** buttons to select a menu.
 - You can select from the following menus.

P2 SOUND NAMING (page 107)

Assign a name to your sound.

P3 WRITE (page 107)

Select a memory number to save the new sound.

P4 OCTAVE SHIFT (page 107)

Shift the octave range of the sound.

P5 D. EFFECT (page 108)

Select the type of **DIGITAL EFFECT** to apply to the sound.

P6 VIBRATO (page 108)

Specify the various vibrato settings.

P7 TONE SEL (TONE SELECT) (page 108)

Modify the tones which make up the sound.

P8 PITCH (page 109)

Adjust the settings related to the pitch of the sound.

P9 MIXER (page 109)

Adjust the volume, brilliance and stereo balance of the sound.

P10 ENVELOPE (page 110)

Specify how the volume changes over time.

P11 PTCH ENV (PITCH ENVELOPE)

(page 110)

Specify how the pitch changes over time.

4. Select a menu item and adjust the setting.
 - **KN1500:** When the **TEMPO/PROGRAM** indicator is lit, it indicates that the dial is available for setting the current function.
5. Repeat steps 3 and 4 to modify other sound attributes as desired.
 - Use the **PAGE** buttons to select different menus.
6. When the sound is just the way you like it, use the **PAGE** buttons to select P3 WRITE, and follow the procedure to store your new sound. (Refer to page 107.)

■ About TONES

A sound may be made up of at most four TONES.

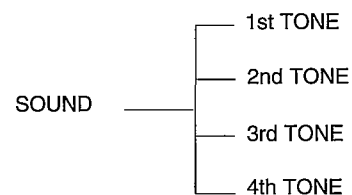

- The essence of the sound is created by the combination of the 1st TONE and 2nd TONE. Depending on the sound output status of the instrument, the 3rd and 4th TONES may not be generated.
- There are two types of settings: those that can be adjusted for each TONE that comprises the sound, and those that can be adjusted for the whole sound. For settings that can be adjusted for each TONE, the **TRANSPOSE (PROG)** ^ and v buttons to the right of the display are used to specify the TONE.

Setting the function

SOUND NAMING

Assign a name to the sound you are creating.

1. Use the **PAGE** buttons to select [P2 SOUND NAMING].
 - The display looks similar to the following.

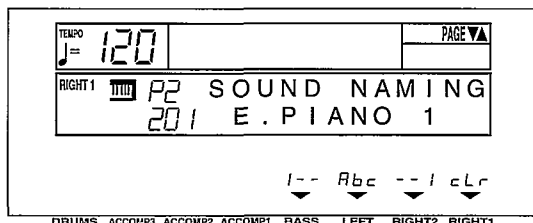

2. Type a new name for your sound (up to 12 characters).
 - Use the **BASS** and **RIGHT 2** buttons to highlight the character position. Use the **LEFT** (Abc) buttons to select the alphanumeric character. Repeat these steps to type the whole name.
 - To erase the name, press either **RIGHT 1** (cLr) button.

WRITE

The sound numbers **201** to **240** in the **SOUND MEMORY** are reserved for storing the sounds you create with the **SOUND EDIT**.

- Your new sound will be erased if you exit the **SOUND EDIT** mode without first storing it in a memory.

1. Use the **PAGE** buttons to select [P3 WRITE TO].
 - The display looks similar to the following.

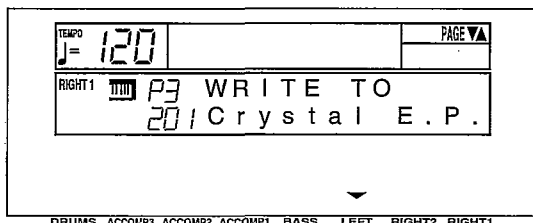

3. When you are finished editing the sound, if you wish to save it, press the **EXECUTE** (**SYNCHRO & BREAK**) button to store the new sound.

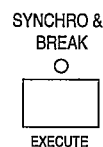

2. Use the **LEFT** ^ and v buttons to select the **MEMORY** number in which to store the new sound (201 to 240).

OCTAVE SHIFT

Set the pitch of the sound by octaves.

1. Use the **PAGE** buttons to select [P4 OCTAVE SHIFT].
 - The display looks similar to the following.

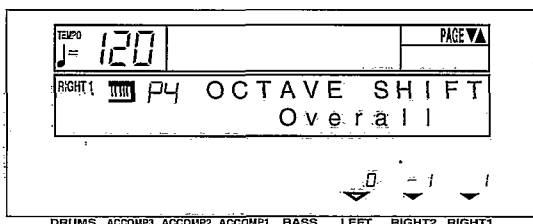

2. Use the **LEFT** ^ and v buttons to set the octave for the whole keyboard ([Overall]) (-2 to 2).
3. Use the **RIGHT 2** ^ and v buttons to set the octave for the **LEFT** part when the keyboard is split ([Split Left]) (-2 to 2).
4. Use the **RIGHT 1** ^ and v buttons to set the octave for the **RIGHT** parts when the keyboard is split ([Split Right]) (-2 to 2).

DIGITAL EFFECT

Select the type of **DIGITAL EFFECT** for your sound. When the **DIGITAL EFFECT** button is on, the type you set will be active for your sound.

1. Use the **PAGE** buttons to select [P5 D. EFFECT].
- The display looks similar to the following.

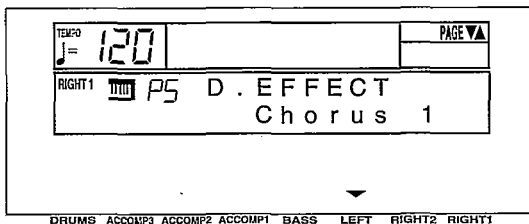

2. Use the **LEFT** \wedge and \vee buttons to select the type of effect.
- Select from [Off], [Celeste 1, 2], [Chorus 1, 2], [Ensemble 1, 2], [Tremolo], [Organ Tremolo], [Single Delay], [Repeat Delay], [Solo Effect 1, 2].
- If a type other than [Off] is selected, the **DIGITAL EFFECT** button will turn on when the sound is selected.
- If the [Organ Tremolo] effect is selected, use the **DIGITAL EFFECT** button now to specify **FAST** (**DIGITAL EFFECT** button on) or **SLOW** (off) when the sound is selected.

VIBRATO

Modify the vibrato attributes of the sound.

1. Use the **PAGE** buttons to select [P6 VIBRATO].
- The display looks similar to the following.

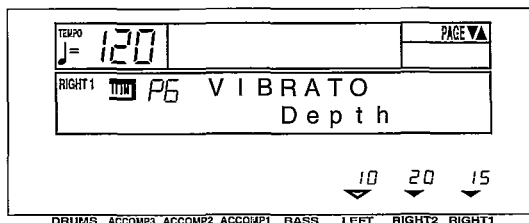

2. Use the **LEFT** \wedge and \vee buttons to adjust the vibrato depth ([Depth]) (OFF, 1 to 127).
3. Use the **RIGHT 2** \wedge and \vee buttons to adjust the vibrato speed ([Speed]) (0 to 127).
4. Use the **RIGHT 1** \wedge and \vee buttons to set the time delay between key played and vibrato start ([Delay]) (0 to 30).

TONE SELECT

Modify the separate **TONEs** which comprise the sound.

- **TONEs** are explained on page 106.
1. Use the **PAGE** buttons to select [P7 TONE SEL].
- The display looks similar to the following.

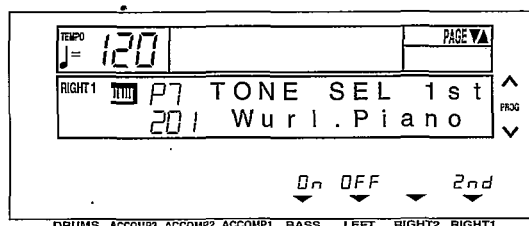

2. Use the **TRANSPOSE** (**PROG**) \wedge and \vee buttons to select the **TONE** ([1st], [2nd], [3rd], or [4th]).
3. Use the **RIGHT 2** \wedge and \vee buttons to select a sound for the **TONE**.
4. Use the **RIGHT 1** \wedge and \vee buttons to select one **TONE** from the sound selected in step 3.
 - The number of **TONEs** may differ depending on the selected sound.
 - If either **LEFT** (OFF) button is pressed, the **TONE** will not sound. If either **BASS** (On) button is pressed, the **TONE** will be turned on.
 - When a **TONE** is selected, the **MIXER**, **ENVELOPE** and **PITCH ENVELOPE** settings change to those of the selected **TONE**.
5. Repeat steps 2 to 4 for each **TONE**, as desired.

SOUND SOURCE

PITCH

Adjust the output pitch of each TONE.

1. Use the **PAGE** buttons to select [P8 PITCH].
 - The display looks similar to the following.

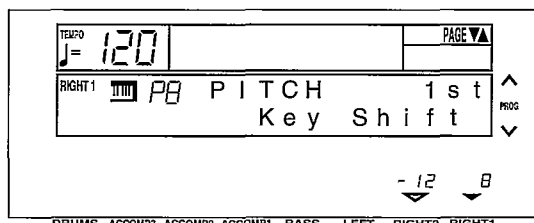

2. Use the **TRANSPOSE** (PROG) \wedge and \vee buttons to select a TONE.
3. Use the **RIGHT 2** \wedge and \vee buttons to specify the output pitch ([Key Shift]) (-24 to 24).
 - Units are in semitones.
4. Use the **RIGHT 1** \wedge and \vee buttons to fine-adjust the pitch ([Detune]) (-128 to 127).
 - Slight differences in the [Detune] values between the tones add fullness to the sound.
5. Repeat steps 2 to 4 for each TONE, as desired.

MIXER

Adjust the volume, brilliance and stereo balance of each TONE.

1. Use the **PAGE** buttons to select [P9 MIXER].
 - The display looks similar to the following.

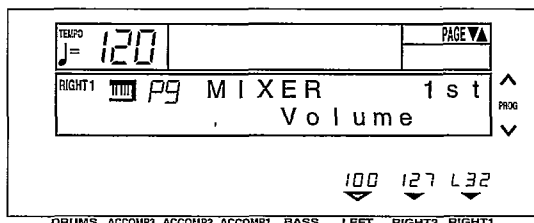

2. Use the **TRANSPOSE** (PROG) \wedge and \vee buttons to select a TONE.
3. Use the **LEFT** \wedge and \vee buttons to adjust the volume ([Volume]) (0 to 127).
4. Use the **RIGHT 2** \wedge and \vee buttons to adjust the brightness ([Brilliance]) (0 to 127).
5. Use the **RIGHT 1** \wedge and \vee buttons to adjust the stereo balance ([Pan]) of the sound (L64–Ctr–r63, rnd).
 - Ctr is the center point. At L64, the sound is all the way to the left, at r63 all the way to the right.
 - If [rnd] is selected the stereo balance changes randomly each time a key is pressed.
 - Even at the same numerical value, the stereo balance may differ slightly depending on the sound.
6. Repeat steps 2 to 5 for each TONE, as desired.

ENVELOPE

For each tone, specify the waveform (envelope) of volume change, from the time the key is played to the time the sound dies out.

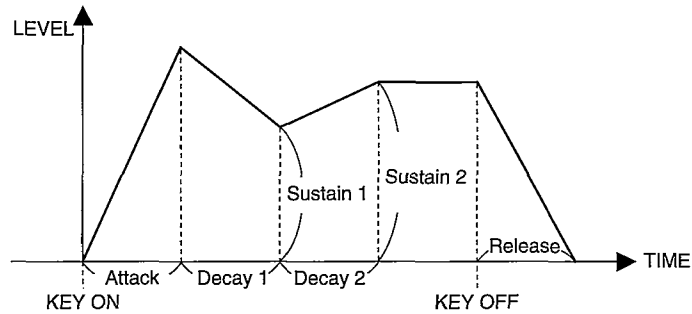

1. Use the **PAGE** buttons to select [P10 ENVELOPE].
- The display looks similar to the following.

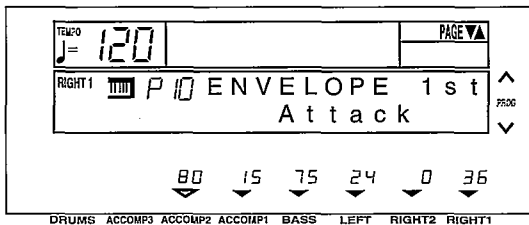

3. Use the \wedge and \vee buttons below the display to modify the envelope (0 to 100).

- ACCOMP 2: [Attack]
- ACCOMP 1: [Decay 1]
- BASS: [Sustain 1]
- LEFT: [Decay 2]
- RIGHT 2: [Sustain 2]
- RIGHT 1: [Release]

2. Use the **TRANSPOSE** (PROG) \wedge and \vee buttons to select a TONE.

4. Repeat steps 2 and 3 for each TONE, as desired.

PITCH ENVELOPE

For each tone, specify the waveform (envelope) of pitch change, from the time the key is played to the time the sound dies out.

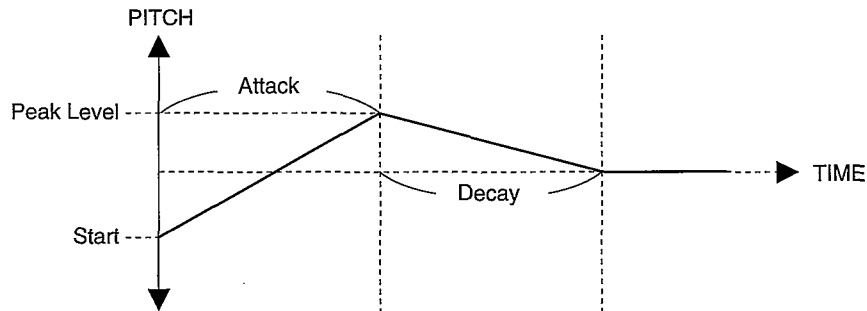

1. Use the **PAGE** buttons to select [P11 PTCH ENV].
- The display looks similar to the following.

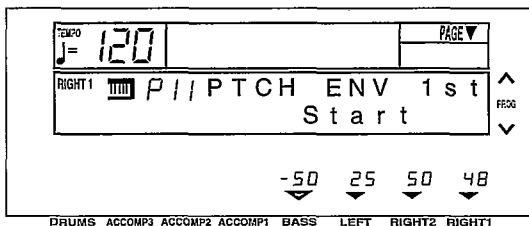

2. Use the **TRANSPOSE** (PROG) \wedge and \vee buttons to select a TONE.

3. Use the \wedge and \vee buttons below the display to modify the envelope.

- BASS: [Start] (-50 to 50)
- LEFT: [Attack] (0 to 100)
- RIGHT 2: [Peak Level] (-50 to 50)
- RIGHT 1: [Decay] (0 to 100)

4. Repeat steps 2 and 3 for each TONE, as desired.

Part X MIDI

What is MIDI?

MIDI (Musical Instrument Digital Interface) is the international standard for digital communication of electronic musical instrument data. This means that any equipment which has a MIDI terminal—such as electronic musical instruments and personal computers—can easily exchange digital data with other MIDI equipment without resorting to complicated conversions or connections.

MIDI terminals

(On the rear panel)

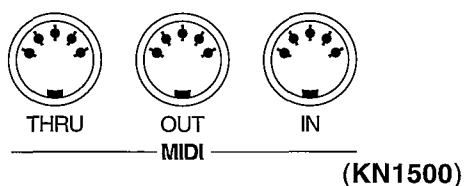

IN:

The terminal by which this instrument receives data from other equipment.

OUT:

The terminal that transmits data from this instrument to other equipment.

THRU (KN1500):

The terminal that transfers data from the IN terminal directly to other equipment.

- For these connections, use a commercially available MIDI cable.

Connection examples

- To generate sound from a connected instrument by playing this instrument

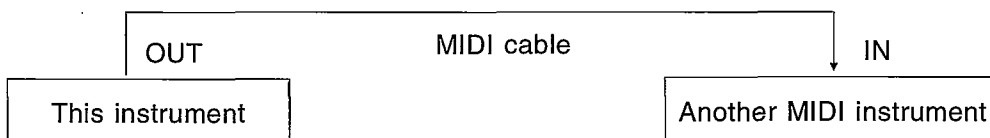

- To generate sound from this instrument by operating a connected instrument

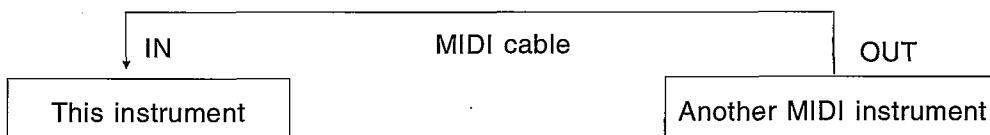

- To connect with a MIDI sequencer or a personal computer

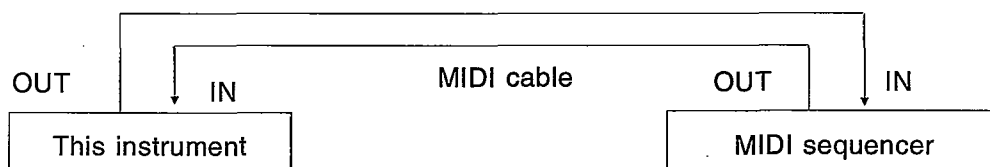

MIDI channels

Many different kinds of performance data are sent using just one MIDI cable. This is possible because MIDI signals are sent and received through 16 different “basic channels” (numbered 1 to 16). In order for the exchange of data to take

place, the channels on the transmission side must match the channels on the receiving side. This characteristic also makes it possible to link multiple sound generators and to control each by matching specific channels.

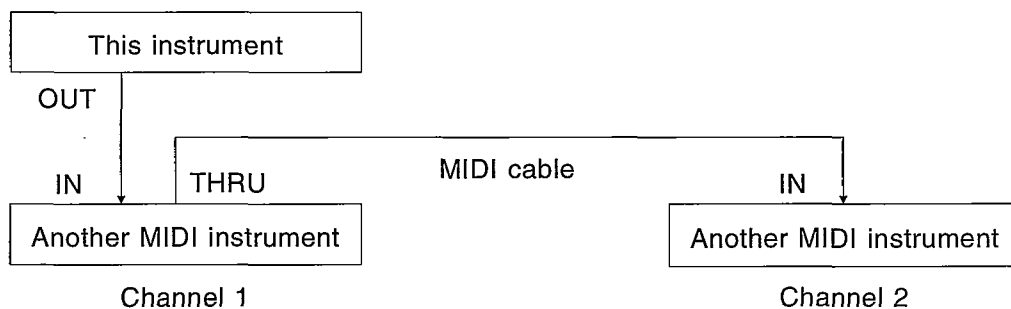

The following kinds of data can be transmitted/received.

■ NOTE data

This is the most basic kind of MIDI data which is exchanged, and is used to specify which keys are played and how hard they are played.

NOTE NUMBER: Number specifying which key is played.

NOTE ON: Specifies that a key is played.

NOTE OFF: Specifies that a key is released.

VELOCITY: Specifies how hard a key is struck.

- MIDI notes are assigned numbers from 0 to 127, with middle C (C3) as 60. Note pitches are in semitone increments, with the higher numbers assigned to the higher pitches.

■ PROGRAM CHANGE

This is sound change data. When a different sound is selected on the transmitting instrument, the sound on the receiving instrument also changes.

■ CONTROL CHANGE

These are volume, sustain, effect, etc. data used to enhance performance expression. Each function is distinguished by its control number, and the function which can be changed by the control differs depending on the instrument.

■ EXCLUSIVE data

This is sound data, etc. particular to a specific instrument model. This data can also be transmitted and received by the DUMP function.

- For details, refer to the separate REFERENCE GUIDE provided.

GENERAL MIDI

GENERAL MIDI (GM) is the standard which enables MIDI data exchange between different models or equipment of different manufacture. Program change numbers and their corresponding sounds, percussion instrument sounds, note numbers, etc. are data-compatible between equipment using this standard. Song data created on the equipment of one manufacturer can be played back on the equipment of a different manufacturer, as long as both conform to the GENERAL MIDI standard. This instrument conforms to this standard and can be used as a GENERAL MIDI sound generator.

Equipment which conforms to GENERAL MIDI standards is indicated by the following logo.



Outline of MIDI functions

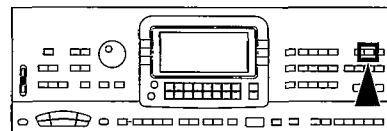

Select the various settings which are used for MIDI operation of this instrument.

1. Press the **MIDI** button to turn it on.



2. Use the **PAGE** buttons to select the menu.
 - There are nine pages of the menu display.
3. Select the desired menu and follow the procedures on the corresponding setting display.
 - During the setting display, you can press the **EXIT** button to go back to the previous display. To show other menus, use the **EXIT** button to return to the **MIDI** menu display and make another selection.
4. When you have finished setting the functions, press the **MIDI** button to turn it off.

Summary of the MIDI menu items

P1 Channel (page 114)

Assign a MIDI channel to each part.

P2 Part Setting (page 115)

Make the OCTAVE and LOCAL CONTROL settings for each part.

P3 Common Set (page 116)

Set the following functions which are common to all parts.

NOTE ONLY
 PROG. CHANGE TO P. MEM
 INTRO, FILL-IN, ENDING
 REALTIME SYSEX
 APC CONTROL
 TRANSPOSE
 PROGRAM CHANGE MODE
 DRUMS TYPE
 SONG SELECT
 MIDI SETUP LOAD

P4 Control Msg (CONTROL MESSAGE) (page 117)

Enable or disable the exchange of various control data.

P5 IN/OUT Set (INPUT/OUTPUT SETTING) (page 118)

Various settings related to transmission and reception of data

P6 Realtime Msg (REALTIME MESSAGE) (page 119)

Make the REALTIME COMMANDS and CLOCK settings.

P7 MIDI Presets (page 119)

Optimum MIDI settings according to the connected equipment

P8 GM Mode (page 120)

GENERAL MIDI settings

P9 Bulk Dump (page 121)

Settings related to data exchange of this instrument's internal data.

Setting the functions

MIDI CHANNEL

MIDI Basic Channel numbers have already been assigned to parts (default settings) but you can reassign channel number to parts as follows.

1. On the **MIDI** menu display, select [P1 Channel].
 - The display looks similar to the following.

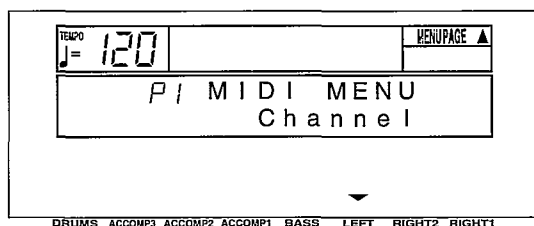

2. Press either **LEFT** button.
 - The display looks similar to the following.

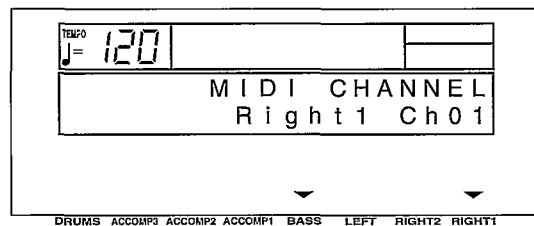

3. Use the **BASS** \wedge and \vee buttons to select the part.
4. Use the **RIGHT 1** \wedge and \vee buttons to select a basic channel for the part (Off, 01 to 16).
 - A part which has been set to Off cannot be used to transmit or receive MIDI data.
5. Repeat steps 3 and 4 for each part as desired.

■ Default part settings

Part	Channel	Part	Channel	Part	Channel	AUTO PLAY CHORD part	Channel
Right 1	01	Part 7	07	Part 13	13	Acmp 1	Off
Right 2	02	Part 8	08	Part 14	14	Acmp 2	Off
Left	03	Part 9	09	Part 15	15	Acmp 3	Off
Part 4	04	Part 10	10	Part 16	16	Bass	Off
Part 5	05	Part 11	11	(Drum)		Drums	Off
Part 6	06	Part 12	12	Control	Off	Chord	Off

PART SETTING

Set the octave shift value for key notes transmitted from this instrument (OCTAVE), and specify whether this instrument's sound generator is enabled when MIDI data is transmitted (LOCAL CONTROL).

- On the **MIDI** menu display, select [P2 Part Setting].
- The display looks similar to the following.

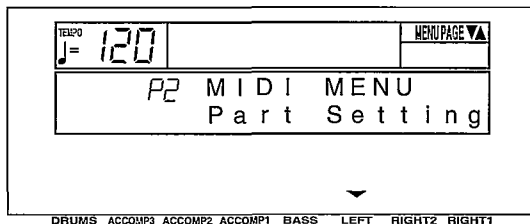

- Press either **LEFT** button.
- The display looks similar to the following.

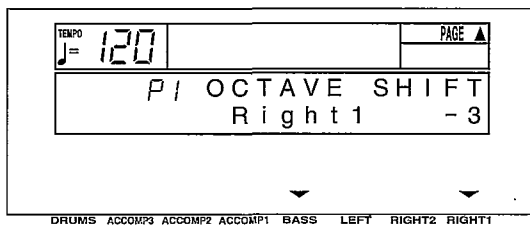

- Use the **BASS** \wedge and \vee buttons to select the part.
- Use the **RIGHT 1** \wedge and \vee buttons to set the octave shift value (-3 to 3).
 - Octave shift is set for transmitted data only; however the transmitted and received octave shifts are linked. For example, if the transmitted octave shift is set to 1, the received octave shift is automatically set to -1.
- Repeat steps 3 and 4 for each part, as necessary.

- Press the **PAGE** \wedge button.
- The display looks similar to the following.

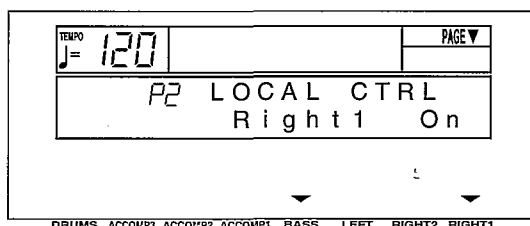

- Use the **BASS** \wedge and \vee buttons to select a part.

- Use the **RIGHT 1** \wedge and \vee buttons to enable or disable this instrument's sound generator.
 - When set to On, the performance from this instrument is transmitted as MIDI data and also sounds from this instrument. When set to Off, the performance from this instrument is transmitted as MIDI data but does not sound from this instrument.

- Repeat steps 7 and 8 for each part as desired.



COMMON SETTING

Set the functions which are common to all parts.

1. On the **MIDI** menu display, select [P3 Common Set].

- The display looks similar to the following.

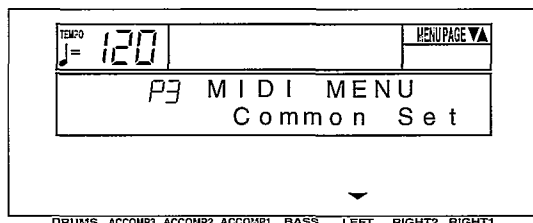

2. Press either **LEFT** button.

- The display looks similar to the following.

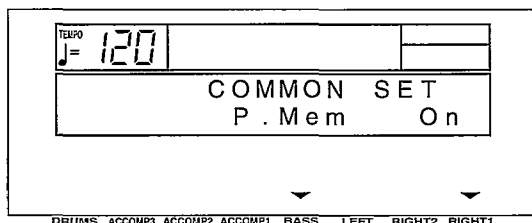

3. Use **BASS** ^ and v buttons to select the item.

4. Use the **RIGHT 1** ^ and v buttons to change the setting.

[P. Mem] (PROGRAM CHANGE TO PANEL MEMORY): Enable or disable the exchange of program change numbers for the **RIGHT 1** part by operation of the **PANEL MEMORY** buttons (On/Off).

- **KN920/KN1500**: For this setting, the **PANEL MEMORY 1** to **5** program change numbers correspond to the bank numbers as follows: **BANK A** = 0 to 4; **BANK B** = 5 to 9.

[Note Only]: Of the performance data, specify whether or not only note data is exchanged (On/Off).

[P. Change] (PROGRAM CHANGE MODE)

Nor: The program change numbers correspond to the sound numbers.

Tec: Program change numbers are standardized among all Technics models which are set to this mode. The program change number assigned to a given sound on one model is assigned to the same sound on all models which are set to the same mode.

GM: Program change numbers follow the GM standard.

- The program change numbers for each mode can be found in the separate **REFERENCE GUIDE** provided.

[Drums]

Nor: Keyboard percussion instrument sounds correspond to this instrument's key note numbers.

Tec: Keyboard percussion instrument sounds correspond to the same key note numbers for connected Technics models set to this type.

GM: Keyboard percussion instrument sounds follow the GM standard.

[Song Sel] (SONG SELECT)

On: Song number data can be exchanged.

Off: Song number data cannot be exchanged.

[Setup Ld] (MIDI SETUP LOAD)

On: When disk data is loaded, the MIDI settings stored on the disk are automatically recalled.

Off: MIDI settings stored on the disk are not recalled.

[Intro]: Enable or disable the exchange of intro, fill-in and ending data (On/Off).

- Data is exchanged on the channel for the **DRUMS** part.

[APC Ctrl] (APC CONTROL): Enable the exchange of data for the on/off status of the **AUTO PLAY CHORD's ONE-FINGER, FINGERED** and **PIANIST** modes (On/Off).

- Data is exchanged on the channel for the **ACCOMP 1** part.

[RT Sysex] (REALTIME SYSTEM EXCLUSIVE): Specify whether or not **SYSTEM EXCLUSIVE** data is exchanged during the performance (On/Off).

5. Repeat steps 3 and 4 for the other settings as desired.

CONTROL MESSAGE

Enable or disable the exchange of various control data.

1. On the **MIDI** menu display, select [P4 Control Msg].
 - The display looks similar to the following.

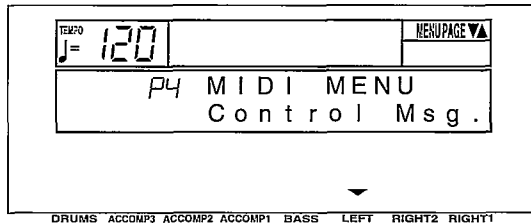

2. Press either **LEFT** button.
 - The display looks similar to the following.

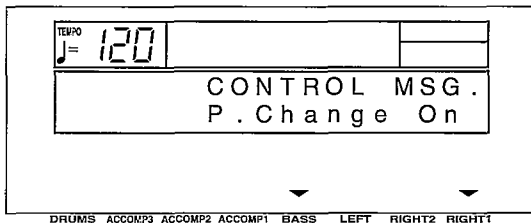

3. Use the **BASS** \wedge and \vee buttons to select the control message.
 - Select from the following: P.Change (PROGRAM CHANGE), Bank Sel (BANK SELECT), P.Bend (PITCH BEND), Volume, Express. (EXPRESSION), Panpot, Sustain, EFF&REV (EFFECT & REVERB), Modulat. (MODULATION), Tuning, Bend Rng (BEND RANGE), AftTouch (AFTER TOUCH), Rst.Cnt. (RESET ALL CONTROLLERS).

4. Use the **RIGHT 1** \wedge and \vee buttons to specify on or off for the control message.

On: Data for the control operation is exchanged.

Off: Data for the control operation is not exchanged.

- The [Bank Sel] setting is effective only when [P. Change] is set to On.
 - The [EFF&REV] setting controls the **DIGITAL EFFECT** and **DIGITAL REVERB** on/off.
 - The [Tuning] setting is the on/off setting for the Tuning and Key Shift settings.
5. Repeat steps 3 and 4 for each control as desired.



INPUT/OUTPUT SETTING

Make the settings which determine how various performance data is treated during data transmission and reception.

- On the **MIDI** menu display, select [P5 IN/OUT Set].
 - The display looks similar to the following.

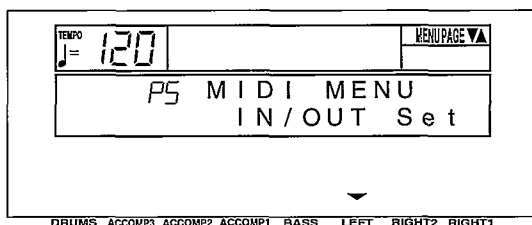

- Press either **LEFT** button.
 - The display looks similar to the following.

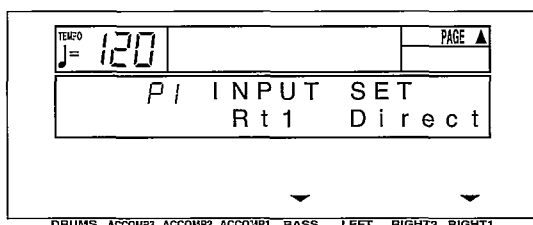

- Use the **BASS** ▲ and ▼ buttons to select the item.
- Use the **RIGHT 1** ▲ and ▼ buttons to change the setting.

[Rt1] (RIGHT 1 INPUT)

Cond: When data for the **RIGHT 1** part is received, the **CONDUCTOR** determines which part it is used for.

Direct: When data for the **RIGHT 1** part is received, it is treated as **RIGHT 1** data, and performance data for all parts is received on their respective basic channels.

[APC] (APC INPUT)

On: Input data for the **ACCOMP 1, 2, 3, BASS, DRUMS** and **CHORD** parts is received.

Off: Data for the above parts is not received.

- Basic channels should be assigned to the above parts before exchanging data.

- Press the **PAGE** ▲ button.
 - The display looks similar to the following.

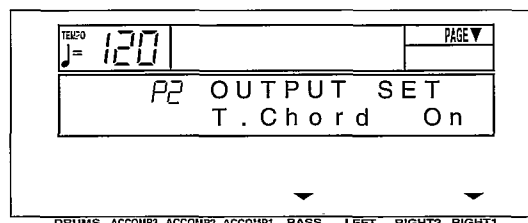

- Use the **BASS** ▲ and ▼ buttons to select the output item.
- Use the **RIGHT 1** ▲ and ▼ buttons to change the setting.

[T.Chord] (TECHNI-CHORD OUTPUT)

On: Keyboard notes generated by the **TECHNI-CHORD** function are also transmitted.

Off: Only key note data of the pressed keys is transmitted.

[Drums] (DRUMS OUTPUT)

On: Data from the **DRUMS** part is transmitted.

Off: Data from the **DRUMS** part is not transmitted.

[APC] (APC OUTPUT)

On: The data for the **ACCOMP 1, 2, 3, BASS** and **CHORD** parts is transmitted.

Off: The data for the above parts is not transmitted.

- Basic channels should be assigned to the above parts before exchanging data.

[Trans.] (TRANSCOPE)

On: The note number of the transposed note is transmitted/received.

Off: The note number of the played key is transmitted/received.

REALTIME MESSAGE

Enable or disable the exchange of **START/STOP** data (REALTIME COMMANDS), and select the **CLOCK** mode.

1. On the **MIDI** menu display, select [P6 Realtime Msg].
 - The display looks similar to the following.

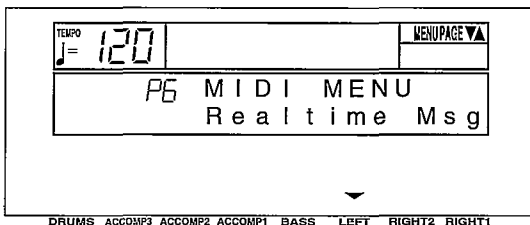

2. Press either **LEFT** button.
 - The display looks similar to the following.

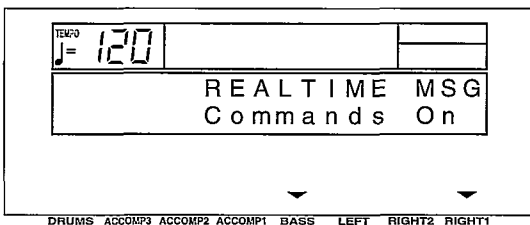

3. Use the **BASS** ^ and v buttons to select a function (Commands/Clock).

4. Use the **RIGHT 1** ^ and v buttons to change the setting.

[Commands]

On: Rhythm and **SEQUENCER** start/stop, continue, and song position pointer data can be transmitted/received.

Off: This data cannot be transmitted/received.

[Clock]

Int: This instrument's internal clock is used to control the performance. The clock of the connected equipment is disabled.

Mid: The clock of the connected equipment is used to control the performance. This instrument's clock is disabled. (The tempo is displayed as [J = --].)

- The Clock is set to "Int" when the power to this instrument is turned on.

5. Repeat steps 3 and 4 for the other function if desired.

MIDI PRESETS

Establish the optimum settings depending on how this instrument is connected to other equipment, and on whether this instrument is used as the master or the slave.

1. On the **MIDI** menu display, select [P7 MIDI Presets].
 - The display looks similar to the following.

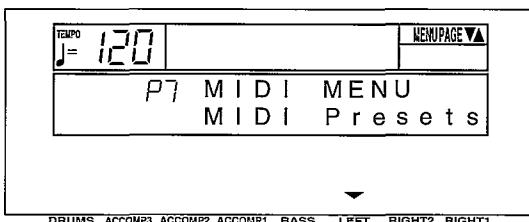

2. Press either **LEFT** button.
 - The display looks similar to the following.

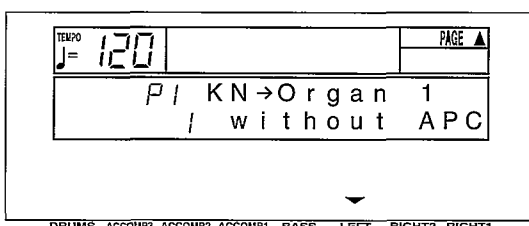

3. Use the **LEFT** ^ and v buttons to select the connection setup.

- There are two pages to this display. Use the **PAGE** buttons to change the page.
- The P1 display shows connection setups for when the **AUTO PLAY CHORD** is not used (without APC). And the P2 display shows connection setups for when the **AUTO PLAY CHORD** is used (with APC).

4. Press the **EXECUTE (SYNCHRO & BREAK)** button.

- When the settings have been successfully stored, "COMPLETED!" appears on the display.
- Detailed information about the PRESETS can be found in the separate REFERENCE GUIDE provided.

GENERAL MIDI

GENERAL MIDI (GM) is the standard which enables MIDI data exchange between different models or equipment of different manufacture. Program change numbers and their corresponding sounds, percussion instrument sounds, note numbers, etc. are data compatible between equipment using this standard.

1. On the **MIDI** menu display, select [P8 GM Mode].

- The display looks similar to the following.

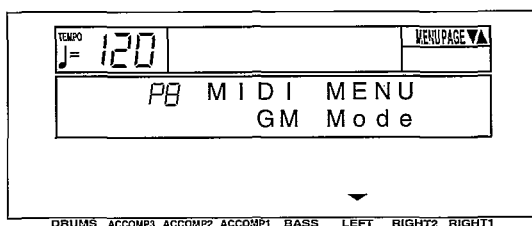

2. Press either **LEFT** button.

- The display looks similar to the following.

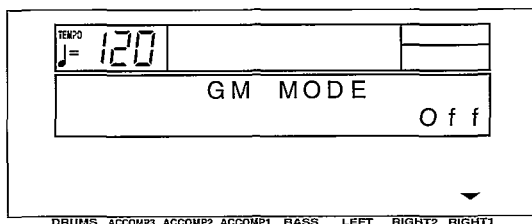

3. Use the **RIGHT 1** \wedge and \vee buttons to specify whether or not this instrument should be compatible with GENERAL MIDI standard instruments (On/Off).

- This setting is automatically set to Off when the power is turned on.
- If On is selected, the status of this instrument changes to the GENERAL MIDI status, and the sounds and operations which can be selected are limited. In addition, the arrangement of percussion sounds on the keyboard changes. (Refer to the separate REFERENCE GUIDE provided.)

4. Press the **EXECUTE (SYNCHRO & BREAK)** button.

- The display looks similar to the following.

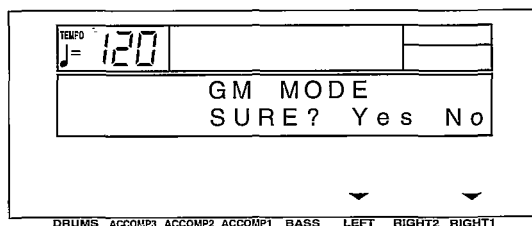

5. Press either **LEFT** (Yes) button.

- Press either **RIGHT 1** (No) button if you wish to cancel the function.
- If On was selected, the GENERAL MIDI logo is shown on the display.
- If the setting is changed from Off to On, the **SEQUENCER** memory is cleared and the panel settings are reset.
- If On is selected, this setting is automatically set to Off when the power is turned off, and all the memories are cleared. (**KN720**: The data in files that have been saved is not erased.)

BULK DUMP

This instrument's internal data can be transmitted to and received from another instrument of the same model, or other MIDI equipment with Bulk Dump capability, as SYSTEM EXCLUSIVE data.

- Sound is not generated from this instrument during this procedure.
- The operations on this display are executed, even if [RT. Sysex] is set to off on the [Common Set] display.

1. On the **MIDI** menu display select [P9 Bulk Dump].
- The display looks similar to the following.

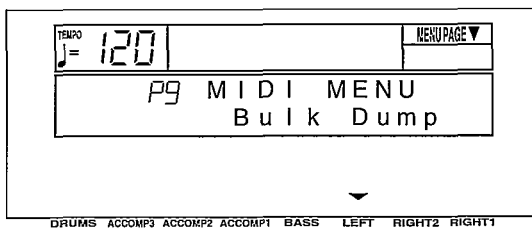

2. Press either **LEFT** button.
- The display looks similar to the following.

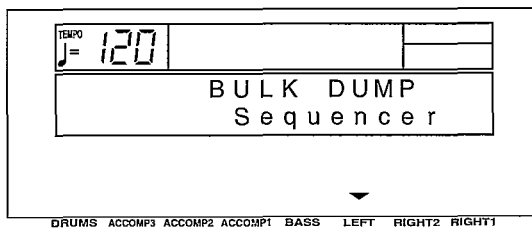

■ Transmitting

1. Follow the procedure necessary to prepare the receiving instrument for data reception.
2. Use the **LEFT** buttons to select the type of data to transmit.
 - Select from [Total] (includes all the following data), [Composer] (**KN920/KN1500**), [Sequencer], [Sound Memory] (**KN920/KN1500**), [Panel Memory], and [Manual Seq Pad] (**MANUAL SEQUENCE PADS**).
3. Press the **EXECUTE (SYNCHRO & BREAK)** button.
- The display looks similar to the following.

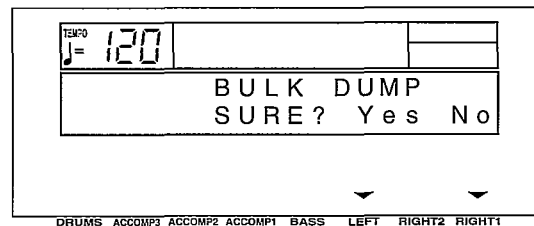

4. Press either **LEFT (Yes)** button.
 - Press either **RIGHT 1 (No)** button if you wish to cancel the procedure.
 - If the **LEFT (Yes)** button was pressed, transmission begins. During transmission, the transmitting status is shown on the display.

■ Receiving

After accessing the BULK DUMP display, follow the transmission procedure on the transmission side.

- During reception, the receiving status is shown on the display.
- If data transmission/reception is unsuccessful, an error message appears on the display.

Initialize

This instrument has many settable functions and storable memories. However, you can return the settings and memory to the factory-preset status.

INITIAL

1. Press the **MEMORY & CONTROL** button to turn it on.

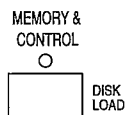

- The display changes to the following.

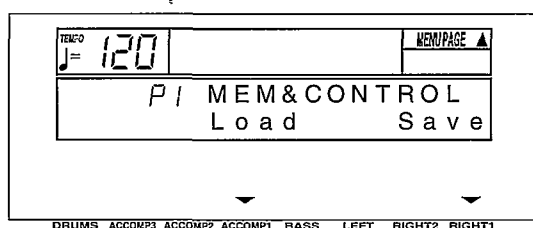

2. Use the **PAGE** ^ and v buttons to select [P2 Initial] (KN720)/[P4 Initial] (KN920/KN1500).

- This display looks similar to the following.

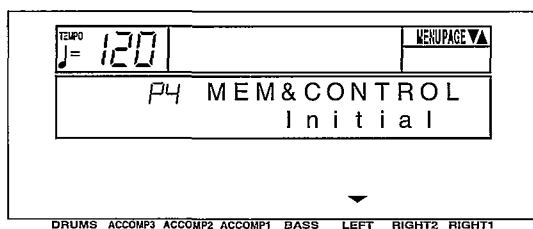

(KN920/KN1500)

3. Press either **LEFT** button.

- The display looks similar to the following.

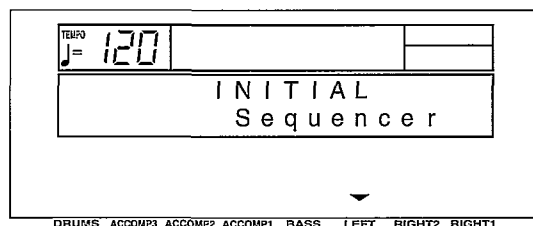

4. Use the **LEFT** ^ and v buttons to select the desired type of initialization.

- Select from [Total] (includes all the following data), [Composer] (KN920/ KN1500), [Sequencer], [Sound Memory] (KN920/KN1500), [MIDI Setting], [Panel Memory] or [Manual Seq Pad].
- The [Panel Memory] type includes the **SOUND ARRANGER** settings.

5. Press the **EXECUTE (SYNCHRO & BREAK)** button.

- The display changes to the confirmation display. Press either **LEFT** (Yes) button if you wish to execute the initialization. Press either **RIGHT 1** (No) button if you wish to cancel the procedure.

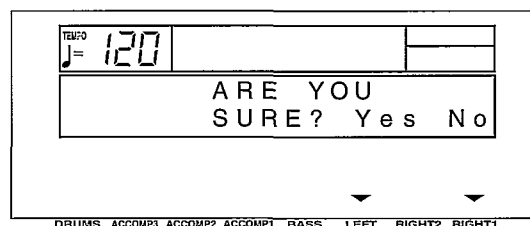

- When you press either **LEFT** (Yes) button, initialization begins. When initialization is completed, "COMPLETED!" is shown on the display and this instrument returns to the normal performance mode.

- You can also reset all the instrument settings with the following procedure: Turn off the **PLAY (KN720/KN920)/POWER (KN1500)** button once. Then, while pressing the three buttons to the right of the display (**TRANSPOSE** ^ and v, and **EXIT**) at the same time, turn the **PLAY/POWER** button on again.
- All the instrument settings may be initialized when the power is turn on, for example, if the effective time of the backup memory has been exceeded.

■ KN720/KN920: Backup memory

The various stored memories and function settings of this instrument are preserved as long as power is being supplied through the AC adaptor or the batteries. If the power supply to this instrument is discontinued (either through the AC adaptor or the batteries), the various memories and settings will be cleared after about 10 minutes.

- The backup memory does not function until the power has been on for about 10 minutes.
- **KN920:** If you wish to keep the contents of the various memories, such as the **SEQUENCER** and **COMPOSER**, before you turn off the instrument, use the SAVE procedure to store the desired data on a disk for recall at a later time. When you exit these functions without saving to a disk, a warning display appears to remind you to save the data.

■ KN1500: Backup memory

The panel settings and stored memories are maintained in a backup memory for about 10 minutes after the power to this instrument is turned off. If you wish to keep the memory contents, before you turn off the instrument, use the SAVE procedure to store the desired data on a disk for recall at a later time.

- The backup memory does not function until the power has been on for about 10 minutes.
- When you quit the operating mode, a warning display may appear to remind you to save the data.

Options

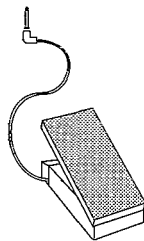

SZ-E2 (KN1500 only)
Expression Pedal

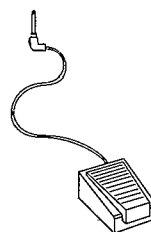

SZ-P1
Foot Switch

Connections

KN720/KN920

(Rear panel)

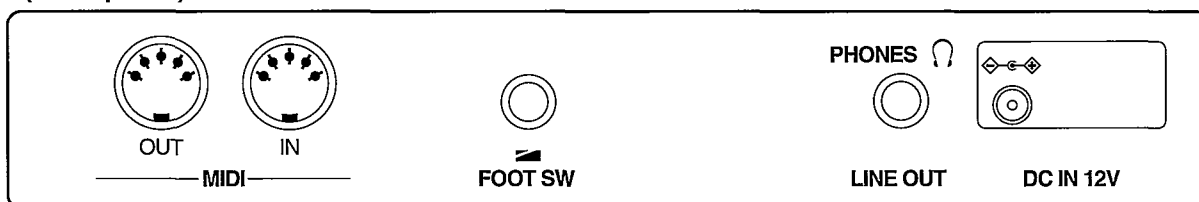

FOOT SW

An optional **SZ-P1** Foot Switch (sold separately) can be connected to this terminal to control various functions. (Refer to page 58.)

MIDI

These terminals are for connection to another MIDI instrument. (Refer to page 111.)

PHONES/LINE OUT

(output level 1.5 Vrms, 16 Ω)

Headphones, a keyboard amplifier, or stereo equipment can be connected to this terminal. When another apparatus is connected to this terminal, the speaker system is automatically switched off, and sound is heard only through the connected device.

KN1500

(Rear panel)

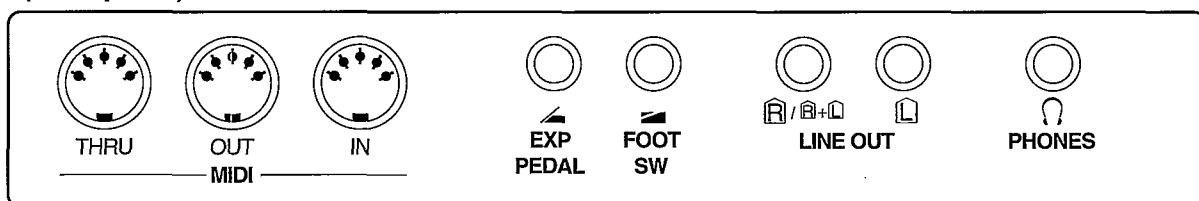

EXP PEDAL

The optional **SZ-E2** Expression Pedal (sold separately) can be connected to this terminal to control the volume.

FOOT SW

An optional **SZ-P1** Foot Switch (sold separately) can be connected to each terminal to control various functions. (Refer to page 58.)

LINE OUT (output level 1.5 Vrms, 600 Ω)

By connecting an external high-power amplifier, the sound can be reproduced at a high volume. To output monaural sound, connect the external equipment to the **R/R+L** terminal. (Do not connect the **L** terminal.)

PHONES

Headphones can be connected to this terminal. When headphones are connected to this terminal, the speaker system is automatically switched off.

MIDI

These terminals are for connection to another MIDI instrument. (Refer to page 111.)

Symptoms which appear to be signs of trouble

The following changes in performance may occur in the Technics Keyboard but do not indicate trouble.

	Phenomenon	Remedy
Sounds and effects	The buttons, keys, etc. malfunction.	<ul style="list-style-type: none"> • Turn off the PLAY (KN720/KN920)/POWER (KN1500) button once, then turn it on again. If this procedure is not successful, turn off this button once. Then, while pressing the three buttons to the right of the display (TRANSPOSE \wedge and \vee, and EXIT) at the same time, turn the PLAY/POWER button on again. (Note that, in this case, all programmable settings, functions and memories return to their factory-preset status.)
	No sound is produced when the keys are pressed.	<ul style="list-style-type: none"> • The MAIN VOLUME is at the minimum setting. Adjust the volume with the MAIN VOLUME control. • The volumes for the selected parts are set to the minimum levels. Use the balance buttons to set the volumes of the relevant parts to appropriate levels. (Refer to page 30.) • The part is muted. (Refer to page 30.) • The local control for a part performed on the keyboard is set to OFF. Set the local control to ON. (Refer to page 115.)
	Only percussive instrument sounds are produced when the keyboard is played.	<ul style="list-style-type: none"> • A sound in the KEYBOARD PERC sound group is selected.
	The volume is very low when the keyboard is played.	<ul style="list-style-type: none"> • The volume setting in the SEQUENCER contents is very low. Follow the INITIAL procedure to reset the settings. (Refer to page 122.)
	Some sounds cannot be selected.	<ul style="list-style-type: none"> • When the GENERAL MIDI status is set to on, The sounds which can be selected and operation which can be executed are limited. Turn the GENERAL MIDI status off to return the instrument to its normal operation. (Refer to page 120.)
	KN720/KN920: When using batteries, the volume level becomes low or the sound is distorted.	<ul style="list-style-type: none"> • The batteries are low. Replace all the batteries with new ones as soon as possible.
	KN920/KN1500: The sound you hear is different from the sound you selected.	<ul style="list-style-type: none"> • This sometimes occurs when you play back SEQUENCER or COMPOSER data which was created on a different model, or when MIDI data is received from a connected instrument. Select the desired sounds again.
	Rhythm	The rhythm does not start.

Phenomenon		Remedy
AUTO PLAY CHORD	No sound is produced for the automatic accompaniment.	<ul style="list-style-type: none"> • KN920/KN1500: A rhythm in COMPOSER memory with no stored pattern was selected. Select a different rhythm.
	No sound is produced for the automatic accompaniment, or only the sounds of some parts are produced.	<ul style="list-style-type: none"> • An ACCOMP part does not sound if its corresponding volume is set to the minimum level. Use the respective balance buttons to set the ACCOMP 1, 2 and 3 volumes to appropriate levels.
SEQUENCER	Storage is not possible.	<ul style="list-style-type: none"> • The remaining memory capacity of the SEQUENCER is 0. Follow the SONG CLEAR or TRACK CLEAR procedure to erase the memory. (Refer to pages 73 and 74.)
	Multi-track storage is not possible.	<ul style="list-style-type: none"> • The playback track has been selected, but the START/STOP button has not been pressed. On the recording display, the track marked with a horizontal bar in the REC row is the track which is ready for recording; a track marked with a horizontal bar in the PLAY row is a track which is ready for playback. To record one track while listening to another (playback) track, press the START/STOP button to begin playback.
	The playback measure indication is different from when the performance was recorded.	<ul style="list-style-type: none"> • The number of measures corresponds to the time signature of the rhythm selected at the start of recording. To change the rhythm in the middle of the song, record the rhythm change in the RHYTHM part. (Refer to page 71.)
COMPOSER (KN920/KN1500)	Storage is not possible.	<ul style="list-style-type: none"> • The remaining memory capacity of the COMPOSER is 0.
	Setting the time signature and number of measures is not possible.	<ul style="list-style-type: none"> • The time signature and number of measures cannot be changed for a pattern which is currently recorded in the COMPOSER. If you wish to change the time signature and/or measure data, first follow the procedure to clear the memory. (Refer to page 81.)
	The playback timing of the rhythm pattern is different from the timing with which it was recorded.	<ul style="list-style-type: none"> • The QUANTIZE function was on when the pattern was recorded and the timing was automatically corrected. Set the quantize level to a smaller note unit or to OFF when recording. (Refer to page 83.)
Disk Drive (KN920/KN1500)	The Disk Drive produces a noise during recording or playback.	<ul style="list-style-type: none"> • This occurs when the Disk Drive is reading a disk. It does not indicate a problem.
	When the procedure to load from a disk is performed, the contents of the keyboard memory are erased.	<ul style="list-style-type: none"> • When performing the load operation from a disk, the keyboard memory changes to that of the data loaded from the disk. If you wish to preserve a song which is stored in the keyboard memory, save it on a disk before performing the load procedure. (Refer to page 97.)
Other	Noise from a radio or TV can be heard.	<ul style="list-style-type: none"> • This sometimes occurs when electrical equipment such as a radio or TV is used near the instrument. Try moving such electrical equipment further away from the instrument. • The sound may be coming from a nearby broadcast station or amateur radio station. If the sound is bothersome, consult your dealer or service center.
	The cabinet becomes warm during use.	<ul style="list-style-type: none"> • This instrument has a built-in power source that heats the cabinet to some degree. This is not an indication of trouble.

Error messages

Display		Contents
00	WRONG DISK!	The data on the disk that you are using is for a different product. (KN920/KN1500)
01	LOAD ERROR TRY AGAIN!	An error has occurred while the disk was loading. Please try again.
02	NO DISK!	There is no disk in the Disk Drive. (KN920/KN1500)
03	FILE EMPTY!	The file that you tried to load is empty. (KN920/KN1500)
04	SAVE ERROR TRY AGAIN!	An error has occurred while the data was being saved. Please try again.
05	WRITE PROTECTED!	The disk that you are using is write protected. Please remove the write protection and try again. (KN920/KN1500)
06	FILE FULL!	The internal memory is full. Please clear unwanted files. (KN720)
	DISK FULL!	The disk that you are using is full. Please use another disk. (KN920/KN1500)
07	FORMAT ERROR TRY AGAIN!	An error has occurred while the disk was formatting. The disk that you are using may be faulty. Please try formatting another disk. (KN920/KN1500)
08	DATA IS COPY PROTECTED!	The data on this disk is copy protected. (KN920/KN1500)
09	ALREADY COPY PROTECTED!	The data on this disk is already copy protected. (KN920/KN1500)
11	SEQUENCER DATA ERROR!	There is an error in the SEQUENCER data. Playback is not possible.
12	MEMORY FULL!	The memory is full. No more data can be recorded.
13	CHANGE IMPOSSIBLE!	It is not possible to change the time signature of a COMPOSER pattern after it has been recorded. If you want to proceed, you must first clear the entire COMPOSER pattern. (KN920/KN1500)
14	TIME SIG MISMATCH!	The time signature of the pattern from which you are copying is different from the COMPOSER memory that you are using. Either: Change the time signature of the COMPOSER memory or: Copy from a pattern that has the same time signature. (KN920/KN1500)
15	TIME SIG ALREADY SET	The time signature has already been set. It cannot be changed.
16	TRACK EXISTS!	The specified track already exists. It is impossible to assign two tracks to that part.
17	FILE TOO LONG!	This song is too long to be saved as an SMF file. (KN920/KN1500)
18	SMF LOAD ERROR!	The SMF file that you tried to load exceeds the memory capacity of this instrument and cannot be loaded. The destination SEQUENCER memory has been cleared. (KN920/KN1500)
19	BULK DUMP SEND ERROR!	An error occurred during system exclusive transmission. The data was not transmitted successfully. Please try again.
20	BULK DUMP RECV ERROR!	An error occurred during system exclusive data reception. The data was not received successfully. Please try again.
21	BULK DUMP ID CODE ERR!	The Identification (ID) code of the system exclusive data received by this instrument is for a different product.
22	"ALL" OPTION ONLY AVAIL	To load data which was saved on an older model Technics instrument, set the load option to "ALL." (KN920/KN1500)

Display		Contents
23	NO SEQUENCER DATA!	There is no data in the SEQUENCER .
24	SMF CONVERT ERROR!	An error occurred in the SMF conversion. (KN920/KN1500)
25	NOT STANDARD MIDI FILE!	This disk is not in the Standard MIDI File data format. (KN920/KN1500)
26	SMF CONVERT ERROR!	SMF conversion is possible only for files with a time base (PPQ resolution) of 24/48/96/192/288/384. (KN920/KN1500)
27	SMF FORMAT ERROR!	FORMAT 2, 3, 4 ... SMF data cannot be used. (KN920/KN1500)
28	RHYTHM & CHORD ONLY!	Step record can be activated only for tracks to which the RHYTHM or CHORD part has been assigned.
29	SELECT A PRESET PTN!	A COMPOSER rhythm cannot be selected for the SOUND ARRANGER . Please select a preset rhythm. (KN920/KN1500)
30	SELECT A USER BANK!	Please select Bank "13 User" to store in the MANUAL SEQUENCE PADS .
31	TRACK ASSIGN MISMATCH!	Special tracks such as CHORD/APC, RHYTHM and CONTROL exist in the song from which you are copying and are incompatible with the destination song because it is in the GM mode.
32	MEAS/T. SIG MISMATCH!	The COMPOSER pattern you have chosen has a different time signature or number of measures from the other patterns in this COMPOSER CHORD MAP . All of the COMPOSER patterns used in a COMPOSER CHORD MAP must have the same time signature and number of measures. (KN920/KN1500)
33	NOT ENOUGH AVAIL MEMORY	The song that you have tried to load exceeds the this instrument's available memory and cannot be loaded. The selected SEQUENCER song memory has been cleared. Please clear existing songs in the instrument's memory using SONG CLEAR to make more memory available, and try again. (KN920/KN1500)
34	THIS FILE IS SMF FORMAT1!	This is an SMF FORMAT 1 file. Direct Play and Sequencer Medley are not available for this file. (KN920/KN1500)
35	RHYTHM DATA ERROR!	There is an error in the rhythm data. Playback is not possible.
36	MSP DATA ERROR!	There is an error in the MANUAL SEQUENCE PADS data. Playback is not possible.
37	DRUM EDIT IMPOSSIBLE!	The DRUM sounds cannot be edited with the SOUND EDIT . (KN920/KN1500)
38	NO CHORD TRACK!	[Chord] was selected in the Step record mode of the SEQUENCER , but there is no track to which the [Chord] part has been assigned.
39	NO RHYTHM TRACK!	[Rhythm] was selected in the Step record mode of the SEQUENCER , but there is no track to which the [Rhythm] part has been assigned.
	WARNING! LOW BATTERIES!	The remaining battery power is very low. Replace all the batteries with new ones immediately. (KN720/KN920)

Index

A

APC CONTROL, MIDI	116
AUTO PLAY CHORD	49
AUTO PLAY CHORD INPUT, MIDI	118
AUTO PLAY CHORD OUTPUT, MIDI	118

B

Backup memory	123
BALANCE	30
BANK	56
BASIC CHANNEL, MIDI	114
BEAT	47
BEND RANGE	84
BULK DUMP	121

C

CHORUS	38
CLOCK, MIDI	119
COMMON SETTING, MIDI	116
COMPOSER	77
COMPOSER CHORD MAP	85
COMPOSER COPY	79
CONDUCTOR	36
Connections	124
CONTRAST	34
CONTROL MESSAGE, MIDI	117
COUNT INTRO	48

D

DEMO	16
DIGITAL EFFECT	38
DIGITAL REVERB	40
DIRECT PLAY	95
Disk Drive	89
DISK LOAD	91
DISK SAVE	97
Display	30
DISPLAY HOLD	33
DRUMS OUTPUT, MIDI	118
DRUMS TYPE, MIDI	116
DSP EFFECT	39

E

EASY RECORD	62
EDIT, SEQUENCER	73
ENDING	49
ENVELOPE	110
Error messages	127
EXIT	33
EXP PEDAL	124
Expression Pedal	123

F

FILL IN	48
FINGERED	50
FLOPPY DISK FORMAT	96

FOOT SW	124
Foot Switch	123
FOOT SWITCH SETTING	58

G

GENERAL MIDI (GM)	120
GLIDE	58

H

Headphones	124
------------	-----

I

INITIAL	122
INPUT/OUTPUT SETTING, MIDI	118
INST ERASE	83
INTRO & ENDING	48
INTRO, MIDI	116

K

KEY SCALING	104
KEY SHIFT	102
KEYBOARD PERC	35

L

LEFT HOLD	105
LINE OUT	124
LOAD SINGLE COMPOSER PATTERN	93
LOAD SINGLE SOUND MEMORY	94
LOCAL CONTROL, MIDI	115

M

MAIN VOLUME	13, 15
MANUAL SEQUENCE PADS	44
MASTER TUNING	103
MEASURE & TIME SIGNATURE	81
MEMORY, AUTO PLAY CHORD	50
MEMORY & CONTROL	90
MENU	32
Metronome	64
MIDI	111
MIDI PRESETS	119
MIDI SETUP LOAD	116
MODULATION	41
Music stand	12, 14
MUSIC STYLE SELECT	54
MUSIC STYLE ARRANGER	55
MUTE	30

N

NOTE ONLY, MIDI	116
-----------------	-----

O

OCTAVE SHIFT, MIDI	115
ON BASS	50
ONE FINGER	50
ONE TOUCH PLAY	53

Options	123
OTHER PARTS/TRACKS	31

P

PAGE	31
PAN	102
PANEL MEMORY	56
PART SETTING	102
PIANIST	50
PITCH	109
PITCH BEND	40
PITCH BEND RANGE	102
PLAY	13
POWER	15
PROGRAM CHANGE MODE, MIDI	116

Q

QUANTIZE, COMPOSER	83
QUANTIZE, SEQUENCER	74

R

REALTIME COMMANDS, MIDI	119
REALTIME RECORD	64
REALTIME SYSEX, MIDI	116
RECORD/STOP	44
RHYTHM	46
RIGHT 1 INPUT, MIDI	118

S

SELECT	44
SET	56
SEQUENCER	59
SEQUENCER EDIT	73
SEQUENCER MEDLEY	76
SEQUENCER PLAY	66
SEQUENCER RESET	66
SMF LOAD	93
SMF SAVE	99
SONG CLEAR	73
SONG SELECT/NAME	61
SOUND/PART	35
SOUND ARRANGER	52
SOUND EDIT	106
SOUND MEMORY	107
SOUND SETTING	101
Specifications	131
SPLIT POINT	37
Standard MIDI File (SMF)	89
START/STOP	47, 67
STEP RECORD: CHORD	68
STEP RECORD: RHYTHM	71
SUSTAIN	39
SYNCHRO & BREAK	47, 51

T

TAP TEMPO	47
TECHNI-CHORD	42
TECHNI-CHORD OUTPUT, MIDI	118
TECHNI-CHORD TYPE	43
TEMPO	47

TEMPO/PROGRAM	47
TONE	106
TONE SELECT	108
TOUCH & TUNE	103
TRACK ASSIGN	72
TRACK CLEAR	74
TRANSPOSE	41
Troubleshooting	125
TUNING	103

V

VARIATION	46
VARIATION & MSA	46
VOLUME	102
Volume balance	30

W

WRITE	107
-------------	-----

Specifications

	SX-KN720	SX-KN920	SX-KN1500
KEYBOARD	61 KEYS (WITH INITIAL TOUCH)		
SOUND GENERATOR	PCM		
MAXIMUM NUMBER OF NOTES PRODUCED SIMULTANEOUSLY	32 NOTES		
SOUNDS	150 SOUNDS	200 SOUNDS	
DIGITAL REVERB	○		
DIGITAL EFFECT	○		
DSP EFFECT	—	○	
CHORUS	○	—	
SUSTAIN	○		
SOUND EDIT	—	○ (MEMORY: 40)	
TRANPOSE	G-C-F [♯]		
RHYTHM	128 × 2 VARIATIONS	128 × 4 VARIATIONS	
RHYTHM CONTROLS	START/STOP, INTRO & ENDING, FILL IN 1, 2, COUNT INTRO, SYNCHRO & BREAK, TEMPO	START/STOP, INTRO & ENDING 1, 2, FILL IN 1, 2, COUNT INTRO, SYNCHRO & BREAK, TEMPO	START/STOP, INTRO & ENDING 1, 2, FILL IN 1, 2, COUNT INTRO, SYNCHRO & BREAK, TEMPO, TEMPO/PROGRAM DIAL, TAP TEMPO
MANUAL SEQUENCE PADS	12 BANKS × 4 PADS, 1 USER BANK: 1200 NOTES, RECORD/STOP	12 BANKS × 6 PADS, 1 USER BANK: 1200 NOTES, RECORD/STOP	
AUTO PLAY CHORD	MODE: ONE FINGER, FINGERED, PIANIST MEMORY, ON BASS		
MUSIC STYLE ARRANGER	—	○	
SOUND ARRANGER	○		
ONE TOUCH PLAY	○		
MUSIC STYLE SELECT	—	○	
TECHNI-CHORD	○		
PANEL MEMORY	10	2 BANKS × 5, SET	
SEQUENCER	16 TRACKS, 10 SONGS RESOLUTION: STORAGE CAPACITY: RECORD MODES: FUNCTIONS:	96 PULSES PER QUARTER-NOTE APPROX. 10000 NOTES (KN720)/ APPROX. 30000 NOTES (KN920/KN1500) EASY, REALTIME, STEP (CHORD, RHYTHM) TRACK ASSIGN, EDIT, SONG SELECT/NAME, MEDLEY	
COMPOSER	—	5 PARTS: STORAGE CAPACITY: FUNCTIONS: MEMORY:	BASS, ACCOMP 1, 2, 3, DRUMS APPROX. 10000 NOTES BEND RANGE, MODE SELECT, PATTERN COPY, SINGLE LOAD, CHORD MAP 3 BANKS × 10 (VARIATION 1-4, INTRO 1, 2, FILL IN 1, 2, ENDING 1, 2)
MEMORY & CONTROL	INITIAL, FOOT SWITCH SET, LOAD, SAVE, CONTRAST	INITIAL, FOOT SWITCH SET, DIRECT PLAY, DISK LOAD, DISK SAVE, DISK FORMAT, CONTRAST	
SOUND SETTING	PART SETTING, KEY SCALING, TOUCH & TUNE, LEFT HOLD		
MIDI	CHANNEL, PART SETTING, COMMON SET, CONTROL MESSAGE, IN/OUT SET, REALTIME MESSAGE, MIDI PRESETS, GM MODE, BULK DUMP		
DISK DRIVE	—	BUILT-IN 3.5 INCH FLOPPY DISK DRIVE FOR 2HD (1.44 MB), 2DD (720 KB)	

	SX-KN720	SX-KN920	SX-KN1500
PITCH BEND WHEEL	○		
MODULATION WHEEL	—		○
OTHER CONTROLS	MAIN VOLUME, BALANCE, MUTE, SPLIT POINT, CONDUCTOR		
DISPLAY	LCD (PAGE, EXIT, DISPLAY HOLD)		
DEMO	○		
TERMINALS	DC IN 12V, PHONES/LINE OUT, FOOT SW, MIDI (IN, OUT)	PHONES, LINE OUT (R/R+L, L), FOOT SW, EXP PEDAL, MIDI (IN, OUT, THRU)	
OUTPUT	1.5 W × 2 (WITH BATTERIES), 8 W × 2 (WITH SY-AD6/AD6B AC ADAPTOR)	15 W × 2	
SPEAKERS	12 cm × 2	12 cm × 2, 6.5 cm × 2	
POWER REQUIREMENT	BATTERIES: DC 9V (USING R20/LR20 ["D" SIZE, UM-1] BATTERIES × 6)	90 W, 60 W (NORTH AMERICA AND MEXICO)	
	AC: WITH SY-AD6 AC ADAPTOR AC 120/220/230/240V 50/60Hz AC 120V 60Hz (NORTH AMERICA AND MEXICO)	AC 120/220/240V 50/60Hz AC 120V 60Hz (NORTH AMERICA AND MEXICO)	
	AC: WITH SY-AD6B AC ADAPTOR AC 230V 50/60Hz (EUROPE EXCEPT FOR UNITED KINGDOM)	AC 230-240V 50/60Hz (EUROPE, AUSTRALIA, NEW ZEALAND, SINGAPORE AND PHILIPPINES)	
DIMENSIONS (W×H×D)*	105.7 cm × 14.9 cm × 40.4 cm (41-5/8" × 5-7/8" × 15-29/32")		
NET WEIGHT*	8.3 kg (18.3 lbs.)	8.8 kg (19.4 lbs.)	10.8 kg (23.8 lbs.)
ACCESSORIES	MUSIC STAND		MUSIC STAND, AC CORD

* Without MUSIC STAND, BATTERIES

• Design and specifications are subject to change without notice.

976