

Roland Synthesizer

SYSTEM 100

AUDIO MIXER

MODEL **103**

INSTRUCTION MANUAL

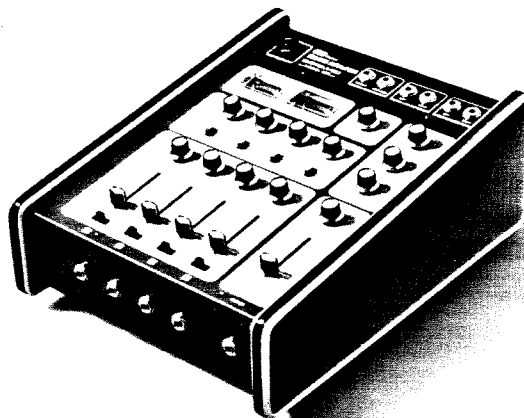

Roland

CONTENTS

INTRODUCTION	3
1. THE CONTROLS	4
2. USING THE MIXER	13
2-1-0 Signal-to-noise ratio	13
2-2-0 Using the Mixer controls	15
2-3-0 The VU meters	17
3. RECORDING WITH A FOUR CHANNEL TAPE DECK	19
3-1-0 Preliminaries	19
3-2-0 Recording	21
3-3-0 Mixing down	23
3-4-0 Adding more voices	24
3-5-0 The four channel tape deck alone	26
4. CAUTIONS	28
4-1-0 The reverberation unit	28
4-2-0 The PAN POTs	28
4-3-0 False stereo	28
THE LAST WORD	29
SPECIFICATIONS	30
INDEX TO TERMS	31

Copyright © 1976 by ROLAND CORPORATION

All rights reserved. No part of this publication may be reproduced in any form without prior written permission of ROLAND CORPORATION.

INTRODUCTION

Although it is designed as a part of the ROLAND System 100, the Model 103 Audio Mixer can be used in almost any situation where a four channel mixer is needed.

A glance at the front panel will show that the operation of the Model 103 Audio Mixer doesn't present many problems, so this manual has been divided into three main sections.

Section 1 is a brief description of the controls and their function.

Section 2 contains a few more details on certain points.

Section 3 gives a few notes on using the 103 Mixer in conjunction with a four channel tape deck for making synthesizer tapes.



W. W. Keown

1. THE CONTROLS

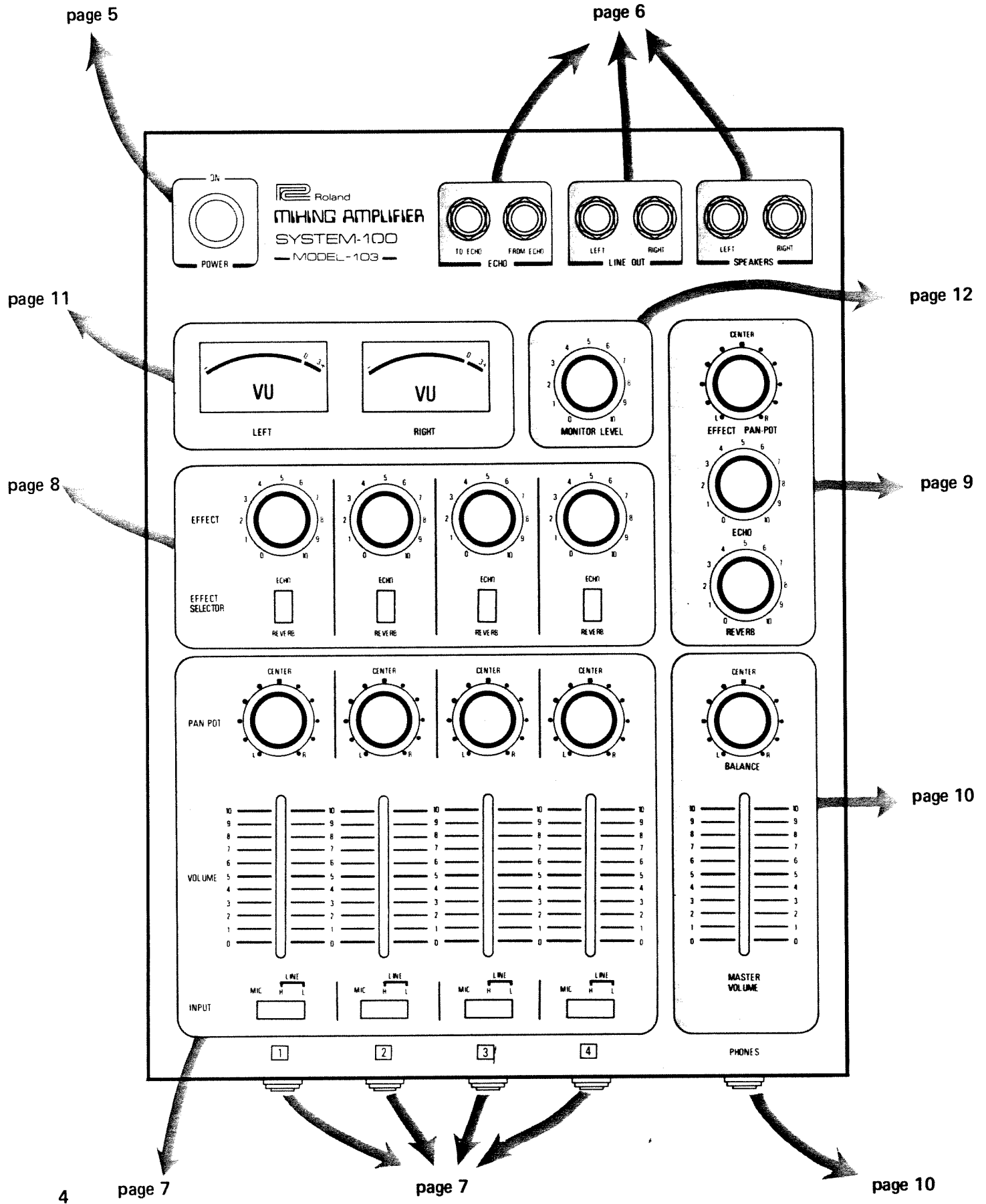

The POWER switch

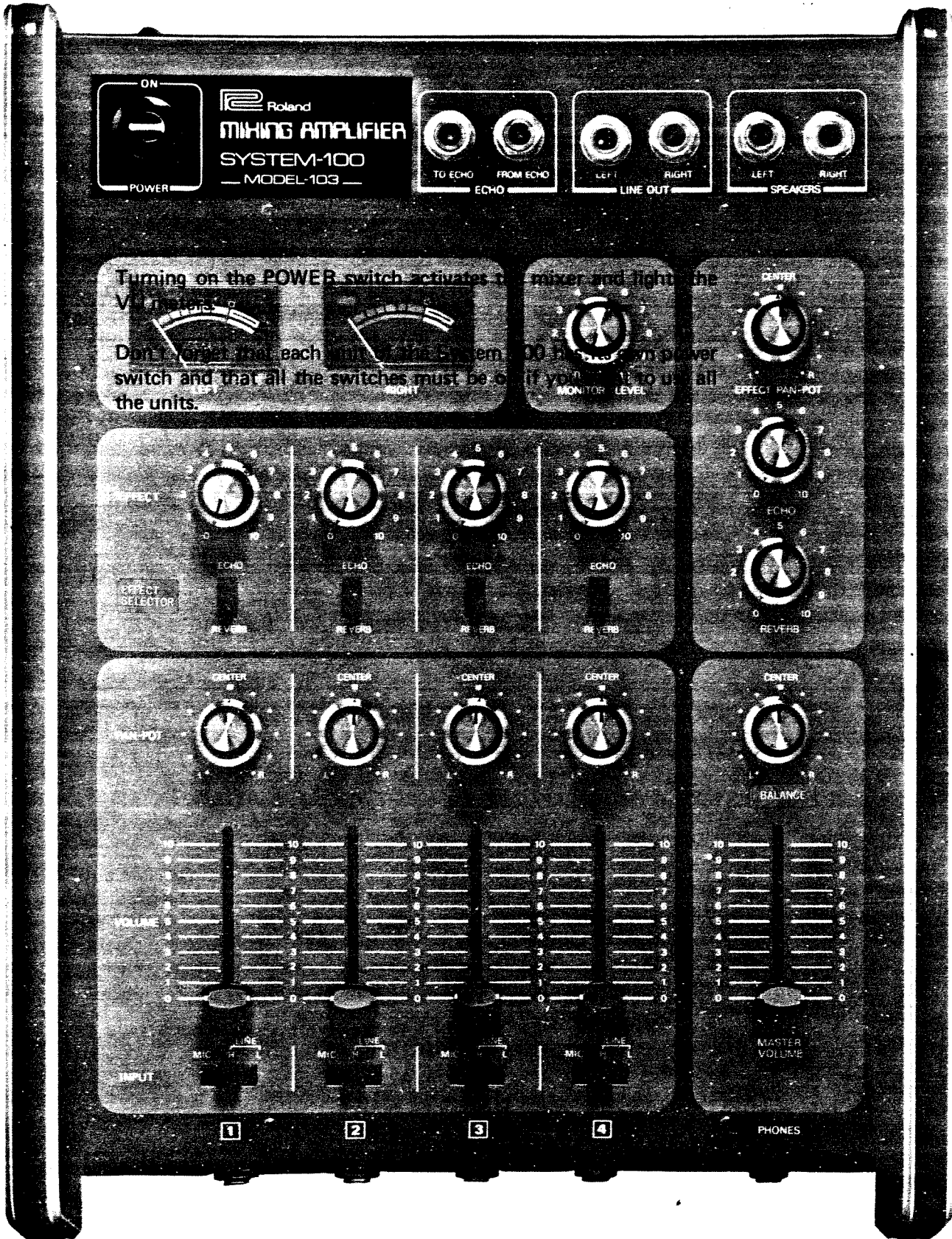

Turning on the POWER switch activates the mixer and lights the VU meters. Don't forget that each unit of the System-100 has its own power switch and that all the switches must be on for the units. If you want to use all

The Output Jacks

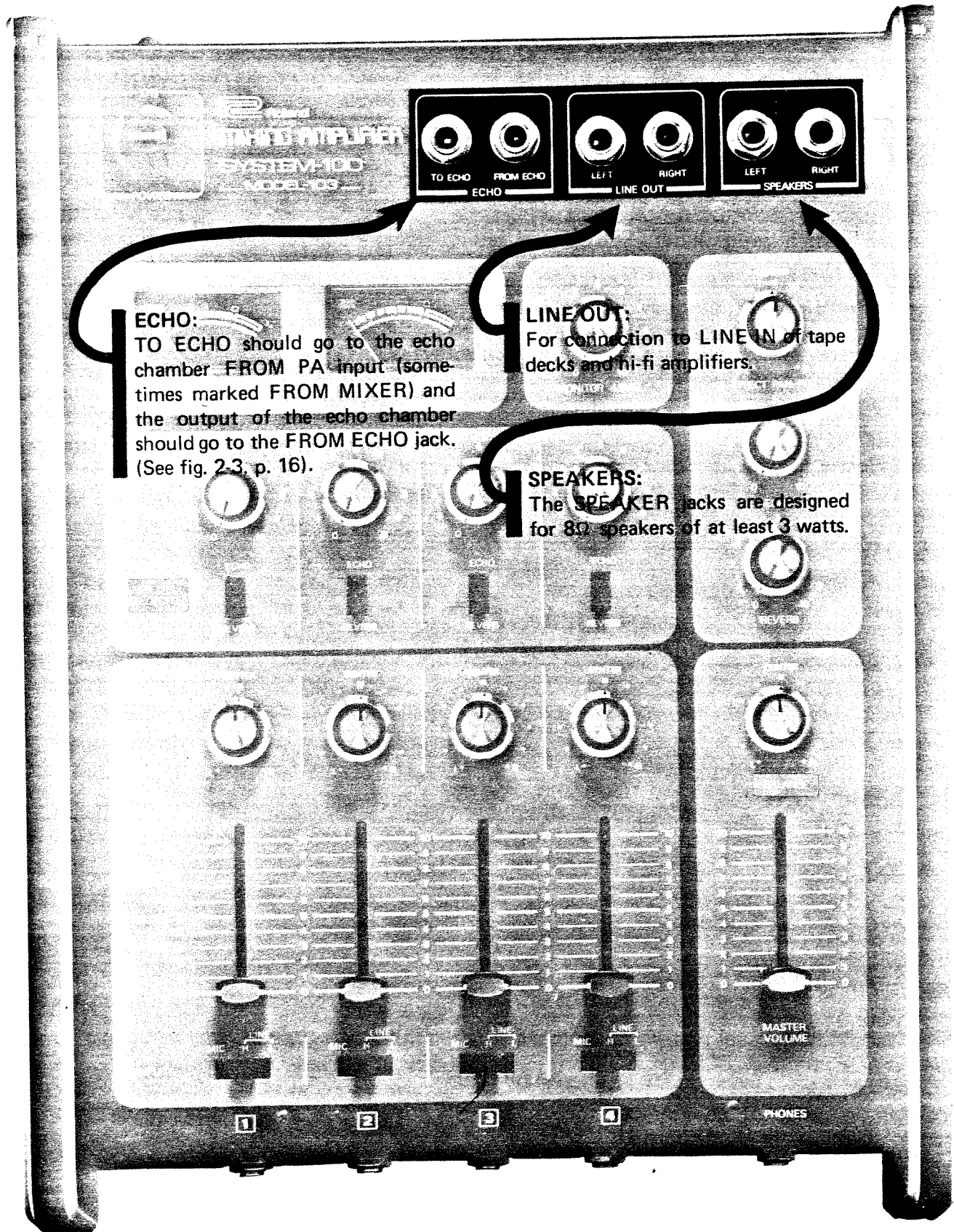

ECHO:
TO ECHO should go to the echo chamber FROM PA input (sometimes marked FROM MIXER) and the output of the echo chamber should go to the FROM ECHO jack. (See fig. 2-3, p. 16).

LINE OUT:
For connection to LINE IN of tape decks and hi-fi amplifiers.

SPEAKERS:
The SPEAKER jacks are designed for 8Ω speakers of at least 3 watts.

The INPUT section

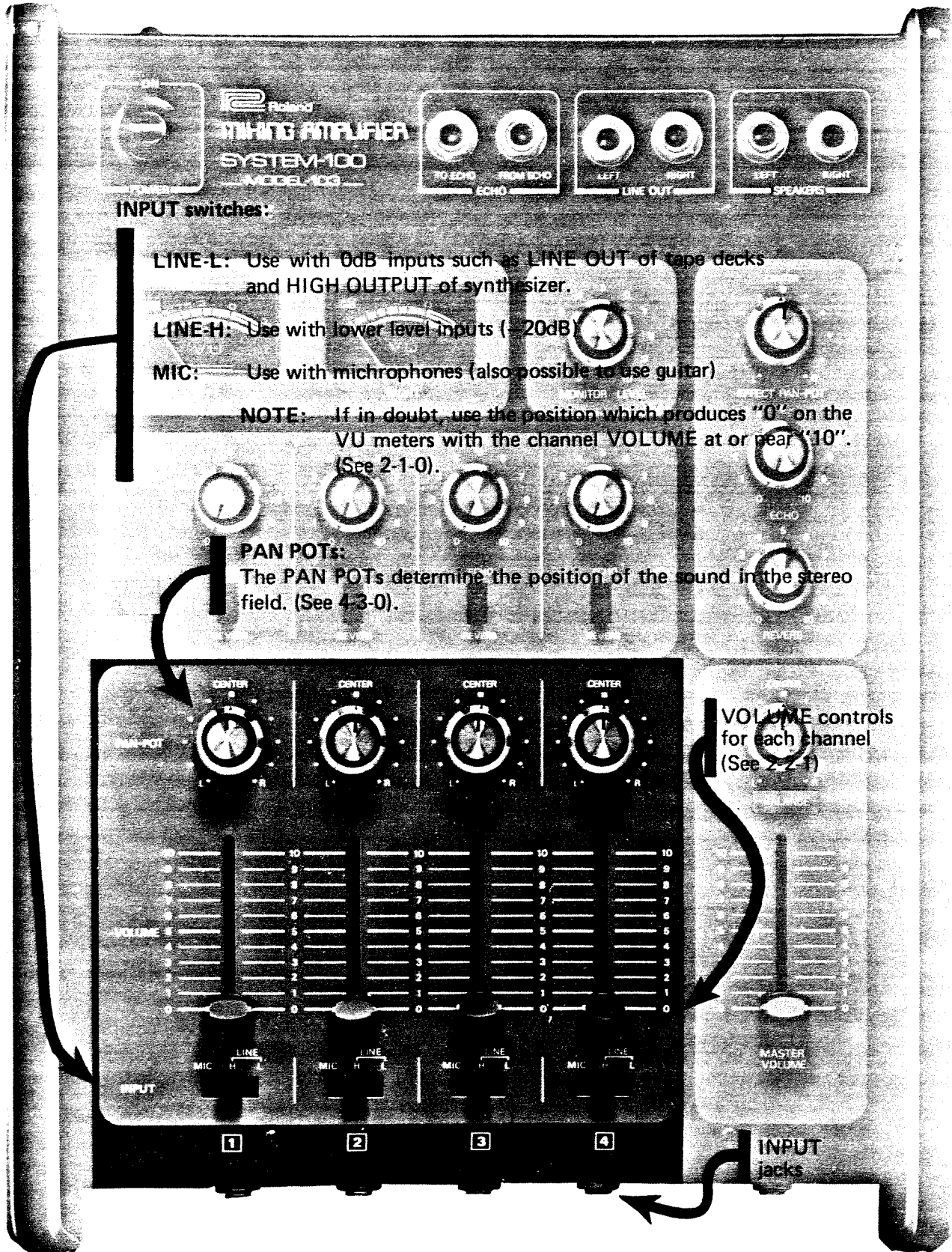

INPUT switches:

LINE-L: Use with 0dB inputs such as LINE OUT of tape decks and HIGH OUTPUT of synthesizer.

LINE-H: Use with lower level inputs (-20dB)

MIC: Use with microphones (also possible to use guitar)

NOTE: If in doubt, use the position which produces "0" on the VU meters with the channel VOLUME at or near "10". (See 2-1-0).

PAN POTs:

The PAN POTs determine the position of the sound in the stereo field. (See 4-3-0).

VOLUME controls for each channel
(See 2-2-1)

INPUT jacks

The EFFECTS INPUT section

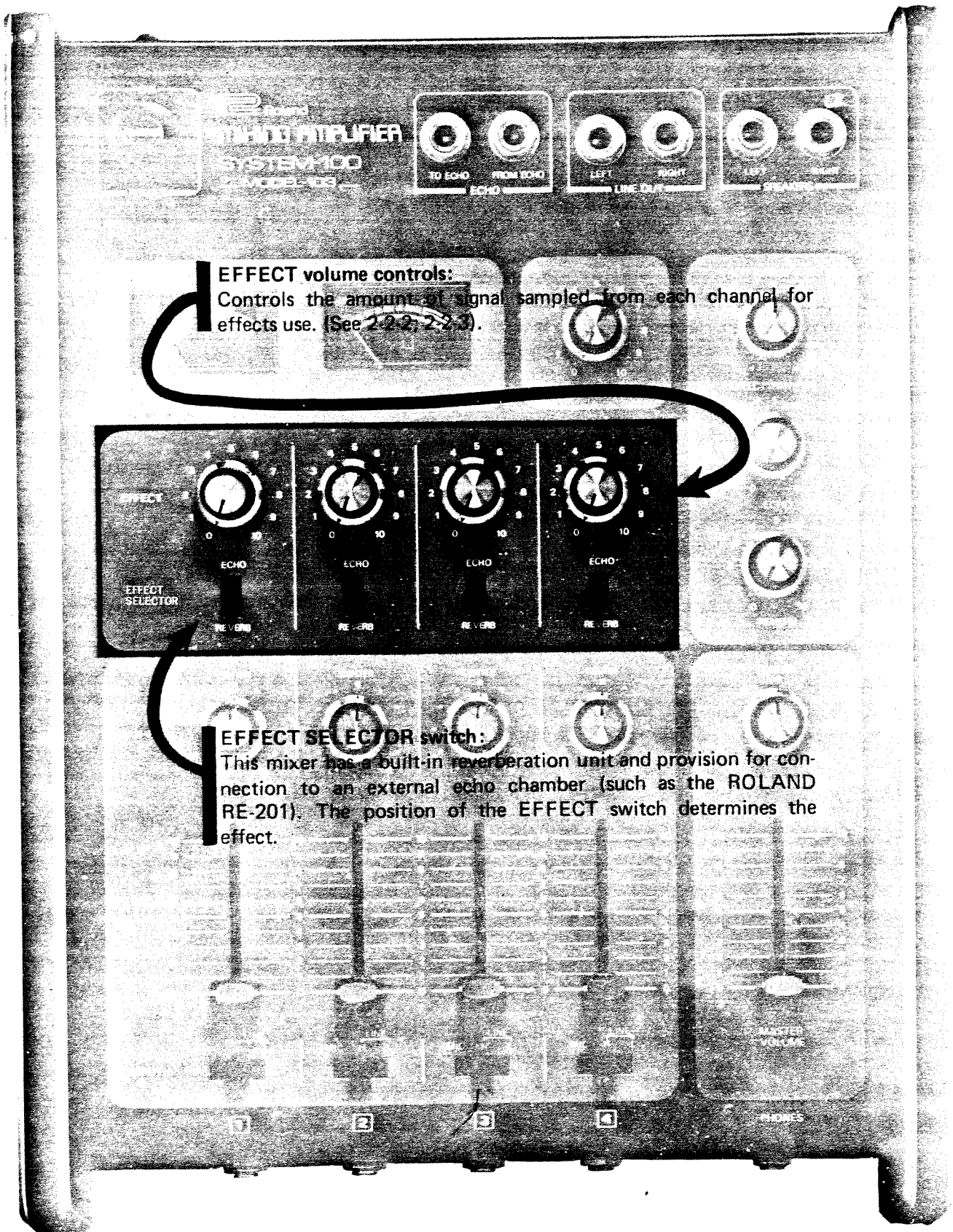

The EFFECTS OUTPUT section

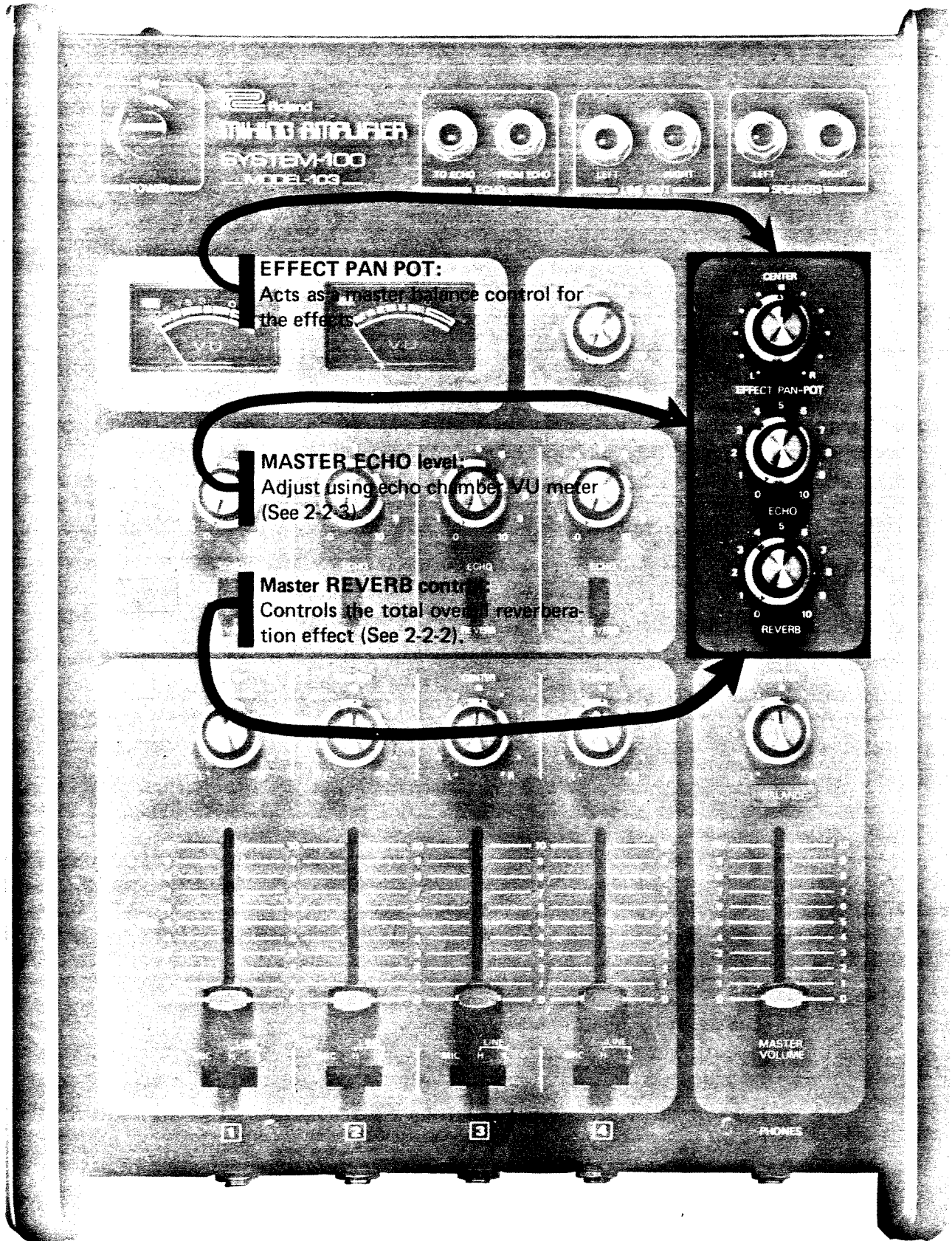

The OUTPUT section

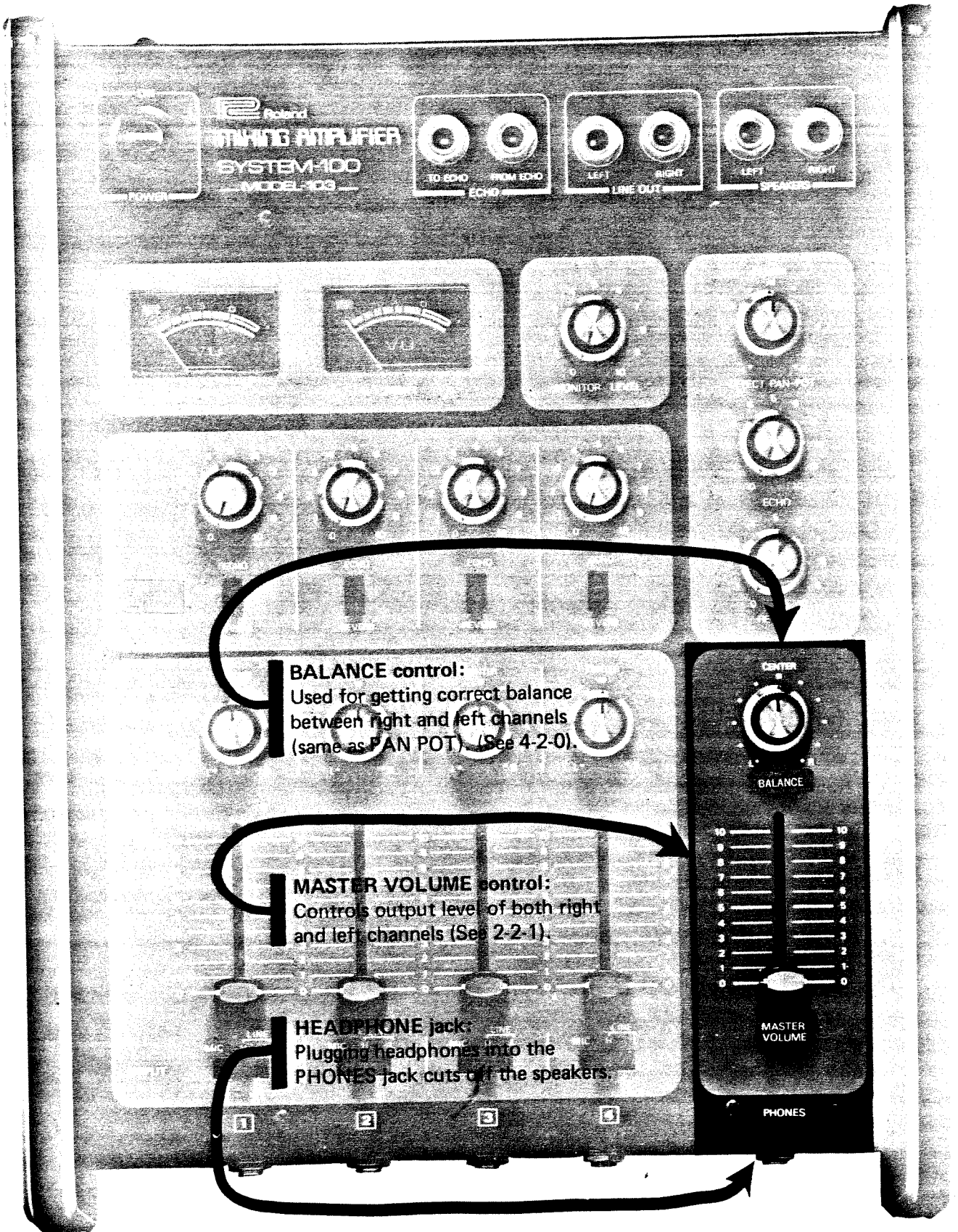

BALANCE control:
Used for getting correct balance between right and left channels (same as PAN POT). (See 4-2-0).

MASTER VOLUME control:
Controls output level of both right and left channels (See 2-2-1).

HEADPHONE jack:
Plugging headphones into the PHONES jack cuts off the speakers.

The VU meters

The VU meters show the average amplitude of the output signals for each channel. The meters light when the mixer is receiving power. (See 2-3-0).

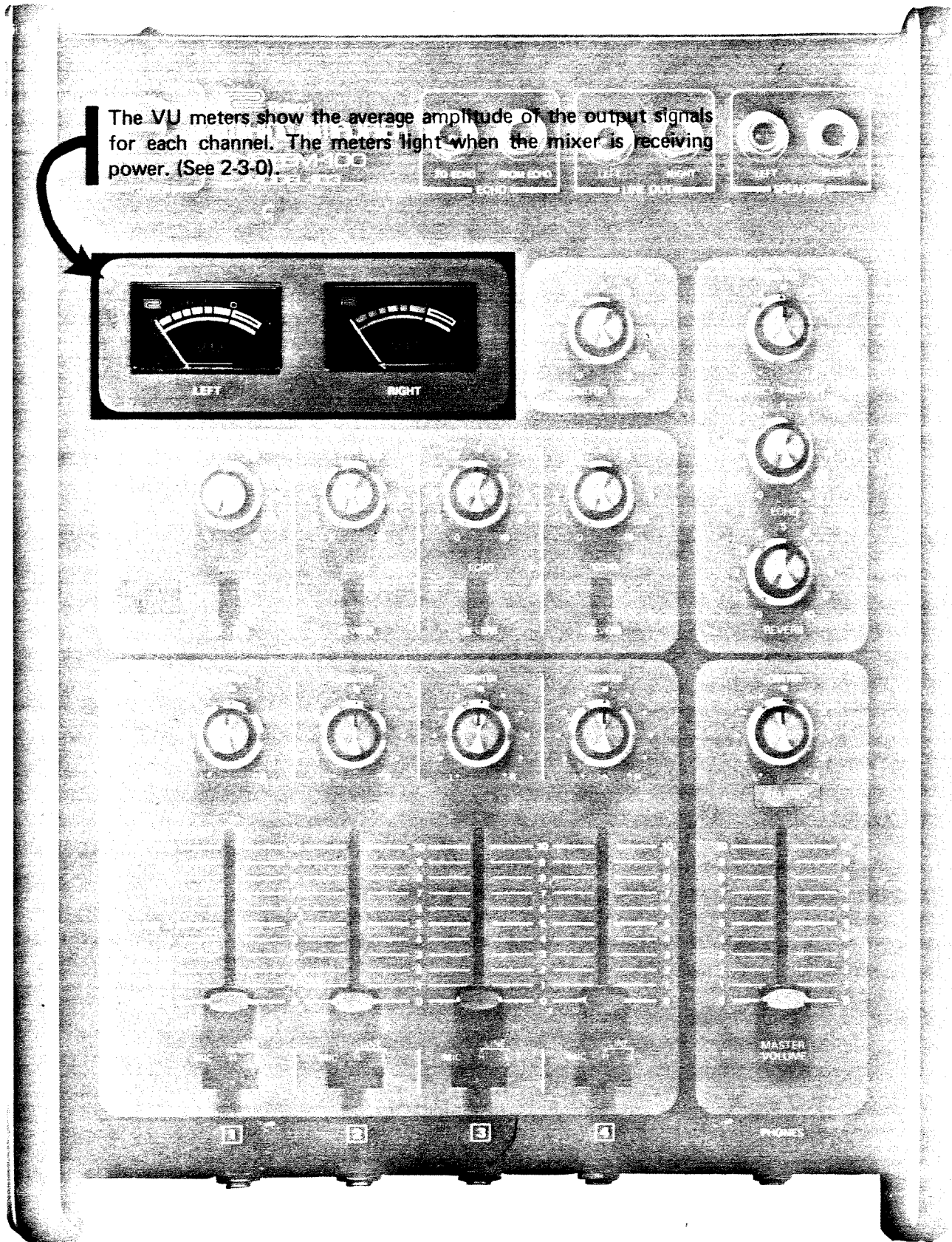

The MONITOR LEVEL

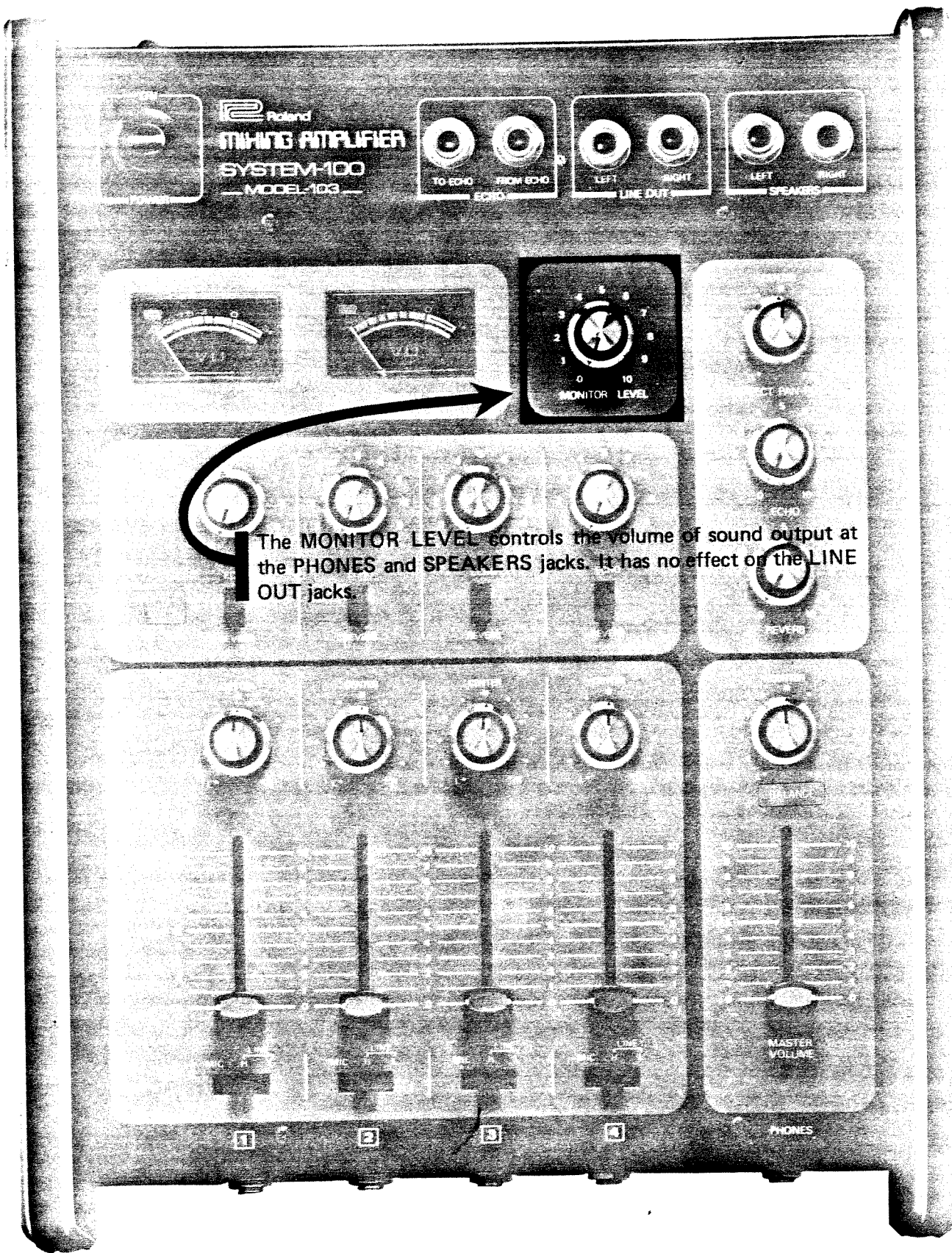

The MONITOR LEVEL controls the volume of sound output at the PHONES and SPEAKERS jacks. It has no effect on the LINE OUT jacks.

2. USING THE MIXER

The following are some points which will help you get more out of your mixer and related equipment.

2-1-0	Signal-to-noise ratio
-------	------------------------------

All electronic equipment generates a certain amount of noise. This noise, highly amplified, is the source of noise in the NOISE GENERATOR.

Electronic circuits are also designed to take a certain level of signal (sound, in the case of audio equipment) with a minimum of distortion. For ease in calculations, this level is called "0" (zero). This is the meaning of the "0" on VU meters.

Values above this "0" are "+" (plus) values (usually red on VU meters), and values below are "-" (minus) values. These values are measured in units called decibels (dB). (The bel is named after Alexander Graham Bell of telephone fame).

The signal-to-noise (S/N) ratio for the Model 103 Audio Mixer is: "more than 60dB" (SPECIFICATIONS, P. 30). (Sometimes S/N is expressed as a negative value: -60dB, but the meaning is the same). This means that the level of the noise generated by the circuits is lower than -60dB in relation to the "0" reference level.

A S/N value of 50dB would be considered from fair to good in hi-fi equipment for home use; 60dB is considered quite good. Values higher than this take you into the realm of professional equipment and this is one of the reasons for its high cost.

2-1-1	Dubbing losses
-------	---------------------------------

When dubbing (copying) a tape, you lose a certain amount of sound volume and sound quality. How much you lose depends a great deal on the quality of the tape decks and mixer, the quality of the tapes used, and the recording and play speeds used. For the following discussion, we will assume a loss of 3dB.

Fig. 2-1a shows a signal recorded with the high points at about 0dB ("0" on the VU meter) on a tape deck with a S/N of 55dB. Copying this recorded signal onto another tape using a tape deck of similar quality produces the result shown in fig. 2-1b. The noise already on the original tape combined with the new noise from the second tape deck produces a loss of 3dB; in other words, the noise level has risen 3dB to -52dB.

Fig. 2-1 Dubbing losses

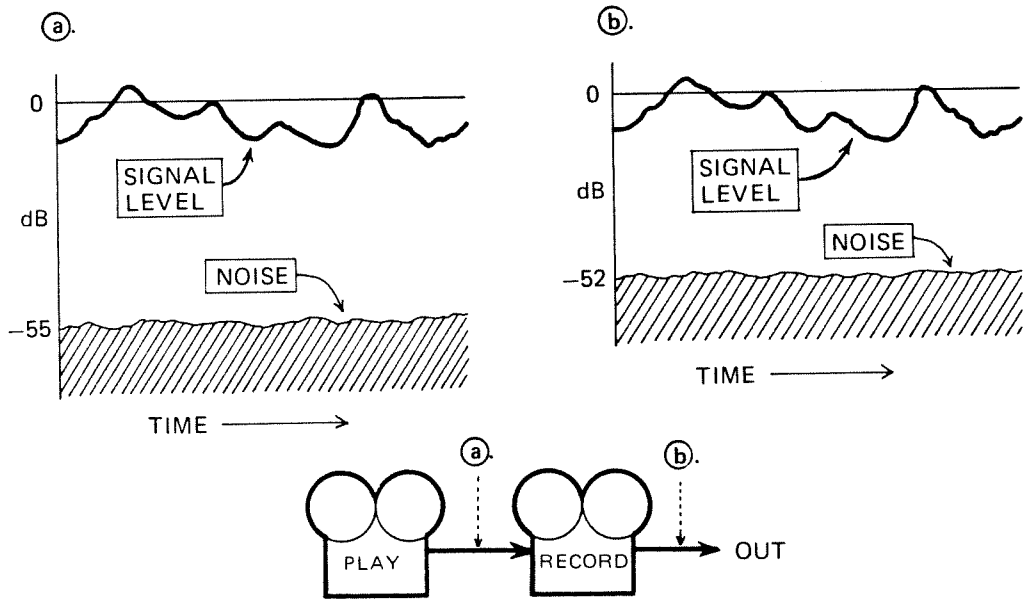
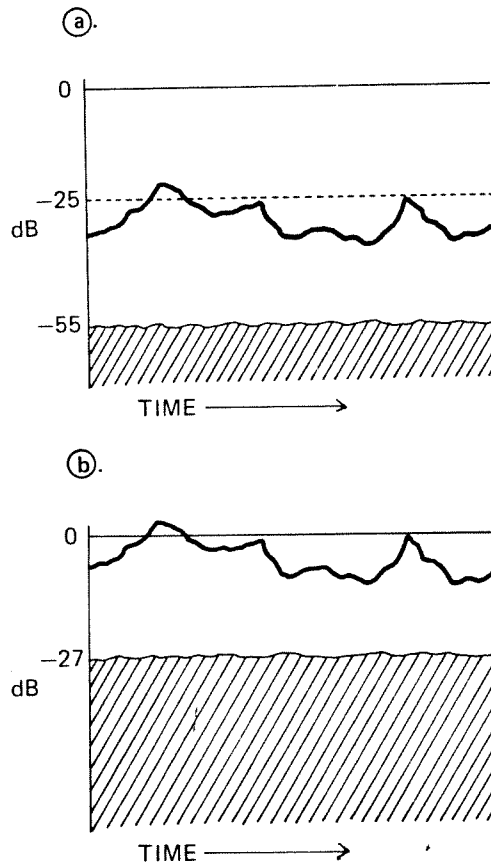

Fig. 2-2 Low level signal losses



2-1-2 Recording levels

Fig. 2-2a shows a signal which has been recorded at about -25dB for a *pp* effect. The difference between the noise level and the signal level is about 30dB . (In other words, the S/N for this recorded signal is about 30dB).

If you changed your mind and decided to copy the tape in fig. 2-2a so as to produce a signal of 0dB (*ff*), you would be amplifying the noise as well as the signal and the result would be to drag the noise level up to -27dB (fig. 2-2b). With the signal at 0dB (*ff*), this noise may not be able to be heard, but it definitely would be very noticeable during any rests in the passage and during the silence before the passage starts and after it ends.

This is why recording levels should be kept as near "0" VU as is possible until the very last moment (final tape).

2-2-0 Using the Mixer controls

2-2-1 The VOLUME controls

Also from the above, you should be able to see that the higher the level of the input signal to a piece of electronic equipment, the better the S/N ratio.

For this reason, when mixing, the VOLUME controls should always be kept as high as possible, while the MASTER VOLUME control is used to get the proper output level. In other words, even in a passage which should be *p*, set the VOLUME controls at or near maximum and use the MASTER VOLUME to cut the total level down to the *p* level; this produces a much better S/N in your output sound.

2-2-2 Using reverberation

The same is true of the EFFECT controls. As much as possible, keep the individual channel EFFECT controls at or near maximum and use the REVERB control to control the total reverberation dynamics.

When not using reverberation effect, keep the REVERB control at "0".

2-2-3

Using an echo chamber

Fig. 2-3 shows the connections for using an echo chamber.

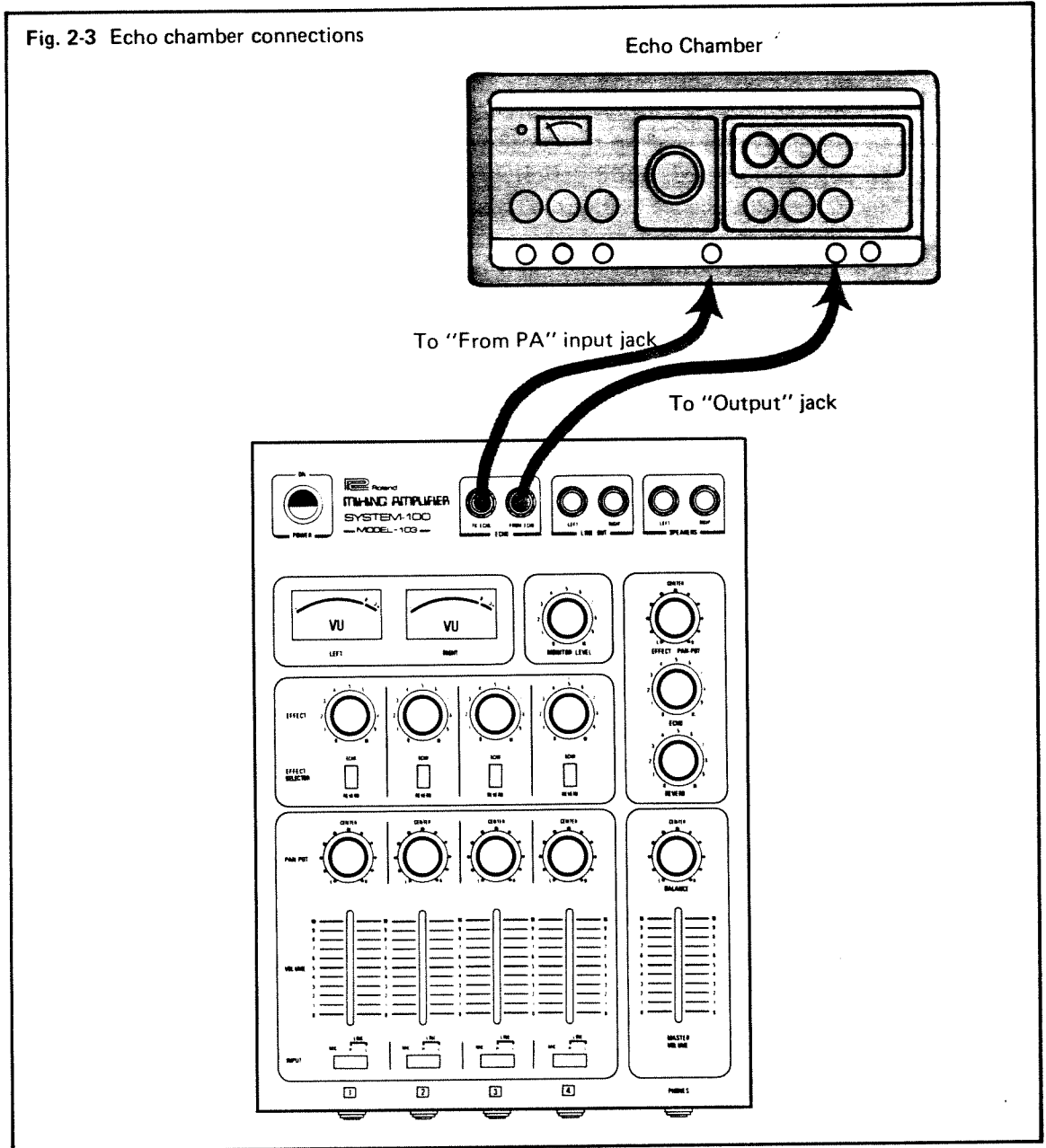

Again, keep the individual EFFECT controls at or near maximum. The ECHO control controls the level of sound sent to the echo chamber. (Check the echo chamber operating instructions for proper setting).

Keep the echo chamber output control at "0" if you are not using echo effect (or turn the echo chamber OFF or remove the plug in the 103 Mixer FROM ECHO jack).

2-3-1

Using the meters

The needle of a VU meter cannot possibly change at the same rate as an audio wave form, so their readings are much like the control voltage output of the S/H when using the OUTPUT LAG control. The peaks and sharp corners are rounded off and you get a more or less average indication of the true instantaneous value.

Fig. 2-4a shows a sound wave adjusted in amplitude so as to produce "0" or less on a VU meter. The dotted line shows the average VU meter reading and you can see that there are peaks which jump up over the "0" VU meter reading level. Most electronic amplifier circuits, therefore, have limits which are high enough to take care of these peaks without causing distortion, and with most common sounds this will be enough.

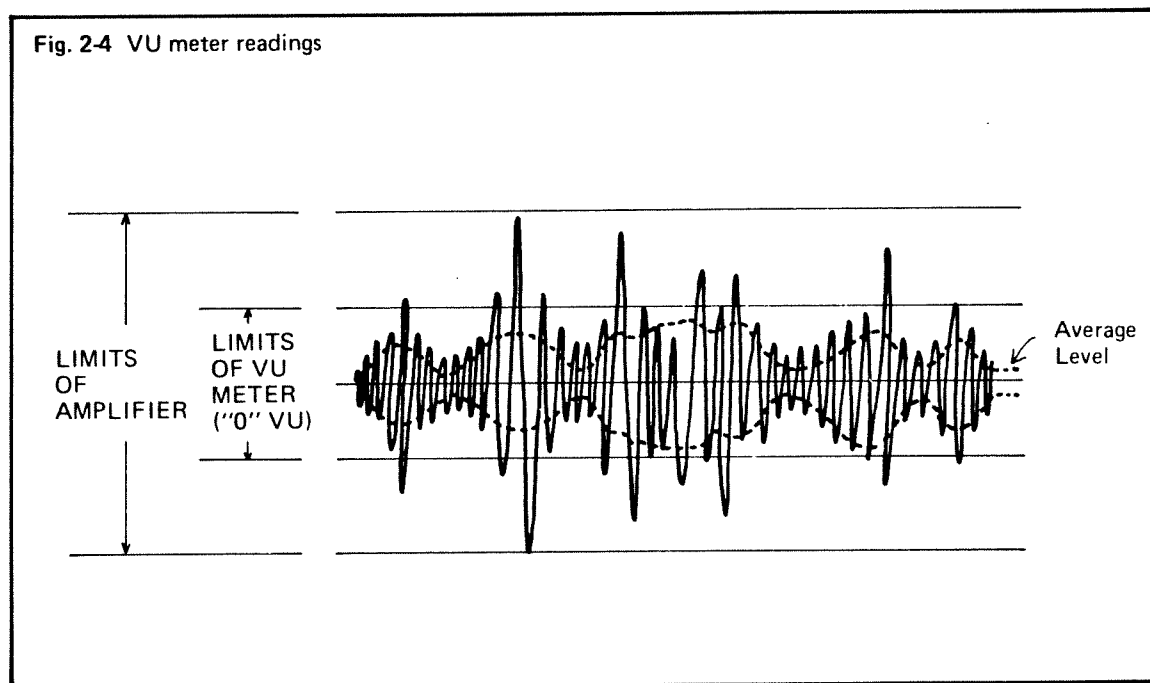

2-3-2

Problem wave forms

Fig. 2-5 shows some wave forms which will give trouble if you are not careful.

The wave form in fig. 2-5a contains many high sharp "spikes"; these spikes occur too quickly for the VU meter to catch them, so setting the average level at "0" causes these spikes to go beyond the limits of the circuits causing distortion.

Fig. 2-5b shows a very short sharp staccato sound. The attack and decay portions of the envelope are so quick that they hardly register on the VU meter at all.

Fig. 2-5c shows a sharp percussive sound which has similar effects.

Fig. 2-5 Troublesome wave forms

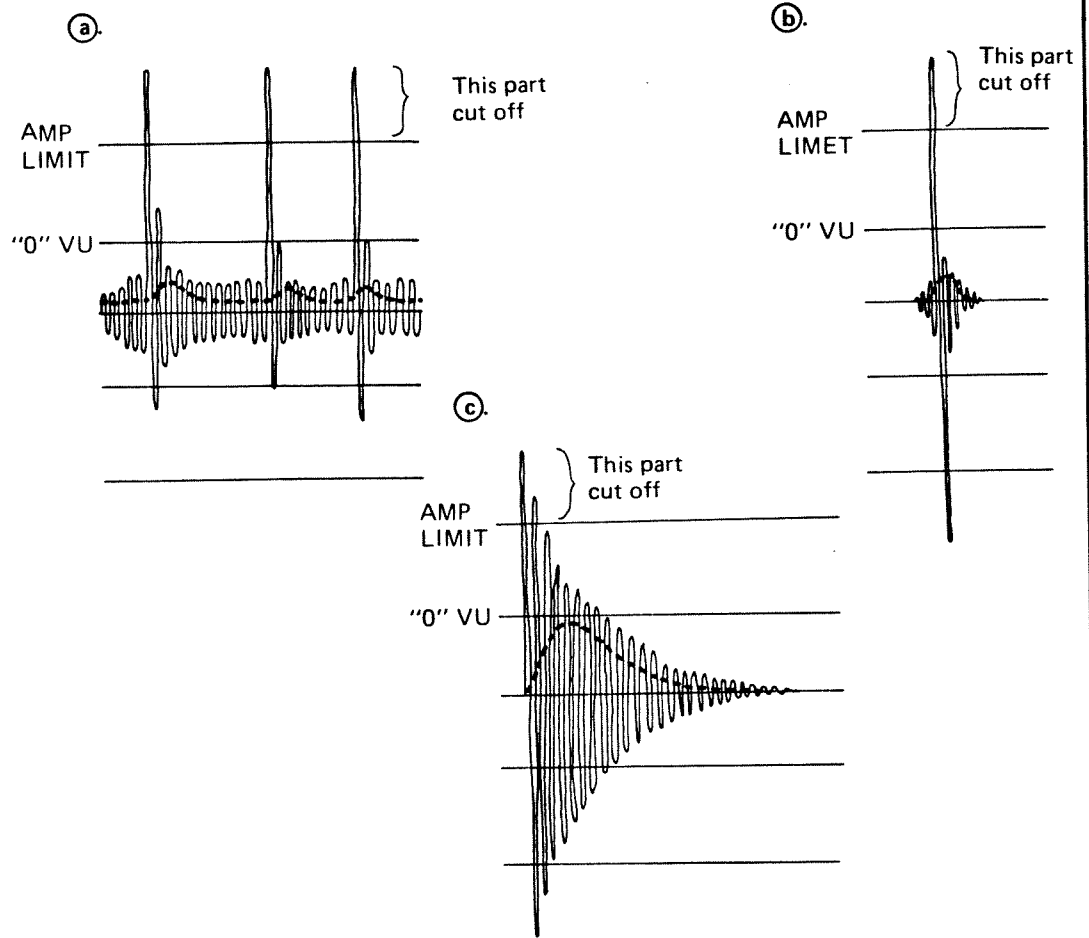

With sounds from the synthesizer the solution is rather simple: Just raise the ADSR SUSTAIN controls to "10" for setting the VU meters.

With other sound sources, you can often depend on your ear. Try setting the MASTER VOLUME control at "0" and slowly moving it up. Listen carefully to the sound and you may be able to detect the point where distortion begins; set the MASTER VOLUME at less than this point.

3.RECORDING WITH A FOUR CHANNEL TAPE DECK

The following is a brief outline of some of the techniques used in recording synthesizer music using a four channel tape deck in conjunction with the 103 Mixer and a second tape deck. Since they are so common, we will assume that the second deck is a two channel, four track deck, although any deck could be adapted.

Also, as the end of this section, are some notes on making synthesizer tapes without a second tape deck. (3-5-0).

3-1-0 Preliminaries

Fig. 3-1 Using one four channel tape deck and one stereo tape deck

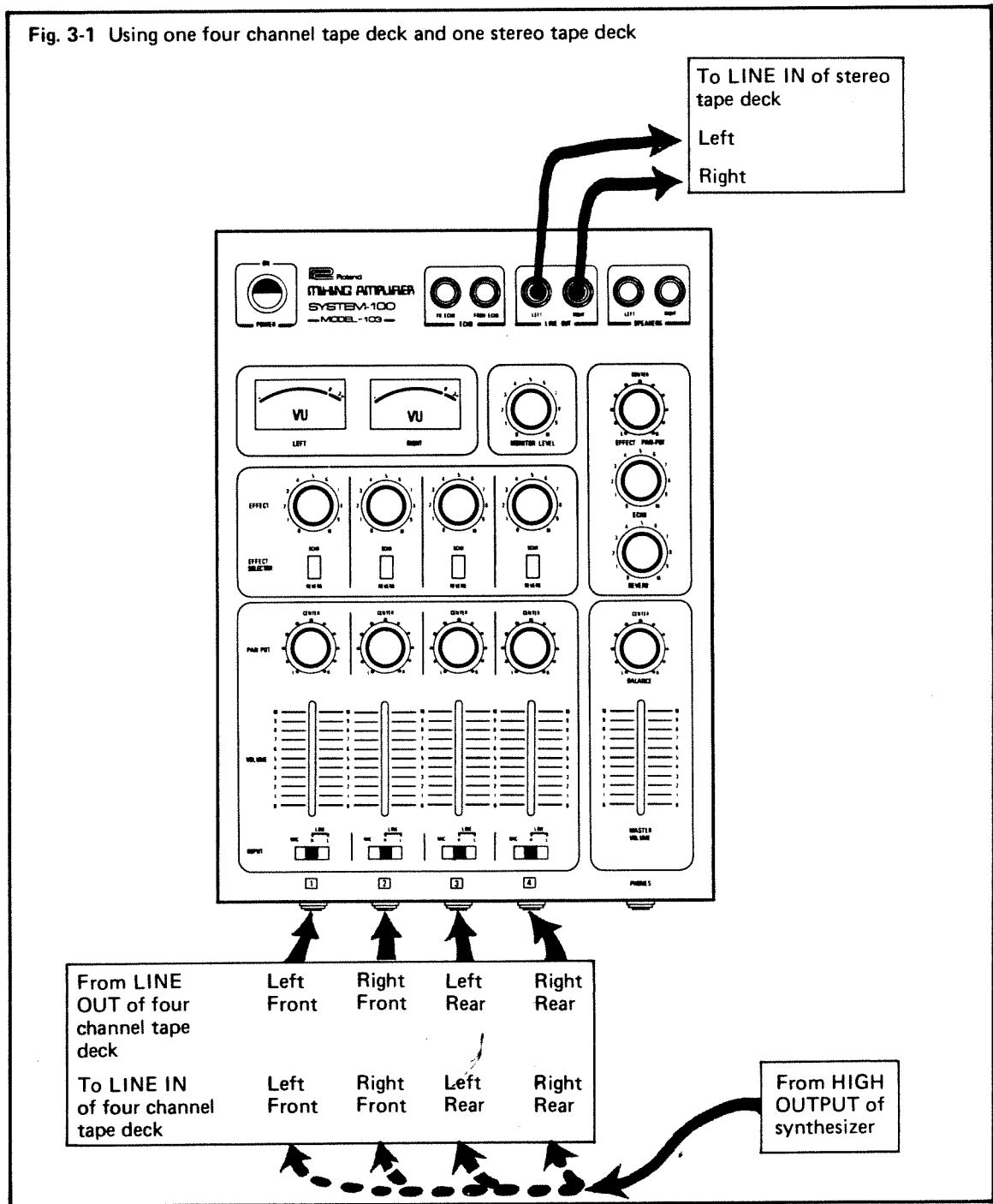
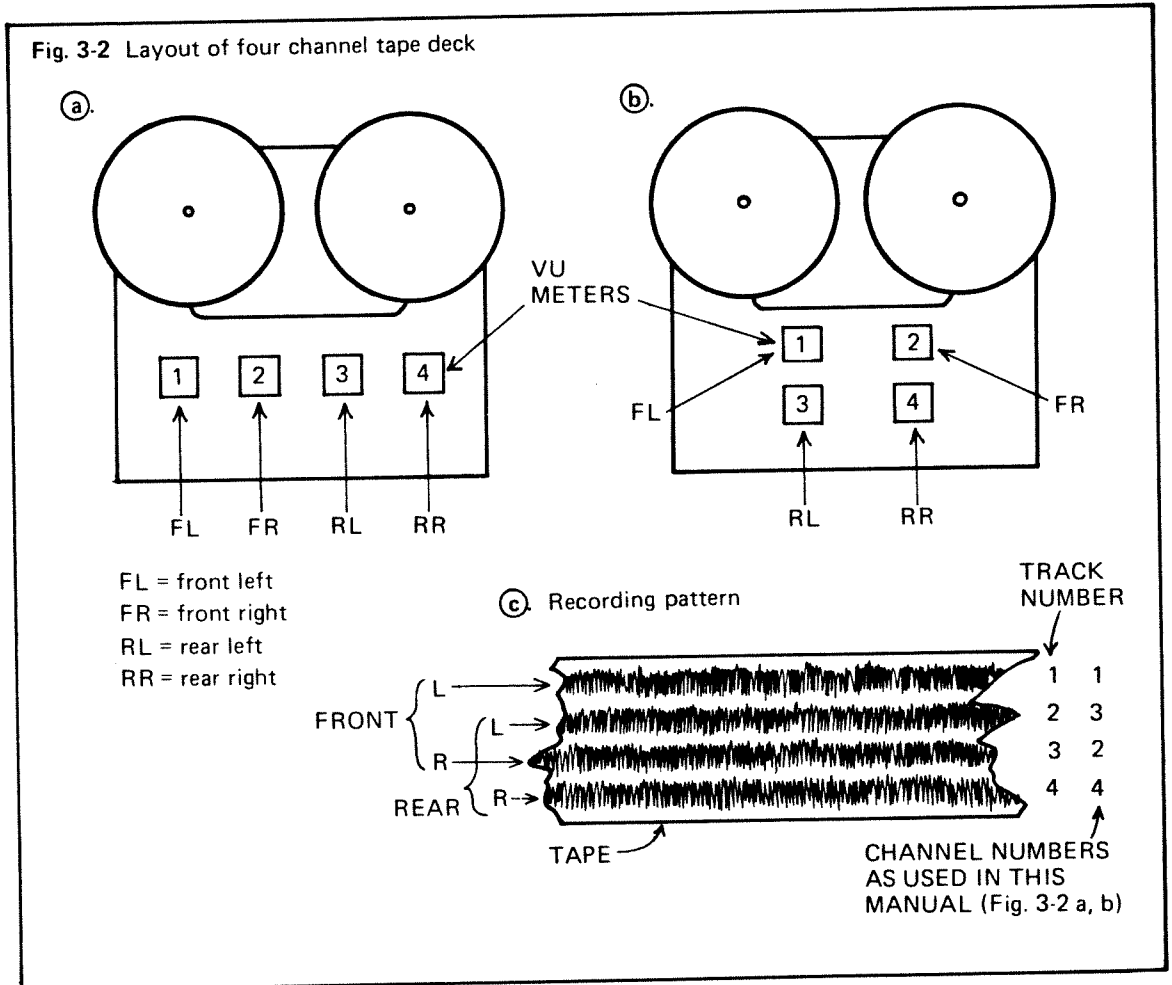

Fig. 3-1 shows the system connections. Monitoring can be done at the 103 Mixer PHONES jack (or with speakers) and the second tape deck left turned off until needed.

Most four channel tape decks are laid out more or less as shown in fig. 3-2 and for our purposes it is much easier to number the channels as shown. (The actual order is: 1, 3, 2, 4).



3-1-1

Synchro-track

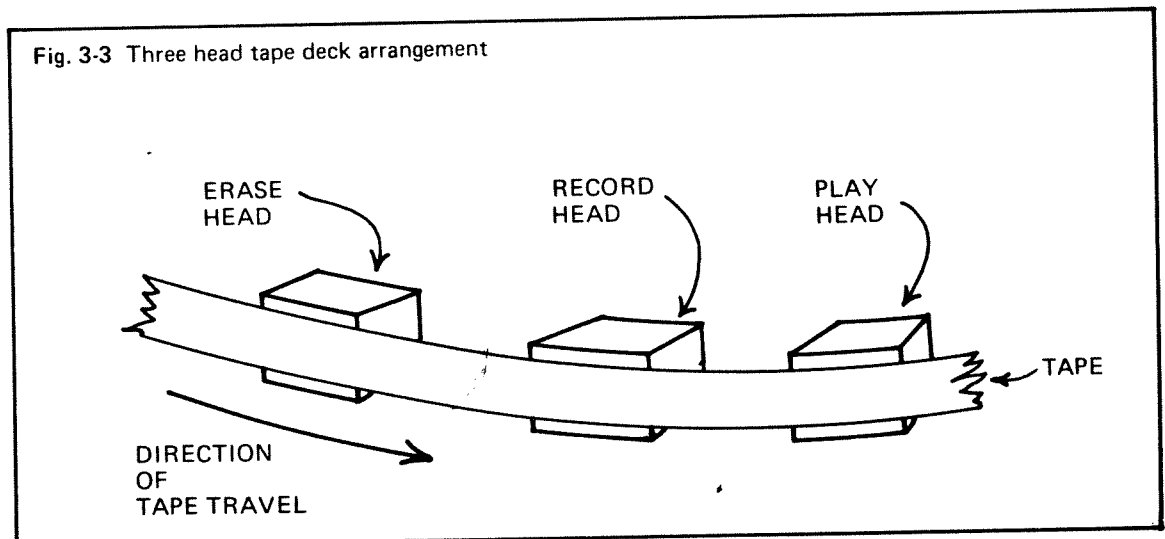

Fig. 3-3 shows the arrangement of heads in a three head tape deck. If you are listening to a voice on one track through the PLAY head and recording another voice through the RECORD head, you can see that because the tape takes time to travel between the heads, the two voices will not be together rhythmically when they are both palyed back through the PLAY head.

Synchro-track is a switch and related circuits which allow the RECORD head to be used as a PLAY head. Listening to recorded voices through the RECORD head will produce music without the delay.

3-1-2 Calibration of the tape deck output

If your four channel tape deck has separate PLAY level controls, you will need a test tape to calibrate them. If you don't have a test tape and don't care to buy one, you can make one very simply from a few feet of tape left over from some editing job by recording the synthesizer test signal at "0" VU meter reading on each of the four tracks.

Play the test tape and set the PLAY level controls for each channel so that the VU meters on the tape deck all read "0".

(Don't forget to record a test signal at the beginning of your synthesizer tape, too.)

3-2-0	Recording
-------	-----------

The idea is to record one voice on each of the four tracks; then, playing the tape back through the mixer, mix down and record with the second tape deck.

3-2-1 Voice order

As stated in the MODEL 101 SYNTHESIZER INSTRUCTION MANUAL (4-2-1, p. 66), the best voice for recording first will be the one with the fewest breaks in rhythm.

Since each voice is recorded separately on its own track, you can choose any voice, even the main melody line, to record first.

After that, you can choose an order which suits your own tastes; some voices may seem easier to record after others have been recorded.

3-2-2 Channel assignment

With music which has a very wide range of dynamic levels, even with only four VOLUME controls (plus the MASTER VOLUME), it can be quite confusing during the final mix down unless some forethought is given to channel assignments.

The most logical arrangement would seem to be to assign the main melody line to Channel 1, the bass line to Channel 4, and the inner voices to Channels 2 and 3. If you write your music out in score form, cues written in the parts can also greatly help.

3-2-3 Recording levels

Set the tape deck RECORD levels at their center points and set the synthesizer output so as to record at or near "0" on the tape deck VU meters.

3-2-4 Temporary "tic" track

It may prove useful to record a temporary "tic" on one track of the tape to help keep difficult parts together. This track can be recorded the whole length of the composition, if needed. When the other three tracks have been recorded, erase the "tic" track and put the fourth voice there.

One caution: Be careful of cross talk.

3-2-5 Cross talk

Cross talk refers to signal leakage from one channel to the next. Electronic circuits being imperfect, there will always be a certain amount of leakage of signal from one channel to the channels next door, but since the eventual outcome of making synthesizer tapes is the mixing together of all the channels anyway, even with a cross talk as high as -40dB, you can still maintain excellent stereo separation.

To prevent the possibility of the "tic" track signal from leaking over into a music track, record the "tics" at about -10dB. (Set the "tic" patch; raise the ADSR SUSTAIN level to "10"; set the VCA ADSR control so the record VU meter reads "-10"; return the SUSTAIN to "0"; record). This gives a poor S/N ratio but as long as you can clearly hear the "tics", this is unimportant.

(If you notice the "tics" leaking over into your music tracks, then use -20dB or lower for the "tics").

3-2-6 Dynamics

The dynamic expression can be recorded now or added later during the mix down process.

If you add dynamics now, the final mix down will be easier, but the final S/N will not be as good as it could be.

If you record the dynamics now, making changes later may prove impossible short of erasing the track and starting over. This may create problems if this track was used as a guide for recording the other tracks.

In passages such as this, however:

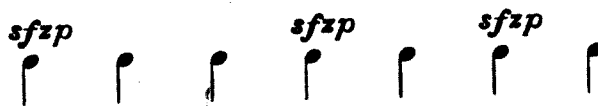

you may find it much easier to record the accents now.

The ideal may be a combination of recording some expression now and some later.

At any rate, all tracks should be recorded so that their loudest parts register "0" (or slightly more) on the VU meters in order to keep the S/N ratio as good as possible.

3-3-0

Mixing down

Once you have recorded all the voices and are satisfied with the results, you are ready to mix down.

3-3-1

Calibration

Thread the test tape on the four channel tape deck and check that the PLAY level controls still produce "0" on the four track deck VU meters.

Set the mixer as shown in fig. 3-4.

Fig. 3-4 Calibration of second tape deck

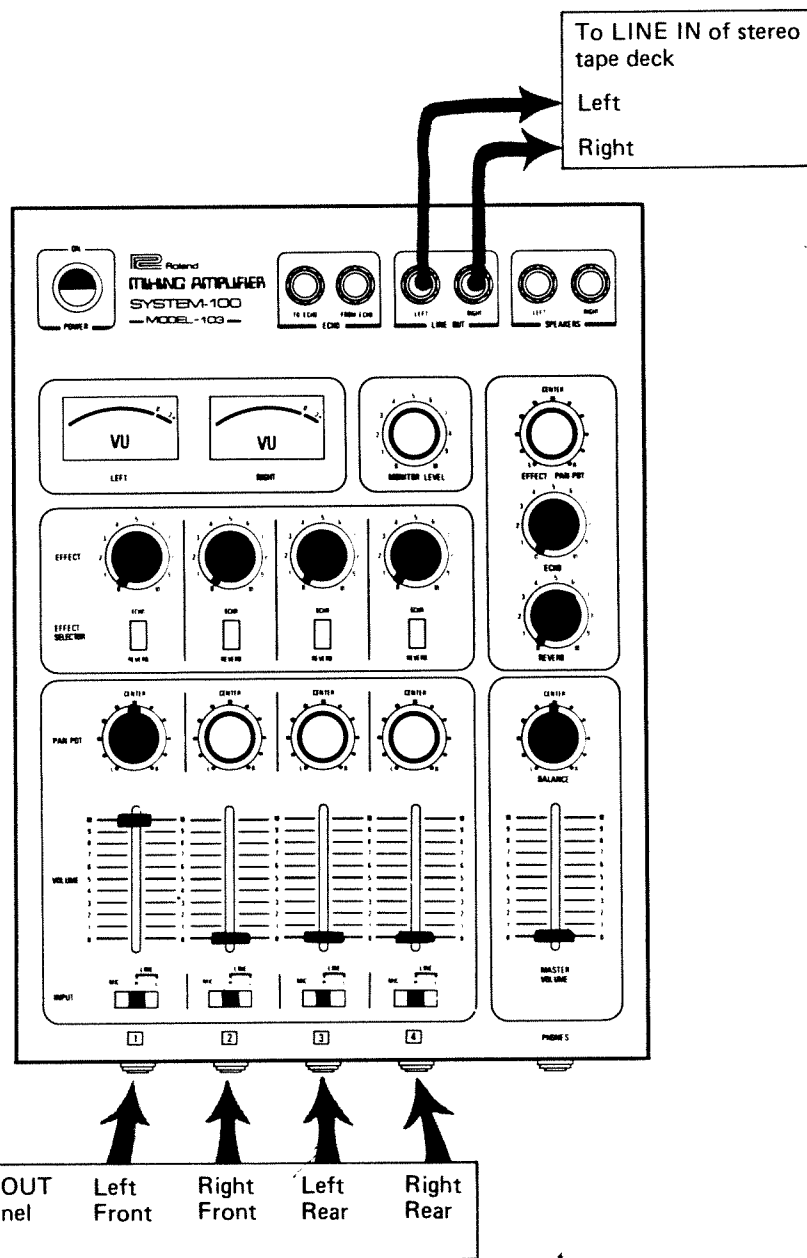

Move the MASTER VOLUME control up until both mixer VU meters read "0". (Use the BALANCE control if necessary).

Put the second deck in record mode and set the RECORD level controls so that the test tape played on the four channel tape deck produces "0" on the second deck VU meters.

3-3-2 Mixing

If the dynamic levels change a great deal, a number of practice runs will help.

Running both tape decks at half speed will help in compositions with many rapid changes. Also, cues written in your score, or just notes scribbled on paper will often help keep things straight.

3-4-0	Adding more voices.
-------	----------------------------

Once you have made the mix down run and are satisfied with the results, you are ready for editing. Or, you can try adding more voices.

3-4-1 Generations

The tape you made on the four channel tape deck is a first generation tape. The mixed down copy you made on the second deck is a second generation tape because it is a copy of the original (first generation) tape. A copy of the second generation tape would be a third generation tape because it is a copy of a copy.

3-4-2 Six voices

If you take your second tape and move it over to the four channel tape deck, you can add two more voices on the rear channels (Channels 3 and 4). For this, set the mixer controls as shown in fig. 3-5. The Channel 1 and 2 VOLUMES should be set at maximum unless you especially want the new voices to overpower the old.

3-4-3 Mixing

When mixing down, since Channels 1 and 2 should already have the proper dynamics, you probably won't have to touch the Channel 1 and 2 VOLUME controls.

3-4-4 Eight voices

Once you've made your mix down run, you can move the new tape (third generation, now) over to the four channel tape deck and add two more voices.

Fig. 3-5 Adding more voices

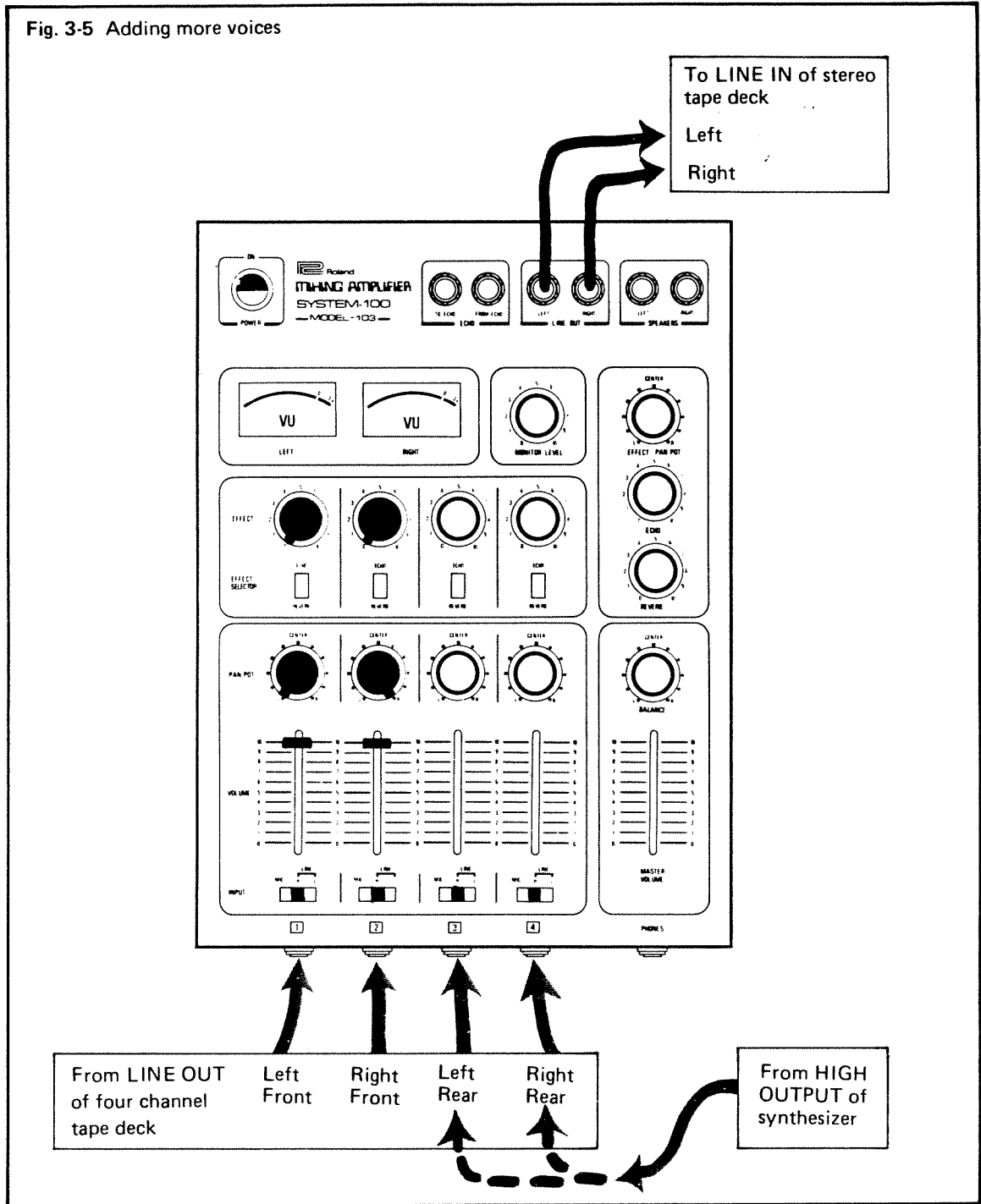

3-4-5

Quality loss

As mentioned in 2-1-1, with each generation, you lose a certain amount of sound volume and sound quality. For this reason, when recording more than four voices, it is a good idea to save the more important ones until last.

3-5-0

The four channel tape deck alone

Fig. 3-6 shows how you can record seven voices (mono) using a four channel tape deck and the 103 Mixer. The result at the end of Step 9 is a tape where voices 6 and 7 are first generation and voices 1, 2, 3, 4, and 5 are only second generation, thus resulting in very high quality sound.

Fig. 3-6 Recording without a second tape deck

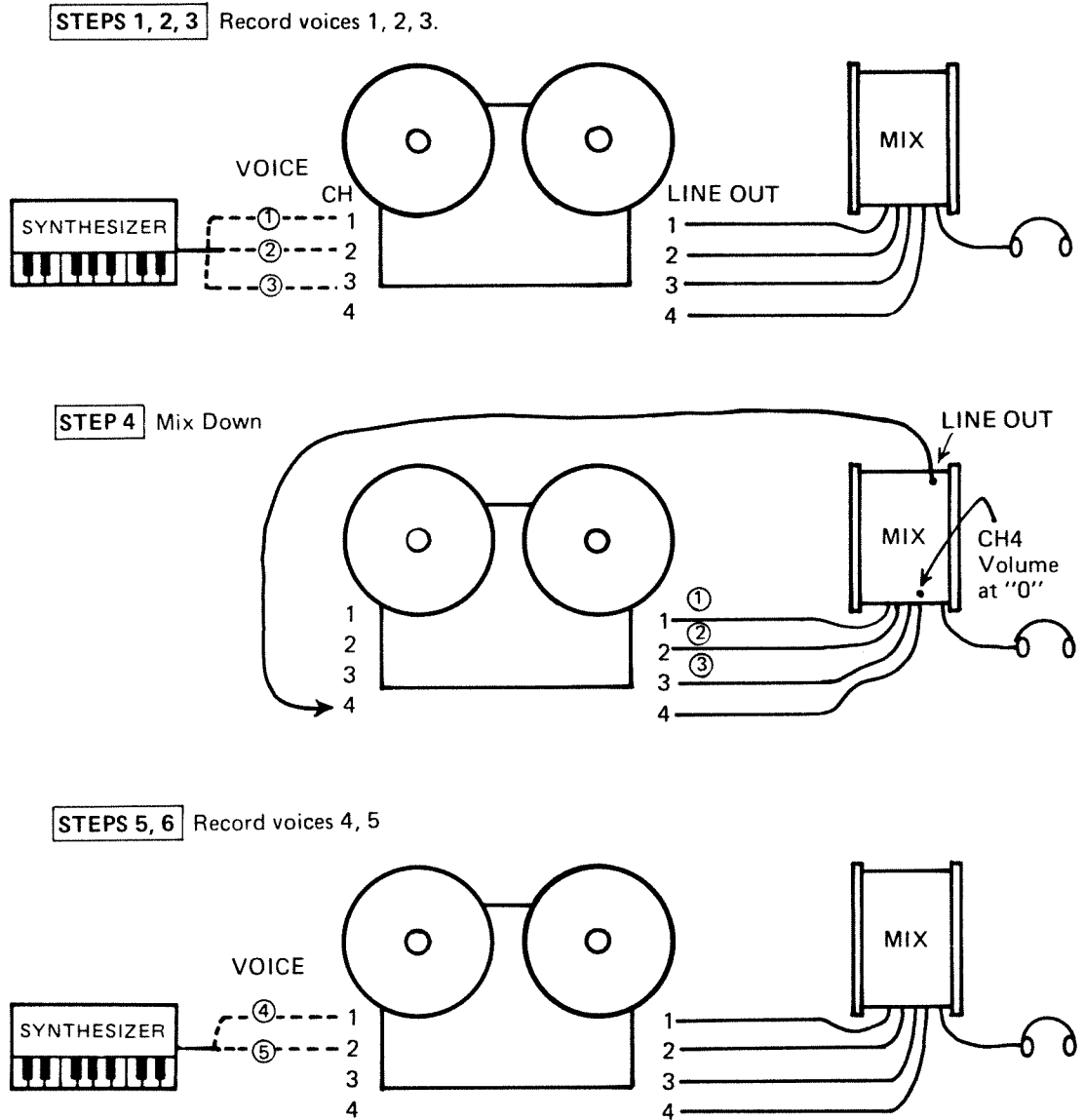

STEP 7 Mix down

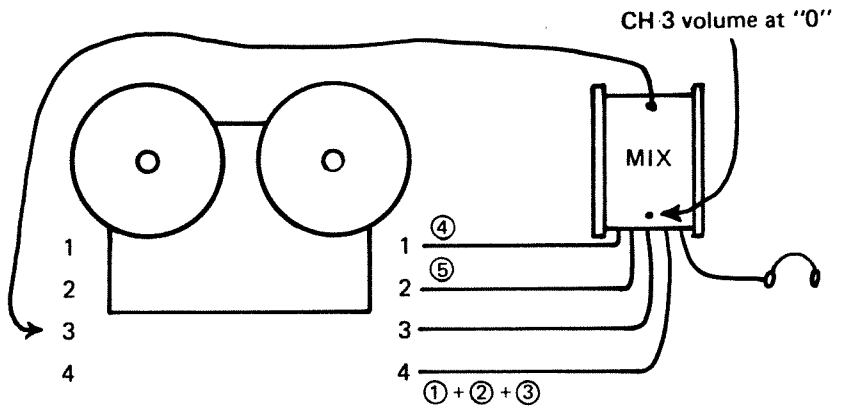

STEPS 8, 9 Record voices 6, 7

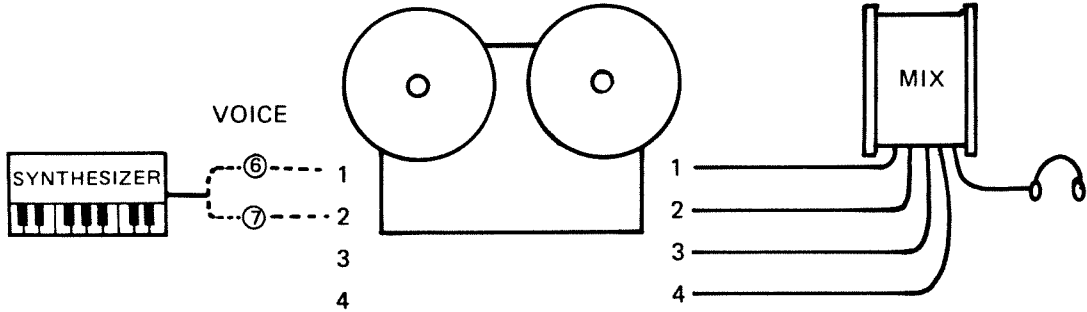

STEP 10 Final mix down

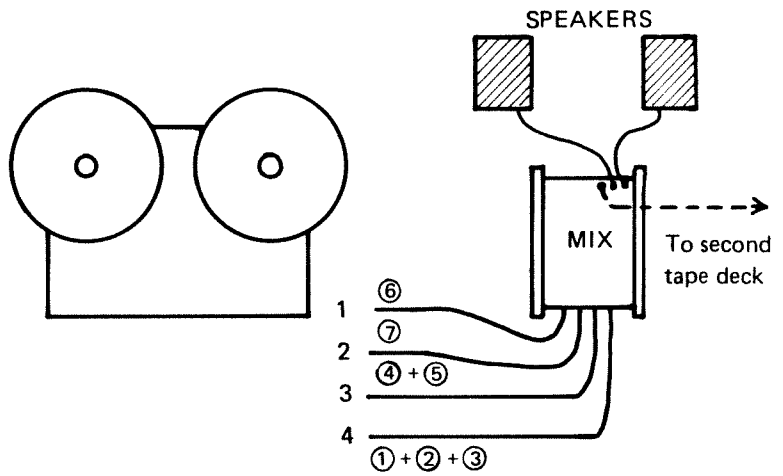

4. CAUTIONS

4-1-0 The reverberation unit

The reverberation unit is susceptible to shocks and vibration, but if you avoid jarring the mixer, under normal conditions this will cause little or no trouble.

If you live within a few feet of a railroad or super highway, you may pick up unwanted noise. Try placing the mixer on a foam rubber pad.

4-2-0 The PAN POTs

If you set all the PAN POTs at one extreme position and the BALANCE at the other extreme, you will get no sound output from the mixer.

4-3-0 False stereo

In natural surroundings, sound coming from your right will reach your right ear before it reaches your left ear. This is how we distinguish the direction of the source of a sound. For all practical purposes, the intensity of sound reaching both ears is the same.

In the synthesizer studio, we create the feeling of direction by making the sound coming out of one speaker stronger in intensity in relation to the sound from the other speaker. This is false stereo, but sitting in front of a pair of correctly spaced speakers, the result is almost the same as the natural situation: The stronger sound on the right will reach your right ear before the left ear.

False stereo creates a problem only when using extreme left or extreme right with headphones. If the sound from the right channel is maximum and the sound from the left channel zero (to place the sound at the extreme right), with headphones, your right ear will get all the sound and your left ear no sound; a very strange effect indeed.

If you want to avoid this effect, the best way is simply to monitor your recordings with headphones. This way, your ear will tell you how far you can turn the PAN POT to get the feeling of extreme right (or left) without the "dead ear" effect. (Using reverberation will also help).

THE LAST WORD....

A lot of time and effort has gone into the design and preparation of the SYSTEM 100 SYNTHESIZER, its accompanying instruction manuals and patch books. If you have any suggestions, ideas, questions, problems, complaints, praise, etc., please feel free to write to:

Synthesizer Project Manager
Roland Corporation
3-2-26, Shinkitajima
Suminoe-ku
Osaka, JAPAN

It may not be possible to reply to all letters, but all letters will be read and given due consideration by all staff members of the synthesizer division.

SPECIFICATIONS

MODEL 103 AUDIO MIXER

Input : 4 channel
Mic : 1.5mV/2.2K Ω
LINE-H : 75nV/15K Ω
LINE-L : 0.775V/more than 100K Ω

Output :
Line out : 2 channel stereo out
0.775V/1K Ω
Speaker out : 8 Ω x 2
3W x 2 (Max)
Headphone : 8 Ω stereo headphone

Echo : To ECHO : 140mV
From ECHO : 20mV

Frequency range : 20Hz-25,000Hz (-3dB)

S/N : more than 60dB (REVERB off) (Input: LINE-L, H)

Cross talk : more than 58dB

Controls :
INPUT SELECTOR : MIC, LINE-L, LINE-H x 4
INPUT VOLUME : x 4
PAN POT : x 4
EFFECT SELECTOR : Echo or reverb x 4
EFFECT VOLUME : x 4
MASTER VOLUME : x 1
BALANCE : x 1
ECHO VOLUME : x 1
REVERB VOLUME : x 1
EFFECT PAN POT : x 1
MONITOR VOLUME : x 1

Dimensions and weight:

Overall size : 280mm (11") wide, 355mm (14") deep,
145mm (5-3/4") high
Net weight : 6.5Kg (14.3 lbs.)

Power requirements : 100-120V 50-60Hz 25W max
220-250V 50-60Hz

Specifications are subject to change without notice.

Copyright © 1976 by ROLAND CORPORATION

All rights reserved. No part of this publication may be reproduced in any form without prior written permission of ROLAND CORPORATION.

INDEX TO TERMS

The first figure after each word indicates the page number.

The second figure indicates the paragraph number.

The words are underlined in the text to make them easier to find.

bel, 13; 2-1-0

cross talk, 22; 3-2-5

dB, 13; 2-1-0

decibel, 13; 2-1-0

dubbing, 13; 2-1-1

first generation, 24; 3-4-1

generation, 24; 3-4-1

second generation, 24; 3-4-1

signal, 13; 2-1-0

signal-to-noise ratio, 13; 2-1-0

S/N, 13; 2-1-0

synchro-track, 21; 3-1-1

third generation, 24; 3-4-1

 Roland®

10266

UPC

10266

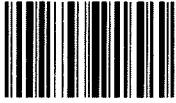

18981