

Roland

DIRECTOR-S

SEQUENCER PACKAGE

SYS-503

Owner's Manual

for S-50

オーナーズ・キーについて

[Format A]、[Format B]、[Backup]、[Song save]、[Bank save]、[System save]の操作を行なうためには、付属のオーナーズ・キーが必要です。

*オーナーズ・キーを紛失してしまいますと、これらの操作が行えなくなりますので、大切に保管してください。

オーナーズ・キーは、リア・パネルの補助コントロール用コネクタに差し込みます。

Owner's Key

Your owner's key is necessary for the functions **Format A, Format B, Back up, Song save, Bank save, and System save.**

*Take care of it. If you lose, these important functions will not be available.

The owner's key plugs into the EXT CONTROLLER jack at the rear of the S-50.

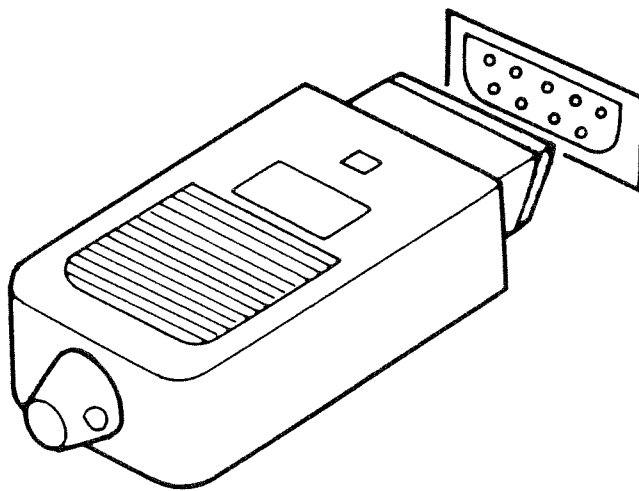

The DIRECTOR-S software package is an exciting new piece of software that changes your Roland S-50 Digital Sampling Keyboard into a 16-channel MIDI sequencer. All you have to do is insert the new system disk in the floppy disk drive of your S-50.

FEATURES

- A 16-channel MIDI sequencer with up to 16 voices and 32 tones.
- Easy-to-use software that provides continued access to all existing high quality sound libraries for the S-50 yet adds an entirely new range of musical possibilities to your keyboard.
- A choice of two disk formats: (A) Sound data plus one song and (B) "Song only" disks with 36 songs and no sound data.
- A new "chain play" function that allows you to automatically play back up to six songs in succession from the S-50 memory.
- Complete facilities for editing notes and all other types of MIDI events.
- Instant access to the latest in electronic sequencer functions – PUNCH IN, PUNCH OUT, quantizing, and gate timing adjustment, for example.
- Synchronized playback with other sequencers, drum machines, and other MIDI equipment.
- Rapid access to the Sampler System Ver. 2.00 tone editing facilities.
- A detailed display that presents all relevant data in an easy-to-read form so that editing is easier and faster.

Note: This software requires a CRT display. Refer to p.9 (color) of your S-50 Version 2.00 Owner's Manual for complete details as to the type of monitor and connections required.

Note: This software comes with a set of label decals listing the functions which the software assigns to the seven MODE keys. Apply them in the positions shown in Figure 1.

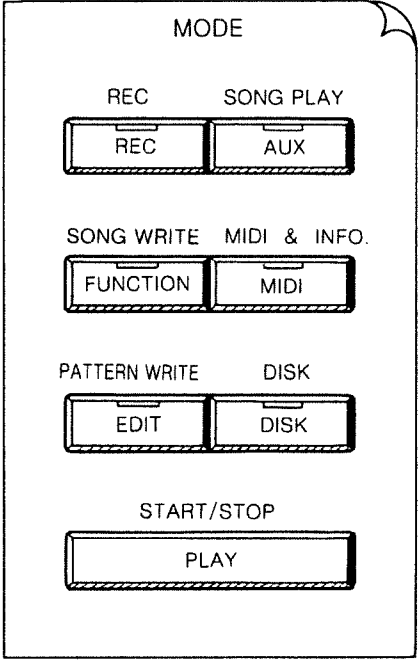

Figure 1 Labels for the DIRECTOR-S MODE Keys

Caring for Your Floppy Disks

Warning: Although your 3.5-inch floppy disks have hard protective cases, the actual recording medium is a thin coating of magnetic material on a flimsy plastic disk, and the recording density is very high. To prevent irretrievable loss of your valuable data, always handle your disks with the proper care.

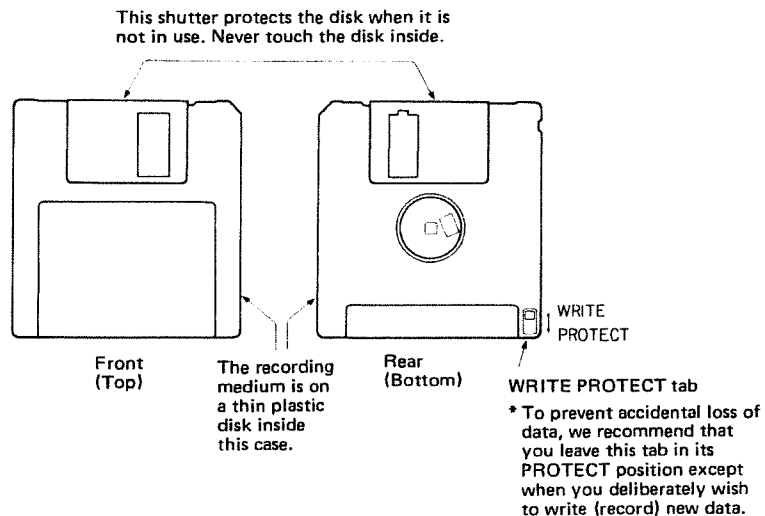

Figure 2 Floppy Disk

- Never open the shutter and touch the magnetic film inside. The oil from a fingerprint is sufficient to interfere with proper recording and playback.
- Avoid dusty and smoky environments. Any airborne particulate matter that lands on the surface of the disk risks scratches that can lead to irretrievable loss of data.
- Keep the disk away from strong magnetic fields — TV sets, speakers, and even CRTs, for example.
- Do not store at temperatures outside the 5–50°C (41–122°F) range. Do not, for example, leave in direct sunlight or in a locked car on a clear, hot day.
- To prevent accidental loss of data, always keep the WRITE PROTECT tab in its PROTECT position. Shift it to the WRITE position only when you wish to write (record) new data or overwrite old data and then be sure to return it to the PROTECT position immediately afterwards.
- Do not switch off the S-50 or attempt to remove the disk while the disk access LED is lit. Wait until the disk stops.
- Avoid shocks to the S-50 — and the disk drive in particular — while the disk is in motion. Such a shock may disturb head alignment and interfere with playback.

Note: Refer to your S-50 Version 2.00 Owner's Manual for complete details on caring for your instrument.

TABLE OF CONTENTS

1 Preparing to Play	8	5 SONG WRITE	49
1 Connections	8	1 SET	49
1.1 Mixer, keyboard amplifier, etc.	8	2 DELETE	50
1.2 Monitor	9	3 INSERT	50
2 Booting	9	4 SET CLEAR	52
2.1 The DIRECTOR-S system disk	9	5 SONG NAME	52
2.2 Procedure	10	6 DISK COMMANDS	53
3 Backing Up the System Disk	11	1 Two Types of Disk	54
2 Introduction	13	2 Format A	55
1 Sound Sources and the Sequencer	13	3 Format B	56
1.1 Creating song data	13	4 BACKUP	57
1.2 Sound sources	14	5 DISK CHECK	58
2 Loading and Saving Data	15	6 SONG SAVE	59
3 The Five DIRECTOR-S Modes	16	7 SONG LOAD	61
4 Standard Operations	17	8 SOUND SAVE	62
3 SONG PLAY	18	9 SOUND LOAD	63
4 PATTERN WRITE	20	10 SONG & SOUND	64
1 PATTERN PLAY	21	11 BANK SAVE	65
2 Changing the Screen	22	12 BANK LOAD	66
3 MICROSCOPE Screen	23	13 SYSTEM SAVE	67
3.1 Screen layout	23	14 CHANGE SYS	68
3.2 CPT units	24	7 OTHER FUNCTIONS	70
3.3 The ALL display	24	1 SONG CHANGE	70
3.4 The SEL display	25	2 CHAIN PLAY	70
3.5 Modifying data	26	3 MIDI SYNC CLOCK	72
3.6 Deleting data	27	3.1 INT — The S-50 as master	72
3.7 Inserting data	28	3.2 EXT — The S-50 as slave	72
4 TONE SELECT Screen	30	8 RECORDING MC-500 DATA	73
4.1 Selecting a tone	30	1 Setting Up the MC-500	73
4.2 Playing the tone	31	2 Setting Up the DIRECTOR-S	73
4.3 Erasing the tone data	31	3 Recording the First Pattern	74
4.4 The tone MICROSCOPE screen	31	4 Preparing for the Next Pattern	74
5 CHANNEL SELECT Screen	32	5 Storing the Song	74
5.1 Selecting a channel	32	SPECIFICATIONS	75
5.2 Playing the channel data	33	ERROR MESSAGES	76
5.3 Erasing the channel data	33		
5.4 The channel MICROSCOPE screen	33		
6 Checking Patch Numbers and Note Data	34		
7 Preparing to Record	35		
7.1 Clearing data	36		
7.2 Specifying the sound source	37		
7.3 MIDI and Recording SWITCH menu	38		
7.4 Metronome display	39		
7.5 Specifying the time scale	40		
7.6 PATTERN WRITE Parameters	41		
8 Recording a Pattern	44		
9 Editing Data	46		
9.1 PATTERN COPY	47		
9.2 DELETE	47		
9.3 TRANSPOSE	47		
9.4 CHANGE M.CH	47		
9.5 CHANGE VEL.	48		

1 PREPARING TO PLAY

1. Connections

Note: Always make sure that the power to all units is off before connecting or disconnecting an individual unit.

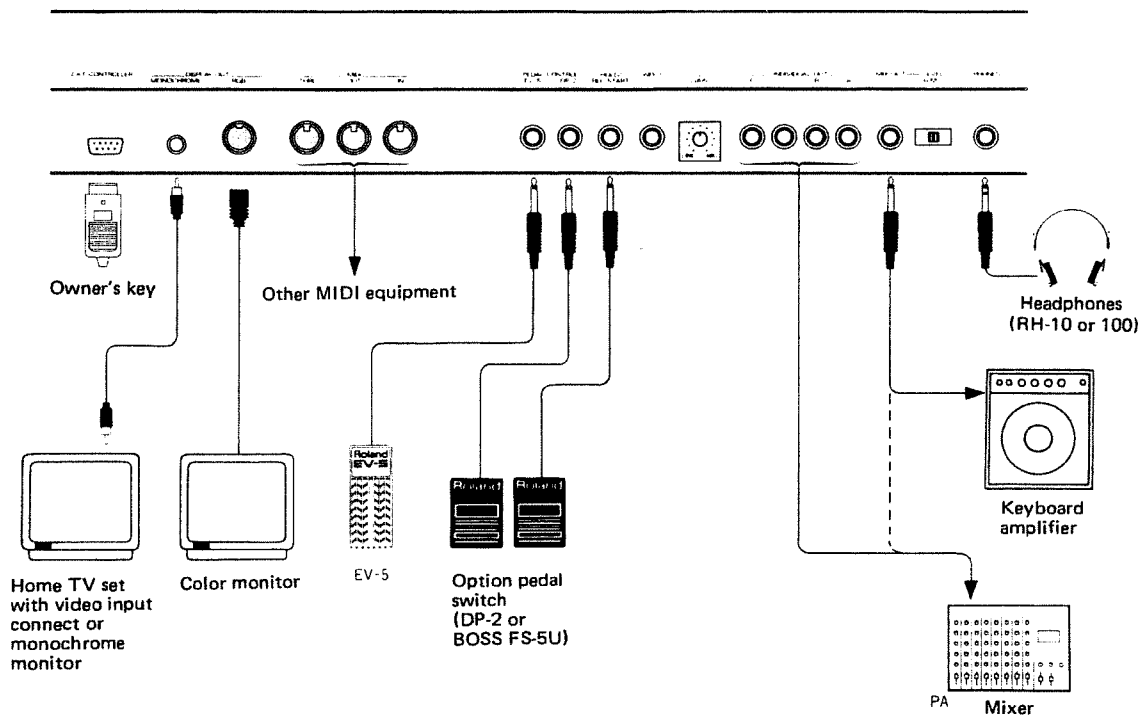

Figure 3 External Connections

1.1 Mixer, keyboard amplifier, etc.

There are no speakers or amplifiers built into the S-50. To hear the output, connect a pair of monaural headphones to the PHONES jack at the rear or feed the signal from the MIX OUT jack to a speaker system through a mixer, keyboard amplifier, or other power amplifier.

Note: Refer to p. 10 of your S-50 Version 2.00 Owner's Manual for instructions on the use of the INDIVIDUAL OUT jacks.

1.2 Monitor

This software requires a CRT display. If you have a color monitor, refer to the p.9 of your S-50 Version 2.00 Owner's Manual. Otherwise, connect a 200-line monochrome monitor or home TV set with a video input jack to the MONOCHROME jack.

2. Booting

2.1 The DIRECTOR-S system disk

The S-50 cannot operate without software. When you turn on the power, it looks for this software on the disk in the drive, copies it into memory, and then begins running it — a process called **booting**. Substituting the DIRECTOR-S disk for the Ver. 2.00 disk is therefore all that is required to change your S-50 keyboard into a sequencer.

The two disks supplied contain identical copies of the **DIRECTOR-S software**. They also contain ready-to-play **song data** and **sound data** determining the initial tones.

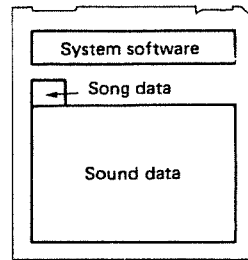

Figure 4 DIRECTOR-S Disk (Format A)

One of the first things that the system software does is to read this data into memory so that the sequencer is ready to play.

PREPARING TO PLAY

2.2 Procedure

- (1) Check all connections to other equipment.
- (2) Make sure that there is no disk in the drive.
- (3) Turn on the power in the following order: Display → S-50 → Amplifier
- (4) Wait for the message "Please Insert System Disk" to appear on the screen and the LED on the drive to light.
- (5) Make sure that the WRITE PROTECT tab on the bottom of the disk, the side with the circular metal piece, is in the PROTECT position, away from the edge.
- (6) Insert the disk, label side up and press until it makes an audible click.

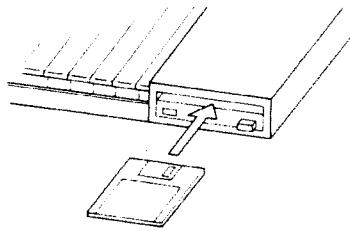

Figure 5 Inserting a Disk

- (7) Wait while the S-50 loads the software, sound data, and song data.
- (8) Wait for the SONG PLAY screen to appear.

Note: Do not switch off the S-50 or attempt to remove the disk while the disk access LED is lit. Such actions can irretrievably damage the data on the disk.

3. Backing up the System Disk

Any floppy disk will eventually wear out. Since the DIRECTOR-S software is so important to the operation of your sequencer, you should protect your investment by using only copies, called **backups**, and storing the original in a safe place. The same applies to all disks with important data.

The BACKUP function copies the software and data from the S-50 memory to a floppy disk.

Note: To back up a system disk (as opposed to a data disk), you must first connect the owner's key.

Procedure

The DIRECTOR-S menu system provides a BACKUP function which copies from the S-50 memory to a floppy disk.

Note: Use only double-sided, double-density, double-track (135 tpi) 3.5-inch floppy disks – for example, Roland MF2-DD micro floppy disks.

Note: If you have edited data since copying from the original disk, the backup disk will contain the **edited** versions, not the originals.

- (1) Press the button on the drive to eject the DIRECTOR-S system disk.
- (2) Shift the WRITE PROTECT tab on the backup disk to its WRITE position next to the edge).
- (3) Insert the backup disk.
- (4) Connect the owner's key to the EXT CONTROLLER jack at the rear of the S-50.

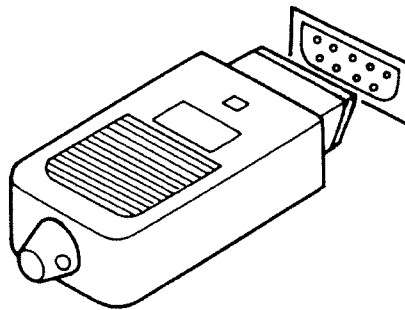

Figure 6 Connecting the Owner's Key

PREPARING TO PLAY

- (5) Press the **DISK** key to display the first page of the disk functions menu.
- (6) Press the **+PAGE** key to display the second page.
- (7) Press the **P8** key to select the **BACKUP** function.
- (8) Press the **ENTER** key to start execution.
- (9) Wait for the message **"COMPLETE"**.
- (10) Press the button on the drive to eject the disk.
- (11) Return the **WRITE PROTECT** tab on the backup disk to its **ON** position (away from the edge).
- (12) Press the **AUX** key to return to the **SONG PLAY** display.

Note: Your Roland dealer will, for a small fee, replace your system disk should it become irreparably damaged.

2 INTRODUCTION

1. Sound Sources and the Sequencer

DIRECTOR-S is new system software that changes your S-50 keyboard into a multi-channel MIDI sequencer capable of controlling other electronic musical instruments connected using 16 MIDI-channels. Of course, the software also provides regular access to the sound sources built into the keyboard.

1.1 Creating song data

The S-50 has room for six **songs**, command sequences for controlling MIDI instruments. Each song is made up of **patterns**, shorter command sequences each consisting of up to 16 bars and up to 200 notes. A song may use the same pattern any number of times.

You create these patterns with real-time recording of MIDI events on separate channels. These events can come from the S-50 keyboard or any other MIDI instrument.

Note: For one MIDI instrument to control another, the second must be receiving on the same channel on which the first is transmitting. Since a DIRECTOR-S song can contain data for up to 16 such channels, the sequencer is capable of simultaneously controlling 16 MIDI sound sources.

The process consists of overdubbing data for individual channels: You set the keyboard to transmit on the channel on which a particular instrument will be receiving, record the pattern for that instrument, and then repeat the process for the other instruments. The result is a pattern that simultaneously controls individual instruments on separate channels.

INTRODUCTION

1.2 Sound sources

A song can also use the S-50's 16 built-in **voices**. The specifications for these voices form another type of data, called **sound data**. In fact, the S-50 cannot produce any musical output until the software has read this data from the system disk. Once this data is in memory, you can switch to the sampler software to add or edit sound specifications. Refer to your S-50 Version 2.00 Owner's Manual for the relevant procedures.

The S-50 allows you to divide these 16 voices into up to four **voice groups**, each of which receives on a separate MIDI channel. Each voice group has a separate **patch** which assigns individual tones to each note on the keyboard. This approach makes it possible to vary the output with the key or note number for each tone group.

Note: The **keymode** setting can halve the effective number of voices available. (Refer to p. 39 of your S-50 version 2.00 Owner's Manual.)

The S-50 has memory space for up to 32 such tones, which are stored and edited with the sampler software. It is not necessary to switch to the sampler software, however, to change these tone assignments. The software's **MULTI-PATCH PLAY** function provides the same capability.

The four **INDIVIDUAL OUT** jacks at the rear of the S-50 provide access to these four voice groups. The **VOICE MODE** setting controls these jack outputs. (Refer to pp. 89–91 in your S-50 Version 2.00 Owner's Manual.)

Since controlling the S-50's internal sound sources requires at most 4 MIDI channels, there are always at least 12 channels available for controlling other instruments.

Setting the keyboard's sending channel to a voice group's receiving channel allows you to access that group's patch from the keyboard.

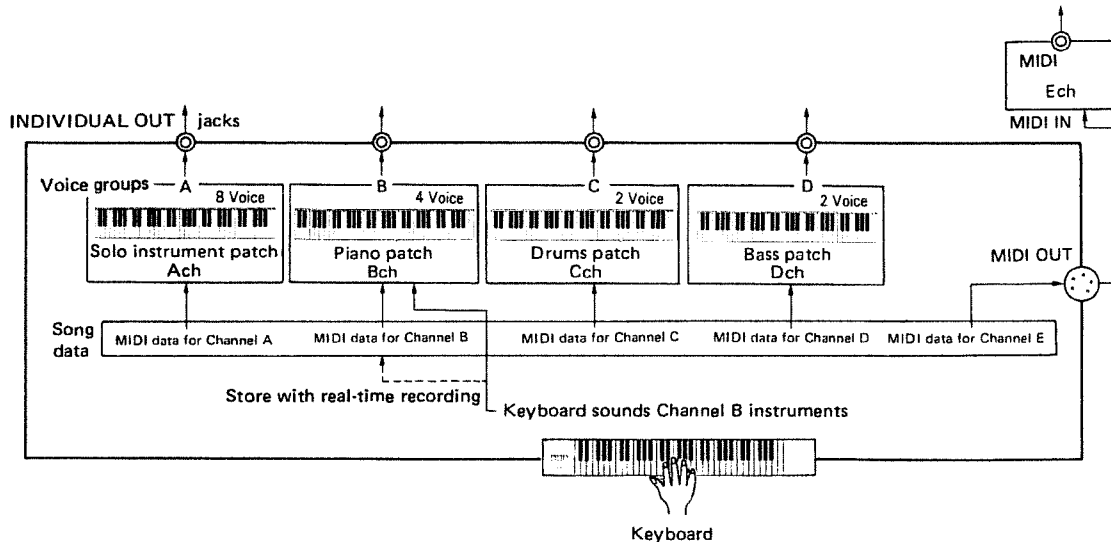

Figure 7 Block Diagram

2. Loading and Saving Data

All data in the S-50's memory disappears when you turn off the power. If you wish to use new or edited song data at some later date, you must **save** it – that is, copy it to a permanent storage device, a floppy disk. Then, when you wish to use this data, you must **load** it – that is copy it from the disk back into the S-50 memory.

Note: The software automatically loads the data on the system disk when you **boot** the system. You may, however, wish to replace it with data from an S-15 version 2.00 disk or a DIRECTOR-S data disk.

3 The Five DIRECTOR-S Modes

The DIRECTOR-S software features five basic modes, whose names are listed on the decals next to the MODE keys.

- ★ **SONG PLAY (AUX key)**
The starting point, this allows you to play any of the songs available either individually or, with the CHAIN PLAY function, in sequence.
- ★ **PATTERN WRITE (EDIT key)**
This is for editing pattern data for the current song.
- ★ **SONG WRITE (FUNC key)**
This is for combining patterns into songs and labeling the result.
- ★ **MIDI & INFO (MIDI key)**
This is for setting MIDI parameters, setting of recording switches, controlling the metronome, and checking tone and patch names.
The setting of these parameters are stored with the song data.
- ★ **DISK COMMANDS (DISK key)**
The commands available include SAVE and LOAD.

4. Standard Operations

Certain operations are common to all screens:

- **Changing modes**

To change modes, simply press the corresponding MODE key to change the label in the upper left hand corner of the display and light an indicator lamp in the key.

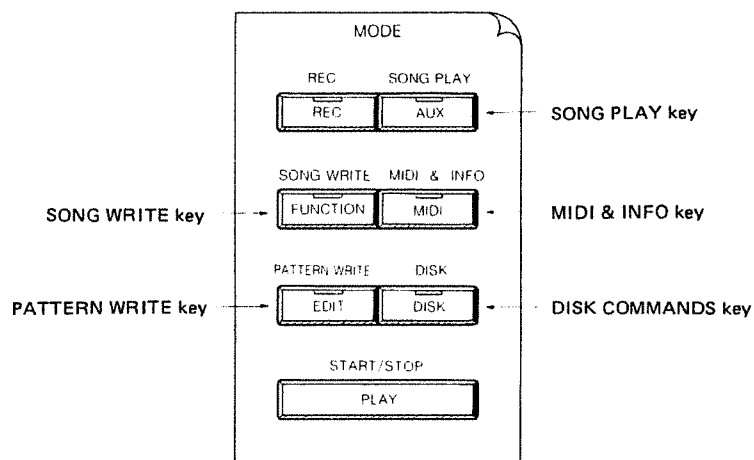

Figure 8 DIRECTOR-S MODE Keys

- **Cursor control**

The arrow keys in the CURSOR section move the cursor, a highlighted band, about the display in the indicated direction. This band selects a value for editing. Holding down an arrow key produces repeated motion.

- **Changing a value**

There are two ways to change the value currently highlighted on the screen: rotate the alpha dial or enter a new value through the ten-key numeric pad. In the latter case, the number you type appears on the screen on a blue background (instead of the normal yellow one) to indicate that it is only a temporary value. Either press the ENTER key to make the new value permanent (yellow background) or shift the cursor to discard the new value and return to the old.

Note: To enter a “-” value, start the number with “0”.

- **Selecting a submenu**

Some menus have additional or “sub” menus. Press the SHIFT key to summon the submenu to the display screen.

3 SONG PLAY

When the system has booted, it automatically displays the SONG PLAY screen to indicate that the S-50 is ready to play a song. Pressing the PLAY key, for example, will therefore start song #1.

Screen Layout

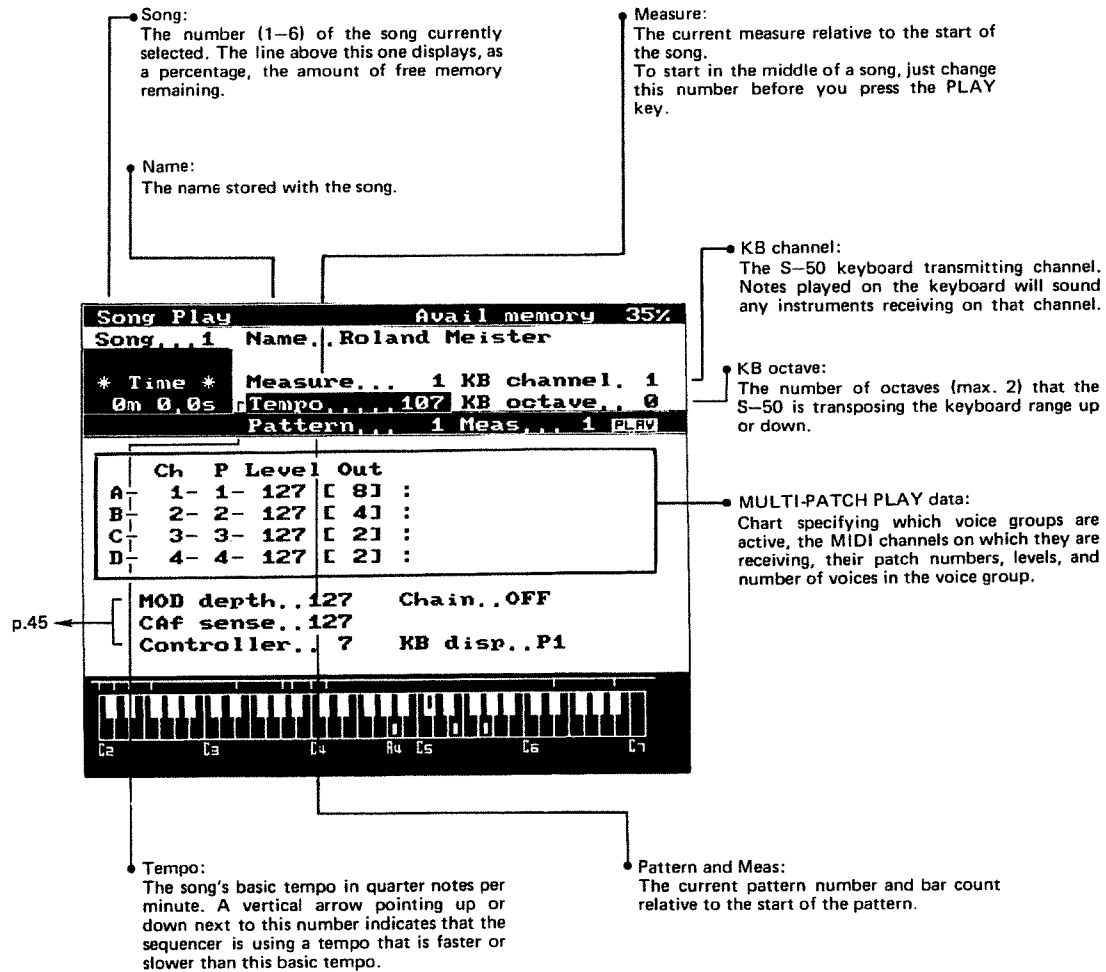

Figure 9 The SONG PLAY Screen

When the S-50 is playing a song, the word **PLAY** appears on the message line. It changes to **STOP** when the song ends.

- To stop the song in the middle, press the PLAY key.



- To restart from the beginning, press the -PAGE and PLAY keys.

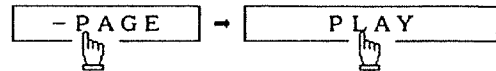

- To restart from the current bar, press the PLAY key.



- To continue from the exact position where you stopped, press the PATCH and PLAY keys.

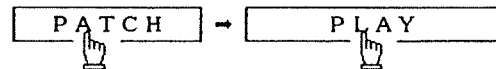

Note: The word **PATCH** appears on the message line of the screen when press the PATTERN key.

- To start from a particular bar:

Song Play		Avail memory	35%
Song... 1	Name.. Roland Meister		
* Time *	Measure... 1	KB channel.	1
0m 0.0s	Tempo..... 107	KB octave..	0
	Pattern... 1	Meas... 1	PLAY

- Shift the cursor to the "Measure" display.
- Rotate the alpha dial until the desired bar number appears.



- Press the PLAY key.

- To change the tempo:

Song Play		Avail memory	35%
Song... 1	Name.. Roland Meister		
* Time *	Measure... 1	KB channel.	1
0m 0.0s	Tempo..... 107	KB octave..	0
	Pattern... 1	Meas... 1	PLAY

- Shift the cursor to the "Tempo" display.
- Rotate the alpha dial until the desired tempo appears.

Figure 10 SONG PLAY Operation

Using a Foot Pedal to Play

A foot switch — a Roland DP-2 or BOSS FS-5U, for example — connected to the DP-2 jack in the PEDAL CONTROL section at the rear of the S-50 can substitute for the PLAY key. Holding the pedal down for over two seconds, however, resets the bar counter to 1, the beginning of the song.

Note: You may change the parameters on the screen at any time by shifting the cursor to a parameter and then either rotating the alpha dial or entering a number through the ten-key numeric pad. In the latter case, however, the change will not take effect until you press the ENTER key.

4 PATTERN WRITE

Songs are made up of patterns. This part of the software is for creating and editing these patterns.

To start: Press the EDIT key.

Note: Although the original pattern may be on disk, always remember that you are working with a copy in the S-50's memory. As long as you do not erase the copy on disk, you can reload the original at any time and start over.

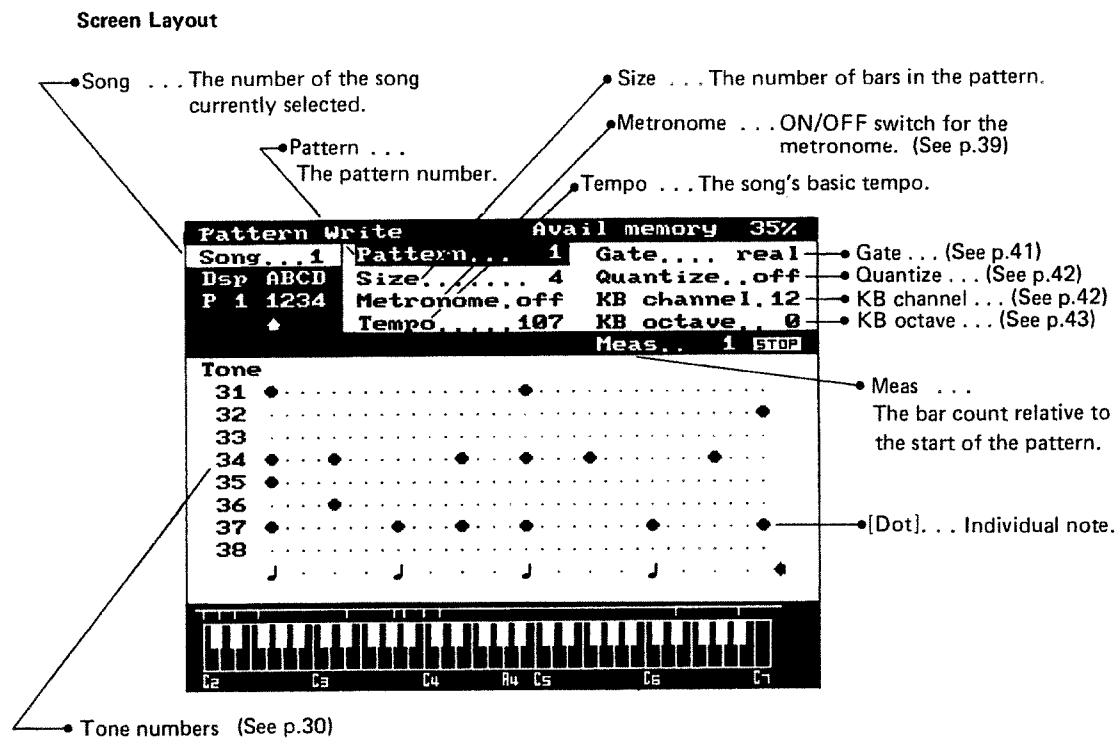

Figure 11 The PATTERN WRITE Screen

1. PATTERN PLAY

- Move the cursor to the **Pattern** display and enter the pattern number.
- Press the PLAY key to start the pattern. When the software reaches the end of pattern, it automatically starts over from the beginning.

When the S-50 is playing a pattern, the word **PLAY** appears on the message line.

- To stop the pattern in the middle, press the PLAY key.



- To restart from the beginning, press the PLAY key.



- To continue from the exact position where you stopped, press the PATCH and PLAY keys.

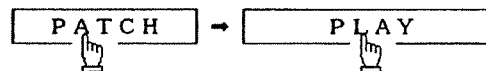

Note: The word **PATCH** appears on the message line of the screen when press the PATCH key.

- To change the tempo:

(1) Shift the cursor to the Tempo display.

Pattern Write		Avail memory 35%
Song... 1	Pattern... 1	Gate... real
Dsp ABCD	Size..... 4	Quantize..off
P 1 1234	Metronome.off	KB channel.12
▲	Tempo.....107	KB octave.. 0

(2) Rotate the alpha dial until the desired tempo appears.

Figure 12 Pattern Play Operation

2. Changing the Screen

The PATTERN WRITE screen can only display one tone bank and half the MIDI channels at a same time.

To change tone bank display, press the PATCH key and the corresponding number key.

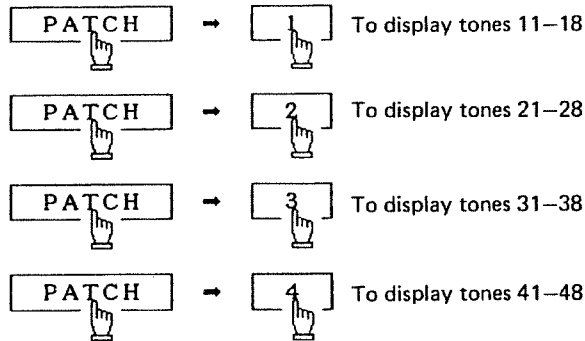

Figure 20 Changing Tone Banks

To switch between the two sets of MIDI channels, press the PATCH key and the +PAGE or -PAGE key.

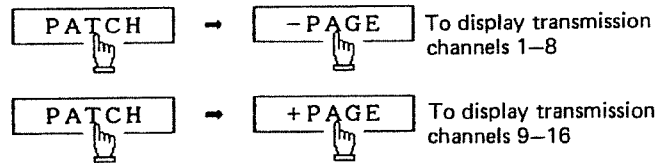
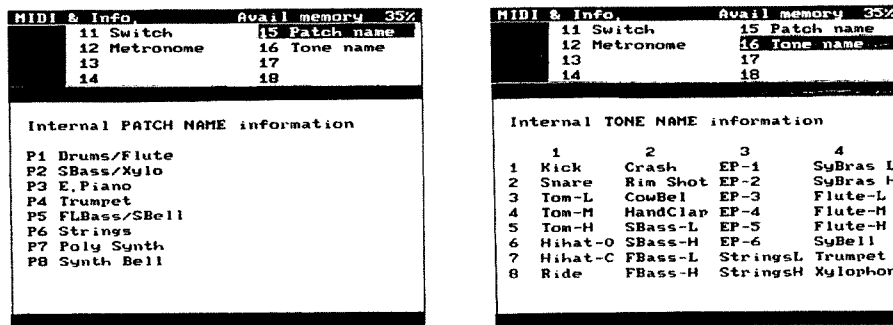

Figure 25 Changing the MIDI Channel Display

Checking Patch and Tone Names

The DIRECTOR-S software provides a quick and easy way to check patch and tone names even as you are editing.



Checking Patch Names

Figure 13

Checking Tone Names

- (1) Press the MIDI key.
- (2) Press P5 (Patch name) or P6 (Tone name).
- (3) Press the EDIT key to return to the PATTERN PLAY screen.

3. MICROSCOPE Screen

The MICROSCOPE screen gives a detailed picture of the data stored in the pattern. This data includes not only the note data, but also such details as aftertouch, control changes, and tempo: The screen also allows you to insert, delete, or modify this data.

3.1 The MICROSCOPE screen



Pressing the EDIT key changes the lower part of the PATTERN WRITE screen to the MICROSCOPE screen. Pressing it a second time brings back the keyboard display.

Micro scope									
1	0	12	F	2	41	[15]	113	55	
1	48	12	D	2	38	[17]	72	15	
1	72	3	C	4	60	[23]	95	13	
Meas	CPT	Ch	Note	No.			Vel.	Gate	

Figure 14 MICROSCOPE Screen Layout

You may scroll through the data with either the UP and DOWN CURSOR keys or the alpha dial. In the latter case, each note sounds as you scroll.

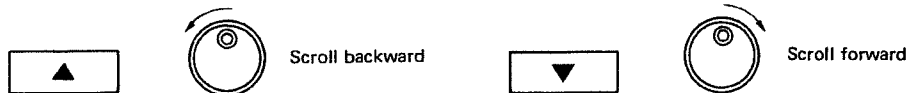

Screen Layout

- Meas** The bar count relative to the start of the pattern.
- CPT** Clock pulse time relative to the start of the bar (0). The timing is fixed at 96 pulses per quarter note for all tempos.
- Ch** MIDI channel number.
- Note No.** Note number in both octave and key number notation. Middle C, for example, is C4 and No. 60.
- Vel.** Velocity (1–127) of the recorded note. The relationship between this number and the loudness depends on the sound source.
- Gate** Note length, from the time the key is pressed until it is released. The timing unit is fixed at the same 96 pulses per quarter note as the CPT.
- [1 1]** Tone number. For internal sound sources, this is the number of the first tone for the corresponding patch. For external MIDI sources, this column is always "***".

PATTERN WRITE

3.2 CPT units

The DIRECTOR-S unit for timing notes is the clock pulse. The timing is fixed at 96 pulses per quarter note for all tempos.

Example 1	 ↑ ↑ ↑ ↑ ↑ ↑ ↑ ↑ ↑ ↑ ↑ ↑ ↑ ↑ ↑ ↑ 0 24 48 72 96 120 144 168 192 216 240 264 288 312 336 360
Example 2	 ↑ ↑ ↑ ↑ ↑ ↑ ↑ ↑ ↑ ↑ ↑ ↑ ↑ ↑ ↑ ↑ 0 32 64 96 128 160 192 224 256 288 320 352

Length of individual notes

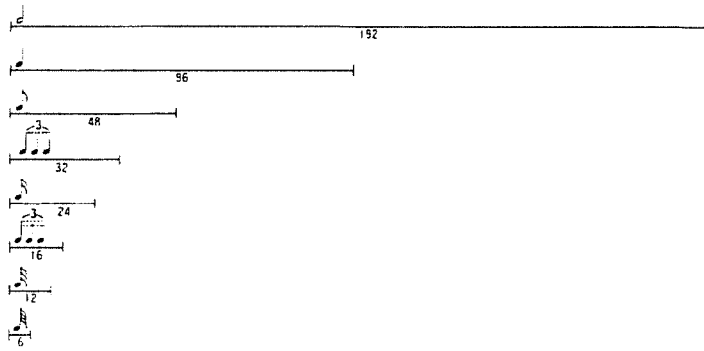

Figure 15 CPT Units

3.3 The ALL display

The MICROSCOPE screen offers a choice of two types of data displays: ALL and SEL. If the word **SEL** appears next to the label **Microscope**, use the following procedure to change to the more complete display.

- (1) If necessary, press the **EDIT** key to switch to the **MICROSCOPE** display.
- (2) Press the **SHIFT** key to display the submenu.
- (3) Use the **UP** arrow key to shift the cursor to **ALL**.
- (4) Press the **ENTER** key.

After the above procedure, the middle portion of the screen displays all types of data.

Note: An alternative procedure is to press the **PATCH** and **EDIT** keys.

3.4 The SEL screen

The software also allows you to concentrate on a particular type of data.

- (1) If necessary, press the **EDIT** key to switch to the **MICROSCOPE** display.
- (2) Press the **SHIFT** key to display the submenu.
- (3) Use the **DOWN** arrow key to shift the cursor to **SEL**.
- (4) Use the alpha dial to select the data type.

NOTE . . . Notes.

PAf Polyphonic aftertouch data.

CC Control change data.

PG Program change data.

CAf Channel aftertouch data.

PB Pitch bender data.

Tempo Tempo change data.

- (5) Press the **ENTER** key.

Note: Pressing the **SHIFT** key instead cancels the operation.

After the above procedure, the word **SEL** appears next to the label **Microscope**, and the middle of the screen shows only the selected type of data.

3.5 Modifying data

The MICROSCOPE display provides two functions for changing the data: **Change event** and **Change CPT**. These change the content and the timing respectively.

- (1) Press the LEFT arrow key for "Change CPT" or the RIGHT one for "Change event".

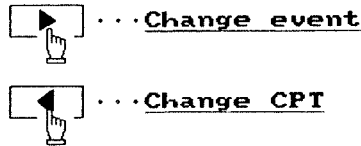

Micro scope				Change event				
1	0	12	F 2	41	[15]	113	55	
◆	1	48	12	D 2	38	[17]	72	15
	1	72	3	C 4	60	[23]	95	13
Meas CPT Ch Note No,				Vel, Gate				

Change CPT

Change event

Figure 16 Modifying MICROSCOPE Data

- (2) Use the CURSOR keys to select a data item.
- (3) Use the ten-key numeric pad or alpha dial to change the value. (In the former case, you have to press the ENTER key after the number.)
- (4) Alternatively, you can change the note number or velocity by playing a note on the S-50 keyboard. If the cursor is in the Note No. column, the key's note number replaces the old value. If it is in the Vel. column, only the velocity value changes.
- (5) If you wish to modify other items, go back to step 2.

Note: Shifting the cursor after changing a value makes the change permanent.

- (6) Press the ENTER key to store the data and return to the normal MICROSCOPE display. If you do not wish to store the data, press the EDIT key instead.

3.6 Deleting data

The MICROSCOPE display also provides a function for deleting lines of data.

- (1) Use the UP and DOWN CURSOR keys or the alpha dial to shift the unwanted line to the middle of the screen.
- (2) Press the "0" key on the ten-key pad.

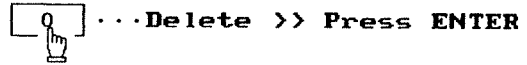

Micro scope  Delete >> Press ENTER									
1	0	12	F	2	41	[15]	113	55	
◆	1	48	12	D	2	38 [17]	72	17	
1	72	3	C	4	60	[23]	95	13	
Meas	CPI	Ch	Note	No.			Vel.	Gate	

Figure 17 Deleting MICROSCOPE Data

Note: Press the EDIT key to cancel.

- (3) Press the ENTER key to delete the data.

Note: Press the EDIT key to cancel.

- (4) If desired, return to step 1.
- (5) Press the ENTER key to return to the normal MICROSCOPE display.

3.7 Inserting data

The MICROSCOPE display also provides a function for inserting lines of data.

- (1) Use the UP and DOWN CURSOR keys or the alpha dial to display the desired position in the middle of the screen.
- (2) Press the "1" key on the ten-key pad.

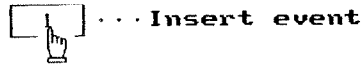

Micro scope	ALL	Insert event
▶	1 87	
Meas	CPT	Ch Note No., Vel, Gate

Figure 18 Inserting MICROSCOPE Data

- (3) Use the alpha dial or ten-key pad to specify the timing (in CPT units) for the new line.
- (4) Press the ENTER key to summon the data entry menu.
- (5) Shift the cursor to the desired type of data.
- (6) Press the ENTER key to store the default value.
- (7) Press the ENTER key to return to the normal MICROSCOPE display.
- (8) Press the EDIT key to turn off the MICROSCOPE display.

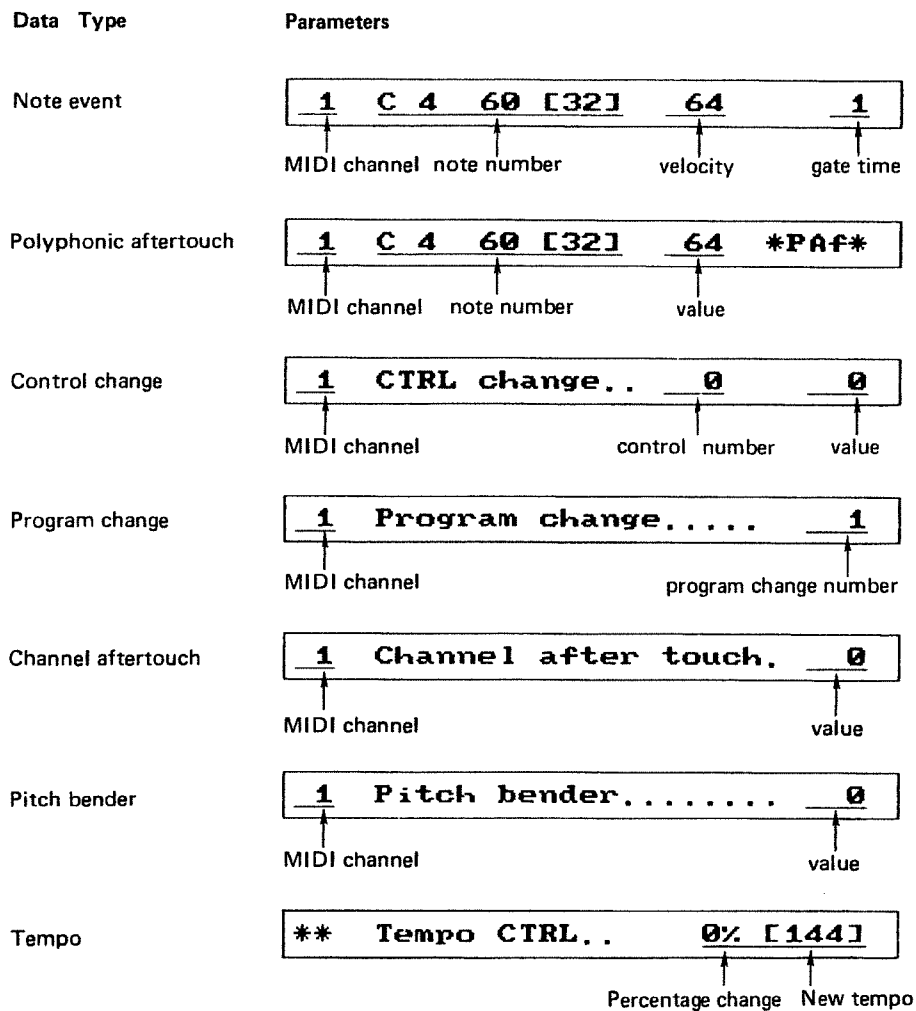

Figure 19 Entering New Data

Note: Specify the new tempo as a percentage relative to the current tempo, which appears at the top of the screen. The software then automatically calculates the tempo and displays it to the right of the percentage.

Note: During playback, an arrow on the display indicates when the tempo is faster (UP) or slower (DOWN) than the base tempo.

4. TONE SELECT Screen

This screen allows you to select a particular tone, play it on the S-50 and edit its data with the MICROSCOPE display.

4.1 Selecting a tone

- (1) If necessary, change the tone bank displayed on the PATTERN WRITE screen.

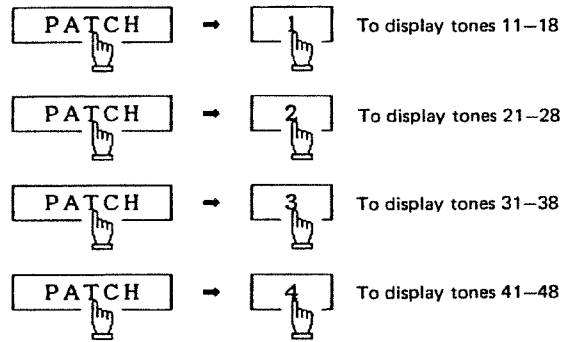

Figure 20 Changing Tone Banks

- (2) Select a tone with the PATCH keys (P1–P8). (An arrow appears next to the selected tone.)

Example

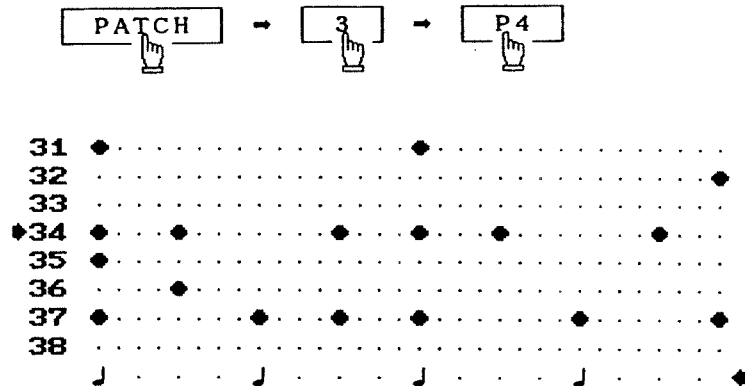

Figure 21 Selecting a Tone

- (3) To cancel, press the same PATCH key a second time.

Note: If the patch key mode is V-SW, X-Fade, or V-Mix, the software will select the 1st tone. (Refer to pp. 39–40 in your S-50 Version 2.00 Owner's Manual.)

Note: If the same channel uses more than one patch, the software will select the tone on the first available channel – for example, A if voice groups A and B are in use and B for groups B, C, and D.

4.2 Playing the tone

Press the PLAY key to play the tone data.

Note: You may select a different tone while the current one is still playing.



Figure 22 Playing the Data

4.3 Erasing the Tone Data

Press the REC and PLAY keys to simultaneously play the tone and erase the data.

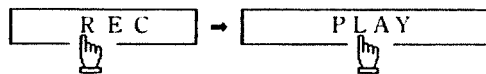

Figure 23 Erasing the Data

Press the PLAY key a second time to stop.

Note: If you wish to retain data at the beginning, select a tone, press the PLAY key, and then press the REC key at the point you wish to start erasing.

4.4 The tone MICRO SCOPE screen

Press the EDIT key to display the tone data in the MICROSCOPE format.



Figure 24 Editing Data

5. CHANNEL SELECT Screen

This screen allows you to select a particular channel, play it on the S-50, and edit its data with the MICROSCOPE display.

5.1 Selecting a channel

- (1) If necessary, change the set of channels displayed on the PATTERN WRITE screen.

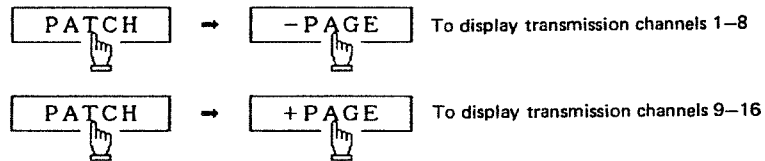

Figure 25 Changing the MIDI Channel Display

- (2) Select a channel with the PATCH keys (P1-P8). (An arrow appears next to the selected channel.)

Example

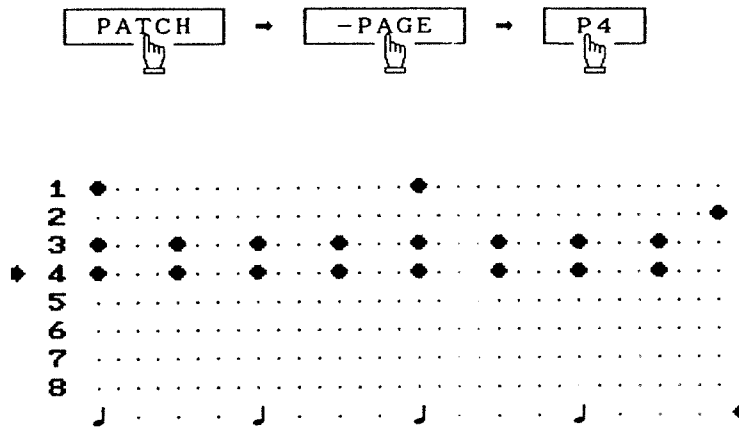

Figure 26 Selecting a Channel

- (3) To cancel, press the same PATCH key a second time.

5.2 Playing the channel data

Press the PLAY key to play the channel data.

Note: You may select a different channel while the current one is still playing.



Figure 22 Playing the Date

5.3 Erasing the channel data

Press the REC and PLAY keys to simultaneously play the channel and erase the data.

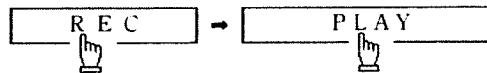

Figure 23 Erasing the Data

Press the PLAY key a second time to stop.

Note: If you wish to retain data at the beginning, select a channel, press the PLAY key, and then press the REC key when you wish to start erasing.

5.4 The channel MICROSCOPE screen

Press the EDIT key to display the channel data in the MICROSCOPE format.

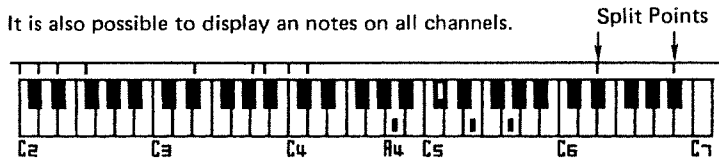

Figure 24 Editing Data

6. Checking Patch Numbers and Note Data

Just above the keyboard on the display are marks indicating the patch split points for the S-50 keyboard. This part of the display normally displays just the notes played on the keyboard channel.

It is also possible to display an notes on all channels.



- (1) Press the PATCH key.
- (2) Press the "0" on the ten-key numeric pad

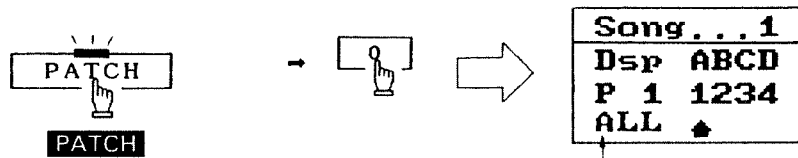

Note: The word ALL appears in the box.

- (3) Repeat the above procedure to return to the single-channel display for the keyboard.

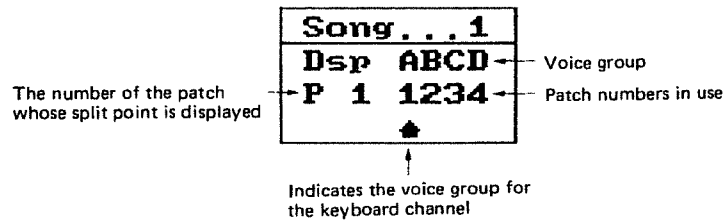

This information is also displayed on the SONG PLAY screen.

```

KB disp..P1 [ALL]
    
```

If you choose ALL (all channels) on the PATTERN WRITE screen, the SONG PLAY screen also shows all notes on its representation of the keyboard.

Note: If the channel uses more than one patch, the software will display the split point for the first available voice group — choosing A over B, for example.

7. Preparing to Record

DIRECTOR-S allows you to simultaneously control a variety of sound sources on 16 separate channels. Its overdubbing capabilities also allow you to record the necessary data from the S-50 keyboard one channel at a time. In this example, we will use one external MIDI sound source and the S-50's VOICE MODE 1, which distributes the 16 internal voice available among four channels so that the channels use 8, 4, 2, and 2 voices respectively.

Note: This distribution is standard for Roland products.

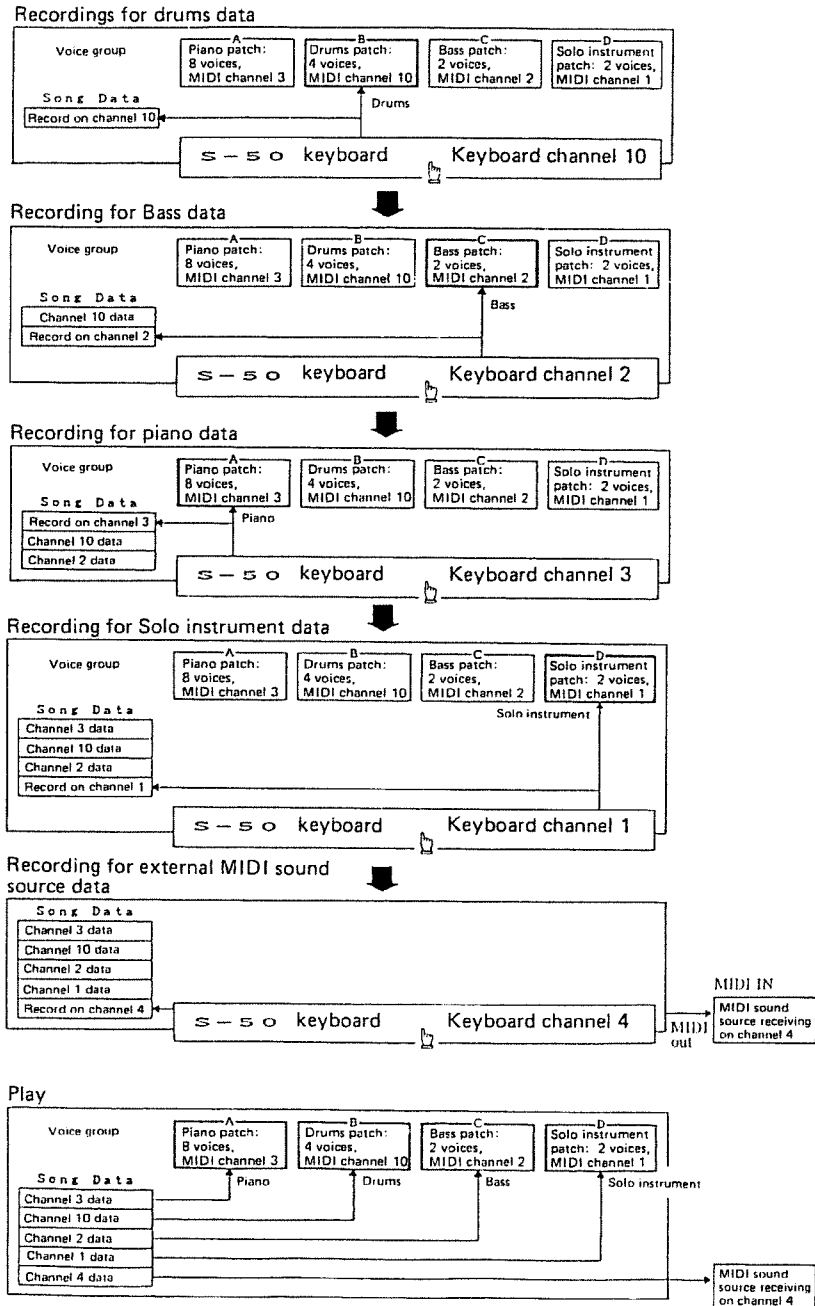

Figure 29 Preparing to Record

7.1 Clearing data

The S-50 has enough memory for six songs. Before you can record a new song, you must either select an empty song or erase the data of the current song.

Call an empty song

- (1) Press the AUX key for the SONG PLAY screen.
- (2) Press the SHIFT key to pop-up the submenu.
- (3) Rotate the alpha dial to change the song number.
- (4) Press the ENTER key.

Note: If you have just booted the software, only the first song area contains data.

Note: Pressing the DISK key gives you a listing of the songs currently available and how much of the available memory space each one occupies. The notation 0% indicates an empty song.

Erasing a Song

The following procedure erases all data (song name, pattern datas, and pattern setting) of the current song. At this point, you may therefore wish to save the old version to disk. (See SONG SAVE on p.59)

- (1) Press the FUNC key for the SONG WRITE screen.
- (2) Press the SHIFT key to pop-up the submenu.
- (3) Shift the cursor to "All clear".
- (4) Press the ENTER key to complete the erasure.

Note: Press the SHIFT key to cancel.

Erasing a Pattern

The following procedure is for erasing an entire pattern.

- (1) Press the EDIT key to display the PATTERN WRITE screen.
- (2) Press the SHIFT key to pop-up the submenu.
- (3) Shift the cursor to "All clear" and press the ENTER key.
- (4) Press the ENTER key to complete the erasure.
- (5) Answer the prompt "Are you sure?" with either the ENTER or SHIFT key (to proceed or cancel, respectively).

7.2 Specifying the sound source

For best results, you should record each channel with the desired sound source attached so that you can check the tone and volume with your own ears. Before proceeding, therefore, load the appropriate sound data into the S-50 or set up the MIDI instrument.

In the former case, the CHANGE SYSTEM command (See p. 68.) allows you to change to the S-50 Sampling Keyboard Ver. 2.00 software without having to turn off the S-50. The SONG PLAY screen also provides the MULTI-PATCH PLAY function.

7.3 MIDI and Recording SWITCH menu

Press the MIDI and P1 keys to display the MIDI SWITCH menu.

MIDI & Info.		Avail memory 35%
11 Switch	15 Patch name	
12 Metronome	16 Tone name	
13	17	
14	18	
Sync clock	INT
Transmit	ON
Receive	ON
* Recording Switch *		
Poly after touch	OFF
Control change	OFF
Program change	OFF
Channel after touch	..	OFF
Pitch bender	OFF

Figure 30 MIDI and Recording Switch Menu

The TRANSMIT and RECEIVE switches must be ON to use equipment connected to the MIDI IN and MIDI OUT jacks.

MIDI TRANSMIT Switch

Make sure that the TRANSMIT switch is ON so that the S-50 transmits to the external MIDI sound source.

Note: The interface transmits its clock signal even when this switch is OFF.

MIDI RECEIVE Switch

Turn the RECEIVE switch ON if you wish to control the S-50 from a MIDI master keyboard, Roland GM-70, Roland MC-500, or equivalent equipment. The S-50 ignores messages when it is OFF.

Note: The interface acts on the MIDI clock signal even when this switch is OFF. (See MIDI SYNC CLOCK on p. 73 for an explanation of the SYNCH CLOCK switch.)

Recording Switches

The memory available for patterns is limited. Frequent use of the pitch bender and aftertouch functions greatly increases the amount of data that DIRECTOR-S must store and fills the memory that much more quickly. Shutting off unnecessary functions saves storage space and therefore gives you the maximum possible recording time.

Note: The software stores these switch settings with the song data.

7.4 Metronome menu

A metronome is a useful adjunct to both playing patterns and recording them. The software does not limit you to a particular sound source. You are free to choose an internal source or an external MIDI source. You can then specify the channel, note number, and velocity (which ultimately determines the volume).

- (1) Press the MIDI and P2 keys to display the METRONOME menu.

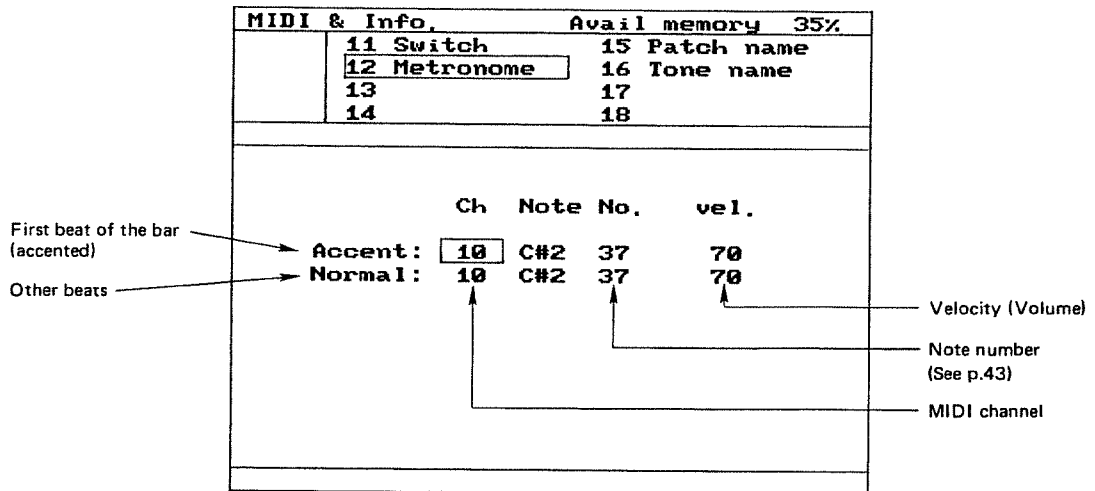

Figure 31 METRONOME Display

- (2) Enter the channel numbers, note numbers, and velocities for the accent (the first beat of the bar) and the other quarter notes.
- (3) Press the EDIT key to return to the PATTERN WRITE screen.
- (4) To turn the metronome on or off, shift the cursor to the word "Metronome" and rotate the alpha dial.

Note: When the metronome switch is ON, the S-50 sends the appropriate notes over the MIDI channel specified in step 2.

Note: The software stores the metronome settings together with the song data.

7.5 Specifying the time scale

The software allows you to assign a separate time scale to each pattern. The PATTERN WRITE screen is then scaled to display exactly one bar, and the bars all are the same signature.

- (1) Press the SHIFT key to display the submenu.
- (2) Shift the cursor to "Scale select" and rotate the alpha dial to change the time scale.

Note: The length of a quarter note is the same for all time scales.

- (3) Shift the cursor to "Last step" and rotate the alpha dial to change the length of the bar.

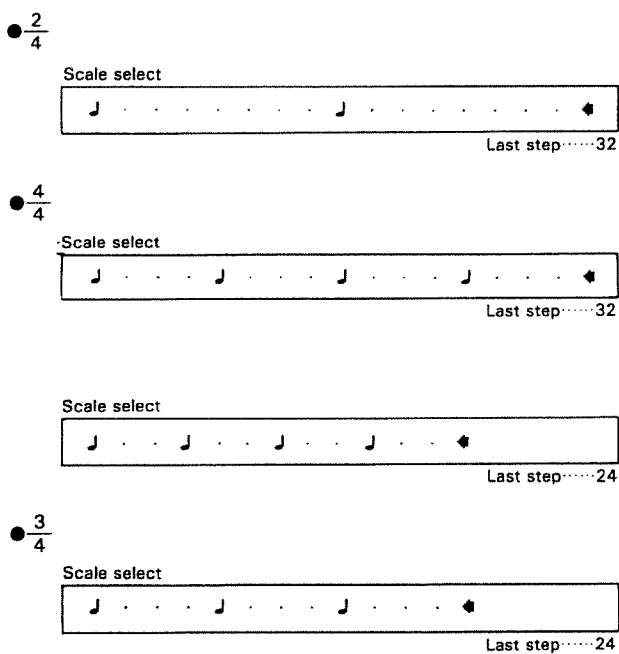

Figure 32 Specifying the Time Scale

Note: Reducing the bar length with either of the above two steps automatically shifts the extra data into subsequent bars, but any data shifted beyond the final bar (as determined by the SIZE parameter described below) is lost. Once you switch to the MICROSCOPE screen, another pattern, or another screen. Otherwise increasing the bar length bring the overflow back.

- (4) Press the SHIFT key to hide the submenu.

7.6 PATTERN WRITE Parameters

Pattern Write		Avail memory 35%
Song...1	Pattern... 1	Gate... real
Dsp ABCD	Size..... 4	Quantize..off
P 1 1234	Metronome.off	KB channel.12
↑	Tempo....107	KB octave.. 0
		Meas., 1 STOP

Parameters

Figure 33 PATTERN WRITE Parameters

SIZE

A pattern may be anywhere between 1 and 16 bars long, but there is a limit of 200 steps. (One step corresponds to one line on the MICROSCOPE screen.) Be careful not to make the pattern too long and too complicated. You may run out of memory.

METRONOME

Turning this switch on provides a metronome sound for playback and recording. (See p. 39 for the relevant procedures.)

TEMPO

This figure gives the base tempo for the entire song. Any change therefore affects all other patterns as well.

Note: You may change this value for recording, but it is not recorded as data. If you wish to change the tempo partway through a pattern, use the MICROSCOPE screen. (See p. 28.)

GATE

The software adjusts the **gate time**, the gap between the times when you press the key and when you release it, so that it is an even multiple of this value in CPT units. (See p. 24 for the definition of these unit.) A value of 96, for example, makes every note a quarter note or multiple thereof. The special value "real" specifies real-time recording, in which the sequencer records each note exactly as it is played.

PATTERN WRITE

QUANTIZE

Real-time recording uses a time unit that corresponds to 1/96 of a quarter note. This function allows you to smooth the recording by forcing the "key on" events to align at intervals larger than this base unit.









1/2 . . .		Half note
1/4 . . .		Quarter note
1/8 . . .		Eighth note
/12 . . .		Eighth-note triplets
/16 . . .		Sixteenth note
/24 . . .		Sixteenth-note triplets
/32 . . .		Thirty-second note
/64 . . .		Sixty-fourth note

Figure 34 Quantize Function Units

Note: The QUANTIZE function is for recording only. It cannot handle existing data.

KB CHANNEL

The sequencer transmits any notes played on the S-50 keyboard over this channel. If it is recording, it stores this data under the same channel number.

KB OCTAVE

The S-50's 61-key keyboard covers only five octaves (C2-C7). This function transposes the keyboard up to two octaves in either direction so that the sequencer can record key numbers over the range C0-C9.

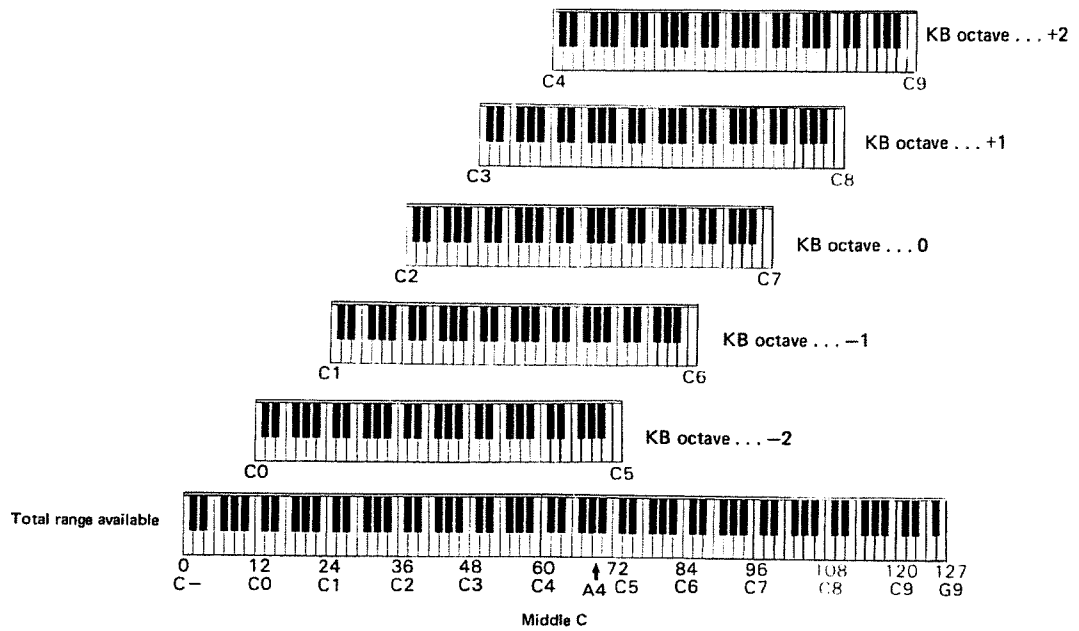

Figure 35 KB OCTAVE Function

8. Recording a Pattern

To start recording, press the REC and PLAY keys. Alternatively, press the PLAY key to play back the current pattern and press the REC key at the point where you wish to record new material.



Press the PLAY key. (PLAY appears on the message line.)



Press the REC key. (REC appears on the message line.)

Thereafter, the REC key serves a PUNCH IN/PUNCH OUT function, switching the sequencer between recording (REC) and playback (PLAY).

Figure 35.1 Recording a Pattern

Note: A pattern may have up to 200 steps. If the current pattern reaches 200 steps or the memory available for the current song drops to 0%, an asterisk appears next to the label **Avail memory**.

A foot switch – a Roland DP-2 or BOSS FS-5U, for example – connected to the DP-2 jack in the PEDAL CONTROL section at the rear of the S-50 can substitute for the REC key.



Note: You may change almost any parameter at any time during playback recording.

Pattern Write		Avail memory 35%
Song... 1	Pattern... 1	Gate... real
Dsp ABCD	Size..... 4	Quantize.. off
P 1 1234	Metronome off	KB channel. 12
▲	Tempo... 107	KB octave. 0
		Meas.. 1 STOP

You may change these parameters while recording.

Figure 36 Changing Parameters

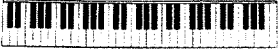
The sequencer allows you to record the following in real time with your S-50 keyboard.

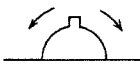
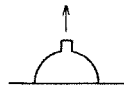
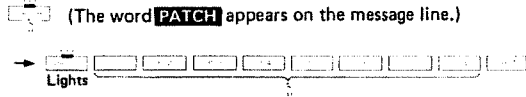
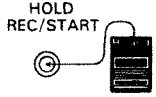
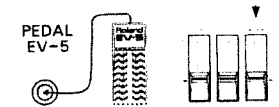
Procedure		Data Transmitted and Recorded
	Play a note on the keyboard.	Note data
	Press harder on the keyboard.	Channel aftertouch data (See Note 2.)
	Shift the BENDER/MODULATION wheel to the left or right.	Bender data
	Press the BENDER/MODULATION wheel back.	Modulation data (Control change No. 1) (See Note 1.)
	(The word PATCH appears on the message line.)	Program change data (No. 1–8)
	Depress a foot switch plugged into the HOLD/REC START jack.	Hold data (Control change No. 64)
	Move a control knob or Depress a foot switch plugged into the EV-5 jack.	Control change data

Notes:

1. There is a parameter controlling the size of the modulation produced by shifting the lever all the way to one side. The highest possible setting is 127.
2. The similar parameter controls the amount of aftertouch produced by pressing harder on the keyboard while the SONG PLAY function is active. The highest possible setting is 127.
3. The SONG PLAY function allows you to assign the control dial a control change number in the range 0–95. The control change command uses 0 for the minimum and 127 for the maximum setting. The sequencer then ignores any setting stored with the sound data by the Ver. 2.00 software (FUNC menu No. 12).

(1) **MOD depth..127**
 (2) **CAf sense..127**
 (3) **Controller.. 7**

Figure 37 Recording a Pattern

Note: An expression pedal attached to the EV-5 jack serves the same function as the control dial. Plugging in the pedal automatically disables the control dial.

Note: The sequencer does not record data other than notes unless the corresponding recording switch is on. (See p. 38.) Similarly, the S-50 sound sources do not respond to these other types of data unless the voice groups have the corresponding receiving switches on. (Refer to your S-50 Version 2.00 Owner's Manual.)

9.Editing Data

The PATTERN WRITE submenu provides several functions which allow you to edit the pattern data for each channel.

General Procedure

- (1) Turn off the MICROSCOPE display (if present) and press the SHIFT key to display the submenu.

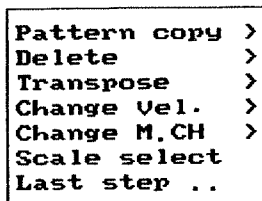

Figure 39 PATTERN WRITE Submenu

- (2) Shift the cursor to the desired function and press the ENTER key.
- (3) Set the parameters required by the function and press either the ENTER or SHIFT key to proceed or cancel, respectively.

9.1 PATTERN COPY

This function allows you to copy the data from another pattern.

Select the source pattern and press the ENTER key.

Pattern copy	
From :	Pattern, 1 [size, 8]

Figure 40 PATTERN COPY

NOTE – Note data.

PAf – Polyphonic aftertouch data. The software allows you to assign effects to individual keys.

CC – Control change data.

PG – Program change data.

CAf – Channel aftertouch data. The software allows you to assign effects to individual channels.

PB – Pitch bender data.

9.2 DELETE

This function allows you to delete portions of the current pattern.

Delete	
Select:	Ch, ALL Status, ALL Tone, **

Figure 41 DELETE

9.3 TRANSPOSE

This function allows you to transpose notes up and down in units of semi-tones.

Transpose	
Change:	Bias, 0
Select:	Ch, ALL Status, NOTE Tone, ALL

Figure 42 TRANSPOSE

9.4 CHANGE M. CH

This function allows you to modify the MIDI channel numbers stored with the data.

Micro scope ALL								
1	0	12	F	2	41 [15]	113	55	
•	1	48	12	D	2	38 [17]	72	15
	1	72	3	C	4	60 [23]	95	13
Meas	CPI	Ch	Note	No.		Vel	Gate	

Figure 43 CHANGE M. CH

Note: At this point, you may wish to save the edited version to disk. (See SONG SAVE on p. 62.)

9.5 CHANGE VEL.

This function allows you to change note velocities.

The velocity corresponds to the loudness of a note. A dynamic keyboard such as the S-50 produces both a note number and a velocity in the range 1–127. A keyboard that does not have this capability gives all notes a velocity of 64. The MICROSCOPE display lists the recorded values in its **Vel.** column.

Although a higher value generally produces a louder note, the relationship is usually not linear. It depends instead on the sound source's velocity curve.

A powerful addition to this function is the ability to rescale velocity values with slope and bias specifications.

Slope — This parameter allows you to either accentuate or suppress the rate of velocity change. A value of 1.0 produces no change.

Bias — This parameter raises or lowers the velocity value by the amount specified.

Change Velocity	
Change:	Slope, 1.0 Bias, 0
Select:	Ch, ALL Status, NOTE Tone, ALL

Figure 45 Velocity Slope and Bias

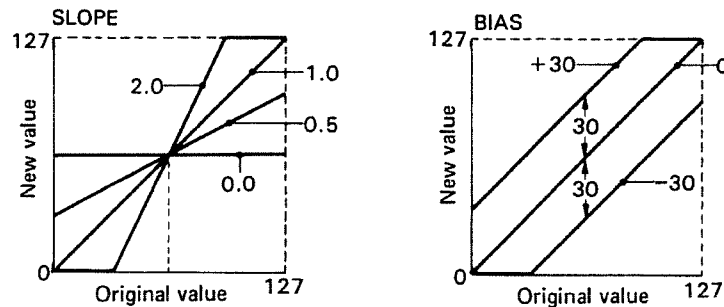

Figure 44 CHANGE VEL.

$$y = ax + b$$

where y = velocity after change
 x = velocity before change
 a = **Slope**
 b = **Bias**

Warning: Careful examination of the upper right and lower left corners of these graphs will show you that this type of rescaling is not reversible at the extreme ends of the velocity range. We strongly recommend, therefore, that you always work with a copy instead of the original data.

The above procedures allow you to create patterns. You can now join these patterns together to form songs. The next chapter tells you how.

5 SONG WRITE

The SONG WRITE screen provides functions for joining patterns together to form a song and then assigning a name to the result. To start, press the FUNC key to display the SONG WRITE screen.

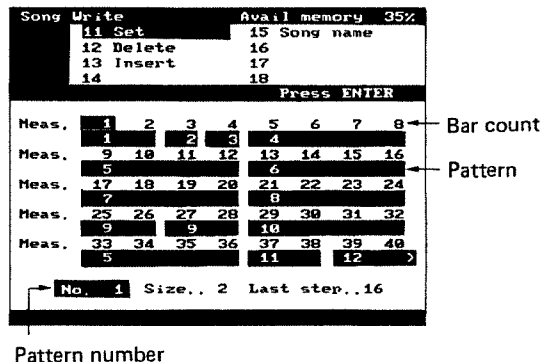

Figure 46 SONG WRITE Screen

The menu at the top of the screen provides three functions (SET, DELETE, and INSERT) for building a song from patterns and one (SONG NAME) for giving the result a name.

1. SET

This function joins patterns together to form a song. (See Figure 47.)

- (1) Press the P1 key to activate the function.
- (2) Shift the cursor to the desired bar.

Note: Use the LEFT and RIGHT keys to move one pattern (or bar) at a time and the +PAGE and -PAGE keys to jump 32 bars at a time.

- (3) Specify the pattern number by rotating the alpha dial or first typing the number and then pressing the ENTER key.
- (4) Press the ENTER key to insert the pattern beginning at that bar. If another pattern already occupies that bar, the software erases it (including any parts in previous bars).

- (5) Repeat steps 2--4 as often as necessary.

Note: The software treats any gaps between patterns as rests matching the bar length of the preceding pattern.

2. DELETE

This function deletes a particular pattern and moves all subsequent patterns up to fill the space. (See Figure 47.)

- (1) Press the P2 key to activate the function.
- (2) Shift the cursor to a bar within the unwanted pattern.

Note: Use the LEFT and RIGHT keys to move one bar at a time and the +PAGE and -PAGE keys to jump 32 bars at a time.

- (3) Press the ENTER key to delete the pattern and move the others up.

3. INSERT

This function moves all subsequent patterns down to make room and then inserts a particular pattern. (See Figure 47.)

- (1) Press the P3 key to activate the function.
- (2) Shift the cursor to the bar where the new pattern is to start.

Note: Use the LEFT and RIGHT keys to move one bar at a time and the +PAGE and -PAGE keys to jump 32 bars at a time.

- (3) Specify the pattern number by rotating the alpha dial or first typing the number and then pressing the ENTER key.
- (4) Press the ENTER key to insert the pattern and move the others down.

* In PATTERN WRITE mode, reducing pattern size simply fills the unused space with rests the length of the deleted bars. Increasing pattern size, on the other hand, overwrites subsequent patterns.

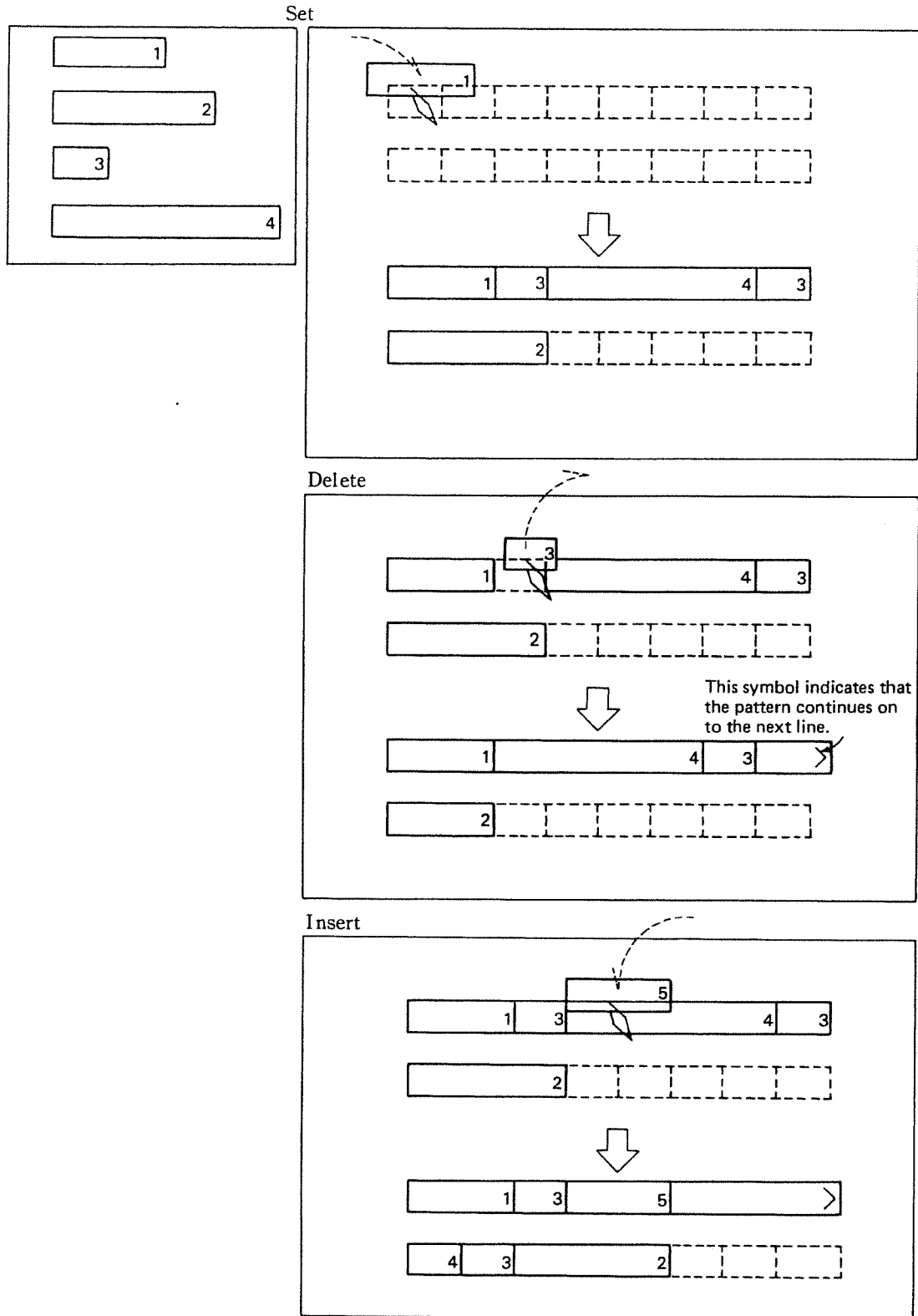

Figure 47 SONG WRITE Editing Functions

4. SET CLEAR

The SONG WRITE submenu contains two functions for erasing the current song data from the screen so that you can start afresh.

- (1) Press the SHIFT key to display the submenu.
- (2) Shift the cursor to SET CLEAR and press the ENTER key.

Note: The ALL CLEAR function clears not only the pattern setting, but also pattern datas used in the song and the song name.

5. SONG NAME

This function allows you to assign a 44-character name to the song. These names make it much easier to select songs for playback or loading from disk.

- (1) Press the P5 key to activate the function.

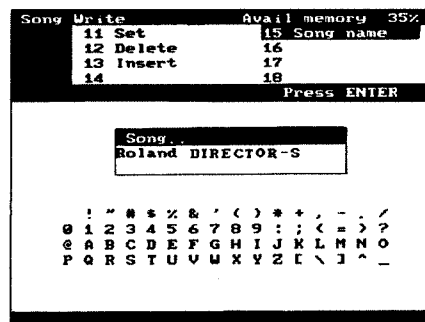

Figure 48 SONG NAME

- (2) Shift the cursor to the point where you wish to add characters.
- (3) Specify the character with the alpha dial or the ten-key pad.

SONG NAME Editing Keys

The keys on the ten-key pad provide not just numerals, but also the letters and symbols written just above and to the right on the S-50's panel. Repeatedly pressing a key cycles through the characters available.

The ENTER key produces a space.

If the cursor is on a letter, the SHIFT key switches between upper and lower case.

The -PAGE key deletes the letter under the cursor.

The +PAGE key inserts a space at the cursor.

6 DISK COMMANDS

There are 14 commands related to floppy disks and the floppy disk drive. These include SAVE, which copies data from the S-50's memory to a floppy disk, and LOAD, which operates in the reverse direction.

Write Protect Tab

The rear of the floppy disk case contains a **write protect tab**, a switch that prevents accidental erasures. We recommend that you normally leave this switch in its ON (PROTECT) position (next to the edge) and shift it to its OFF (WRITE) position only when you deliberately wish to write to the disk. (The ON position blocks all attempts to write new data to the disk.) Do not forget to return it to its ON position when you have finished writing data.

1. Two Types of Disk

DIRECTOR-S disks come in two types, or **formats**: The two disks included with the software are **Format A**. They contain the system software, one song, and sound data for the S-50.

The other type of disk, **Format B**, leaves off the sound data to free disk space for more songs – 36 in all. Since the S-50 only holds six songs at once, the songs are organized into **banks** of six songs each, and the software loads them one bank at a time.

Note: The only exception arises when you boot from a Format B disk. In that case, the system software loads only the first song in the first bank.

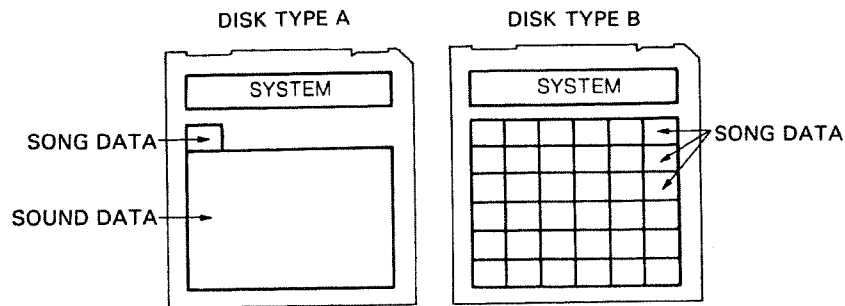

Figure 49 Two Types of Disk

You cannot save data to a new disk or one that has been used with some other equipment. You must first **format** it – that is, prepare it for use with the S-50. There are separate formatting commands for Format A and Format B disks.

Note: The only exception is the **BACKUP** command, which automatically formats the target disk (Format A) and then saves the S-50 sound data and the song which you specify.

2. Format A

The **FORMAT A** command copies the **DIRECTOR-S** software to the target disk and then prepares the remaining space to accept sound data and one song.

Note: This function requires that you connect your Owner's key to the **EXT CONTROLLER** connector at the rear of the S-50.

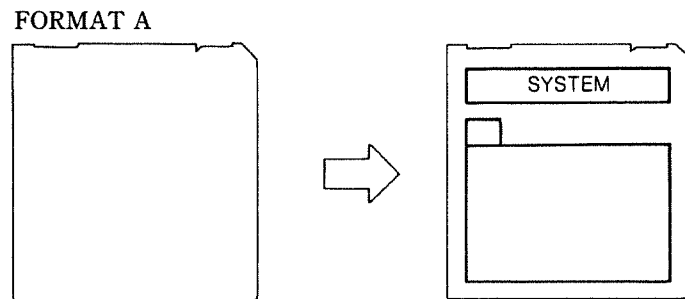

Figure 50 Format A Disk

You cannot save data to a new disk or one that has been used with some other equipment until you have formatted it for use with the S-50. A Format B disk is also incapable of storing sound data. If you wish to store sound data, you must first format the target disk as a Format A disk.

Note: Booting from a freshly formatted Format A disk yields a sequencer with absolutely no data in its memory.

- (1) Plug your Owner's key into the **EXT CONTROLLER** connector at the rear of the S-50.
- (2) Shift the **WRITE PROTECT** tab on the target disk to its **OFF** position.
- (3) Insert the disk into the drive.
- (4) Press the **DISK** key to display the **DISK COMMAND** menu.
- (5) Press the **+PAGE** and **P5** keys to select the **FORMAT A** function.
- (6) Press the **ENTER** key to start formatting.
- (7) Wait for the display to count down to **00** and the message on the screen to change from "Formatting . . ." to "Completed".

3. Format B

The **FORMAT B** command copies the **DIRECTOR-S** software to the target disk and then prepares the remaining space to accept up to 36 songs.

Note: This function requires that you connect your Owner's key to the **EXT CONTROLLER** connector at the rear of the S-50.

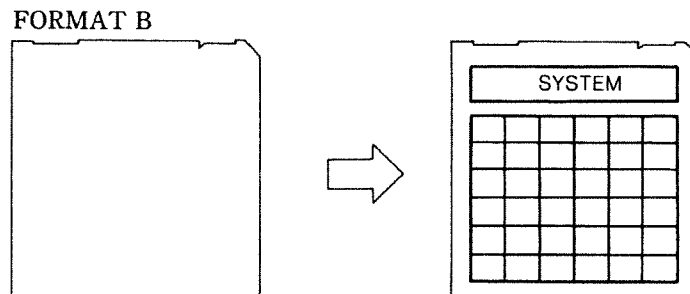

Figure 51 Format B Disk

You cannot save data to a new disk or one that has been used with some other equipment until you have formatted it for use with the S-50. A Format A disk is also incapable of storing more than one song. If you wish to make a disk a "song only" disk, you must first format it as a Format B disk.

- (1) Plug your Owner's key into the **EXT CONTROLLER** connector at the rear of the S-50.
- (2) Shift the **WRITE PROTECT** tab on the target disk to its **OFF** position.
- (3) Insert the disk into the drive.
- (4) Press the **DISK** key to display the **DISK COMMAND** menu.
- (5) Press the **+PAGE** and **P6** keys to select the **FORMAT B** function.
- (6) Press the **ENTER** key to start the formatting operation.
- (7) Wait for the display to count down to **00** and the message on the screen to change from "Formatting . . ." to "Completed".

4. BACKUP

This function automatically formats the target disk (Format A) and then saves the S-50 sound data and one song to it.

Note: This function requires that you connect your Owner's key to the EXT CONTROLLER connector at the rear of the S-50.

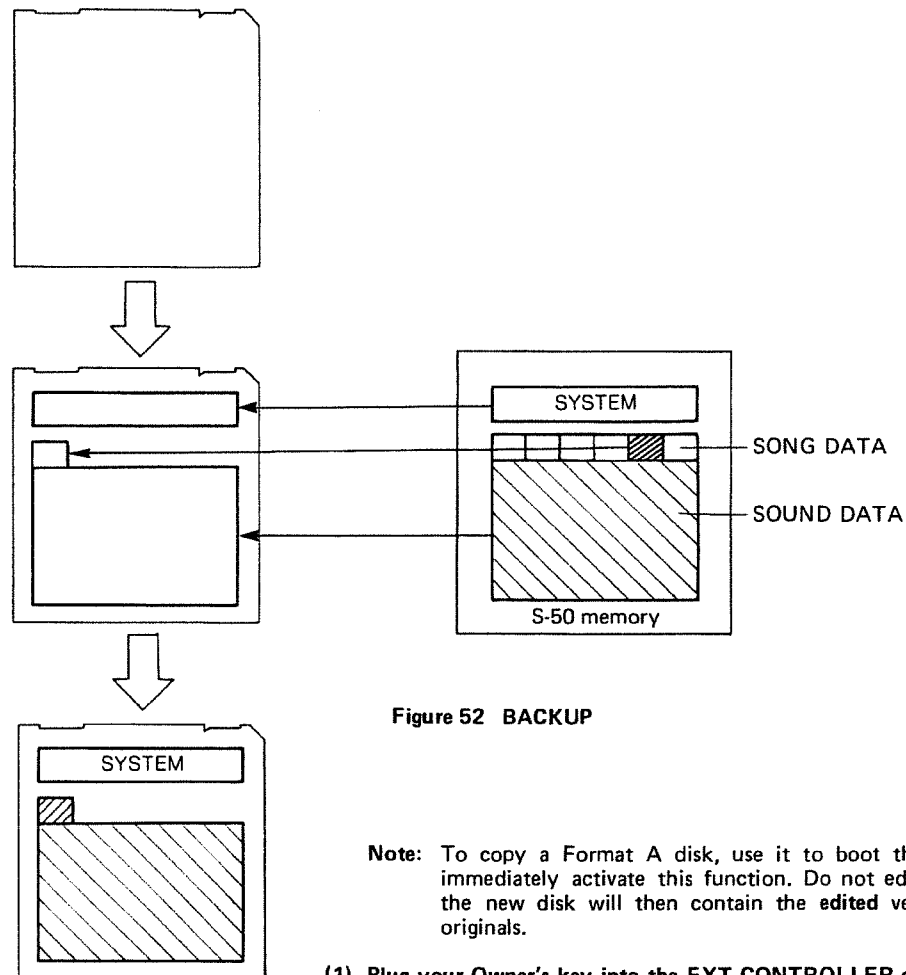

Figure 52 BACKUP

Note: To copy a Format A disk, use it to boot the system and then immediately activate this function. Do not edit any data because the new disk will then contain the **edited** versions and not the originals.

- (1) Plug your Owner's key into the EXT CONTROLLER connector at the rear of the S-50.
- (2) Press the DISK key to display the DISK COMMAND menu.
- (3) Press the +PAGE and P8 keys to select the BACKUP function.
- (4) Use the UP and DOWN cursor keys to select the song to copy.
- (5) Shift the WRITE PROTECT tab on the target disk to its OFF position.
- (6) Insert the disk into the drive.
- (7) Press the ENTER key to start the copy operation.
- (8) Wait for the display to count down to 00 and the message on the screen to change from "Formatting . . ." to saving and then to "Completed".

5. DISK CHECK

This function examines the disk in the drive and tells you if it is one of the four types that the software can read.

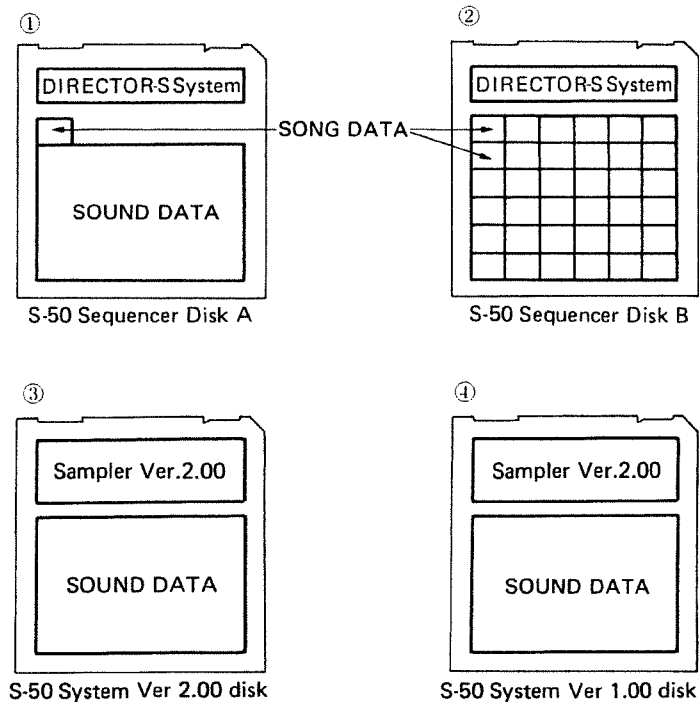

Figure 53 Four Possible Disk Types

- (1) Press the DISK key to display the DISK COMMAND menu.
- (2) Press the P5 key to select the CHECK DISK function.
- (3) Press the ENTER key.
- (4) Wait for the message on the screen to change from "Reading . . ." to "Completed".

When the function terminates, one of the following five messages will appear on the screen.

- (1) "S-50 Sequencer Disk A" – The screen will also list the name of the song as well as the disk label and disk memo stored with the sound data.
- (2) "S-50 Sequencer Disk B" – The screen will also list the names of the songs in the first bank. Use the number keys (1–6) to switch between banks.
- (3) "S-50 System Ver 2.00" – The screen will also list the disk label and disk memo stored with the sound data.
- (4) "S-50 System Ver 1.00" – The DIRECTOR-S software cannot read the sound data on this disk. Boot Ver 2.00 and use its CONVERT function to upgrade the disk to Ver 2.00. (Refer to P. 113 in your S-50 Version 2.00 Owner's Manual.)
- (5) "Not S-50 Disk!" – The disk has not been formatted for use with the S-50.

6. SONG SAVE

This function allows you to “save” a song – that is, copy it from the S-50’s memory to a floppy disk.

Note: This function requires that you connect your Owner’s key to the EXT CONTROLLER connector at the rear of the S-50.

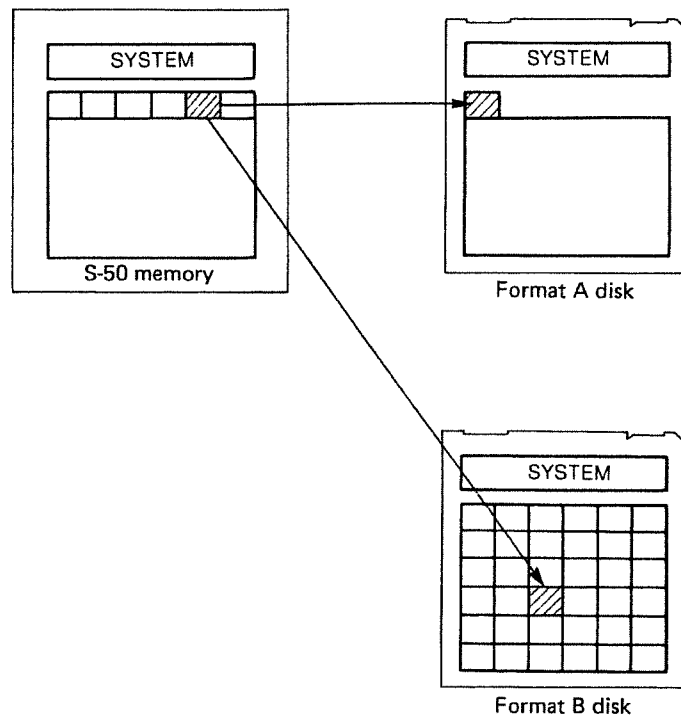

Figure 54 SONG SAVE

- (1) Plug your Owner’s key into the EXT CONTROLLER connector at the rear of the S-50.
- (2) Press the DISK key to display the DISK COMMAND menu.
- (3) Press the +PAGE key to select the SONG SAVE function.
- (4) Use the UP and DOWN cursor keys to select the song to copy.
- (5) Shift the WRITE PROTECT tab on the target disk to its OFF position.
- (6) Insert the disk into the drive.

DISK COMMANDS

- (7) Press the ENTER key to display the message

On disk, total * songs exist

(The software replaces the asterisk with the actual number of songs found).

Note: A song counts even when the display's [used] column lists its size as 0%. Although there may be no playback data, such a song always contains playback parameter settings.

- (8) (Format B disk only) Use the alpha dial or UP and DOWN cursor keys to select the song number and the number keys (1–6) to select the song bank.

Note: Since the software loads songs one bank at a time, it is a good idea to keep songs using the same sound data together in the same bank.

- (9) If the prompt "Overwrite OK?" appears, press either the ENTER key to proceed or the eject button on the drive to cancel. (For a Format B disk, moving the cursor also cancels the operation.)

Note: This prompt appears only if the target area of the disk already contains data.

- (10) Wait for the message on the screen to change from "Saving . . ." to "Completed".
- (11) Return the WRITE PROTECT tab on the target disk to its ON position.

7. SONG LOAD

This function allows you to “load” a song – that is, copy it from a floppy disk to the S-50’s memory.

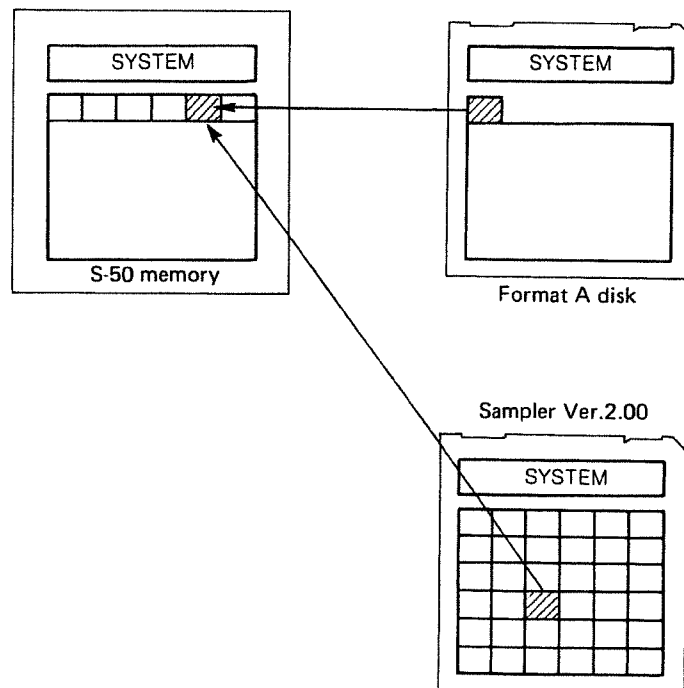

Figure 55 SONG LOAD

- (1) Press the DISK key to display the DISK COMMAND menu.
- (2) Use the UP and DOWN cursor keys to select the song area to hold the copy.
- (3) Insert the source disk into the drive.
- (4) (Format B disk only) Press the ENTER key to display the message

On disk, total * songs exist

(The software replaces the asterisk with the actual number of songs found).

Note: A song counts even when the display's [used] column lists its size as 0%. Although there may be no playback data, such a song always contains playback parameter settings.

- (5) (Format B disk only) Use the alpha dial or UP and DOWN cursor keys to select the song number and the number keys (1–6) to select the song bank.
- (6) Press the ENTER key to start the copy operation.

Note: The message No song appears if the software cannot find any data to copy.

- (7) Wait for the message on the screen to change from “Loading . . .” to “Completed”.

8. SOUND SAVE

This function allows you to copy the S-50's sound data to a sequencer Format A disk or a System Ver. 2.00 disk.

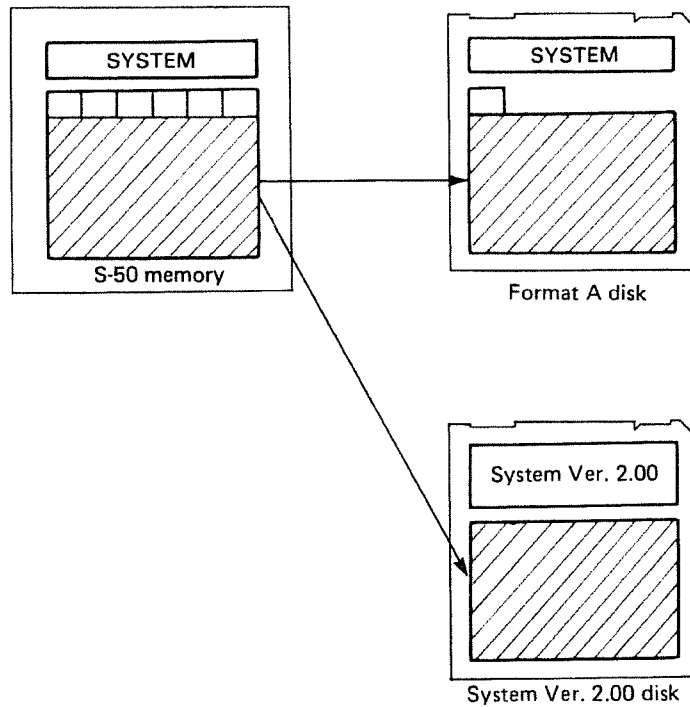

Figure 56 SOUND SAVE

- (1) Press the **DISK** key to display the **DISK COMMAND** menu.
- (2) Press the **+PAGE** and **P2** keys to select the **SOUND SAVE** function.
- (3) Shift the **WRITE PROTECT** tab on the target disk to its **OFF** position.
- (4) Insert the disk into the drive.
- (5) Press the **ENTER** key to start the copy operation.

Note: If you insert a Format B disk, the operation aborts with the message **Not Disk A.**

- (6) Wait for the message on the screen to change from **"Saving . . ."** to **"Completed"**.

9. SOUND LOAD

This function allows you to copy sound data from a sequencer Format A disk or a System Ver 2.00 disk to the S-50's memory.

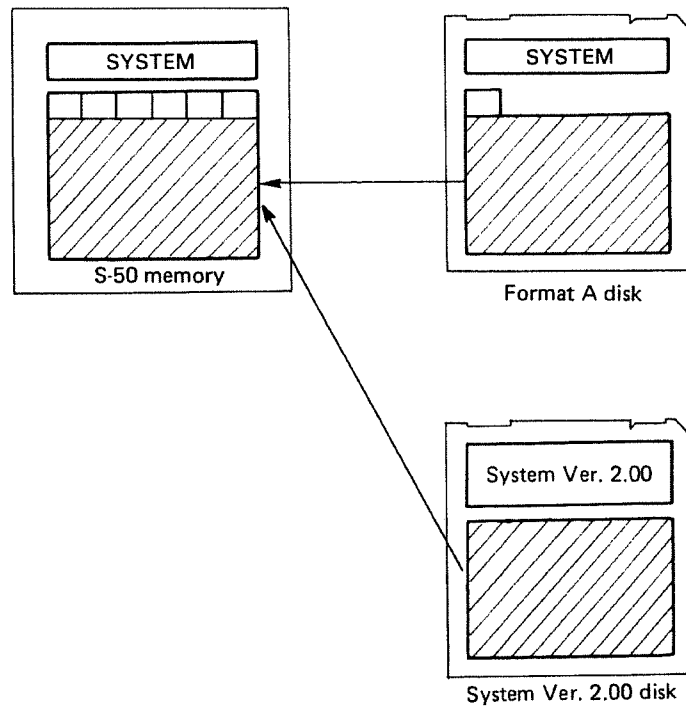

Figure 57 SOUND LOAD

- (1) Press the DISK key to display the DISK COMMAND menu.
- (2) Press the P2 key to select the SOUND LOAD function.
- (3) Insert the source disk into the drive.
- (4) Press the ENTER key to start the copy operation.

Note: If you insert a Format B or Ver. 1.00 disk, the operation aborts with the message **Not Disk A** or **Ver. error**. In the latter case, use the Ver. 2.00 CONVERT function to upgrade the disk to Ver 2.00. (Refer to p. 113 in your S-50 Version 2.00 Owner's Manual.)

- (5) Wait for the message on the screen to change from "Loading . . ." to "Completed".

10. SONG & SOUND

This function allows you to simultaneously copy both the song and sound data from a sequencer Format A disk to the S-50's memory.

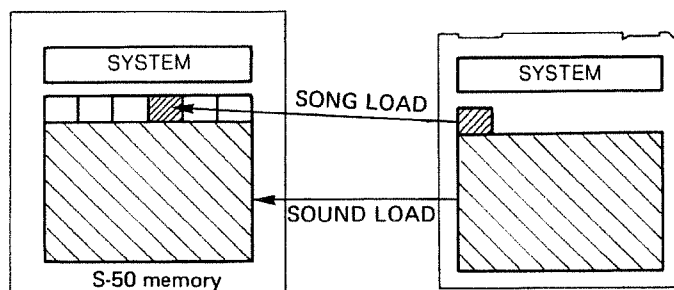

Figure 58 SONG & SOUND

- (1) Press the DISK key to display the DISK COMMAND menu.
- (2) Press the P3 key to select the SONG & SOUND function.
- (3) Use the UP and DOWN cursor keys to select the song area to hold the song.
- (4) Insert the source disk into the drive.
- (5) Press the ENTER key to start the copy operation.

Note: If you insert a Format B disk, the operation aborts with the message Not Disk A.

- (6) Wait for the message on the screen to change from "Loading . . ." to "Completed".

Note: The software automatically switches to the SONG PLAY screen and positions the cursor on the new song, so that you can start it with the PLAY key.

11. BANK SAVE

This function copies the six songs in the S-50's memory to a Format B disk.

Note: This function requires that you connect your Owner's key to the EXT CONTROLLER connector at the rear of the S-50.

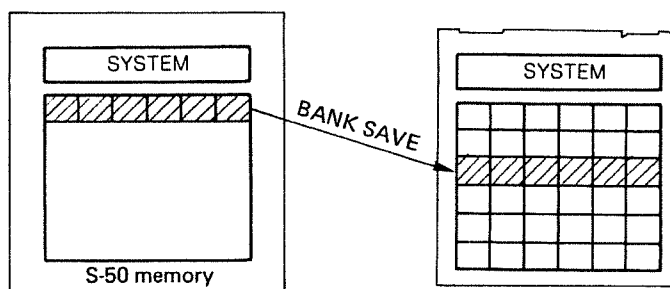

Figure 59 BANK SAVE

- (1) Plug your Owner's key into the EXT CONTROLLER connector at the rear of the S-50.
- (2) Press the DISK key to display the DISK COMMAND menu.
- (3) Press the +PAGE and P4 keys to select the BANK SAVE function.
- (4) Shift the WRITE PROTECT tab on a Format B disk to its OFF position.
- (5) Insert the target disk into the drive.
- (6) Press the ENTER key to display the message

On disk, total * songs exist

(The software replaces the asterisk with the actual number of songs found).

Note: A song counts even when the display's [used] column lists its size as 0%. Although there may be no playback data, such a song always contains playback parameter settings.

- (7) Use the number keys (1–6) to select the bank.
- (8) Press the ENTER key to start the copy operation.

Note: If you insert a Format B disk, the operation aborts with the message **Not Disk B.**
- (9) If the prompt "Overwrite OK?" appears, press either the ENTER key to proceed or the eject button on the drive to cancel.

Note: This prompt appears only if the target area of the disk already contains data.
- (10) Wait for the message on the screen to change from "Saving . . ." to "Completed" and the display to return to the SONG PLAY screen.

Note: This function saves the songs in the order that they appear on the SONG PLAY screen.

Note: This function saves a song even if it does not contain any playback data. Although the [used] column lists the size as 0%, the song still contains important playback parameter settings.
- (11) Return the WRITE PROTECT tab on the target disk to its ON position.

12. BANK LOAD

This function copies a bank of six songs from a Format B disk to the S-50's memory.

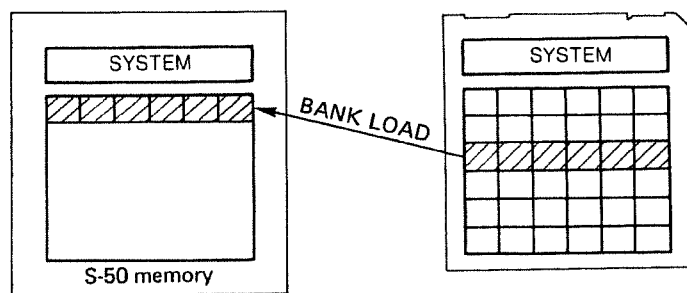

Figure 60 BANK LOAD

- (1) Press the DISK key to display the DISK COMMAND menu.
- (2) Press the P4 key to select the BANK LOAD function.
- (3) Insert a Format B disk into the drive.
- (4) Press the ENTER key to display the message

On disk, total * songs exist

(The software replaces the asterisk with the actual number of songs found).

Note: A song counts even when the display's [used] column lists its size as 0%. Although there may be no playback data, such a song always contains playback parameter settings.

- (5) Use the number keys (1–6) to select the bank.
- (6) Press the ENTER key to start the copy operation.

Note: If you insert a Format A disk, the operation aborts with the message **Not Disk B.**

- (7) Wait for the message on the screen to change from "Loading . . ." to "Completed" and the display to return to the SONG PLAY screen.

Note: This function loads the songs in the order that they appear on the source disk.

13. SYSTEM SAVE

This function copies the DIRECTOR-S software from the S-50 memory to any floppy formatted for use with the S-50. If the disk is a Ver. 2.00 disk, the software also clears the target disk's song data area.

Note: This function requires that you connect your Owner's key to the EXT CONTROLLER connector at the rear of the S-50.

- (1) Plug your Owner's key into the EXT CONTROLLER connector at the rear of the S-50.
- (2) Press the DISK key to display the DISK COMMAND menu.
- (3) Press the +PAGE and P7 keys to select the SYSTEM SAVE function.
- (4) Shift the WRITE PROTECT tab on the target disk to its OFF position.
- (5) Insert the disk into the drive.
- (6) Press the ENTER key to start the copy operation.
- (7) Wait for the message on the screen to change from "Saving . . ." to "Completed".

14. CHANGE SYS

This function allows you to switch to the S-50 Ver. 2.00 sampler system without cutting the power. The main advantage is that the sound data remains in the memory, where you can edit it. The sample system provides a similar function for returning to the sequencer.

Note: The function does not, however, save the six songs in the S-50's memory. You must therefore save them to a floppy disk if you want to keep them.

- (1) Press the DISK key to display the DISK COMMAND menu.
- (2) Press the P8 key to select the CHANGE SYS function.

Note: At this point, a message appears warning you that you are about to lose your song data.

- (3) Insert a Ver. 2.00 system disk into the drive.
- (4) Press the ENTER key to start the operation.
- (5) Wait for the message on the screen to change from "Loading . . ." to "Completed" and the Ver. 2.00 PLAY screen to appear.

Note: You may now create and edit the sound data.

Ver. 2.00 CHANGE SYS

- (1) Press the AUX key to display the SONG PLAY screen.
- (2) Press the P8 key to select the CHANGE SYS function.
- (3) Insert a DIRECTOR-S system disk into the drive.
- (4) Press the SHIFT key to display the command window.
- (5) Press the ENTER key to start the operation.
- (6) Wait for the DIRECTOR-S system to load and the SONG PLAY screen to appear.
- (7) If necessary, reload song data from a floppy disk.

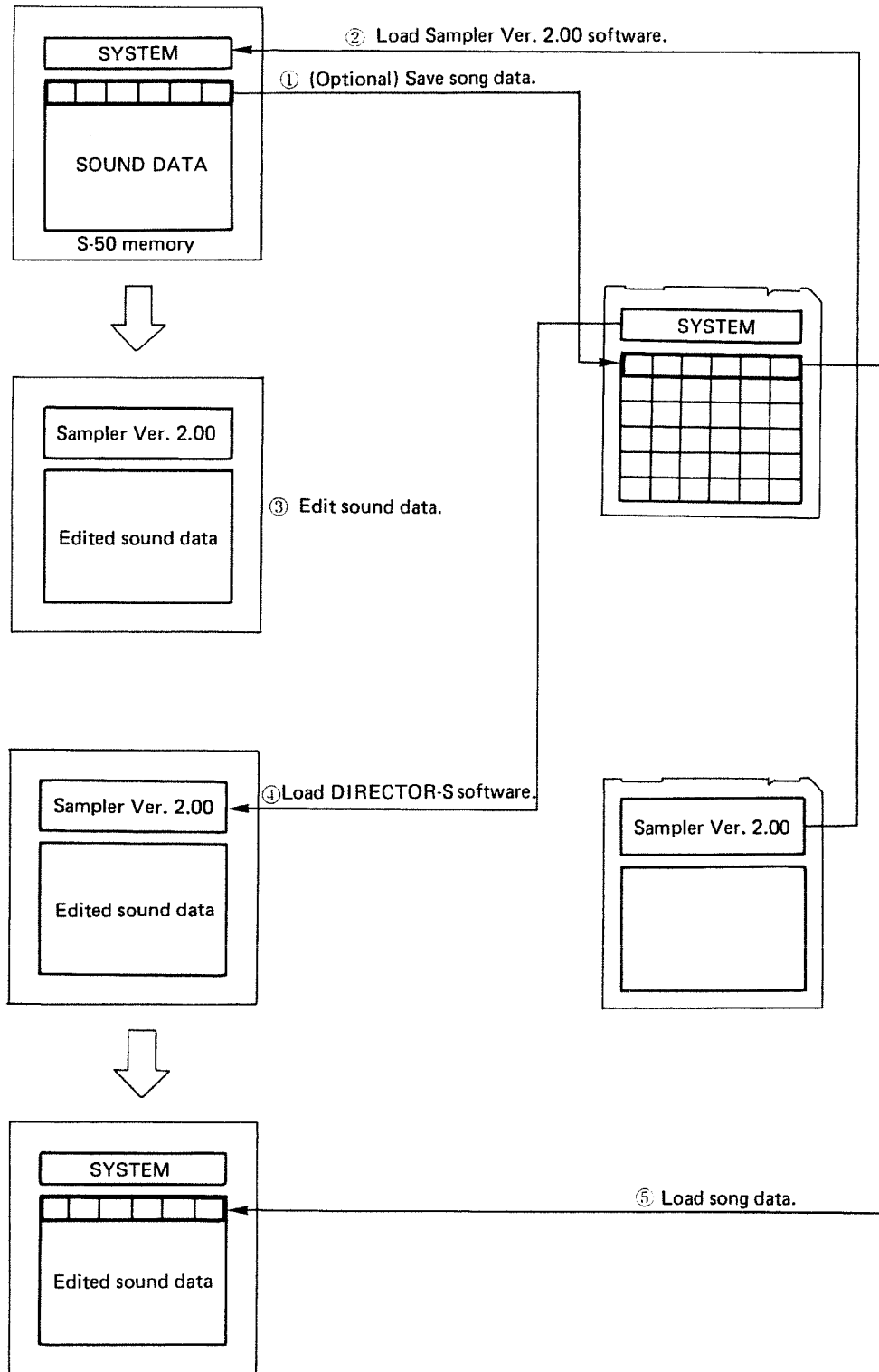

Figure 61 CHANGE SYS

7 OTHER FUNCTIONS

1. SONG CHANGE

When you boot the system, the S-50 memory contains only a single song (No. 1). This function allows you to change songs once you have created a new one or loaded more.

- (1) Press the **AUX** key to display the **SONG PLAY** screen.
- (2) Press the **SHIFT** key to display the submenu.
- (3) Use the alpha dial to shift the cursor to the desired song.

2. CHAIN PLAY

This function allows you to sequentially play the songs currently in the S-50's memory.

Note: This function plays the songs in numerical order and assumes that they been loaded and edit as necessary.

- (1) Press the **AUX** key to display the **SONG PLAY** screen.
- (2) Shift the cursor to "Chain . . ."
- (3) Use the alpha dial to select the type of chaining desired.

Pressing the **PLAY** key (Step 4 below) always starts the currently selected song. This setting determines what happens when the sequencer finishes playing this song.

OFF – No chaining. The song number does not change.

Loop – Stepwise chaining. The sequencer switches to the next song and waits for yo to press the **PLAY** key. The sequencer switches to song No. 1 after playing No. 6.

Loop-auto – Continuous chaining. The sequencer automatically plays the songs one after the other. The sequencer switches to song No. 1 after playing No. 6.

1 way-auto – The same as Loop-auto except that the sequencer plays each song only once and stops at No. 6.

- (4) Press the **PLAY** key to start the chain at the current song.

Note: If you wish to change the starting point, use the **SONG CHANGE** function: Press the **SHIFT** key, rotate the alpha dial, and press the **ENTER** key.

OFF

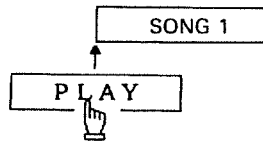

LOOP

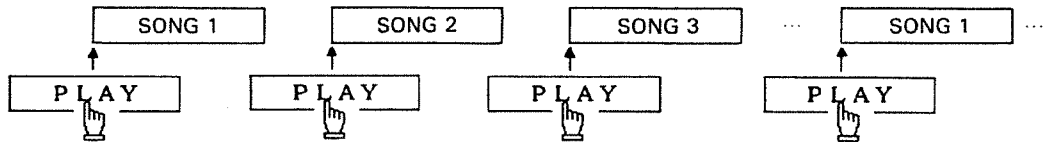

LOOP-auto

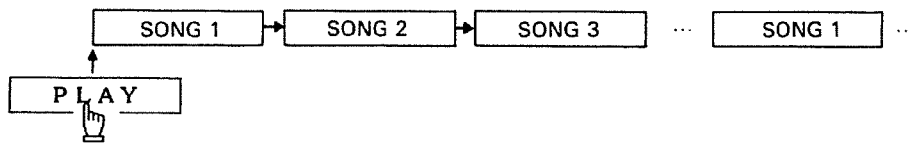

1way-auto

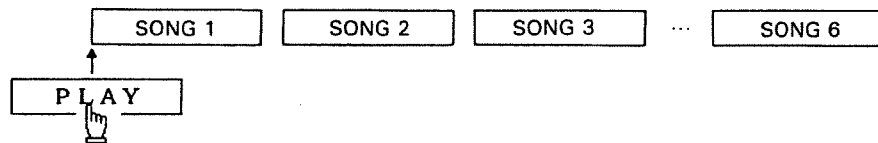

Figure 62 CHAIN PLAY

3. MIDI SYNC CLOCK

This function allows you to synchronize the sequencer with other MIDI equipment, making the sequencer either the master or the slave.

- (1) Press the MIDI and P1 keys to display the MIDI SWITCH screen.
- (2) Shift the cursor to SYNC CLOCK.
- (3) Rotate the alpha dial to switch between internal (INT) and external (EXT) timing signals.

Note: This setting determines whether the sequencer uses its own built-in clock (timing signal) or follows that of another MIDI instrument. (See below.)

3.1 INT – The S-50 as master

With this setting, the sequencer transmits a timing signal for the other MIDI instruments to follow.

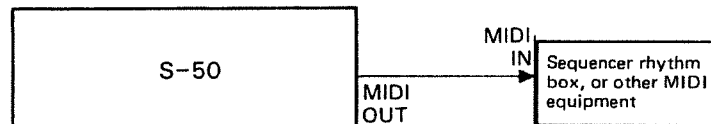

Figure 63 INT – The S-50 as Master

Note: This synchronizing signal does not stop, but the other instruments start and stop in unison with the sequencer whenever you press the PLAY key for the playback functions (in the SONG PLAY mode or PATTERN PLAY mode).

3.2 EXT – The S-50 as slave

With this setting, the sequencer adjusts its tempo to a signal from another MIDI instrument. It switches to its built-in clock, however, for the SONG PLAY and PATTERN WRITE modes.

Note: The word STOP appears on the message line of these two displays to signal that the sequencer is no longer responding to the external clock.

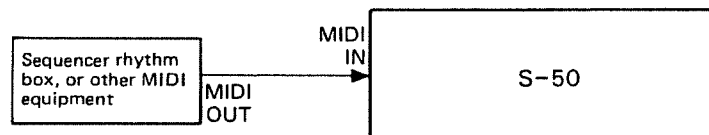

Figure 64 INT – The S-50 as Slave

The sequencer also starts and stops in time with the master instrument.

To record the data from the master instrument, press the EDIT (PATTERN WRITE) and REC keys so that the word REC flashes on the message line.

8 RECORDING MC-500 DATA

The DIRECTOR-S sequencer software stores a song as a list of patterns, so cannot directly record MIDI data from the MC-500. There is, however, a simple way around this restriction. The key to the procedure is to find repeating phrases in the MC-500 data and to record these as DIRECTOR-S patterns. (This approach also saves memory space.)



Figure 65 Connecting the S-50 and MC-500

Note: The S-50 time signature must match that of the MC-500 data. If the original changes tempo, use the MICROSCOPE display to insert a tempo change line at the appropriate spot.

1. Setting Up the MC-500

- (1) Make sure that the MC-500 is on STANDBY.
- (2) In order, press the MIDI, 1, 0, and ENTER keys.
- (3) Rotate the alpha dial to turn the TRANSMIT CLK switch ON.
- (4) Press the STOP key to return to STANDBY.
- (5) Press the RESET key to select the first bar.

2. Setting Up the DIRECTOR-S

- (1) Select a vacant song area or make one with the ALL CLEAR function. (See p. 36.)
- (2) Press the MIDI and P1 keys to display the MIDI SWITCH screen.
- (3) Use the cursor keys and alpha dial to turn the SYNC CLOCK switch to EXT and the RECEIVE switch to ON.
- (4) Use the same procedure to set the recording switches. (See p. 38)
- (5) Press the EDIT key to display the PATTERN WRITE screen.
- (6) Use the cursor keys and alpha dial to turn the GATE switch to REAL and the QUANTIZE switch to OFF.
- (7) Use the same procedure to set the SIZE parameter to one or two bars longer than you need.

Note: Although longer patterns are easier to work with, remember that the limit is 200 steps per pattern and that space requirements depend on data density. Making the size too small can produce such problems as (1) notes that sound but do not turn off because the requisite key off message is in the next pattern and (2) overwriting of data at the beginning of the pattern with excess data sent by the MC-500.

3. Recording the First Pattern

- (1) Press the S-50 REC key.

Note: The word **REC** flashes on the S-50 message line.

- (2) Press the MC-500 PLAY key to start both units.

Note: On the S-50, the word **REC** now stays alight.

- (3) Press the MC-500 STOP key in the bar following the last one in the pattern.

Note: The MC-500 plays the rest of the bar and then stops. The S-50 stops at the same time, and the word **REC** changes to **STOP**.

- (4) Reduce the pattern size on the S-50 to eliminate the extra bar.

Note: At this point, you may wish to play back the S-50 pattern to check.

4. Preparing for the Next Pattern

- (1) On the S-50, select the pattern number and set the size to one or two bars longer than necessary.

- (2) On the MC-500, press the “←”, “→” keys to start the word **MEAS** flashing and use the alpha dial or ten-key pad (with **ENTER**) to back up to the starting bar.

- (3) Use the procedure in the preceding section to record the pattern.

Note: The number in the upper right-hand corner of the S-50 screen tells you how much song memory space is available.

5. Storing the song

- (1) Press the **FUNC** to join patterns.

- (2) Join patterns together to form song. (See p. 49.)

- (3) Press **P5** keys to activate the **SONG NAME** function.

- (4) Give the new song a name. (See p. 52.)

SPECIFICATIONS

Name	DIRECTOR-S
Description	Software to turn the Roland S-50 Digital Sampling Keyboard into a MIDI sequencer with 16 sampled sound sources
Storage medium	3.5-inch floppy disks
Sequence organization	
Pattern	Real-time recording with optional QUANTIZE and GATE adjustment
Song	Linked patterns
Pattern editing	
Pattern copy	
Editing by channel/tone	Clear/delete/transpose
	Change velocity/MIDI channel
MICROSCOPE display	Change CPT/event
	Delete/insert event
Song memory	
Steps	2500
Patterns	200 (max. 200 steps each)
Resolution	96 steps/quarter note
Other data	
Song name	44 characters
Keyboard channel	
Keyboard octave	
Modulation depth	
Aftertouch sensitivity	
Control knob assignment	
MIDI switches	
Recording switches	
Metronome specifications	
Internal memory	
DIRECTOR-S software	
Songs	6 (max. 400 bars, 2500 steps each)
Sound data	1 set
Format A disk	
DIRECTOR-S software	
Songs	1
Sound data	1 set
Format B disk	
DIRECTOR-S software	
Songs	36
Synchronization	
MIDI SYNC CLOCK	
Song position pointer	

ERROR MESSAGES

1. Booting

D I S K L O A D E R R O R * *

Error code

The software area of the disk is damaged. Use another disk.

Note: Since disks wear out, it is essential that you use the originals only to make working copies for regular use and store them in a safe place.

L o a d i n g . . . * *

Error code

The song or sound data area of the disk is damaged if the number turns red during countdown. After this warning, the software clears the corresponding part of the memory and proceeds to the SONG PLAY display.

2. Loading

I n s e r t d i s k

There is no disk in the drive. Insert one.

D i s k e r r o r

The data area of the disk is damaged. Try another data area or another disk.

I n s e r t S - 5 0 d i s k

The disk in the drive has not been formatted for use on the S-50, so the software cannot load/save the requested data. Change disks.

D a t a e r r o r

The disk contains data which is not compatible with the song data format. After displaying this message, the software clears the corresponding part of the memory.

V e r . e r r o r

The drive contains a System Ver. 1.00 disk. If you wish to read from or write to the disk's data area, use the CONVERT function to upgrade the disk to Ver 2.00. (Refer to p. 113 in your S-50 Version 2.00 Owner's Manual.)

N o t S o n g d i s k

Although the disk is properly formatted, it does not contain song data.

N o t S o u n d d i s k

The drive contains a Format B disk, which has no sound data area. Change to a Format A or System Ver. 2.00 disk.

Not disk B

The drive contains a disk which is not Format B, the only format that supports BANK LOAD/SAVE operations. Change to a Format B disk.

No Song !

Although the disk is properly formatted, it does not contain song data.

No Data !!

The selected song is empty.

3. Saving

Insert disk

There is no disk in the drive. Insert one.

Protect !

The WRITE PROTECT tab on the disk is in its ON position. Remove the disk, shift the tab toward the edge, and reinsert.

Insert S-50 disk

The disk in the drive has not been formatted for use on the S-50, so the software cannot load/save the requested data. Change disks.

Ver. error

The drive contains a System Ver. 1.00 disk. If you wish to read from or write to the disk's data area, use the CONVERT function to upgrade the disk to Ver 2.00. (Refer to p. 113 in your S-50 Version 2.00 Owner's Manual.)

Not Song disk

The drive contains a sampler disk. Change to a Format A or Format B disk.

Not Sound disk

The drive contains a Format B disk, which has no sound data area. Change to a Format A or System Ver. 2.00 disk.

Not disk B

The drive contains a disk which is not Format B, the only format that supports BANK LOAD/SAVE operations. Change to a Format B disk.

INDEX

INDEX

A

All clear36

B

Backing up the System Disk11
Backup57
BANK LOAD65
BANK SAVE65
Bias48
Bootng9

C

Call a empty song36
CAF25
CAF sense45
Caring for your floppy disks5
CC25
Ch23
Chain play70
Change CPT26
Change event26
Change M. CH47
Change MIDI channel47
CHANGE VEL.48
Change Velocities48
CHANGE SYS68
Changing modes17
Changing a value17
Channel select32
Checking patch name22
Checking patch numbers and note data34
Checking tone names22
Clearing data36
Connections8
Control change38
Controller45
Creating song data13
Cursor control17
CPT23
CPT units24

D

Data error76
Delete50
Delete event28
Deleting data27, 31, 33, 47
Disk check58
DISK commands16, 53
Disk error76
DISK LOAD ERROR **76
Display tones22
Display channels22

E

Editing data46
Entering a value17
Erasing a Pattern37
Erasing a Song36
Erasing a channel data33
Erasing a tone data31
Error message76

F

Five DIRECTOR-S Modes16
Format A55
Format B56
Foot Pedal19

G

Gate41

I

Insert50
Insert disk76, 77
Insert event28
Insert S-50 disk76, 77
Inserting data28

Introduction 13

K

KB channel 18, 42
 KB octave 18, 43

L

Labels for the DIRECTOR-S MODE keys 4
 Load DIRECTOR-S software 70
 Load Sampler Ver. 2.00 software 68
 Loading and Saving Data 15
 Last step 40
 Loop 70
 Loop-auto 70

M

Meas 20, 23
 Measure 18
 Metronome 20, 39, 41
 Microscope 23
 MIDI & IMFO 16
 MIDI and Recording Switch 38
 MIDI RECEIVE switch 38
 MIDI TRANSMIT switch 38
 MIDI sync clock 72
 MOD depth 45
 Mode key 17
 Modifying data 26
 MULTI-PATCH PLAY 14
 MULTI-PATCH PLAY data 18

N

No Data! 77
 No Song! 77
 Not Disk B 77
 Not song disk 76, 77

Not sound disk 76, 77
 NOTE 25
 Note No. 23, 43

O

Owner's key 8, 11

P

PAf 25
 Patch 14, 22
 Patch name 22
 Pattern 20
 Pattern copy 47
 Pattern play 21
 Pattern Write 16, 20
 PB 25
 PG 25
 Playing a channel data 33
 Playing a tone 31
 Poly after touch 25
 Preparing to play 8
 Preparing to record 35
 Protect! 77

Q

Quantize 42

R

Receive 38
 Recording a pattern 44
 Recording MC-500 data 73
 Recording switch 38

INDEX

S

Scale select	40
Selecting a submenu	17
Set	49
Set clear	52
Size	20, 41
Slope	48
SONG & SOUND	64
Song	18, 20
Song CHANGE	70
Song Load	61
Song name	52
Song Play	16, 18
Song Save	59
Song Write	16, 49
Sound Load	63
Sound Save	62
Sound sources	14
Sound Sources and the Sequencer	13
Specifications	75
Specifying the sound source	37
Specifying the time scales	40
Split points	34
Standard Operations	17
Switch	38
Sync clock	73
System disk	9
System save	67
System software	9

T

Tempo	18, 20, 41
Tone	22, 30
Tone name	22
Tone numbers	20, 22, 30
Tone select	30
Transmit	38
Transpose	47
Two types of disk	54

V

Vel.	23
Ver. error	76, 77
Voice group	14

W

WRITE PROTECT tab	5
-------------------	---

1 way-auto	70
------------	----

MEMO

MEMO

DIRECTOR-S
Quick Reference

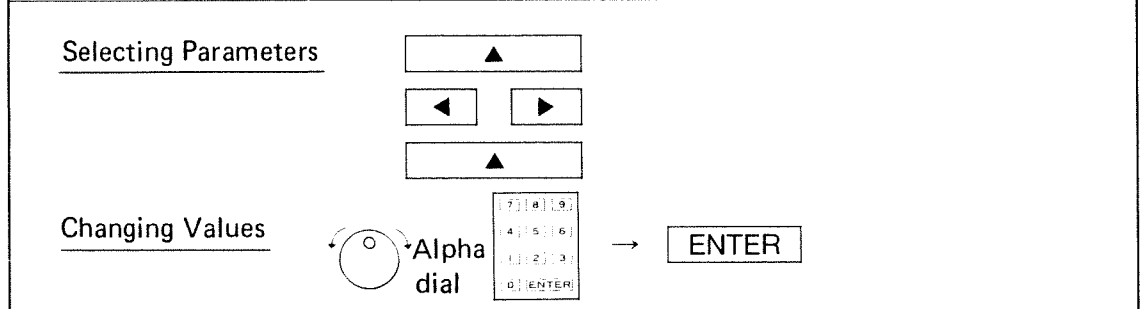
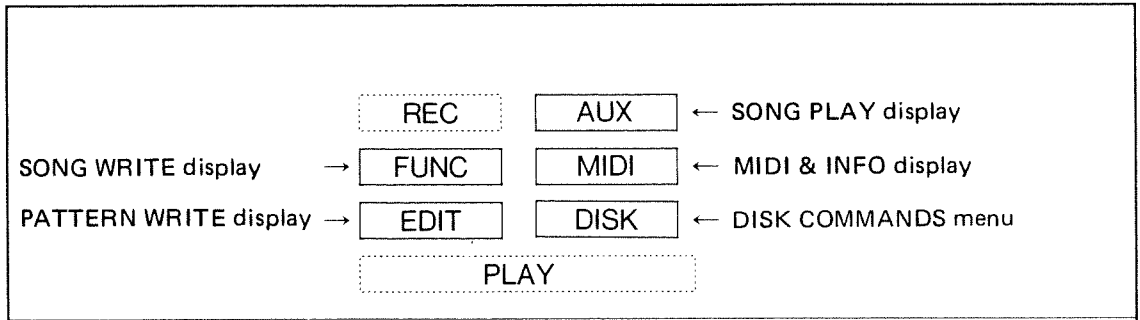

SONG PLAY display (AUX key)

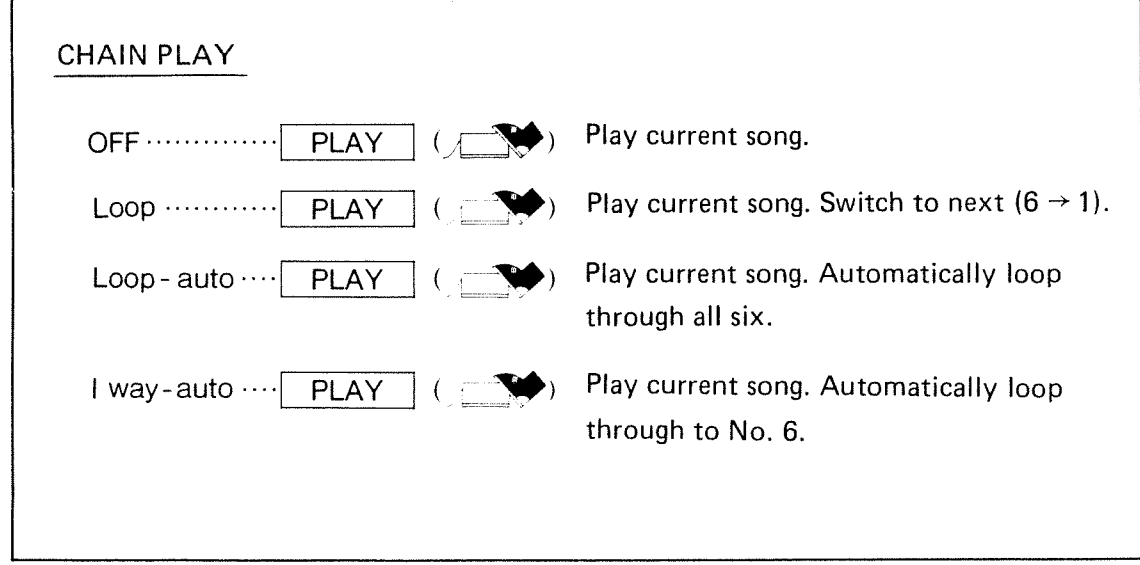
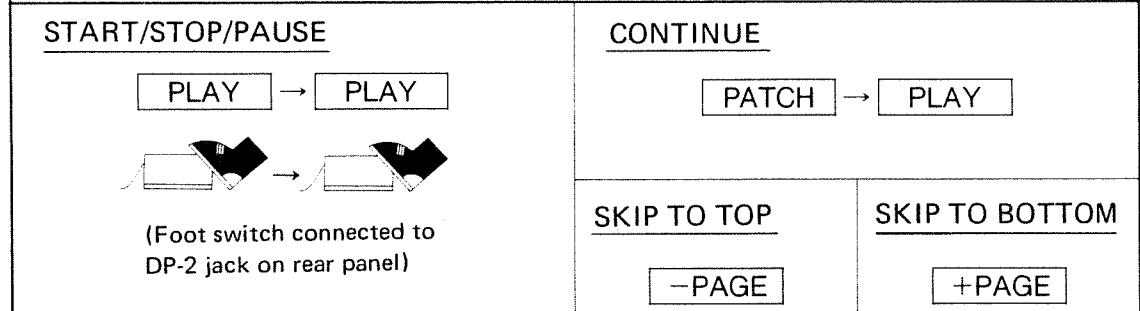

PATTERN WRITE display (EDIT key)

START/STOP

PLAY → PLAY

SCROLL BARS

-PAGE · +PAGE

Recording

REC =  (Foot switch connected to DP-2 jack on rear panel)

PLAY → REC → REC → REC → PLAY
PLAY PUNCH IN PUNCH OUT PUNCH IN STOP
(Play) (Recording) (Play) (Recording)

Changing programs (tones)

PATCH → P1 ~ P8
(Transmitted on keyboard channel)

Changing tone banks



PATCH → 1 Tones 11 – 18

PATCH → 2 Tones 21 – 28

PATCH → 3 Tones 31 – 38

PATCH → 4 Tones 41 – 48

Changing time scales

SHIFT — Scale Select → 
Last Step → 

→ ENTER

Changing channel display

PATCH → -PAGE Channels 1 – 8

PATCH → +PAGE Channels 9 – 16

Changing MIDI channel

SHIFT → Shift cursor to Change M. CH →

ENTER → Enter data → ENTER

(→ ENTER)

Use of PATCH keys (P1-P8)

P1 — P8

Play: Play back data.

Record: Delete data.

MICROSCOPE: Display data.

Editing PATTERN WRITE MICROSCOPE data (EDIT key)

Scrolling through data

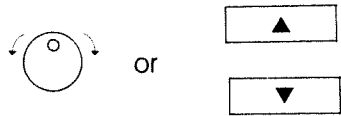

Switching between SEL and ALL

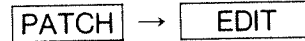

Changing display

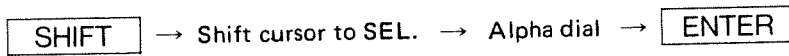

Changing Values

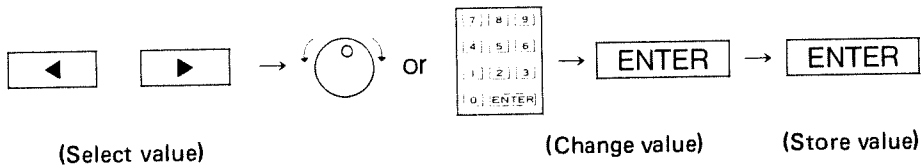

Deleting an event

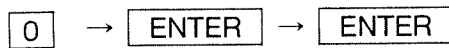

Adding an event

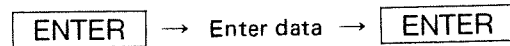

SONG WRITE display (FUNCTION key)

Menu:

<input type="button" value="P1"/>	Set :	Add pattern to song
<input type="button" value="P2"/>	Delete :	Delete pattern from song
<input type="button" value="P3"/>	Instant :	Insert pattern
<input type="button" value="P5"/>	Song Name :	Edit song name

Scrolling through data

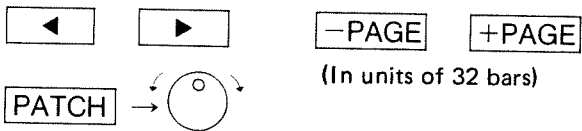

Adding a pattern

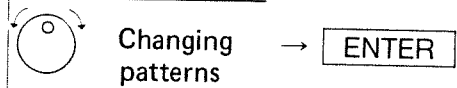

Deleting a pattern

Erasing pattern data

→ Track clear →

Erasing song data

→ All clear →

Inserting a pattern

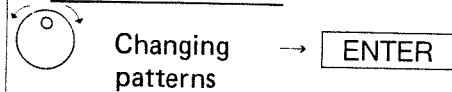

Editing song name

Changing characters



or

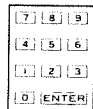

Changing case

Deleting characters

Inserting spaces

MIDI & INFO Display (MIDI key)

Switches

P1

Patch names

P5

Metronome settings

P2

Tone names

P6

DISK COMMANDS Menu (DISK key)

Load commands

-PAGE

Save commands

+PAGE

Song load

P1

Song Save

P1

Sound load

P2

Sound Save

P2

Song & Sound load

P3

Bank Save

P4

Bank load

P4

Format A

P5

Disk Check

P5

Format B

P6

Change System

P8

System Save

P7

Backup

P8

 Roland®

79481109

UPC 79481109



10991

SYS-503

 Roland

'87-8-D3-11