

SYNTHESIZER

SH-7

INSTRUCTIONS

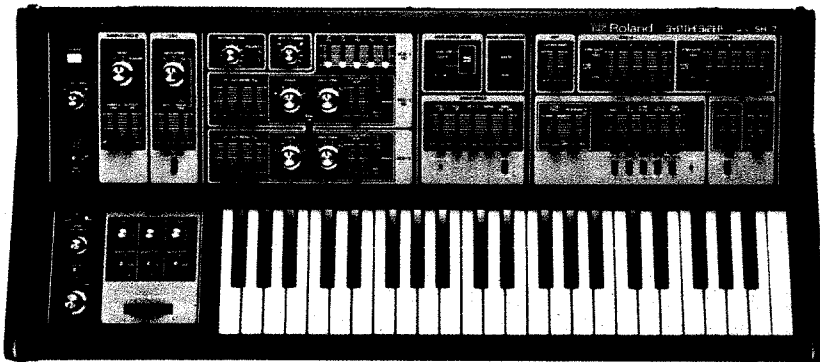

The Roland SH-7 Synthesizer employs newly developed VCO and VCF circuits. It incorporates two VCO's which enable you to perform two note intervals. The SH-7 uses the pitch standard of 1 volt/1 octave which is fast becoming an industry standard, particularly with studio type equipment. This means that the SH-7 is compatible with most types of studio equipment and with many stage type synthesizers.

The SH-7 provides inputs for external control voltage and gate for control of the synthesizer by means of an external keyboard controller, organ keyboard (such as the VK-9 or VK-6), guitar synthesizer, computer (such as the MC-8 MicroComposer). Control voltage and gate outputs are also provided so that the SH-7 can be used to control other synthesizers.

The SH-7 incorporates an envelope follower and a six mode multi-bender to give remarkable versatility to the SH-7.

It is possible to control pitch, tone color, and/or volume by means of the LFO for unique vibrato and tremolo effects. A great deal of planning went into the design of a logical panel layout to give the performer greater ease and freedom during performance.

PRECAUTIONS & METHOD OF SETTING

PRECAUTIONS

- Avoid using the synthesizer in very high or low temperature locations. Also keep it away from heaters and coolers since this type of equipment tends to affect circuit and pitch stability.
- Avoid using the synthesizer in very dusty or high-humidity places.
- If it is necessary to play the synthesizer in an area with neon or fluorescent lamps, keep the synthesizer as far away from these lamps as possible since they will induce high levels of noise. Sometimes, changing the angle of the synthesizer in relation to the lamps will help reduce noise.
- When connecting the synthesizer, plug the cord into the external amplifier first, then the other end into the SH-7 output. To disconnect, remove the cord from the synthesizer first, then from the amplifier.
- To clean the synthesizer, wipe with a cloth dampened with a neutral cleanser. Do not use solvents such as paint thinner.

BASIC SETTINGS

• COMBINING WITH ELECTRONIC ORGAN

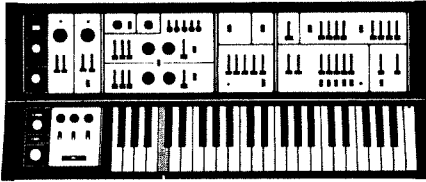

* Tune to unison with middle C on the organ.

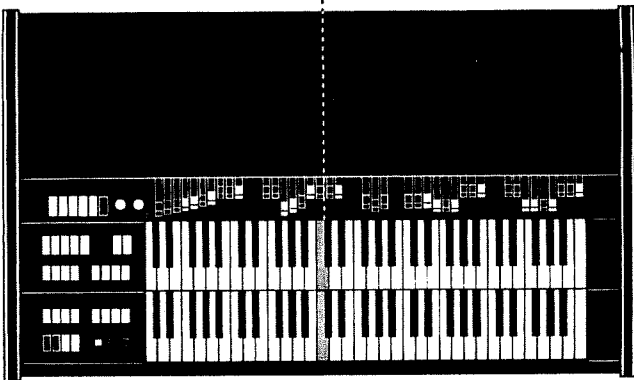

When playing an electronic organ in combination with the SH-7, set the units as illustrated above.

• CONNECTING TO AMP

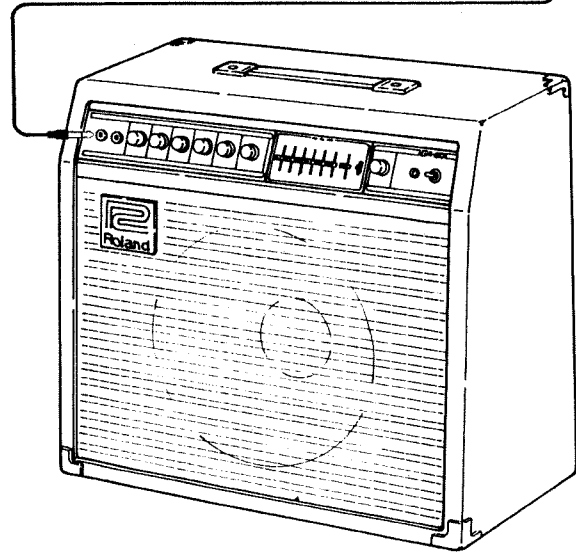
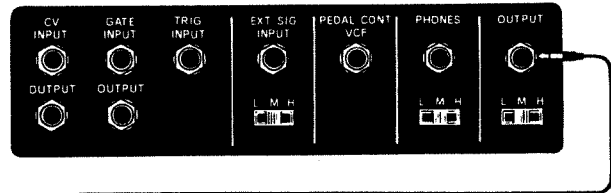

Connecting the SH-7 to an amplifier.

CONTROLS & BLOCK DIAGRAM

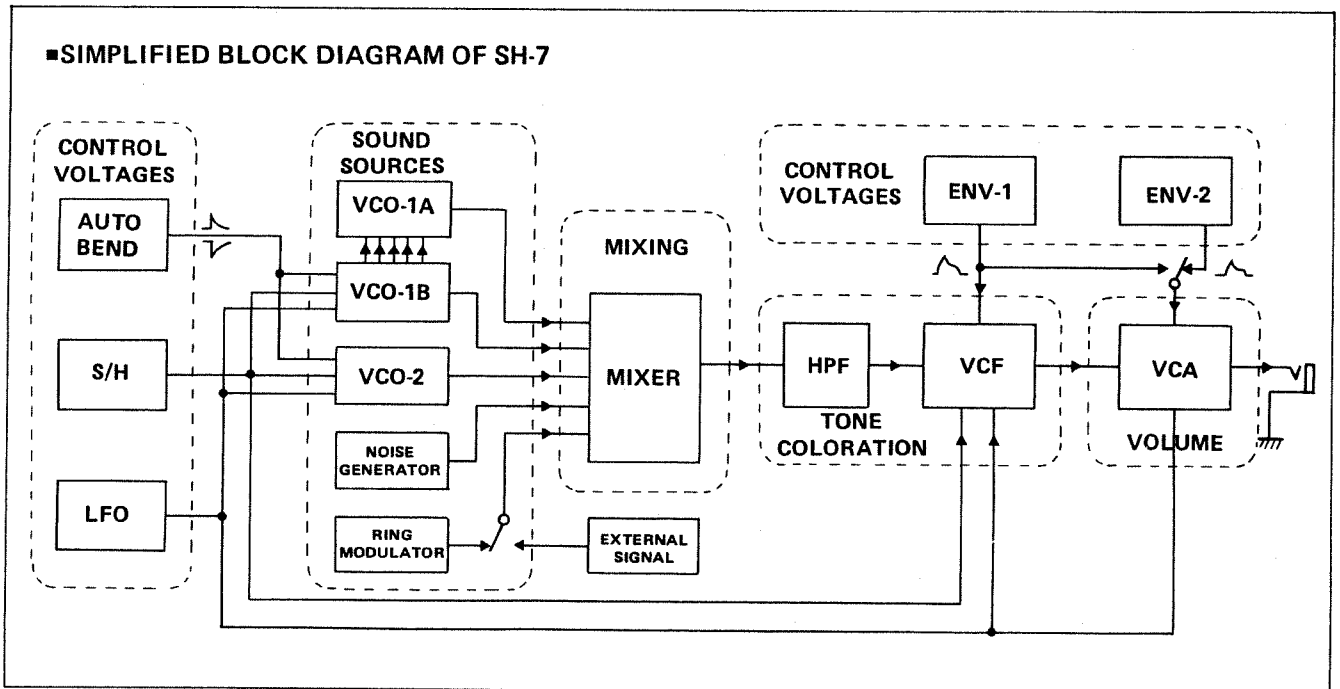
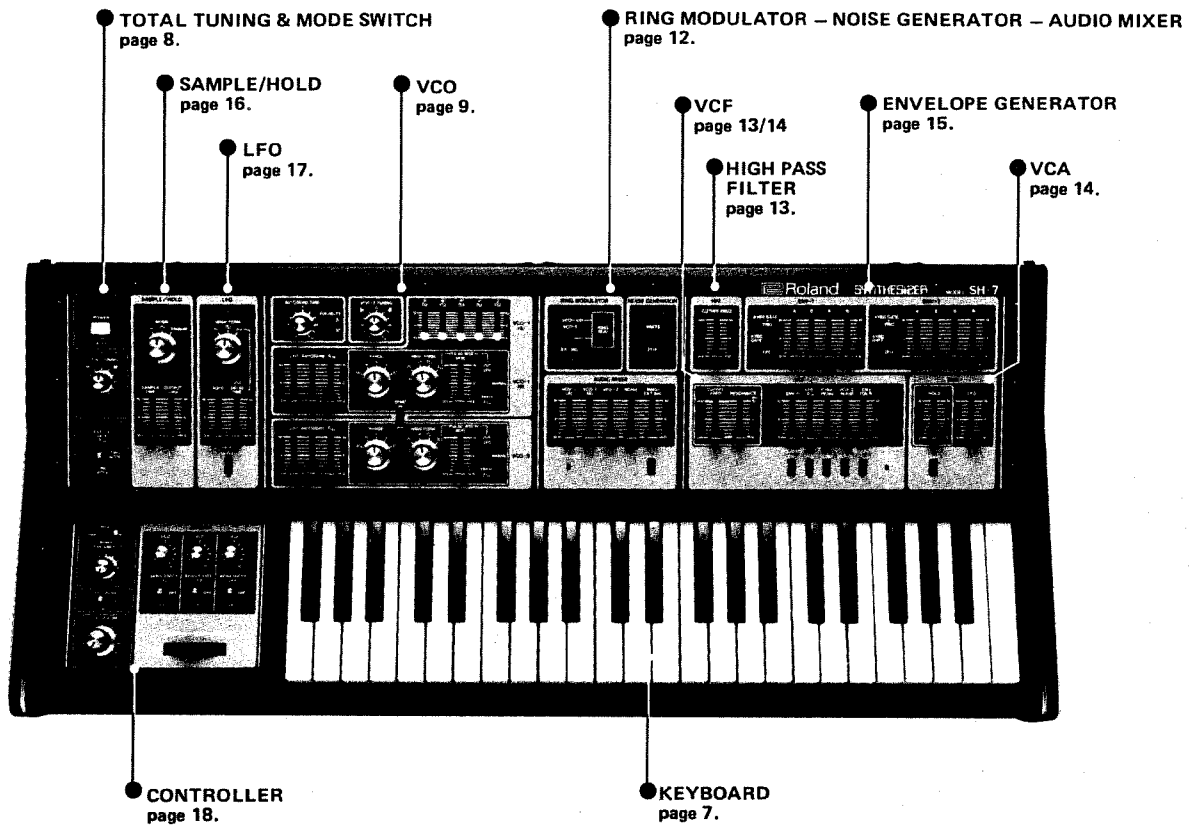

THE ABC OF SYNTHESIZER

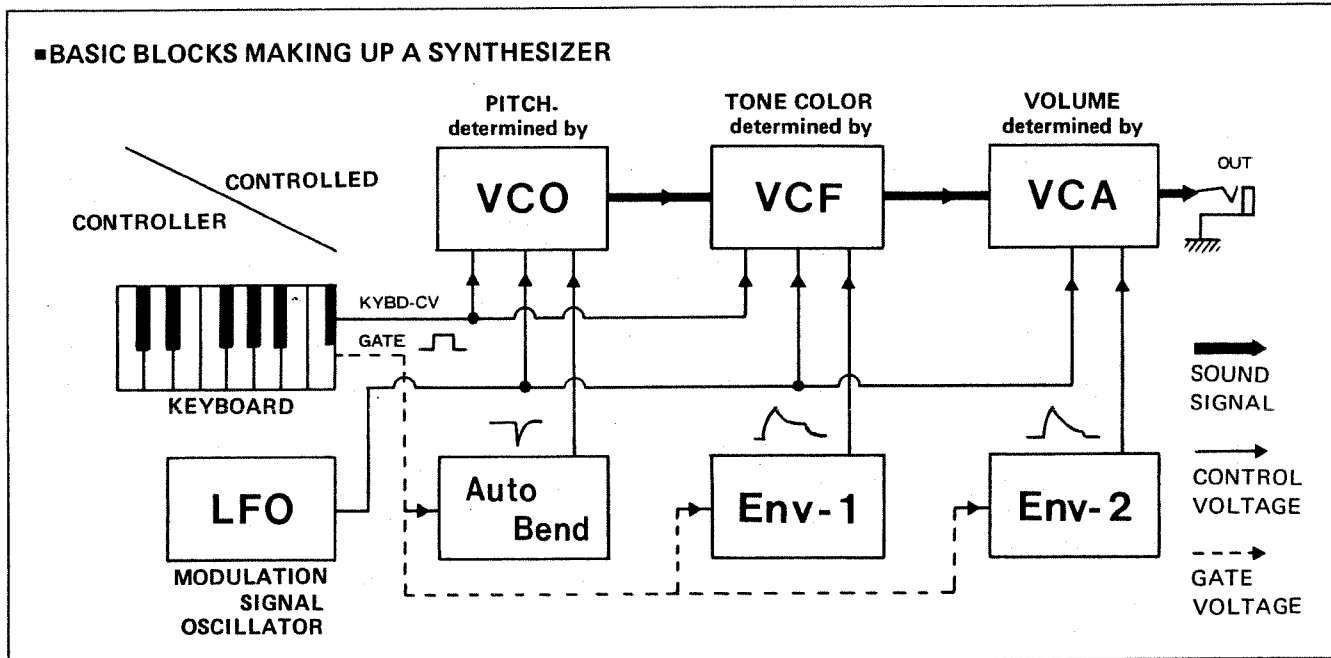

■ THE THREE QUALITIES OF SOUND

The three qualities of sound are: pitch, tone color, and loudness.

Sound is the result of physical vibration in objects. The pitch produced depends on the vibration rate. Fig. 1 shows that the higher the vibration rate, or the higher the frequency of the vibrations, the higher the pitch is. Frequency is measured in unit called the Hertz (Hz). If a sound source vibrates at a rate of 100 vibrations per second, it is said to have a frequency of 100Hz. The normal human ear can hear sounds with frequencies from about 20Hz to about 16,000Hz.

In synthesizers, pitch is controlled by the VCO (Voltage Controlled Oscillator). An oscillator is an electronic circuit which generates a waveform, or in this case, sound. Voltage controlled means that a voltage is used to control the frequency (pitch, in this case) of the oscillator; the higher the voltage, the higher the frequency. This, then, is the first quality of sound: pitch.

Fig. 1 shows what are known as sine waves, the simplest mode of vibration. The sound of a sine wave is very clean and pure. Most sound sources vibrate at many frequencies at the same

time, however. The lowest of the vibrations, and usually the strongest, is the one which we hear as the musical pitch of the sound source. The presence of these other frequencies is what gives a sound source its second quality: tone color.

The frequencies produced by the complex vibrations of a sound source are called harmonics. Harmonics are usually multiples of the pitch frequency. For example, consider a sound source which vibrates so as to produce a pitch with a frequency of 200Hz. The first harmonic would be 200Hz ($1 \times 200 = 200$). The first harmonic is also called the fundamental because this is the frequency which gives the sound its musical pitch. The second harmonic would be 2×200 , or 400Hz. The third harmonic would be 3×200 , or 600Hz; the fourth harmonic 4×200 , or 800Hz, etc.

Fig. 2 shows a square wave. Square waves produce a tone color much like that of a clarinet. Square waves contain only the odd numbered harmonics, or in other words, those frequencies which are one, three, five, nine, etc. times the frequency of the fundamental, or pitch frequency. The even numbered harmonics are missing. Tone color, then, is determined by the harmonic

content of the sound; the more harmonics there are, the brighter the tone color. In the synthesizer, tone color is controlled by the VCF (Voltage Controlled Filter). The VCO produces a basic sound wave rich in harmonics. The VCF is used to remove (or filter out) some of these harmonics thus controlling the harmonic content of the finished sound. The amount of the harmonics removed is controllable by a control voltage.

The third quality of sound, loudness, is determined in a synthesizer by the level or amplitude of the waveform, as shown in Fig. 3, and is controlled by the VCA (Voltage Controlled Amplifier).

The loudness of a sound changes during its production. Strike a piano key and the sound jumps the maximum loudness. Hold the key down and the sound slowly dies away. This pattern of loudness in a sound is called its envelope. The output of the envelope generator is a control voltage. This control voltage is used to control the VCA, thus shaping the loudness pattern of the output sound of the synthesizer.

FIG. 1 — SOUND PITCH = FREQUENCY

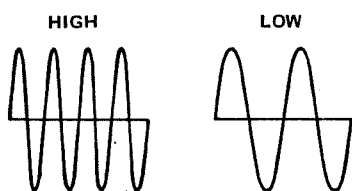

FIG. 2 — TONE COLOR = HARMONICS CONTENT

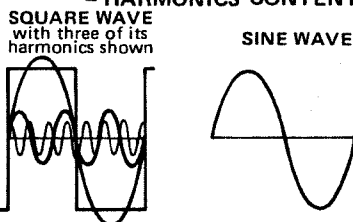
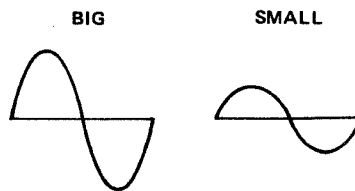
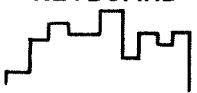



FIG. 3 — VOLUME = AMPLITUDE



CONTROLLED CONTROLLER	VCO PITCH = FREQUENCY	VCF TONE COLOR = HARMONIC CONTENT	VCA LOUDNESS = AMPLITUDE
KEYBOARD 	<p>The most common use of the keyboard control voltage is for the control of the pitch of a VCO; the pitch produced will correspond to the key pressed.</p>	<p>The tone color of most instruments will vary with pitch; higher pitches often produce brighter tone colors, lower pitches darker tone colors. For this purpose, the VCF can be controlled by the keyboard.</p>	<p>The control of loudness by means of the keyboard is of little practical use; the SH-7 has no provision for this type of control.</p>
ENVELOPE 	<p>With some sounds, it is desirable to incorporate pitch changes during the production of each note. The SH-7 contains a special envelope generator (autobend) provided exclusively for this purpose.</p>	<p>The tone color of many instruments, particularly the wind instruments, changes during the production of each note. This effect can be produced with envelope generator control of the VCF. Raising the VCF RESONANCE control will produce sounds possible only on the synthesizer.</p>	<p>The loudness pattern (or articulation) of a sound is produced by using the output of the envelope generator to control the VCA.</p>
LFO 	<p>The LFO (Low Frequency Oscillator) produces low frequency wave forms. Using the LFO sine wave output to control the pitch of the VCO will produce vibrato effects. The LFO square wave output will produce trills, and the sawtooth wave output will produce pitches which sweep downwards.</p>	<p>With some sounds, the tone color will vary at the same rate as vibrato. This can be done with LFO control of the VCF. Raising the VCF RESONANCE control will produce "growl" effects.</p>	<p>The LFO output can be used to vary the loudness of the sound output. The most common form is to use the sine wave output to produce tremolo effects.</p>

■BASIC SYNTHESIZER THEORY

In the synthesizer, then, the three qualities of sound are controlled by the VCO (pitch), VCF (tone color), and VCA (loudness). The tremendous versatility of the synthesizer is due to the principle of voltage control. The above table shows some of the possibilities.

The keyboard has two outputs: a control voltage and a gate pulse. The level of the control voltage will correspond to the last key pressed. The control voltage output is most often used to control the frequency of the VCO, thus, when a key is pressed, the VCO will produce the pitch which is related to that key. The keyboard produces a gate pulse each time a key is pressed. The gate pulse is most often used to trigger the envelope generator into operation. The control voltage output of the envelope generator, then, "opens" the VCA to let the sound wave out, thus the synthesizer produces sound each time a key is depressed.

The shape of the envelope is controlled by the envelope generator sliders. When the sliders are set, the envelope generator will generate a control voltage which corresponds to the shape of the desired envelope. When this control voltage controls the VCA, it regulates the loudness level

of the sound so that the loudness will rise and fall in the desired pattern. Fig. 4 shows the output sound wave when the envelope generator controls are set to produce a violin-like envelope, and Fig. 5 shows the output sound for a piano or guitar-like envelope.

The tone color of many types of sound will often change during the production of each note. This can be done with the synthesizer by using the output of the envelope generator to control the VCF.

There are two other sources of control voltage: the LFO (Low Frequency Oscillator) and the S/H (Sample and Hold), each of which can be used to control various synthesizer functions.

In the following pages, the functions of each of the synthesizer elements is explained in detail. When trying various sounds, try to analyze exactly what is happening; this will give you a better understanding of the synthesizer. Synthesizer sounds are very much enhanced by the use of effects units such as echo chambers, reverberators, chorus effects, phase shifters, flangers, etc, thus their use is highly recommended.

FIG. 4 - VIOLIN-LIKE SOUND

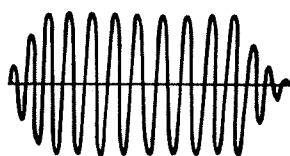

FIG. 5 - PIANO-LIKE SOUND

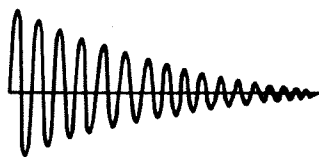
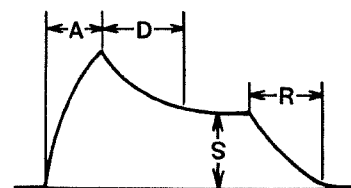
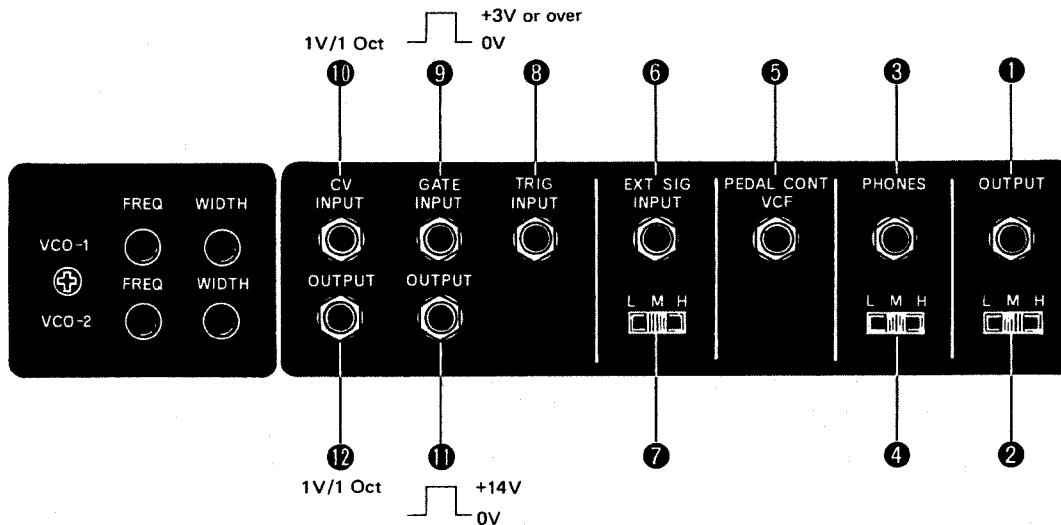

FIG. 6 - PARTS OF ENVELOPE



CONNECTION JACKS



CONNECTION JACKS

1. OUTPUT

Connect to guitar amplifier, mixer, or audio amplifier. If you use an effects unit like an echo chamber, connect it between the output jack and the amplifier. When using audio amplifiers such as those in home stereo systems, use caution with the volume control because the synthesizer is capable of generating sound levels high enough to destroy the speakers.

2. OUTPUT LEVEL

Set this switch to L, M, or H according to the input sensitivity of the amplifier used. Set to L or M for an ordinary guitar amplifier and to H for an audio amplifier or mixer.

3. PHONES JACK

Connect headphones to this jack. Use headphones designed for normal home stereo systems. Roland RH-1 headphones are suited for this purpose. The output level from this jack is constant, independent of the TOTAL VOLUME setting. Therefore, you can turn down the volume from the speaker when adjusting sounds with the headphones. This is very convenient for setting sounds on stage.

4. PHONES OUTPUT LEVEL

This switch changes the output level at the PHONES jack. Set it at the position to suit the sensitivity of the headphones you use.

5. PEDAL CONT VCF

A pedal like the FV-1 or FV-2 can be connected to this jack to control the Cutoff Frequency

of the VCF. The pedal functions as a wah wah pedal when the VCF RESONANCE control is raised.

CAUTION: Be sure to use the foot pedal's OUTPUT jack and not its INPUT jack. The OUTPUT jack is on the right side of the FV-1 and on the left side of the FV-2.

6. EXT SIG INPUT

Connect external sources such as a microphone, electric guitar, electric piano, or strings to this jack.

As the SH-7 incorporates an envelope follower, the VCF can be controlled by the level of the signal from the external source to use the SH-7 as a kind of effects unit like automatic wah. When connecting the strings such as the Roland RS-202, connect the gate output also to make it possible to control the envelope generator of the SH-7 from the strings keyboard. With this setting, the VCF can be activated on brass chords producing sounds like a polyphonic synthesizer.

7. EXT SIG INPUT LEVEL

This is a level changeover switch for the external input. Set to H for microphone, to M or H for an electric or electronic instrument. When connecting a tape recorder or other audio devices, set to L.

If the output level is low even when the EXT SIG control on the AUDIO MIXER is set to maximum, set the EXT SIG INPUT switch a step higher. If the sound is distorted by excessive input, change to a step lower.

8. TRIG INPUT

This jack receives external trigger pulses. When +15V pulse is fed to this jack, the SH-7 gate is triggered.

9. GATE INPUT

This jack receives gate pulses from sources such as the VK-6 or VK-9 Organ, the Model 104 (System 100) or Model 717A (System 700) Analog Sequencer, the MC-8 MicroComposer, the RS-202 String Synthesizer, etc.

10. CV INPUT

In the same way as the above Gate Input, control voltages from external sources can be connected to this jack.

When connecting external control voltages to control the SH-7, be sure to set the KEY MODE switch to EXT position. (See page 8).

11. GATE OUTPUT

The gate output from the SH-7 keyboard can be taken from this jack. Connect to the gate input of an external synthesizer or the MC-8 MicroComposer for control of such devices with the SH-7 keyboard.

12. CV OUTPUT

This jack outputs control voltage from the SH-7 keyboard. Connect to the CV input to an external synthesizer or the MC-8 MicroComposer to control such devices with the SH-7 keyboard.

CONNECTION METHODS

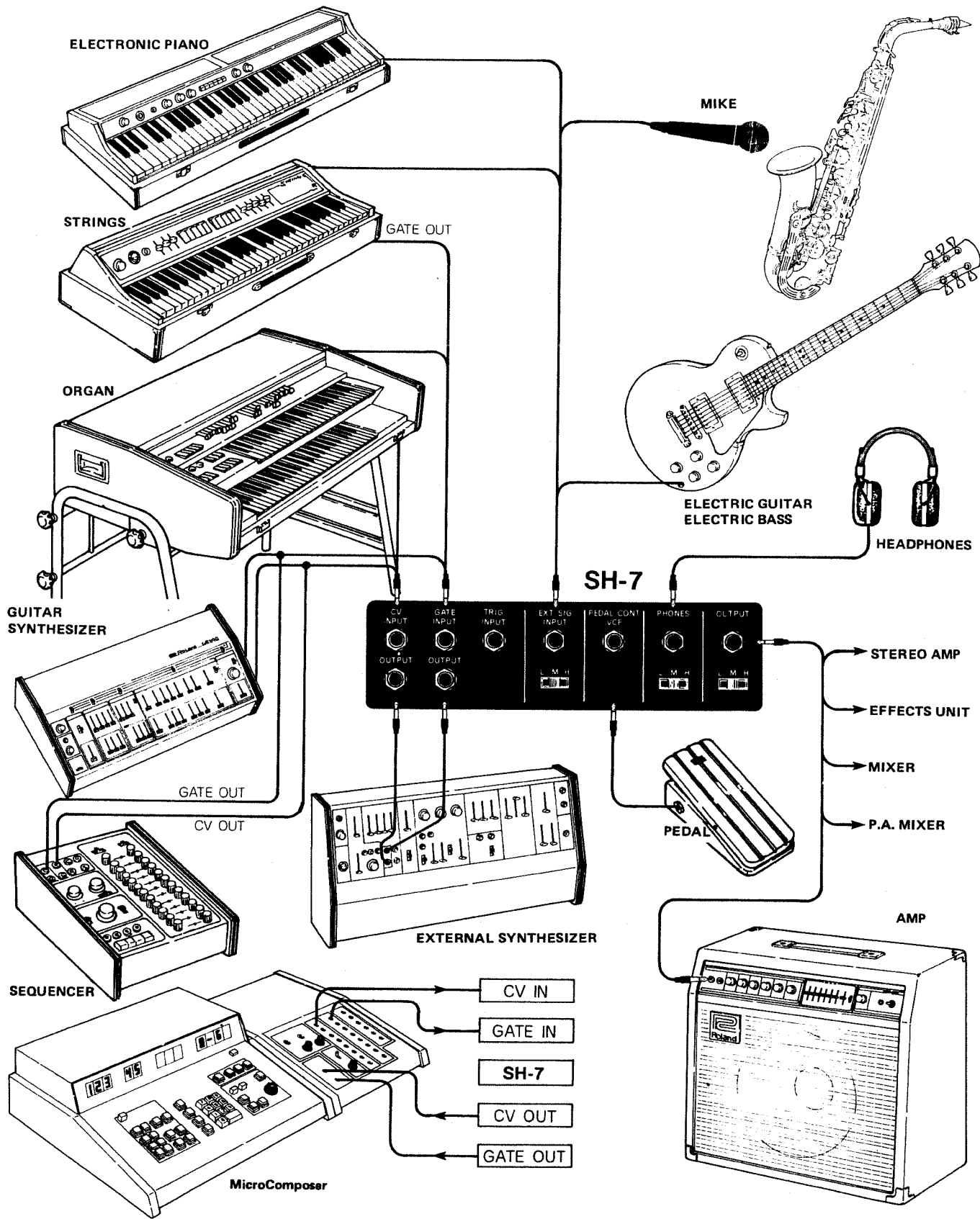

KEYBOARD

■KEYBOARD

The SH-7 keyboard has 44 keys for a range of 3-1/2 octaves, but by use of the VCO RANGE switch and the CONTROLLER section TRANSPOSE switch, the SH-7 has a total pitch range of over nine octaves which covers the full range of human hearing.

With the RANGE switches at 8' and the TRANSPOSE switch at M, the lowest C on the keyboard corresponds to middle C on the piano.

■KEYBOARD VOLTAGE

The keyboard produces a control voltage which corresponds to the key pressed. This control voltage is most often used to control a VCO so that it produces the pitch related to the key pressed.

The SH-7 uses the relation of 1 volt/1 octave (one volt per octave) which means that a one volt change in the control voltage will produce a one octave change in pitch. The relation is very common and is used on most synthesizers and related equipment, including professional studio equipment as well as stage type equipment. This means that the SH-7 is compatible with most equipment used in electronic music.

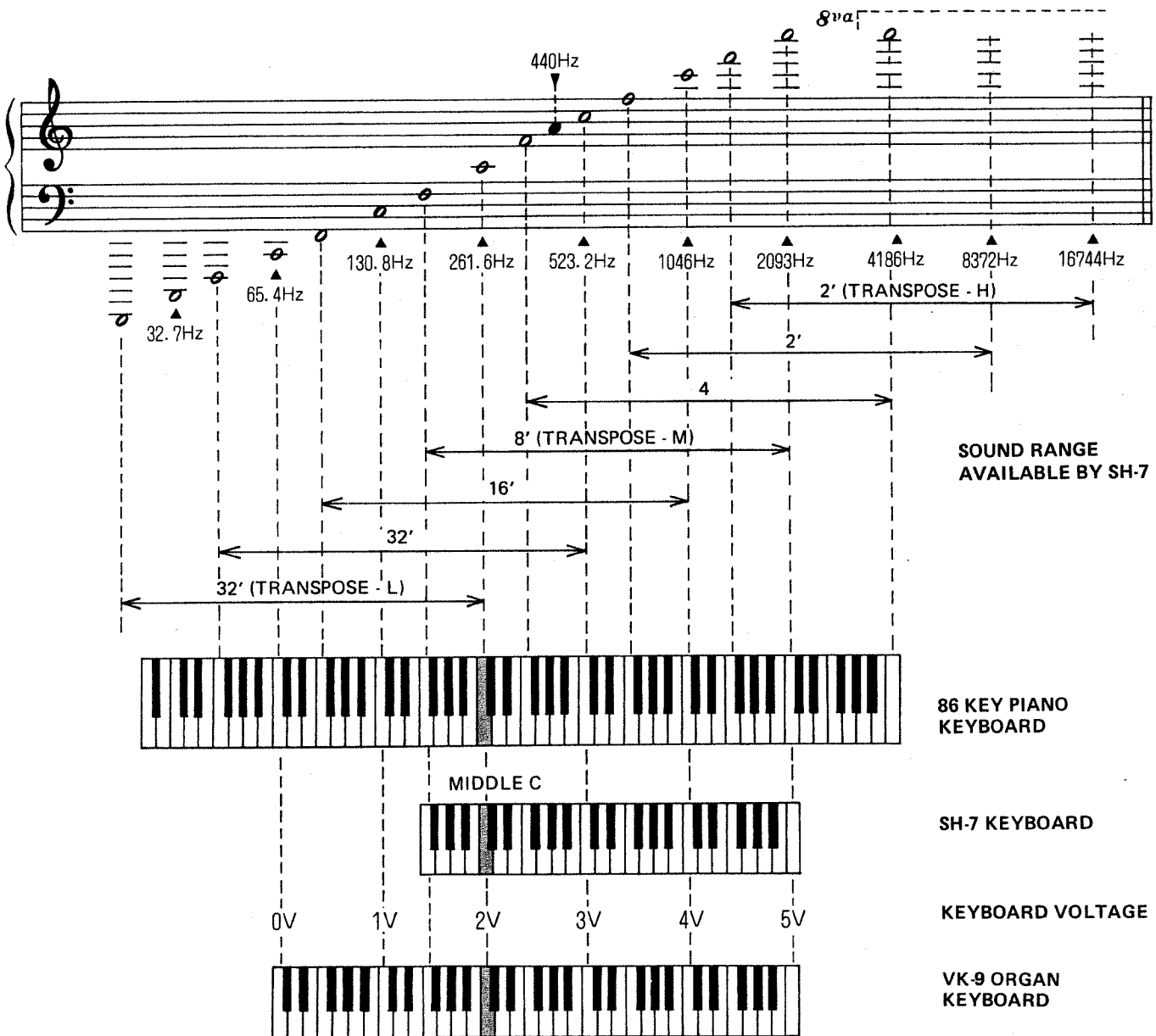

TOTAL TUNING & MODE SWITCH

1. POWER SWITCH

Push Power switch and the LED (light emitting diode) will light indicating the SH-7 is on.

NOTE: It requires about five minutes for the SH-7 circuits to completely stabilize. Keep this point in mind when using the SH-7 on stage or in recording sessions.

2. TOTAL TUNING

This controls the overall pitch of the SH-7. Both VCO-1(A), and (B), and VCO-2 are tuned simultaneously by this control.

The tunable range is ± 300 cents (300 cents = minor third), thus if C were the center pitch, the range would be from the A below to the E \flat above. With this feature, the SH-7 can play transposing parts such as for trumpet or saxophone without having to rewrite the parts or transpose mentally.

When first turning the SH-7 on, be sure to allow enough time for the circuits to stabilize before trying to tune accurately.

3. KEY MODE SWITCH

Set the switch at the TWO NOTE position for ordinary performance. Normal one-note and two-note performance is possible with this position. Set the switch at the ONE NOTE position to get excellent trills in one-note performances. At the ONE NOTE position, only one note is produced even when two keys are depressed simultaneously. If two keys are depressed simultaneously, only the higher note will sound because it has priority. Fairly fast trills are possible by keeping the lower key depressed and striking the higher key intermittently. For this trill performance, set the TRIGGER MODE switch of the Envelope Generator to the KYBD GATE + TRIG position (see page 15).

Set the KEY MODE switch to EXT CV/GATE/(S/H) when controlling the SH-7 with external signals from an organ, guitar, sequencer, computer, string synthesizer (RS-202), etc.

In performance, this switch is convenient because it allows instant changes of control of the SH-7 between by its own keyboard or from an external source.

When nothing is connected to the GATE and CV INPUT jacks, the EXT CV/GATE/(S/H) position of the KEY MODE switch will give control of the synthesizer to the S/H (Sample and Hold) for automatic performance. Since the S/H will repeatedly trigger the envelope generator, this position of the switch can also be used for rapidly repeating notes.

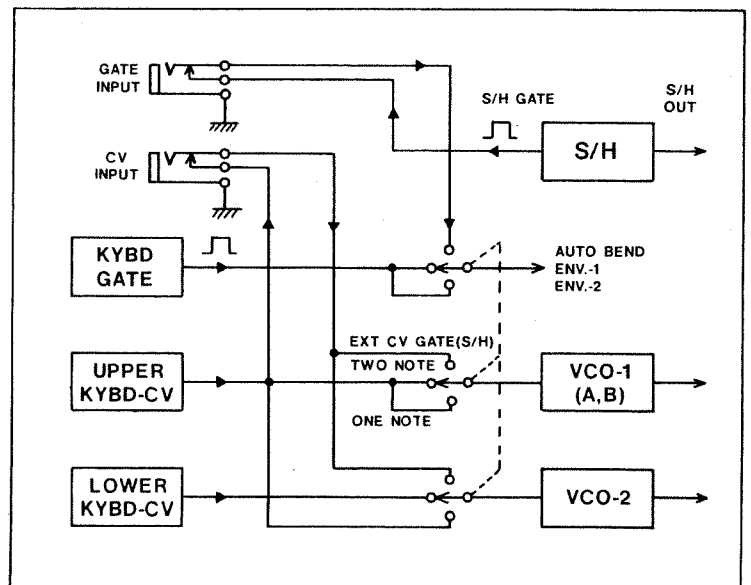
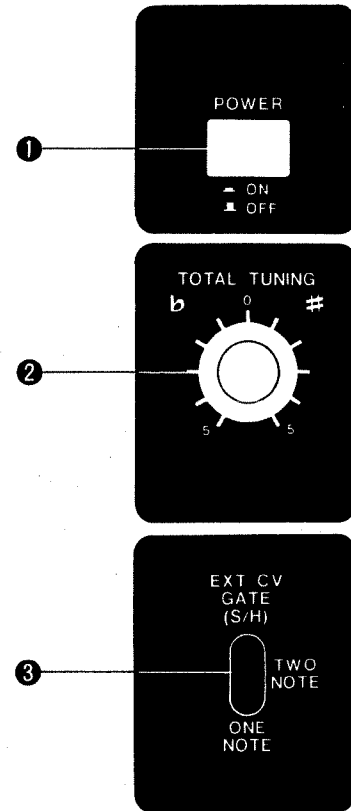

VCO — VOLTAGE CONTROLLED OSCILLATOR

The VCO is the primary sound source of the synthesizer and generates the basic waveforms. The frequency or pitch of these waveforms is controlled by a control voltage.

SH-7 incorporates two independent VCO's, VCO-1 and VCO-2. VCO-1 produces five different square waves of 2', 4', 8', 16', and 32'. This feet-series output is distinguished as VCO-1(A). VCO-1(B) is exactly the same as VCO-2. When a chord of two notes is played on the keyboard, VCO-1(A,B) produces the higher pitch and VCO-2 the lower.

■ VCO CONTROL VOLTAGE INPUTS

The most important control of VCO pitch is by means of the keyboard control voltage and the BENDER control voltage. The keyboard control voltage is internally connected to the VCO through the KEY MODE switch. The BENDER control voltage is connected through the BENDER SENSITIVITY controls.

Other sources of control voltage for control of the VCO are: the LFO, AUTOBEND voltage, and the S/H. Each of these may be fed to the VCO in the amounts needed to produce the desired effects. Since (A) and (B) represent two parts of the same VCO, they are both controlled by the same set of control voltage input sliders.

With two note performance, it is recommended that the input levels for one VCO be the same as the corresponding effect for the other VCO.

1. LFO

This slider determines the depth of control the LFO (Low Frequency Oscillator) will have on each VCO. It can be used for vibrato effects, and for large sweeping pitch changes.

2. AUTOBEND

This control adds a change of pitch at the beginning of each note played. By raising this control, the VCO pitch is controlled by a ∇ shape or a ∇ shape voltage envelope so that the sound starts with a lower or higher pitch. When the ∇ shaped bend is used, the human voice, whistling, and other sound sources which begin on lower pitches, will sound more real and natural. When the ∇ shaped bend is employed, chirping sounds of birds can be obtained.

3. S/H (SAMPLE & HOLD)

This is for controlling VCO pitch with the S/H output. When this control is raised, random notes of irregular pitches and staircase changes of pitch for arpeggio-like effects can be produced. With the SH-7, the envelope generator can be triggered with changes in the pitches produced by the S/H. Set the KEY MODE switch (see page 8) to EXT CV/GATE/(S/H) to trigger the envelope generator with the S/H clock pulses. For this mode of operation, there should be no connection to the GATE INPUT jack, otherwise the envelope generator will be triggered from the external source.

4. AUTOBEND TIME

This controls the time required for the VCO to return to its normal pitch when using the AUTOBEND. Turning the knob clockwise increases the time. Normally, this control is set between 0 and 5; special effects are obtained with higher settings.

5. POLARITY

This switch changes the autobend polarity.

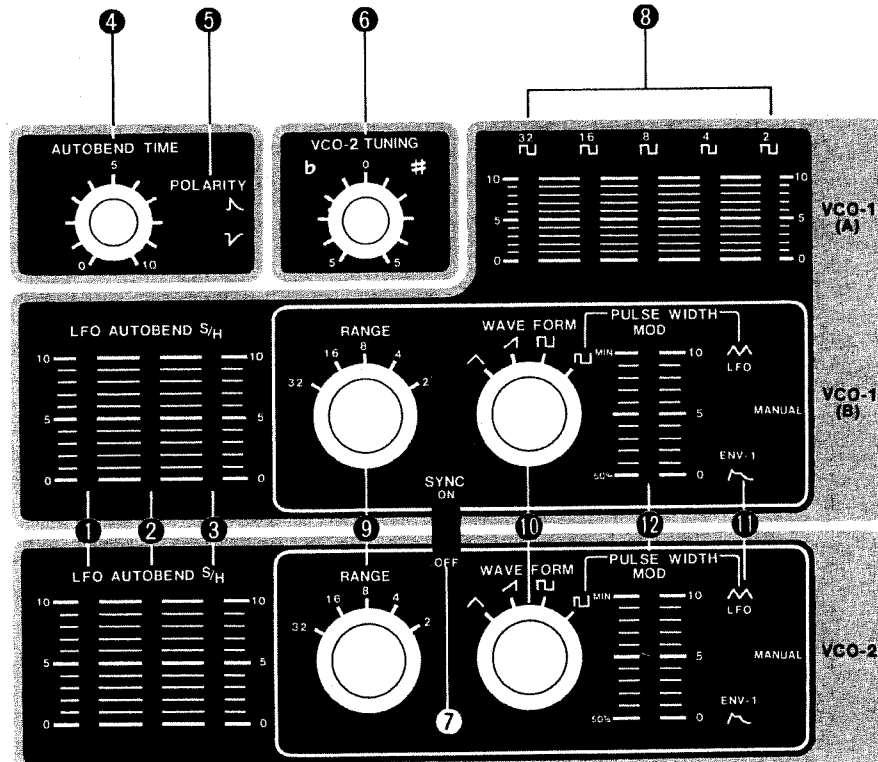

The sound will start with a higher pitch when set to the ∇ position and a lower pitch at the ∇ position. The ∇ shape bend is normally used. The ∇ shape bend is used for special effects like chirping of birds.

6. VCO-2 TUNING

This control is for the tuning of VCO-2 only and is used to match the pitches of VCO-2 to VCO-1; or for purposely mistuning, or to produce tunings of musical intervals. The range of this control is ± 700 cents (700 cents = perfect fifth), or, with C as the center, from the F below to the G above.

7. SYNC SWITCH

Turning this switch ON will lock the frequency of VCO-2 to that of VCO-1 so as to completely eliminate beat frequencies caused by slight mistuning. Besides unison, the VCO frequencies will lock at various octave intervals also. Since other intervals become impossible, the two voice feature of the keyboard is no longer operable.

8. VCO-1(A) FEET SERIES MIXER

The (A) portion of VCO-1 simultaneously produces five square waves which can be mixed together in any desired ratio. As shown in the drawing on the right, when the synthesizer is set to produce the pitch of middle C, the square waves produce pitches one and two octaves above and below middle C.

Interesting sounds can be produced by mixing the 2' output with the 8' output, or the 2' output with the 16' output. The 2' + 8' combination produces a vibraphone-like sound. Using all of the outputs together produces very large full sounds.

Raising and lowering these controls has no effect on the total sound level at the output of the synthesizer; the sound level will remain the same whether one or all the controls are raised.

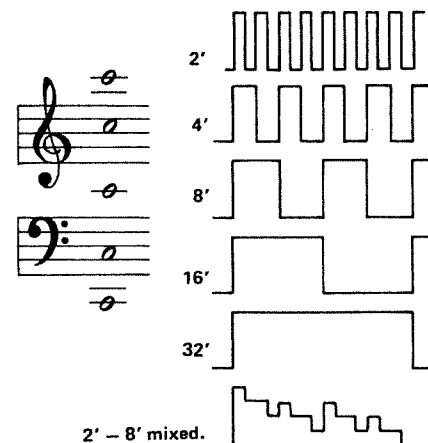

9. RANGE SWITCH

This switch changes VCO range in one octave jumps from 2' to 32', for a total range of five octaves. The 8' position of the RANGE switch is used for sound in the middle sound range; the lowest C on the keyboard will produce the pitch of middle C. The 4' position produces pitches in the range one octave above 8', and the 2' position produces pitches two octaves above 8'. The 16' and 32' positions produce pitches one and two octaves below 8' respectively.

4'	WHISTLE PICCOLO GLOCKENSPIEL
8'	FLUTE OBOE VIOLIN TRUMPET HARMONICA
16'	CLARINET SAXOPHONE HORN TROMBONE CELLO
32'	TUBA DOUBLE-BASS BASS GUITAR

10. WAVEFORM SWITCH

This switch selects the VCO output waveform.

• TRIANGLE WAVEFORM (\wedge)

The triangle wave contains the same harmonics as the square wave, but they are much lower in intensity. For this reason, these harmonics do not stand out and the triangle wave sounds almost as clean and pure as a sine wave. This waveform is often used for flute-like sounds, whistling, and similar sounds.

• SAWTOOTH WAVEFORM (\nearrow)

The sawtooth wave is very rich in harmonics and therefore is used very often. It is particularly suitable for brass and string sounds, and for sounds which only the synthesizer can produce.

• SQUARE WAVE (\square)

The square wave is also rich in harmonics, but it contains only the odd numbered harmonics. The pure square wave has a sound quality very much like a clarinet. The clarinet and xylophone are common sounds synthesized with this waveform, as well as sounds peculiar to the synthesizer. One effect which is very often used is the continuous sound of the square wave (without envelope control) accompanied by portamento.

• PULSE WAVE (\square)

When the top and bottom portions of the square wave are unequal, the result is what is called a pulse wave. The harmonic content of the pulse wave will depend greatly on the width of the pulses. It is possible to modulate, or change the pulse width by means of the LFO or the envelope generator.

■ PULSE WIDTH AND PULSE WIDTH MODULATION

Pulse width refers to the ratio of the widths of the top and bottom portions of the pulse wave. Pulse width is measured in percentages as shown in the drawing at the right. 10% pulse width produces a sound very rich in harmonics and is often used for synthesizing sounds such as the oboe, bassoon, and human voice. Note that a 50% pulse width is nothing more than a square wave.

In addition to using fixed pulse widths, it is possible to modulate the pulse wave so that the width of the pulses varies continually, as shown in the drawing at the right.

Using the LFO to modulate the pulse width produces chorus-like sounds. The output of the envelope generator can be used to modulate the pulse width to produce sounds very much like those of pizzicato strings.

11. PWM MODE SWITCH

With this switch at MANUAL, the pulse widths may be set manually by means of the PULSE WIDTH MOD slider. In LFO, the pulse width will be modulated by the LFO output, and in ENV-1, by the output of ENVELOPE GENERATOR 1.

12. PULSE WIDTH MOD SLIDER

With the PWM MODE switch at MANUAL, this control allows manual adjustment of the pulse width. Note that the lowest position, 50%, will produce a square wave. At the top is MIN (minimum) which produces a pulse width of about 10%.

With the PWM MODE switch set at LFO or ENV-1, this slider controls the depth of the LFO or ENV-1 modulation.

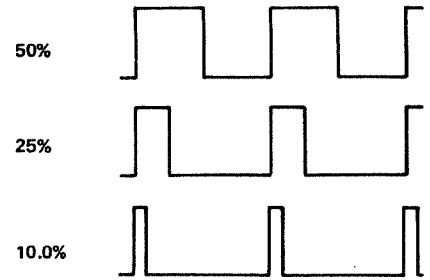

■ PWM by LFO

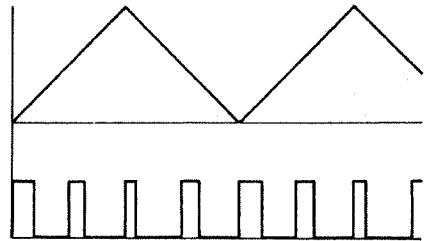

■ PWM by ENV-1

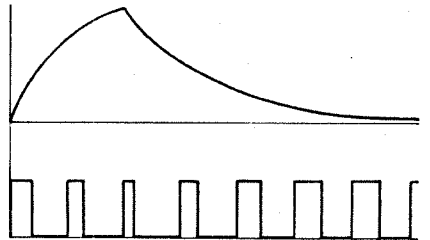

TWO VCO'S IN COMBINATION

A large variety of sounds is possible when the outputs of both VCO's are combined

1. THE SAME WAVEFORM IN THE SAME RANGE

Usually the same waveforms in the same ranges (as shown below) are used for two note chords.

For the one note performance, the sound becomes rich and soft with a chorus effect caused by the slight differences in pitch of the two VCO's.

In both cases it is recommended to set the balance at equal levels with the AUDIO MIXER. Set the SYNC switch at OFF except for special purposes. Only one note will sound even when two notes are played if this switch is on.

2. THE SAME WAVEFORM IN DIFFERENT RANGES

The figure below shows the combination of the triangular waveforms of 8' and 2', which can be used to produce the sound of a vibraphone, for example. This combination is very useful. It is often used for making organ-like sounds, for example. For this purpose, the combination of 2 2/3' or 1 1/3' will be effective. These can be obtained by tuning VCO-2 a perfect fifth above VCO-1 with the VCO-2 TUNING control.

Large sounds can be obtained with combinations of the various square wave (as explained in the description of VCO-1(A)) as well as the sawtooth waveform.

The correct adjustment of the AUDIO MIXER controls is very important since the sound will vary greatly with different balances.

3. DIFFERENT WAVEFORMS IN DIFFERENT RANGES

Among combinations of this kind, the most useful is to combine a sawtooth or square wave with a triangle wave of a different range.

The 8' sawtooth is added to the 16' triangular waveform in the figure below; the tone color of the sawtooth wave is retained but the sound becomes heavier with the intensified bass.

Adding a higher range sound of 2' or 4' can produce special tone colors. In addition, combination of sounds of two or three octaves distant such as 8' and 32' or 4' and 32' is effective.

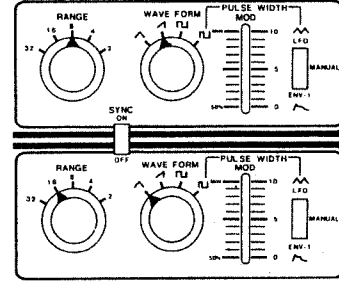
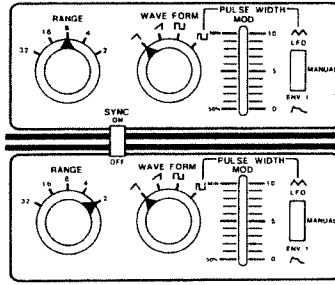
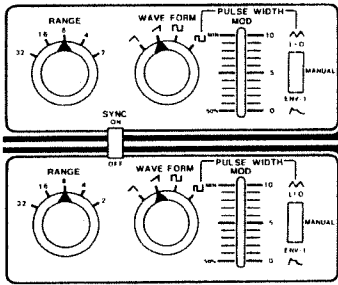

■ WAVEFORMS AND HARMONICS

All waveforms except the sine wave can be generated by a combination of a fundamental sine wave of the pitch frequency and a group of sine waves which are multiples of the fundamental; therefore, any waveform can be synthesized by combining a fundamental sine waveform with a proper ratio of harmonics.

The drawing below shows a fundamental with its harmonics. The white notes are even numbered harmonics and the black notes are odd numbered harmonics. (True harmonics are actually slightly different from the pitches produced by the equally tempered scale.) All waveforms, except the sine wave, contain harmonics. It is this harmonic content that gives each sound its particular tone color.

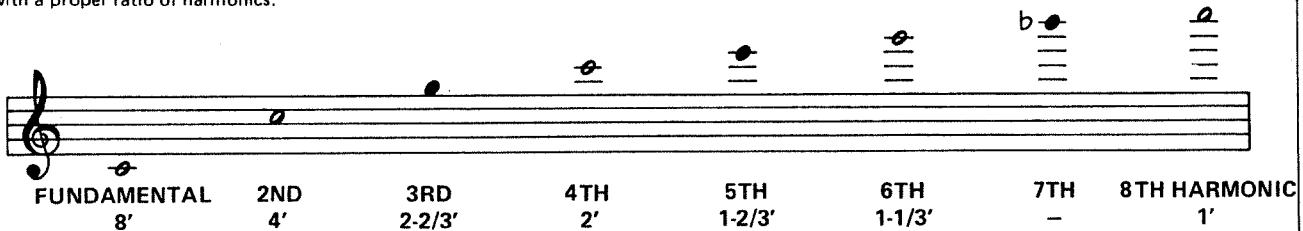

RING MODULATOR — NOISE GENERATOR — AUDIO MIXER

■RING MODULATOR

The RING MODULATOR is used mainly for metallic sounds like bells and gongs, and for unrealistic effects sounds.

The RING MODULATOR has two inputs; the output is the sum and difference frequencies of the two inputs. The two input frequencies, then, determine the qualities of the output sound.

1. VCO-2/EXT SIG SWITCH

One input to the RING MODULATOR is the output from VCO-1(B). The other input is determined by the position of this switch. With this switch, it becomes possible to combine an external signal with VCO-1(B) for ring modulation.

When combining the two VCO's, the resulting sound will depend on the difference in pitch of the two VCO's. The tuning of VCO-2 is important.

When the two VCO's are tuned to unison, very little change in the tone color will occur, although the pitches will be one octave higher than normal. Tuning the VCO's to different frequencies will produce the tone color characteristic of the RING MODULATOR. Interesting effects can be obtained using the two note function of the keyboard, since, if different intervals are played, the RING MODULATOR will receive frequencies of different ratios.

Interesting effects can also be obtained with S/H control of one or both VCO's, and by varying the amount of S/H modulation of one or both VCO's.

When using an external sound source, it is important that the level of the external sound which reaches the RING MODULATOR be near the level of VCO-1(B). This can be done by first setting the EXT SIG INPUT switch on the rear panel at the correct position, then adjusting output level of the external source, or by changing the distance between the sound source and the microphone.

■NOISE GENERATOR

The NOISE GENERATOR is used as the sound source for effect sounds like wind, surf, and thunder.

To synthesize wind sounds, raise the VCF RESONANCE control about half way and move the VCF CUTOFF FREQ control slowly up and down. Another way is to use the output of the LFO to control the VCF cutoff frequency. Or, for random wind patterns, use the output of the S/H set at random.

To synthesize thunder, raise the VCF RESONANCE control all the way up and modulate this with noise.

2. WHITE/PINK SELECTOR

Two types of noise are available: white noise and pink noise.

White noise is the random combination of all frequencies. This kind of noise is like the hissing sound which can be heard when an FM tuner is set at a point where there is no station broadcasting. Pink noise is similar, but has some of the higher frequencies filtered out to produce a sound more like a waterfall.

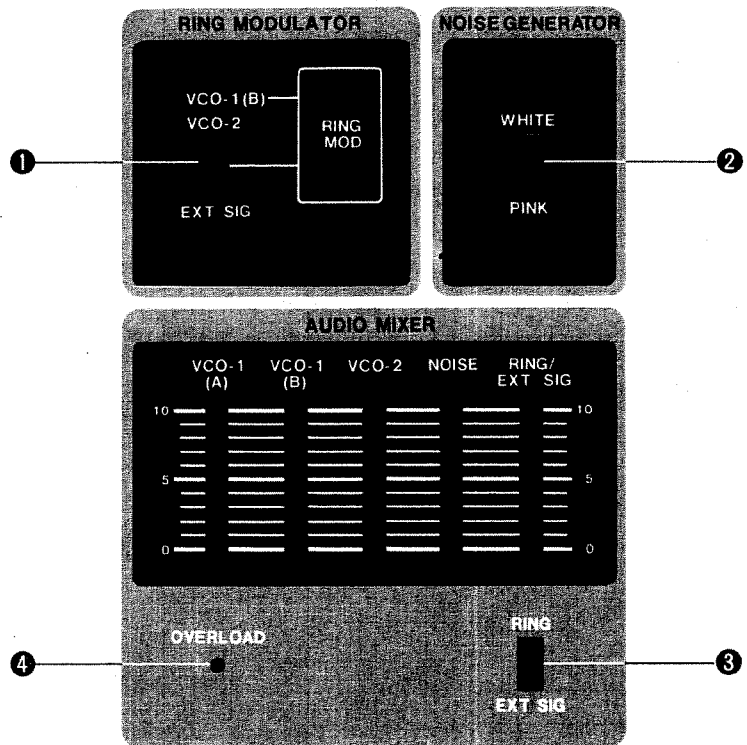

■AUDIO MIXER

This mixer mixes outputs of the VCO's, Noise Generator, RING MODULATOR, and the external input signal.

3. RING MODULATOR/EXTERNAL INPUT SELECTOR

Set this Selector to RING position or to EXT SIG as desired.

4. OVERLOAD INDICATOR

This indicator lights when the combination of mixing levels is excessively high. To reduce distortion at VCF and VCA, keep the output low enough that this indicator does not light.

Pay particular attention to this indicator when mixing signals from the RING MODULATOR or external source.

HIGH PASS FILTER

Before entering the VCF, the signals mixed in the AUDIO MIXER pass through the HPF (High Pass Filter). The HPF blocks low frequencies and passes high frequencies.

With the CUTOFF FREQ control at its lowest position, all sounds pass through the HPF without change; this may be thought of as its normal position. When the CUTOFF FREQ control is raised, the HPF will remove the lower harmonics from the sound source, thus brightening the sound. It is normal for higher positions of this control to produce lower levels of output sound; compensate for this by raising the TOTAL VOLUME control.

The HPF can be used for synthesizing harpsichord and oboe sounds, for example.

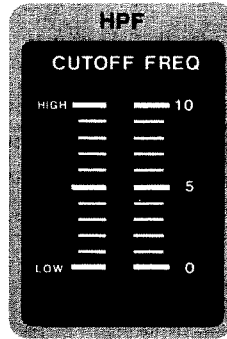

VCF - VOLTAGE CONTROLLED FILTER

The VCF is a low pass filter whose cutoff frequency (or filtering characteristics) can be controlled by means of a control voltage. The VCF, being a low pass filter, acts in a way opposite to that of the HPF. It passes low frequencies and blocks high frequencies.

1. CUTOFF FREQ CONTROL

This control determines the frequencies which will be removed by the VCF. At its highest position, all sound passes through the VCF without change, thus this may be considered its normal position. If the control is slowly lowered, it will begin to shave off the upper harmonics of the sound passing through the VCF. In its lowest position, the VCF CUTOFF FREQ control will remove all frequencies so that the VCF blocks all sound.

NOTE: If the synthesizer produces no sound, this is one of the first things you should check.

2. RESONANCE CONTROL

This control accents the frequencies at the cutoff point of the VCF. At "0", the RESONANCE control has no effect. The effect will become stronger the higher the control is raised. At about "8", the frequencies at the cutoff point are accented so strongly that the VCF starts to oscillate by itself, or in other words, it begins generating a sine wave even with no input to the VCF. The frequency of this sine wave will depend on the position of the VCF CUTOFF FREQ control.

• The VCF CUTOFF FREQ control gives manual control over the cutoff frequency point of the VCF. The following group of controls allows the cutoff frequency to be controlled by means of control voltages.

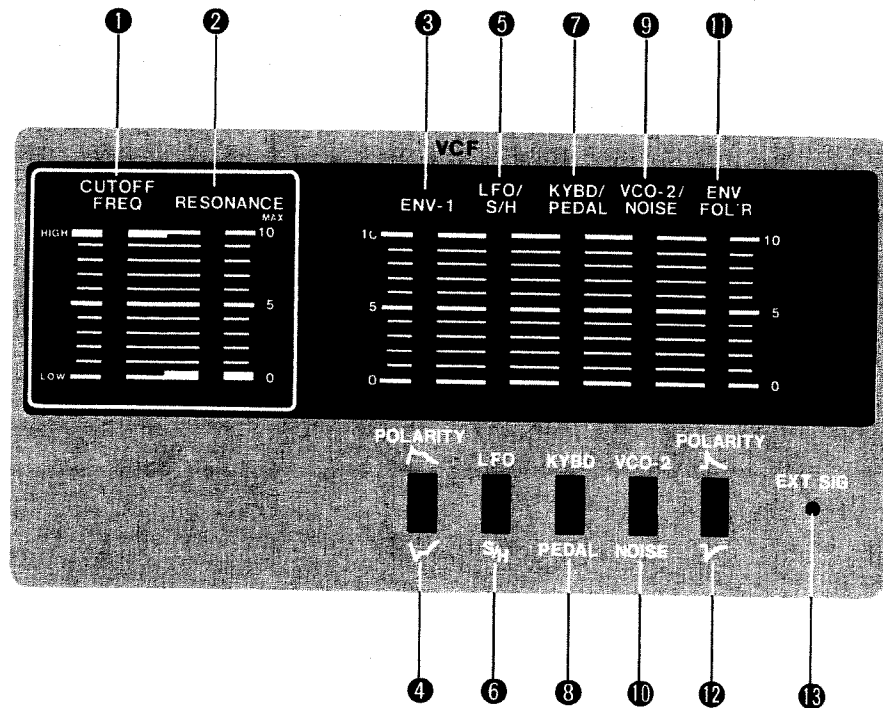

3. ENV-1 CONTROL

With this control raised, the cutoff point of the VCF will change during the production of each note, following the pattern dictated by the setting of ENVELOPE GENERATOR 1. This type of VCF modulation is very often used with brass sounds.

The polarity of the envelope control voltage which reaches the VCF is determined by the ENVELOPE POLARITY switch (4). In the positive () position, the VCF cutoff frequency point will rise, following the shape of the envelope, each time the envelope generator is triggered. Since the cutoff point rises, the CUTOFF FREQ control should be kept away from its HIGH position, otherwise the envelope will have no effect.

With the ENVELOPE POLARITY switch in the negative () position, the cutoff point of the VCF will fall, following the envelope pattern, thus, for this position, the CUTOFF FREQ control should be kept away from its LOW position for the envelope to affect the VCF.

5. LFO (S/H) CONTROL

This control allows the VCF cutoff point to be controlled by either the LFO or S/H, depending on the position of the LFO/S/H switch (6).

In the LFO position, the VCF cutoff point will follow the output of the LFO. Using the sine wave () output of the LFO produces growl sounds.

In the S/H position, the output of the S/H can be used to produce tone color patterns which change in steps, either randomly or in fixed patterns.

Some of the above affects will not be noticeable with the VCF CUTOFF FREQ control at one

or the other of its extreme positions. For greater tone color variety, try raising the RESONANCE control.

This control is also effective for processing of external input signals. Continuous wah wah effects and stepwise tone color changes can be added to electric guitar or other electronic keyboards.

7. KYBD/PEDAL CONTROL

This control allows control of the VCF cutoff point by means of the keyboard control voltage or an external foot pedal, depending on the position of the KYBD/PEDAL switch (8).

The tone color of many instruments will change with pitch; this effect can be produced by means of keyboard control voltage control of the VCF cutoff point. When the slider is set at maximum, the VCF cutoff frequency will change at the rate of 1 volt/1 octave, and the VCF CUTOFF FREQ control will have to be set a little lower than it would be without keyboard control.

With the selector switch (8) at PEDAL, the VCF cutoff point can be controlled manually by means of a foot pedal. The slider will then determine the margin of control obtainable with the pedal. The PEDAL position also gives control of the VCF cutoff frequency point to the keyboard control voltage, but at the fixed rate of 1 volt/1 octave.

9. VCO-2/NOISE CONTROL

This control allows the VCF cutoff point to be controlled by means of the VCO-2 output or by noise, depending on the position of the selector switch (10).

As examples of how these can be used, RING MODULATOR-like sounds can be produced by raising the VCF RESONANCE control to "10"

and modulating this with the output of VCO-2 (VCO-2/NOISE slider at "10"). If NOISE is used instead of VCO-2, thunder-like sounds and gun shots can be obtained. In both of these cases (VCO-2 and NOISE modulation), all the AUDIO MIXER controls should be set at "0".

11. ENV FOL'R CONTROL (ENVELOPE FOLLOWER)

This control will allow the VCF cutoff point to follow the level of an external audio signal.

With the POLARITY switch (12) at (), the cutoff point will be driven higher for louder sounds and at (), lower for softer sounds. For good wah effects, set the VCF CUTOFF FREQ control near LOW for () and near HIGH for (). If the wah effect is insufficient even with the ENV FOL'R slider at "10", change the position of the EXT SIG INPUT LEVEL switch (#7, p. 5) to the next higher step.

The best wah effects are obtained with instruments whose sounds decay slowly, such as guitars and pianos. It is also interesting when used with wind instruments and the human voice.

The LED (13) lights whenever a cord is plugged into the EXT SIG INPUT jack on the rear panel.

VCA — VOLTAGE CONTROLLED AMPLIFIER

The VCA is an amplifier whose gain is controlled by a control voltage. In other words, the varying control voltage acts much like a volume control to any sound passing through the VCA. If the output of the envelope generator is used to control the VCA, then the sound passing through the VCA will take on a loudness pattern corresponding to the shape of the envelope voltage.

1. ENVELOPE SWITCH (ENV-1/ENV-2)

This switch decides which of the two envelope generators will control the VCA. At ENV-1, the envelope used for control of the VCF is also used for the control of the VCA. The ENV-2 position allows the VCA to be controlled by a separate envelope.

2. HOLD CONTROL

When there is no envelope, the VCA is "closed" and will not pass sounds. Raising the HOLD control will "open" the VCA to let sounds through. It is most often used when it is desirable to control the sound envelope entirely by means of the VCF, or when tuning the synthesizer, or when processing external sound sources.

3. LFO CONTROL

This is for controlling the VCA by means of the LFO. By raising this control, you can obtain tremolo effects.

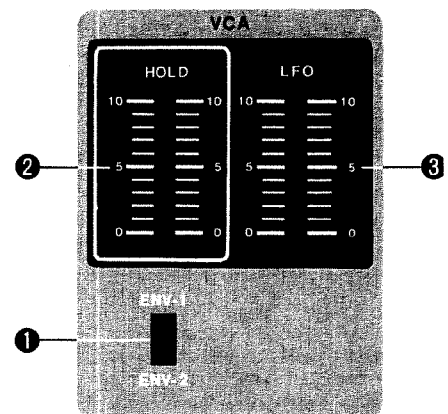

ENVELOPE GENERATOR

Depressing a key on the keyboard triggers the envelope generator into action. The envelope generator generates a control voltage which varies with time according to the control settings. This control voltage is used to control the VCF cutoff frequency point so as to vary the tone color during the production of a note, and/or it is used to control the VCA to give the output sound its loudness contour. The drawing on the right shows the four parts of an envelope.

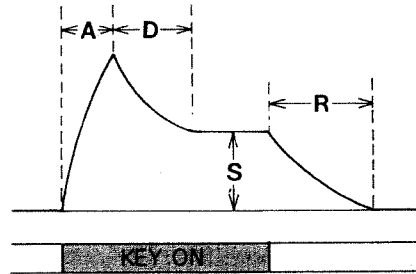
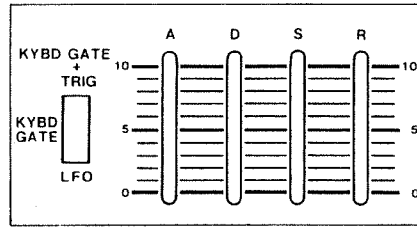

1. A (ATTACK TIME) CONTROL

This slider controls the amount of time which is required for the voltage to reach its maximum level after a key is depressed. This is called attack time.

2. D (DECAY TIME) CONTROL

This slider controls the amount of time required for the voltage to fall to the level set by the SUSTAIN control. This time is called decay time.

3. S (SUSTAIN LEVEL) CONTROL

This slider determines the level to which the voltage will fall at the end of decay time. Once this level is reached (at the end of decay time) it will be held until the key is released.

Note that if the SUSTAIN control is set at maximum, there will be no decay time since the voltage level cannot fall to maximum. With the SUSTAIN control at maximum, then, the DECAY control has no effect.

4. R (RELEASE TIME) CONTROL

This slider determines the amount of time required for the voltage to fall to minimum level after the release of the key.

Note that ATTACK, DECAY, and RELEASE control time elements and SUSTAIN controls level.

5. GATE TRIGGER SELECTOR SWITCH

This switch selects the pulse which will activate the envelope generator.

This switch is usually set at GATE + TRIG or GATE for triggering the envelope generator each time a key is depressed.

A gate pulse is a constant voltage which is produced when any key is in the depressed position. The action of depressing a key generates a short pulse called a trigger pulse.

The gate portion of the keyboard output actually consists of two simultaneously generated pulses. The gate pulse is merely a constant voltage which appears any time one or more keys are in the depressed position. In other words, it is like the output of a light switch. Depressing one or more keys turns the voltage on; when all keys have been released, the voltage goes off.

The trigger pulse is a short pulse which is generated when a new key is depressed. When two or more keys are pressed, a trigger pulse will be produced each time the highest key in the group is depressed or released.

The KYBD + GATE position of this switch might be considered its normal position. This position will trigger the envelope generator for each note in a passage played legato. It is also useful for playing fast trills very easily. This is accomplished by holding down the lower note in the trill while repeatedly tapping on the key for the upper note of the trill (the KYBD MODE switch should be in the ONE NOTE position).

The GATE position of this switch is useful in legato passages where it is desirable to produce only one envelope for the complete phrase. This position is also better when playing two notes (KYBD MODE switch in TWO NOTE position).

In the LFO position, depressing a key will cause the envelope generator to be triggered by the LFO. This is useful for producing rapidly repeating notes such as those sometimes used in mandolin playing. In addition, this position synchronizes the LFO output to the keyboard so that the pattern of repeated notes will always start the instant a key is depressed.

■ GATE & TRIGGER

KEY



GATE



TRIGGER



ENV OUTPUT WAVEFORM (GATE + TRIGGER)



ENV OUTPUT WAVEFORM (GATE)



■ ADSR SETTING VS ENVELOPE WAVEFORM

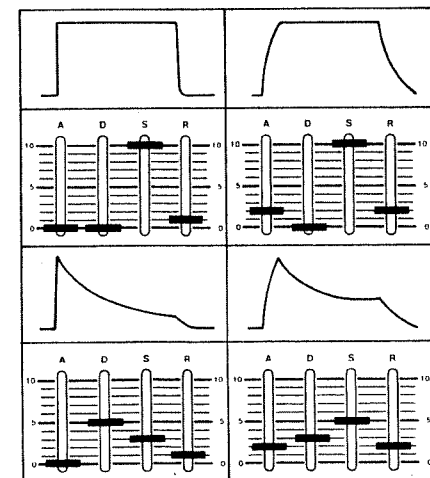

The SH-7 incorporates two envelope generators of this kind, with independently variable envelope parameters. Usually, the VCF is controlled by ENV-1 and the VCA by ENV-2. Use ENV-1 when you want to control both VCF and VCA with the same envelope.

* CAUTIONS FOR SETTING ADSR

When all the envelope controls are set at "0", an extremely short pulse is produced. Note that only a click noise is generated if the VCF or VCA is controlled by this kind of envelope.

SAMPLE/HOLD

The S/H (Sample and Hold) produces voltage sequences, either in fixed patterns or at random, by sampling input waveforms from the LFO. Each sample represents the voltage level at the instant the sample was taken. The HOLD portion of the circuit holds this voltage level until the next sample is taken. The result of this is a control voltage output which changes stepwise. When used to control a VCO, this produces arpeggio-like runs of notes or notes with random pitch patterns. When used to control the VCF cutoff frequency point, it produces interesting tone color patterns. These tone color patterns can also be very effectively used with external sound sources such as from a guitar or string synthesizer.

1. MODE SWITCH

This switch decides which waveform will be sampled. The \nearrow and \nwarrow positions sample waveforms from the LFO, and the RANDOM position samples the output of the NOISE GENERATOR.

2. SAMPLE TIME CONTROL

This control determines the intervals of the sampling pulses. The sampling rate can be visually checked by means of the LED above the MODE switch. Moving the SAMPLE TIME control higher will produce a faster sampling rate.

The drawing below shows a few of the patterns which are possible when using the S/H output to control a VCO. In these examples, the SAMPLE TIME rate is several times faster than the rate of the LFO. In the first two examples, it is possible to produce a great variety of musical patterns by varying the frequency of the sampled waveforms (by changing the LFO RATE control) and/or varying the SAMPLE TIME.

3. OUTPUT LAG CONTROL

Raising this slider will "soften" the voltage changes so that pitches will have a keyboard-like portamento effect.

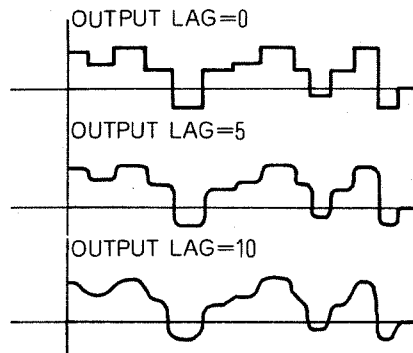
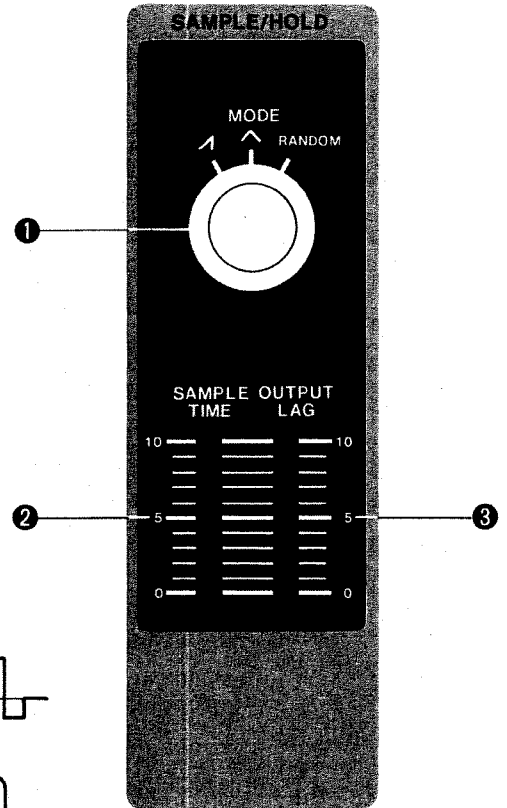

•S/H OUTPUT WAVEFORM BY EACH SAMPLING MODE.

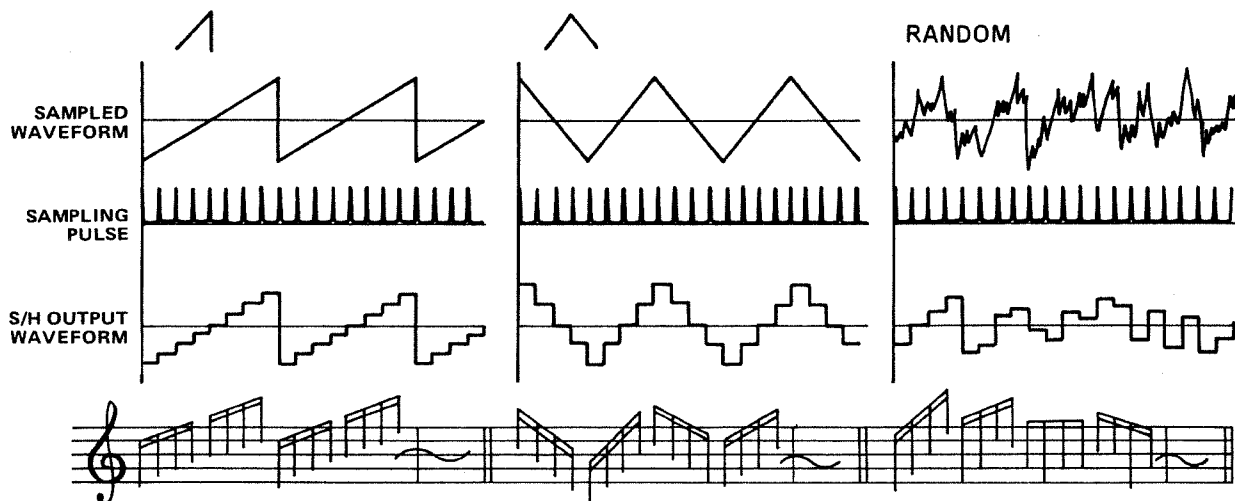

LFO — LOW FREQUENCY OSCILLATOR

The LFO is an oscillator which generates waveforms of a low frequency. The range is from about 0.2Hz to about 25Hz. The output of the LFO can be used for modulating the VCO, VCF, or VCA, and for triggering the envelope generators.

1. WAVEFORM SWITCH

This switch determines which waveform will be used for VCO, VCF, and/or VCA modulation. The sine wave is the most commonly used waveform. Controlling the VCO, it produces vibrato effects, or pitches which sweep up and down. Controlling the VCF, it produces growl effects (with faster LFO rates) or tone color vibrato, which occurs in some instruments in conjunction with pitch vibrato. Controlling the VCA, it produces tremolo effects, which is a slight varying of the loudness.

The other waveforms are more often used for special effects. For example, using the square wave to modulate the VCO pitch will produce trills.

2. RATE CONTROL

The RATE slider controls the frequency of the waveforms. Raising the control increases the frequency. The frequency can be visually checked by means of the LED. For vibrato-like effects, this control is normally set at about "5"

3. DELAY TIME CONTROL

When this control is raised, pressing a key on the keyboard will produce a delayed entry of the sine wave. This is especially effective for delayed vibrato effects, such as in the musical example shown below. Delayed sine wave is also useful for delayed growl or wah wah, and for delayed tremolo. If delayed entry of the sine wave is not desired, then this control must be set at "0". (The other LFO waveforms are not affected by this delay effect).

4. KYBD TRIG (KEYBOARD TRIGGER) SWITCH

The normal position of this switch is OFF. When it is ON, the frequency of the LFO is locked to the keyboard gate pulse. What this means is that when a keyboard gate pulse appears, it triggers the LFO to begin its wave generating process from the beginning, or in other words from the highest level contained in the waveform. With some uses of the LFO, this is a desirable feature. The drawing at the right shows what happens to each of the LFO waveforms when a gate pulse occurs.

When triggering the envelope generator with the S/H clock (KYBD MODE switch in EXT CV/ GATE/(S/H) position), leave the KYBD TRIG switch OFF.

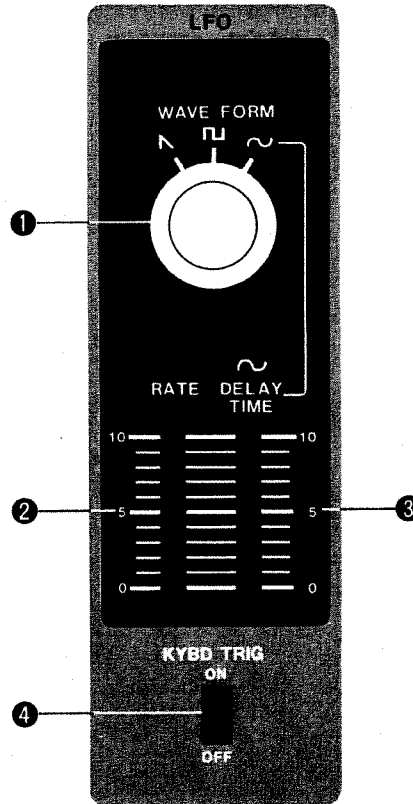

■ FUNCTION OF KEY TRIGGER

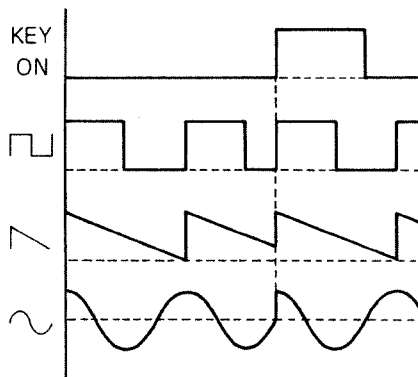

■ EXAMPLE OF DELAYED VIBRATO



Experiment it with 7. VIOLIN of SAMPLE SOUND PATCHES — GROUP 3. STRING INSTRUMENT.

CONTROLLER

■PORTAMENTO

Portamento is the sliding of a note from one pitch to another. The synthesizer is the only keyboard instrument which can produce portamento effects. Through the effective use of the SH-7 portamento feature you can create portamento effects like those sometimes used with trombone and violin playing.

1. PORTAMENTO TIME CONTROL

This controls the time required for the change of pitch. As this knob is turned clockwise (↻), the portamento time is increased. At the extreme counterclockwise position no portamento is in effect.

2. PORTAMENTO MODE SWITCH

In the UP position, portamento is effected only when a key higher than the last played note is depressed. In the DOWN position, it is effected only when a key lower than the last played note is depressed. At NORMAL, portamento is effected in both directions.

3. TRANPOSE SWITCH

The TRANPOSE switch transposes the keyboard pitches up or down one octave. L = LOW range; M = MIDDLE range, and H = HIGH range.

4. TOTAL VOLUME

This controls the total volume of the output sound from SH-7. Changing the tone color by means of the VCF sometimes causes a change in the volume of sound. In such cases, the TOTAL VOLUME should be adjusted with this knob.

■BENDER

This section functions for changing the pitch, tone color, or volume by means of the BENDER lever (5). The BENDER variation of the pitch is very effective for imitation of guitar choking.

Also, by means of the mode switches, the depth of LFO control of VCO (vibrato), VCF (growl), and VCA (tremolo) can be controlled with the BENDER lever.

5. BENDER LEVER

This is the lever which controls the bend effects. It has a click-stop at center with a spring return to center. When using the BENDER for control of LFO depth, the lever may be moved in either direction, the effect is the same.

6. SENSITIVITY CONTROLS

These knobs control the sensitivity of the BENDER on each effect.

7. CONTROL MODE SWITCHES

These switches decide which BENDER function will be in effect. At OFF, the BENDER effect is cancelled. At CV, the control voltage (CV) output of the BENDER lever is used to control

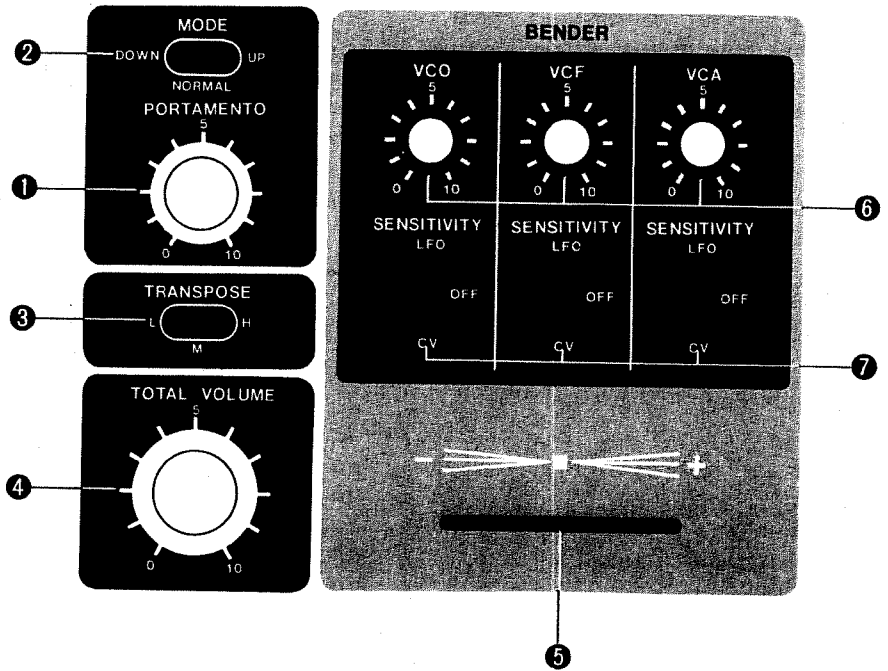

the effect, with the related SENSITIVITY knob controlling the depth of the effect when the BENDER is at either of its maximum positions. For example, with the VCO section SENSITIVITY knob at maximum, it is possible to get a ±one octave variation of VCO pitch. This section may also be used for transposing parts during the progress of the music. This can be done by tuning the synthesizer in the normal way, then, with the BENDER control at maximum ("+" or "-"), as the case dictates) and the MODE switch at CV, use the VCO SENSITIVITY knob to tune the VCO to the transposing pitch desired. With this arrangement, a simple movement of the BENDER lever will instantly transpose the synthesizer to the desired key.

With the CONTROL MODE switches in LFO, the SENSITIVITY knobs will control the maximum depth of the LFO effect.

For example, with LFO control of the VCO, the BENDER lever will determine the depth of the LFO effect with the SENSITIVITY knob determining the maximum depth available with the BENDER lever. With this arrangement, it is possible to control the depth of vibrato, for example, by hand by means of the BENDER lever.

BENDER effects on the VCO, VCF, and VCA may be used completely independent of each other, or simultaneously in any combination. The connections between the BENDER section outputs and the respective modules (VCO, VCF, VCA) are made internally and have no relation to the settings of other controls, thus BENDER control may be quickly and simply put into effect using only the SENSITIVITY knobs and the CONTROL MODE switches.

■EXAMPLE OF USE WITH PORTAMENTO "UP" MODE

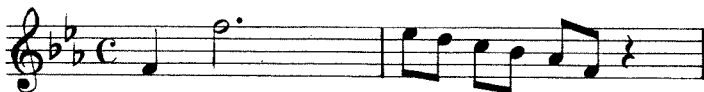

CAUTIONS

(1) With two note performance, the two notes are sounded separately while the two keys are kept depressed, but after one of the keys is released, only one note is sounded, depending on which key is released first, as shown in EX-AMPLES 2 and 3 on the right. For two note performance, it is recommended to use a short envelope release time and to use an echo or reverb unit to make the music sound more natural.

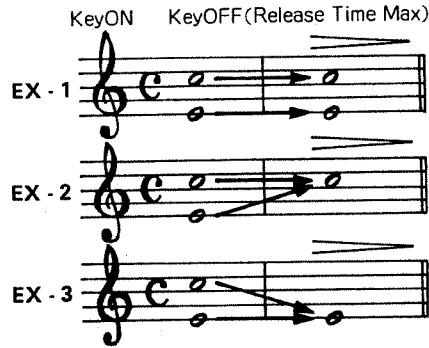

(2) When the envelope generator TRIGGER MODE switch is set at LFO, the envelope generator will be triggered by the LFO only when a key is depressed.

With this arrangement, the LFO waveform always starts over the instant a key is depressed, and the envelope generator is triggered from the beginning.

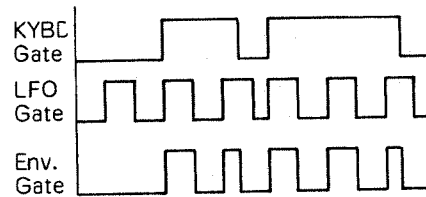

(3) When controlling LFO effects with the BENDER using the sine wave () output of the LFO, the LFO DELAY TIME control should normally be left at "0" since a delayed entry of the sine wave is usually not desirable.

(4) When triggering the envelope generator from the S/H clock, the LFO KYBD TRIG switch should be in the OFF position.

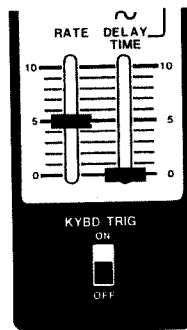

To control LFO modulation depth with the BENDER, set DELAY TIME control at minimum.

• If you cannot produce the desired sound, check the following items:

CONTROL SECTION

- (1) Check to see if controls other than those needed are actuated. Are VCO controls (LFO, AUTO BEND, S/H) set too high? Is the LFO RATE control set properly (usually around "5")? Also check the setting of the controls for controlling the VCF and VCA with the LFO. Also, check the KEY MODE switch and selector switch for the envelope generator.
- (2) If no sound is produced at all, check to see if the mixer levels are set at minimum and if the TOTAL VOLUME control is too low. If the HPF control is set too high or if the VCF CUTOFF

FREQ control is set too low, no sound will be produced. Also check the envelope generator settings.

- (3) If sound is produced continually, lower the HOLD level.

OTHER POINTS:

- (1) Are the POWER switches of the SH-7 and amplifier on?
- (2) Are volume controls of the external amplifier, mixer, etc. raised?
- (3) Are connections correct? (See page 5.)
- (4) Are the cords defective?

(5) When using the EXT SIG INPUT jack, be especially careful of the setting of the sensitivity selector (H/M/L).

The STANDARD INPUT LEVELS shown in the table on the right indicate the levels at which the overload indicator (LED) will light with the EXT SIG control set at maximum. If the input level is lower than these levels, VCF activation by the envelope follower may not be satisfactory. If the input level is so high that it exceeds the maximum acceptable input level shown in the table, even when the EXT SIG control is lowered, the sound may be distorted. When using a microphone, setting it too close to the sound source may cause distortion. Be very careful about the distance between the source and the microphone. When using other electric or electronic instruments, it is important to match their output level to the SH-7.

In some cases it may be desirable to intentionally cause distortion effects by overloading the SH-7 inputs.

NOTE: DO NOT APPLY AN EXCESS OF ±15 VOLTS TO ANY SH-7 INPUT.

The common positions for sources are:

- H . . . microphones
- M . . . electric/electronic instrument
- L . . . audio devices (line level)

(6) Even when SYNC switch is set at ON, synchronization may fail if the VCO's are too far out of tune and/or if two distant keys are depressed simultaneously. Before setting the SYNC switch to ON, tune VCO-2 to unison with VCO-1. Also be sure to set the KEY MODE switch at the ONE NOTE position.

With the SH-7 synchronization function, the synchronization mode varies depending on the phase relationship at the time it is turned on. As

SENSITIVITY SELECTOR (IMPEDANCE)	STANDARD INPUT LEVEL	MAXIMUM INPUT LEVEL
H (10KΩ)	-43dBm (14mVp-p)	-32dBm (50mVp-p)
M (100KΩ)	-18dBm (250mVp-p)	-6dBm (1Vp-p)
L (100KΩ)	0dBm (2Vp-p)	+10dBm (6.3Vp-p)

(1) Never apply over ±15 volts to any SH-7 input.

(2) The FREQ and WIDTH controls under the rubber covers on the rear panel are for use by qualified electronic technicians. Do not touch these since even a very slight change in these can change the synthesizer pitch relations and render the synthesizer useless as a musical instrument.

shown in the table below, when two VCO's are set at the same range and at the same waveform, the tone color and volume may change depending on the timing of the SYNC switch operation. It is possible to change tone colors by making use of this unique characteristic.

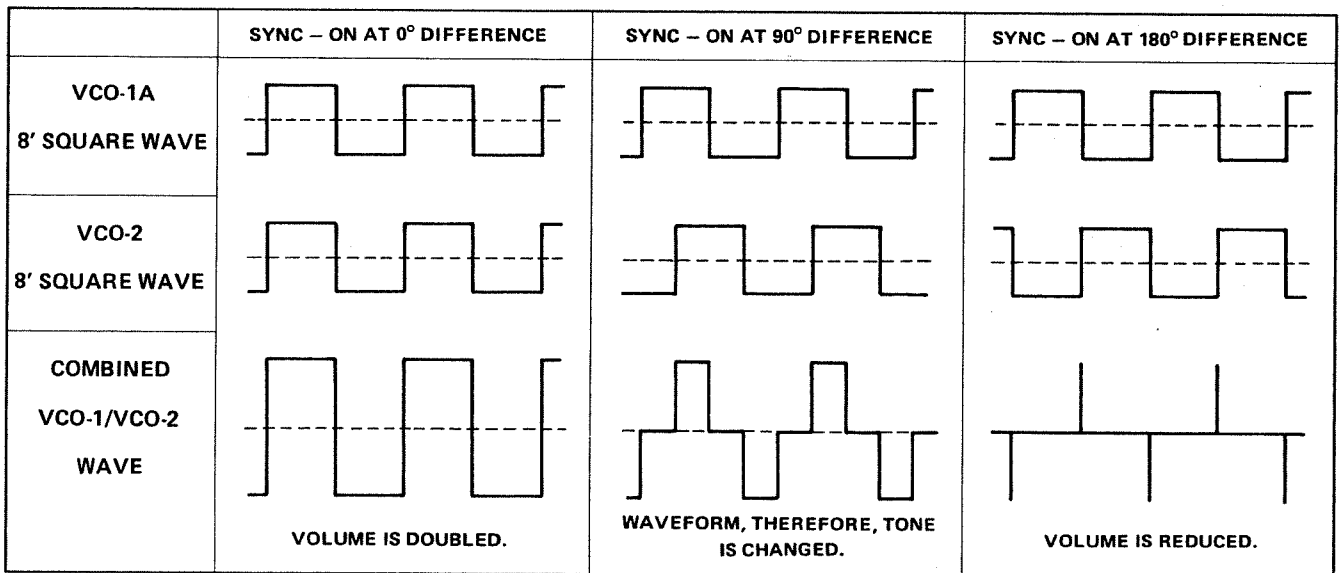

BASIC METHOD OF SOUND SYNTHESIS

BASIC PATCH

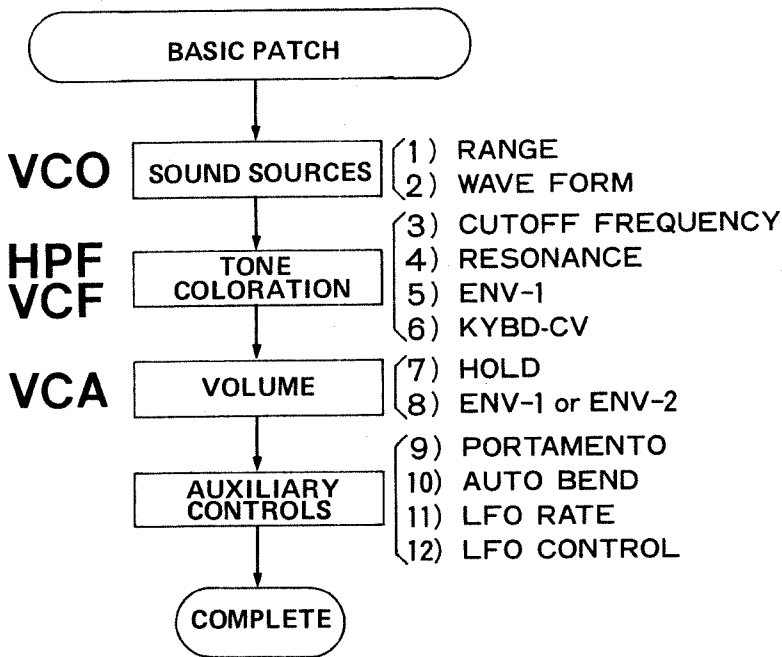
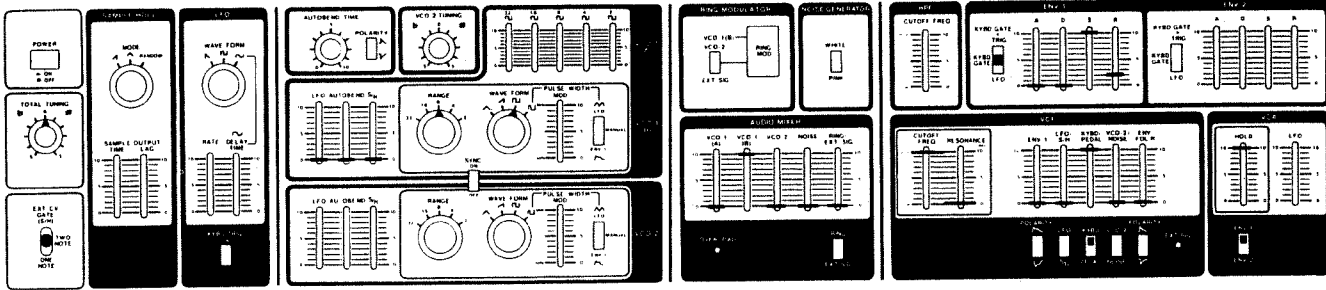

The above diagram shows what could be called a "basic" patch. Unmarked controls can be left in any position. This patch produces a continuous square wave output. The frequency of the square wave will depend on which key on the keyboard was last pressed. Since continuous sound is produced, this patch is useful as a test pitch for setting up stage or studio equipment.

To produce sound only with key depression, lower the VCA HOLD control and raise the "S" (SUSTAIN) control of ENVELOPE GENERATOR 1.

For a more in-depth study of synthesizer theory, we recommend the series of instruction manuals designed for the Roland System 100 Synthesizer. The information contained in these manuals, and the patch diagrams (sound settings) are easily adapted to the SH-7.

WAVEFORM	TRIANGULAR WAVE	SAWTOOTH WAVE	SQUARE WAVE	ASYMMETRICAL SQUARE WAVE	PWM WAVE
RANGE					
4'	WHISTLE	-	XYLOPHONE	HARPSICHORD	-
8'	-	TRUMPET VIOLIN	-	OBOE	ACCORDION (LFO) FUZZ GUITAR (ENV-1)
16'	-	TROMBONE HORN CELLO	CLARINET	SAXOPHONE	-
32'	-	TUBA	-	BASSOON	(BASS GUITAR) (ENV-1)

	FLUTE	VIOLIN	TRUMPET	HARPSICHORD	XYLOPHONE
ENVELOPE WAVEFORM					
ADSR SETTING					
VCA CONTROL	<input type="radio"/>	<input type="radio"/>	<input type="radio"/>	<input type="radio"/>	<input type="radio"/>
VCF CONTROL	<input type="radio"/>	<input checked="" type="radio"/>	<input type="radio"/>	<input checked="" type="radio"/>	<input type="radio"/>

■SYNTHESIS

The synthesis of sound is an art in itself. The most important ingredients to its mastery are practice and patience. In this case, we mean practice in the sense of familiarity with the controls and their effects on the sound, as well as keyboard playing technique. When setting the synthesizer so as to create sounds, always try to be aware of why the controls affect the sound the way they do.

Perhaps the best approach to synthesis in general is the imitation of sounds you know. Even if you feel that you may never want to use these types of sounds in the music you play, the practice involved in imitating sounds forms an excellent foundation on which to build. If you can imitate known sounds, then you are well on the road to being able to imitate any sound you might imagine in your head. An imitative sound can also form the starting point for non-imitative or purely electronic sounds. The ability to imitate sounds also gives you a strong insight into the analysis of acoustics. These insights are essential to producing sounds of imaginary instruments; sounds which do not exist in the real world but seem as if they should exist somewhere.

The following gives some hints on how to approach the actual synthesis of specific sounds.

■HOW TO SYNTHESIZE SOUNDS

The three qualities of sound are: pitch, tone color, and loudness. Pitch and loudness usually present little problem in synthesis. If we want to synthesize a piccolo or a pizzicato string bass, it is extremely simple to decide and set the correct pitch range, and by repeatedly depressing a key on the keyboard while adjusting the envelope generator controls, we can easily arrive at the correct envelope for these sounds. Tone color is a different matter, however, and often requires much trial and error to get the desired sound.

This is where practice and patience will pay off.

■PITCH

First set the sound source. The SH-7 has two basic sound sources: the VCO's and the Noise Generator. The Noise Generator is used for synthesizing sounds of indefinite pitch such as wind, thunder, cymbals, etc., or for adding this quality to pitched sounds, such as drums. The VCO's are used for pitched sounds. Set the RANGE and, for the time being, use any waveform output.

■LOUDNESS

Next, set the Envelope Generator. For this, the Basic Patch shown on the opposite page can be used. While repeatedly depressing a key, set the Envelope Generator controls so that the output sound takes on the approximate loudness pattern of the desired sound. The drawing above shows some sample envelopes and Envelope Generator settings.

■TONE COLOR

Tone color should be considered after pitch and loudness because it is often very strongly affected by pitch and loudness. The SH-7 provides five methods for controlling tone color of synthesized sound (excluding the use of an external sound source): VCO's, Noise Generator, Ring Modulator, High Pass Filter (HPF), and Voltage Controlled Filter (VCF). The VCO represents the prime source of tone color for pitched sounds since the output waveform which is selected will determine the tone colors available for synthesizing sound. The Noise Generator represents the prime source of tone color for sounds of indefinite pitch. The two filters are used to remove unwanted harmonics from the sound source. The Ring Modulator is normally the only portion of the synthesizer which is used to add harmonics which are not present in the original waveform. Using two VCO inputs, the Ring Modulator produces metallic clanging sounds.

To set tone color, start by deciding the sound source waveform; the drawing on the bottom of

the opposite page gives some suggestions for various types of sound. If in doubt, try a sawtooth wave to begin with since the sawtooth wave is usually a little more common than the others.

Next, set the filters. For sustaining type sounds (or sounds in which the Envelope Generator SUSTAIN control is at any position other than "0"), depress a key and adjust the filter controls so as to produce a tone color near the desired tone color. Many instruments produce a tone color which is dynamic in quality, or in other words, the tone color changes during the production of each note. This is particularly so with brass instruments and plucked string sounds. This can be imitated by controlling the VCF cutoff point with the Envelope Generator. While repeatedly depressing a key on the keyboard, little by little raise the VCF ENV-1 control. Each time you raise this control, lower the VCF CUTOFF FREQ control slightly to compensate. The tone color of an instrument will also often be slightly different for different pitch ranges. This effect can be produced by using the keyboard control voltage to control the VCF cutoff point. First, readjust your sound so that lower keys on the keyboard produce the tone coloring of the lower pitches. Normally, this tone coloring is darker than the higher pitches. Next, try playing pitches higher on the keyboard. Raise the VCF KYBD/PEDAL control (switch at KYBD) to brighten these upper pitches. Now, try pitches at various places on the keyboard and touch up the VCF controls so that you get the desired effect.

Don't forget that using the VCO Pulse Width Modulation is also another source of tone color which changes.

■OTHER DETAILS OF SOUND

Once the basic sound is set, you are ready to add the extra details to the sound, such as portamento, vibrato, etc. During this process, you will also probably want to touch up the previously set controls to make your sound perfect.

SAMPLE SOUND PATCHES

The word patch refers to the connections and settings of a synthesizer used to arrive at a given sound.

The sample sound patches which appear on the following pages should help to give you a better understanding of how sounds are actually synthesized. They can form the basis for many other sounds in addition to those shown. Many of the controls may have to be readjusted in order to produce the sounds of the instruments given. This is because it is impossible to make

the diagram accurate since sometimes a small change in a control causes a large change in sound. Also, the type of amplifier used will often strongly affect the results.

Many of the sounds you synthesize can be greatly improved by using your amplifier tone controls and/or by using a graphic equalizer such as the Boss GE-10. Also, echo and chorus effects can add greatly to the overall effect.

GROUP 1 — WOODWINDS PAGE 23/24

1. FLUTE
2. CLARINET
3. OBOE

GROUP 2 — BRASS INSTRUMENTS PAGE 25

4. TRUMPET
5. HORN
6. TUBA

GROUP 3 — STRING INSTRUMENTS PAGE 26

7. VIOLIN
8. FUZZ GUITAR
9. BASS GUITAR

GROUP 4 — PERCUSSION PAGE 27

10. XYLOPHONE
11. VIBRAPHONE
12. SNARE DRUM

GROUP 5 — KEYBOARD INSTRUMENTS PAGE 28

13. ELECTRIC PIANO
14. HARPSICHORD
15. ORGAN

GROUP 6 — OTHER SOURES PAGE 29

16. WHISTLE I
17. WHISTLE II
18. BELL

GROUP 7 — SOUND EFFECTS PAGE 30

19. STEAM LOCOMOTIVE
20. WIND
21. GUN SHOTS, THUNDER

GROUP 8 — USING EXTERNAL SOUND SOURCES PAGE 31

22. ENVELOPE FOLLOWER
23. ENVELOPE MODIFIER
24. RING MODULATOR

MANEUVERING BENDER PAGE 32

GUITAR
FUNKY BASS

GROUP 1 — WOODWINDS

1 FLUTE

The flute produces a sound with a very clean and pure tone color. This can be produced on the synthesizer by using the sawtooth wave and highly filtering it with the VCF. Note that the VCF ENV-1 control is raised so that the tone color changes slightly during the production of each note. This is common with wind instruments. You can check the sound of this effect by lowering the ENV-1 control to "0" and raising the VCF CUTOFF FREQ control to about "6". This will produce a tone color about the same as is produced with sustained notes. If you compare these two sounds, you can hear the subtle effect that envelope control has on this particular sound. Also check the effect of the HPF by playing various pitches and moving the HPF CUTOFF FREQ control up and down between "0" and the setting shown. Note the subtle effect

it has on the lower pitches.

Note the use of the VCF LFO/S/H control (switch at LFO) to produce what is called growl. In this case the effect is subtle as it would be in a flute sound. Raise this control to "10", increase the LFO RATE to maximum (and the LFO DELAY TIME to minimum) and you have growl which can be produced only on a synthesizer. Now try the Flute patch as shown, but using the triangle wave. Although the flute and the triangle wave contain few harmonics, the harmonics in the triangle wave are all odd numbered and thus the sound is not very flute-like, but more hollow sounding, like a recorder. This is a good example of how a small change can create a different sound from the same patch.

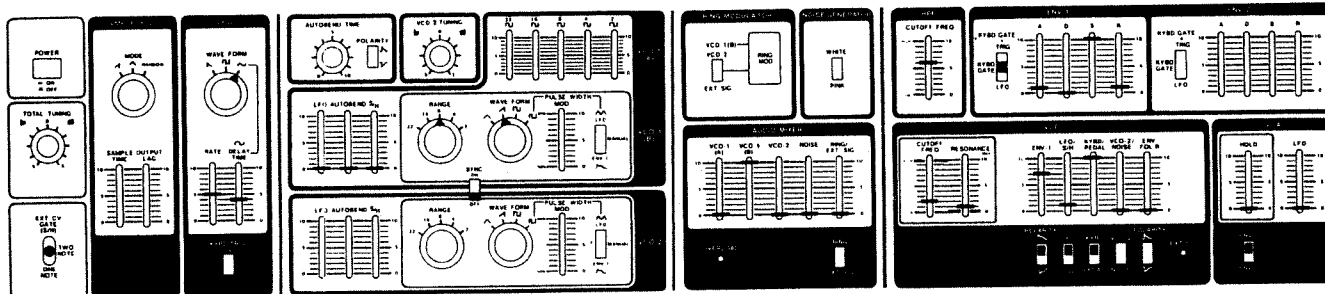

2 CLARINET

Since the square wave all by itself already sounds much like a clarinet, this is a good place to start in obtaining the clarinet sound. The diagram shows the VCO RANGE switch at 16' for a low register clarinet; use 8' for a higher register (or use the TRANSPOSE switch).

As with the flute, we again use the filters to remove some of the harmonics from the square wave, and we use envelope control because the clarinet is a wind instrument.

To produce a bass clarinet, change the RANGE switch to 32', and lower the HPF CUTOFF FREQ control to "0". Also, since the bass clarinet is slightly larger, you may want to increase the ATTACK and RELEASE times very slightly.

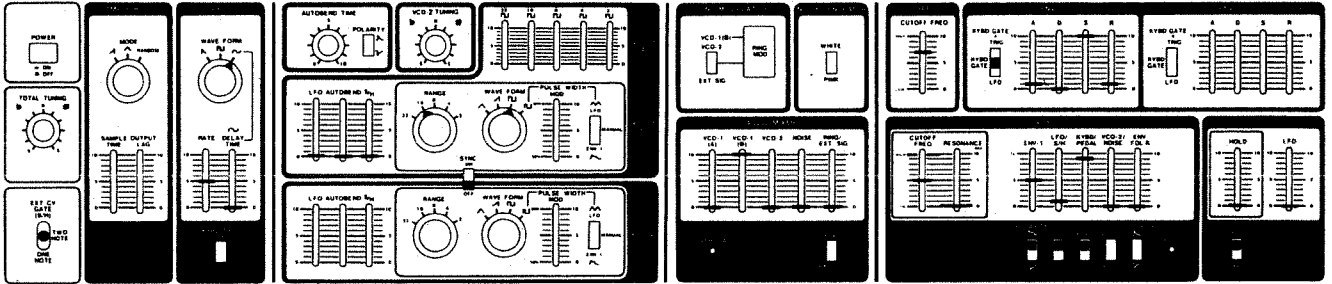

3 OBOE

The pulse wave at 10% modulation (VCO PULSE WIDTH control at "10"; switch at MANUAL) produces a sound with a harmonic content the same as a sawtooth wave, except that these harmonics are much stronger. This rich source of harmonics is a good place to start when synthesizing double reed instruments. The use of the VCF RESONANCE control accents the frequencies at the VCF cutoff point. Try changing the position of the RESONANCE control and note the effect it has on the sound.

This particular sound uses no envelope control of the VCF even though the oboe is a wind instrument. This is because the RESONANCE control is not at "0". Using envelope control would cause the filter cutoff point to change during the production of each note, thus producing a sound not normal to most instruments. To hear this effect, move the VCF ENV-1 control up to about "8" and lower the VCF CUTOFF FREQ control to about "4". This produces an articulation of the sound not unlike the articulation produced by human speech.

Notice in all of these sounds that the Envelope Generator DECAY control has no effect because the SUSTAIN control is set at maximum, and therefore may be set anywhere.

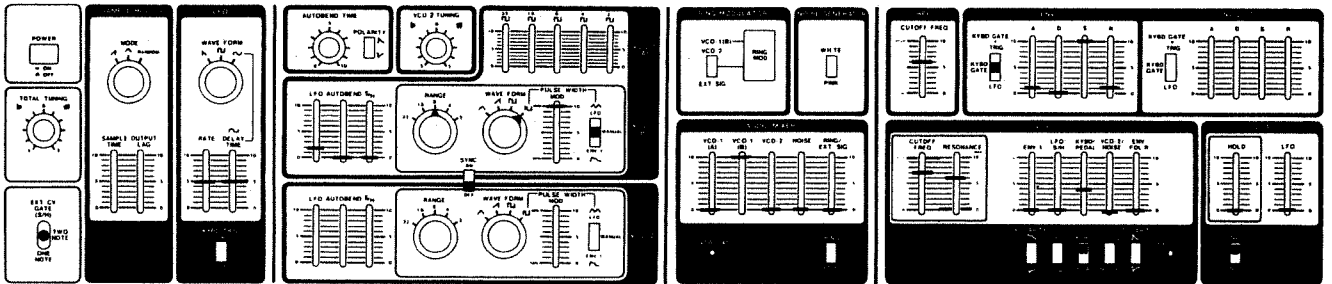

GROUP 2— BRASS INSTRUMENTS

4 TRUMPET

Most brass sounds can be synthesized by starting with the sawtooth wave. The settings of ENV-1 are typical of all brass instruments. The VCF ENV-1 slider can be used to control the tone quality of the trumpet sound. For example, set at "10", the trumpet sound is very bright; but set at about "7" or "8", the trumpet becomes more mellow. Also, try adding delayed vibrato (as shown with the oboe) and autobend.

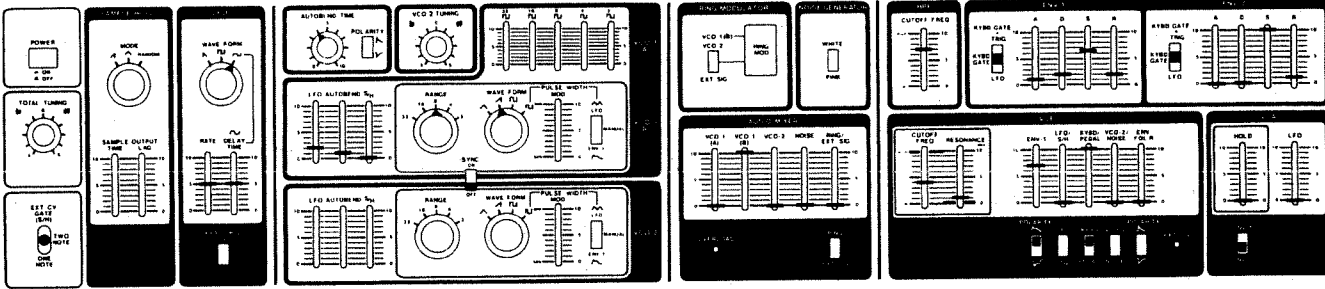

5 HORN

The horn, like the flute, produces a sound which is relatively pure. The main difference, besides pitch range, is the absence of the flute-like growl. As with other brass sounds, the setting of the Envelope Generator controls and the VCF ENV-1 control are important in determining the sound quality of the horn. Try adding portamento to get trombone-like glissandos.

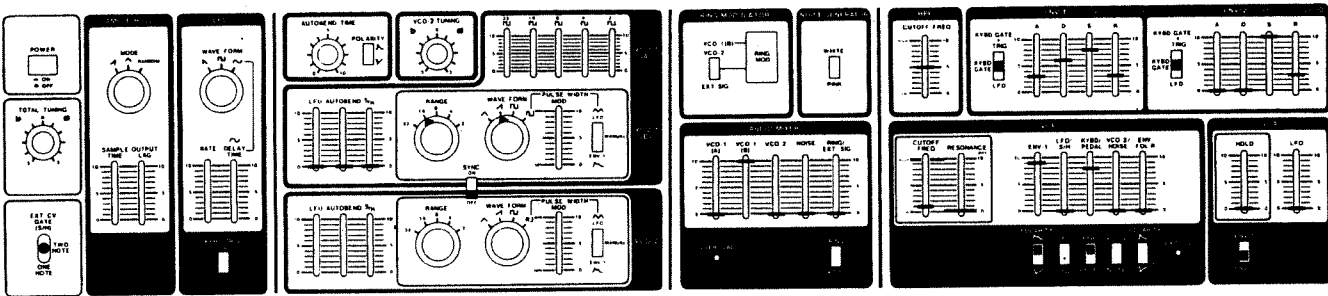

6 TUBA

The tuba uses the 32' sawtooth wave. Also try setting the TRANSPOSE switch to "L" for a very deep tuba. Try adding a little growl with the VCF LFO/S/H control (switch at LFO). Notice that in this, and the other brass sounds, that Envelope Generator 1 is used to control the progression of harmonics in the brass sounds while Envelope Generator 2 is used merely to "open" and "close" the VCA.

This sound is enhanced by using a graphic equalizer or your amplifier tone controls to accent the bass frequencies.

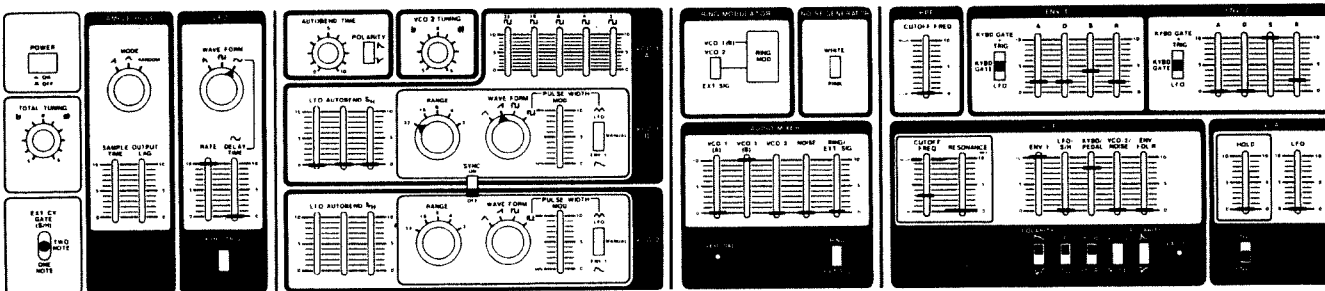

GROUP 3—STRING INSTRUMENTS

7 VIOLIN (BOWED)

The harmonic content of the sawtooth wave very closely matches that of a vibrating string. The higher harmonics are strong, thus the VCF CUTOFF FREQ is set at maximum to pass all the harmonics, and the HPF CUTOFF FREQ control is set at about "5" to help accent these upper harmonics by cutting down the lower frequencies.

The violin represents a case where one of the

smaller details of the sound, vibrato, becomes very important to the overall effect. Try lowering the VCO LFO control and note how artificial the sound becomes. Also try using the vibrato without the DELAY TIME; again, not too natural. Try different combinations of the LFO RATE and DELAY TIME controls, as well as the VCO LFO control to find settings which sound best to you.

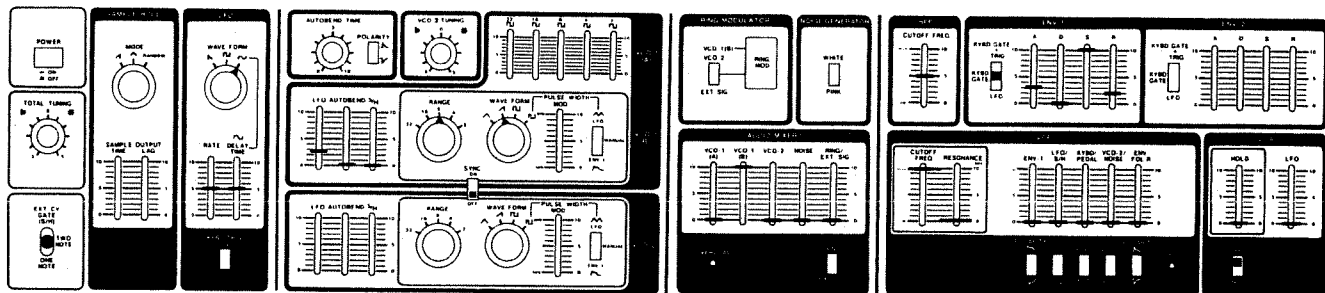

8 FUZZ GUITAR

With plucked string instruments (including the pizzicato violin), the harmonic content of the sound is high at the start of the sound and gradually dies away as the sound dies away. With this type of sound, then, the envelope control of the harmonics becomes important.

In the Fuzz Guitar patch as shown, this tone color variation is obtained by using envelope modulation of the VCO pulse wave output. This

is a very good patch for experimenting with the VCF CUTOFF FREQ and RESONANCE controls. Try the CUTOFF FREQ at LOW and the RESONANCE at about "7" or "8". This kind of sound is typical of synthesizers. As a variation of this, try the VCF CUTOFF FREQ at HIGH and the ENV-1 POLARITY switch at \checkmark . Also, try all of these variations with the VCA envelope selector switch at ENV-2.

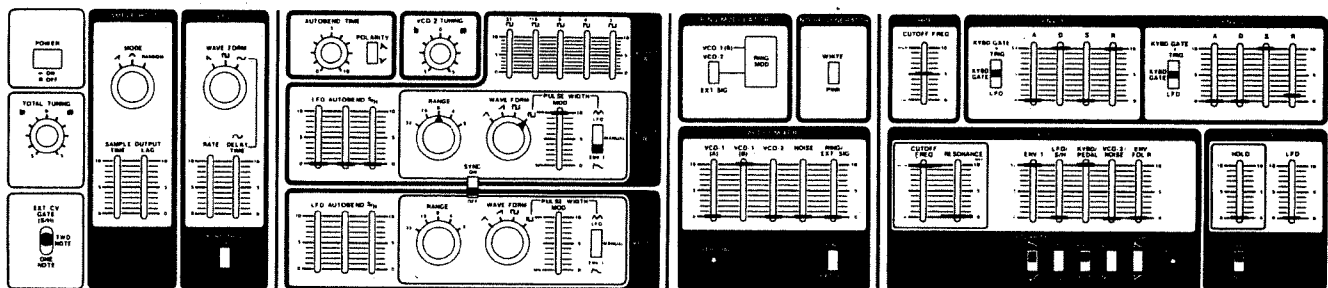

9 BASS GUITAR

The Bass Guitar sound also uses envelope modulation of the VCO pulse waveform. In this case, however, the PULSE WIDTH MOD slider is at "8" so that the change in the pulse wave is a little less than it is for the Fuzz Guitar sound, and the ENV-1 DECAY and RELEASE sliders are at "2" for a faster change.

Try setting the VCF CUTOFF FREQ at other places between "2" and "4" for soft and hard

bass sounds. Also try raising the VCF RESONANCE control a little.

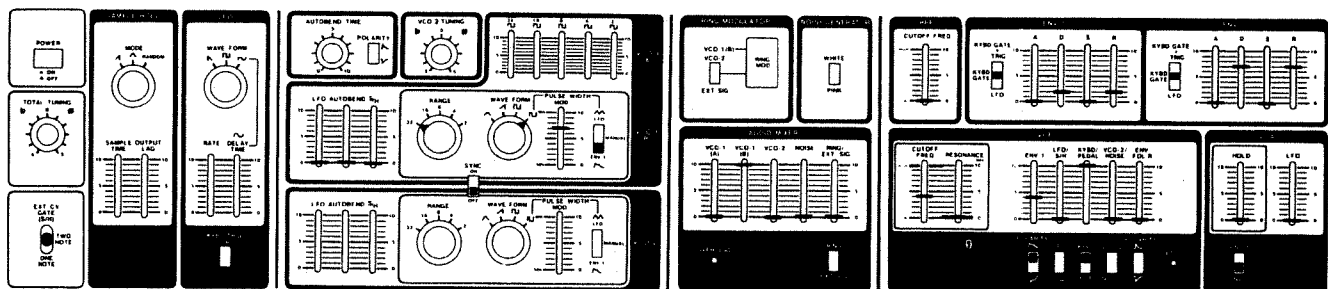

GROUP 4 – PERCUSSION

10 XYLOPHONE

The Xylophone sound uses a 4' square wave as its source. This is an example of a sound which may require a bit of careful adjustment of the VCF CUTOFF FREQ and RESONANCE controls in order to get the sound just right. This is also an example of a sound which can use LFO triggering of the Envelope Generator very effectively.

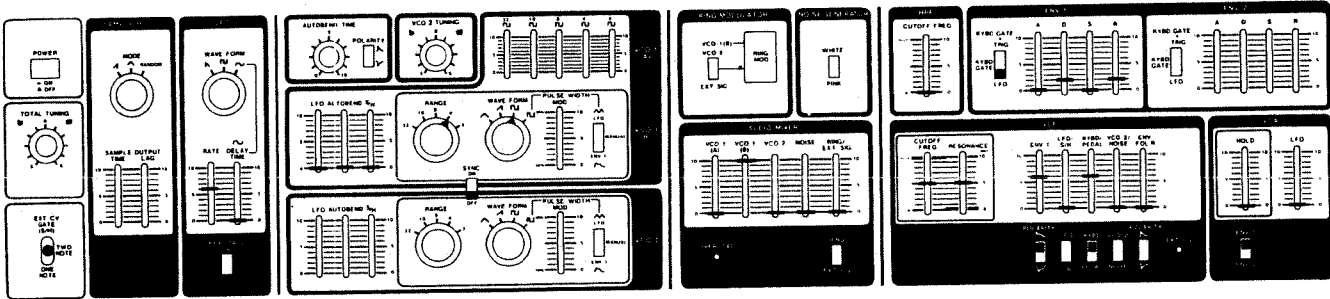

11 VIBRAPHONE

The Vibraphone requires two VCO's, one of them tuned to two octaves above the other. Don't forget to put the VCO SYNC switch to ON and the KEYBOARD MODE switch at ONE NOTE. Try lowering the ENV-1 controls slightly for a softer effect. Also try different LFO RATE settings.

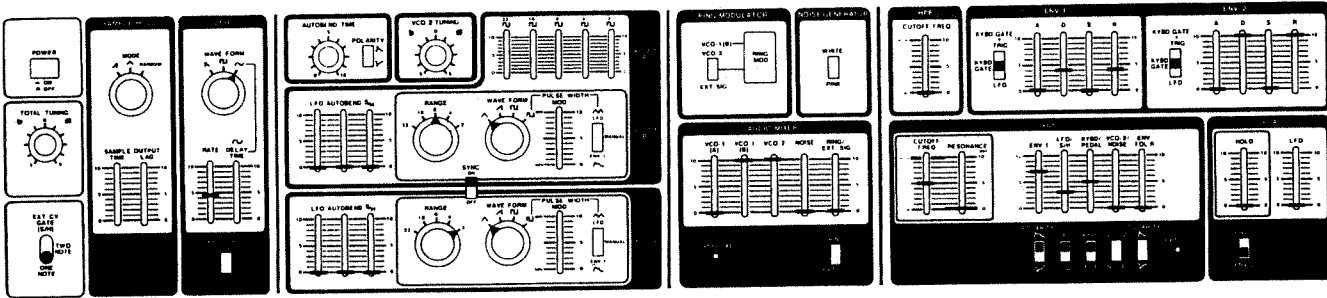

12 SNARE DRUM

The Snare Drum sound uses two sound sources: The Noise Generator to imitate the sound of the snares, and the VCO triangle wave to add the drum pitch to the sound. The mixing levels are important for this sound. The pitch of the drum will depend on which key is depressed. For performance, select the key with the pitch you like and use only that key for a natural snare drum, or play different pitches for a snare drum

only the synthesizer can produce. For fixed pitch, try the C in the middle of the keyboard. As shown, this patch produces a snare drum roll. For some interesting "pop" sounds, lower the Audio Mixer VCO slider to "0", raise the VCF RESONANCE control to about "8", and lower the VCF CUTOFF FREQ to about "5". Also try slightly shorter DECAY and RELEASE times.

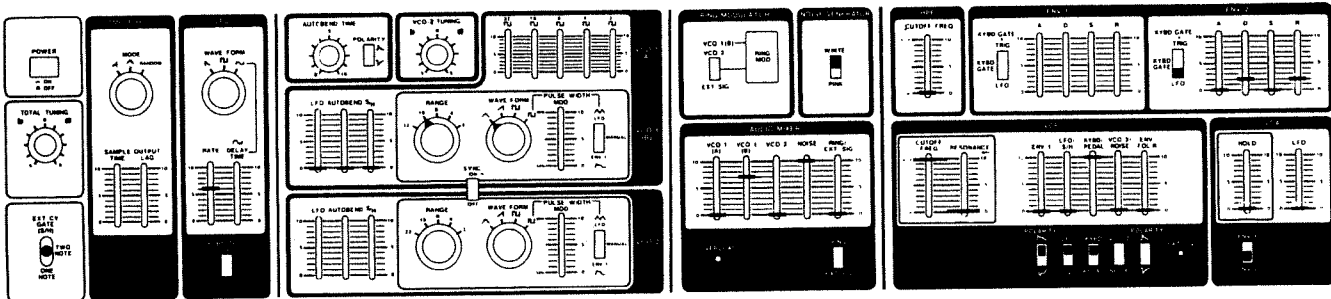

GROUP 5 – KEYBOARD INSTRUMENTS

13 ELECTRIC PIANO

Like the vibraphone sound, the Electric Piano sound uses two VCO triangle waves as the sound source. Again, note that the SYNC switch is ON and the KEYBOARD MODE switch is at ONE NOTE.

key is struck.

Try different balances of the two triangle waveforms, or try with only the B' triangle wave. Note that the LFO KYBD TRIG switch is ON so that the tremolo has the feeling of starting each time a

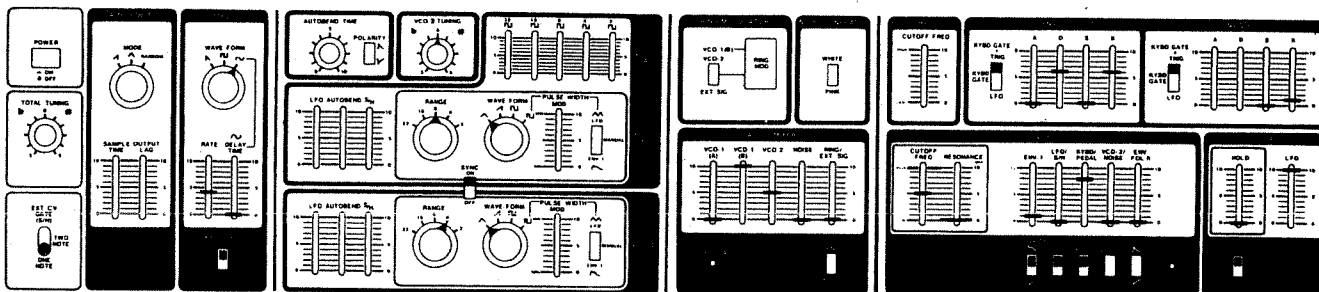

14 HARPSICHORD

The Harpsichord sound is very rich in high harmonics. This effect is produced by using two pulse waves combined and by using the High Pass Filter. Adjust the VCO-2 TUNING control so that the VCO's are very slightly out of tune. Also try modulating one or both pulse waves with ENV-1.

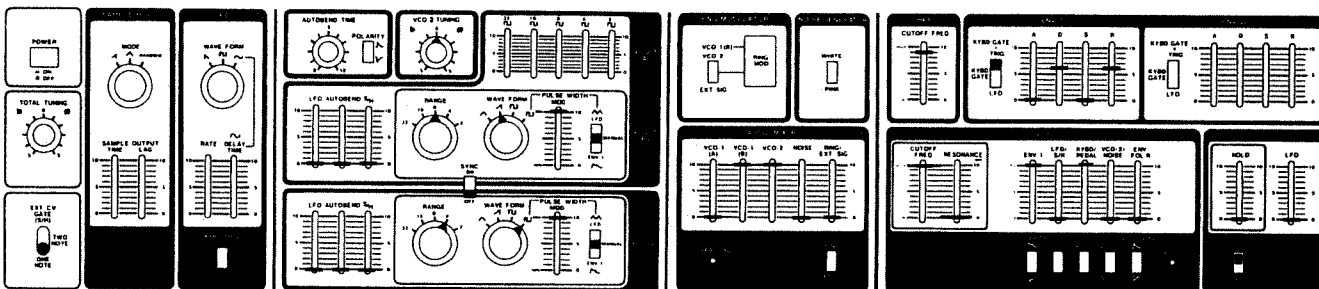

15 ORGAN

It is impossible to play chords, but with this patch you can get solo melody-like sounds, or two note chords. This sound can be varied a great deal by using different combinations of square wave outputs from VCO-1(A), VCO-1(B), and VCO-2.

Generator 1, the lower this control, the stronger the click sound. You will probably have to turn the TOTAL VOLUME control up to compensate.

Key click sound can be produced by setting the VCA envelope selector switch at ENV-2 and lowering the SUSTAIN control of Envelope

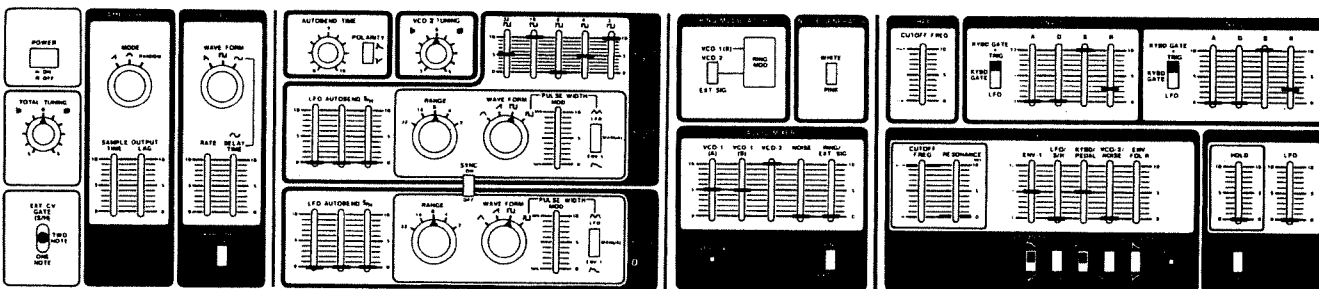

GROUP 6 - OTHER SOUNDS

16 WHISTLE I

This whistling sound is produced with a 4' triangle wave. The two most important features of this sound are the use of the LFO for vibrato and the use of the Autobend function. Try different variations of the LFO RATE and DELAY TIME controls and the depth (VCO LFO slider) of the effect. Also try different variations of the AUTOBEND TIME and VCO AUTOBEND level. And last, try varying the Envelope Genera-

tor ATTACK time a little. These experiments should help you arrive at an excellent whistle sound. For variety, try adding a little portamento.

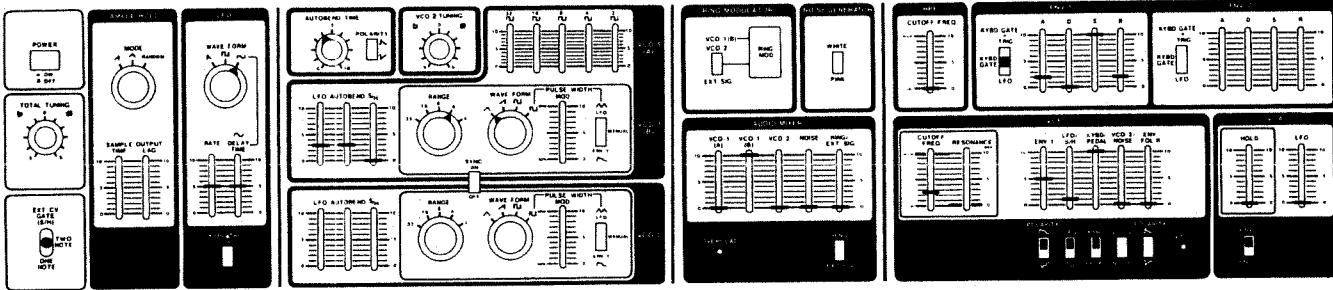

17 WHISTLE II

This sound is actually very much like Whistle I except that the VCF is used as the sound source. Remember that with the VCF RESONANCE control at MAX (10), the VCF oscillates by itself; in other words, it generates sound. The frequency of this sound is controlled by the VCF CUTOFF FREQ control. The other VCF controls also affect the VCF cutoff point,

thus the frequency of the sound. The use of ENV-1 with inverted POLARITY (✓) produces the autobend effect used in Whistle I. The LFO/S/H control (switch at LFO) produces the vibrato effect. Both of these controls should be placed just a little above "0". Also, raising the VCO-2/NOISE control (switch at NOISE) just a hair from "0" produces the affect of breath noise in the whistling.

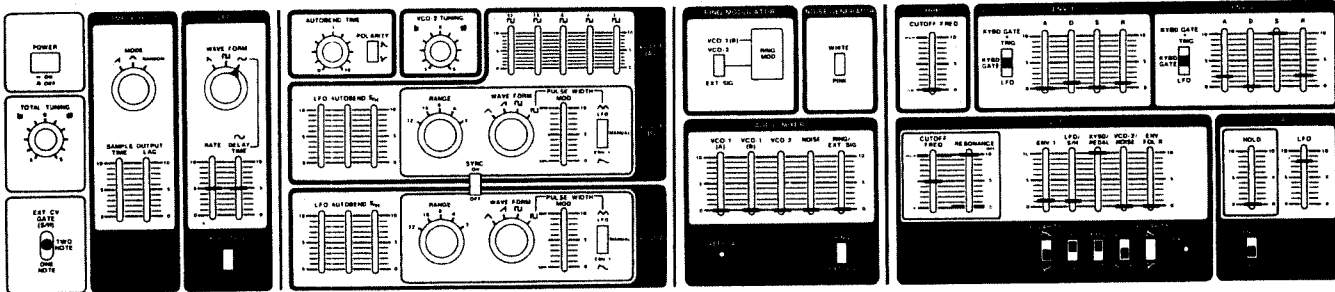

18 BELL

Normally, bell-like sounds are produced using the Ring Modulator. This patch shows how similar bell-like sounds can be produced using the oscillating VCF modulated by the triangle wave from VCO-2. The setting of the VCO-2/NOISE control (switch at VCO-2) and the VCF CUTOFF FREQ control are rather difficult and will require a bit of experimenting to get them exactly right. Also try raising the VCF ENV-1

control (with all Envelope 1 controls at "0", as shown). Also try various settings of the Envelope Generator 1 controls, and try inverting the envelope.

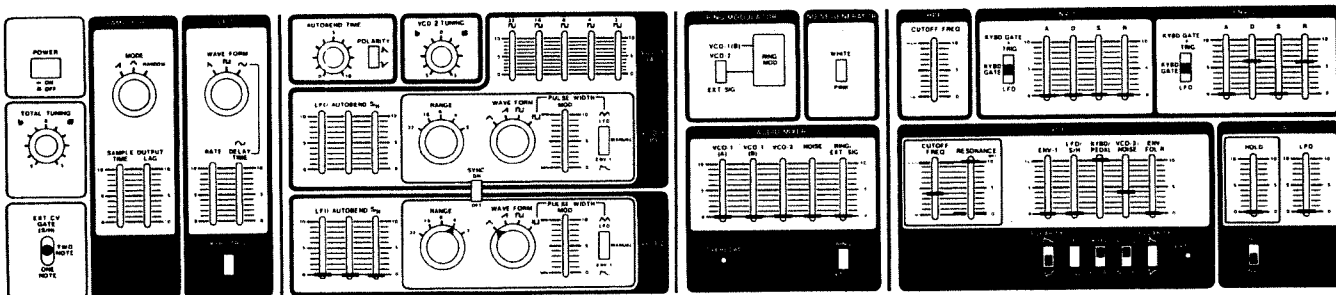

GROUP 7 – SOUND EFFECTS

19 STEAM LOCOMOTIVE

Noise forms the source for the Steam Locomotive sound. The tone quality of the sound can be varied with the VCF CUTOFF FREQ control, and also with the VCF ENV-1 control. The "speed" of the locomotive is controlled by the LFO RATE control. The effect of light and heavy loads can be gotten by varying the Envelope Generator ATTACK time.

Note that the VCF KYBD/PEDAL switch must

be in the KYBD position even though the slider above isn't being used. Remember that since the use of keyboard control voltage control of the VCF cutoff point is quite common, when the switch is in the PEDAL position, keyboard control voltage is internally connected to the VCF. To prevent this, then, the switch should be at KYBD.

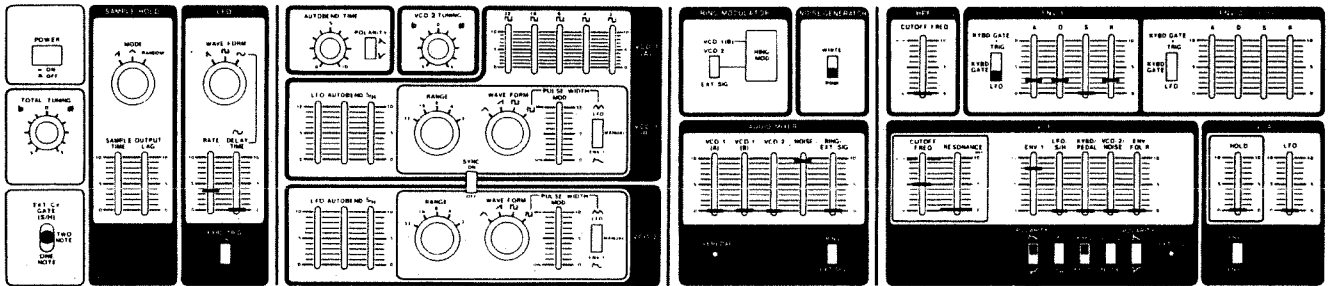

20 WIND

Wind is made from white noise. The VCF CUTOFF FREQ control acts as a tone control for the wind sound, while the RESONANCE control can be used to produce the whistling of the wind. With RESONANCE at about "5", you get an ordinary wind; with RESONANCE at "8" or more, you get storm winds. With the LFO/S/H slider at "0", you can control the "force" of the wind manually with the VCF CUTOFF FREQ control.

This is an excellent example of using the random output of the S/H. Try setting the S/H OUTPUT LAG control at "0" and you can see how the "10" position "softens" the changes of the wind sound. Also try the Wind sound with different S/H SAMPLE TIME rates.

By raising the VCF VCO-2/NOISE control (switch at NOISE) to about "5" or so, it is possible to produce sounds similar to that produced by falling rain.

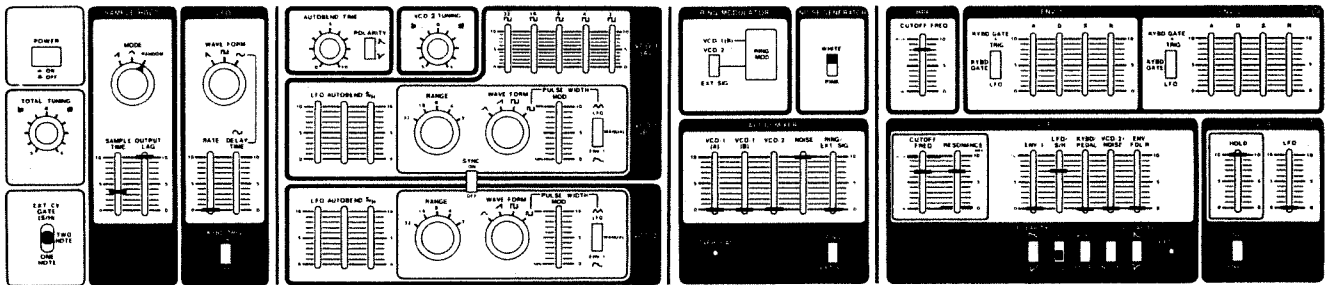

21 GUN SHOTS THUNDER

For gun shots, start with the oscillating VCF (RESONANCE control at "10") as the sound source. Modulate this with pink noise by raising the VCF VCO-2/NOISE control (switch at NOISE) to about "3". Note that with the VCF KYBD/PEDAL control at "10", the tone color of the gun shots will depend on which key on the keyboard is struck. If both Envelope Generators

are triggered by means of the LFO, machine gun shots result.

Cannon shots or thunder can be produced by increasing the Envelope Generator DECAY and RELEASE times. These sounds can be improved by setting the VCF CUTOFF FREQ at LOW and raising the other VCF controls higher.

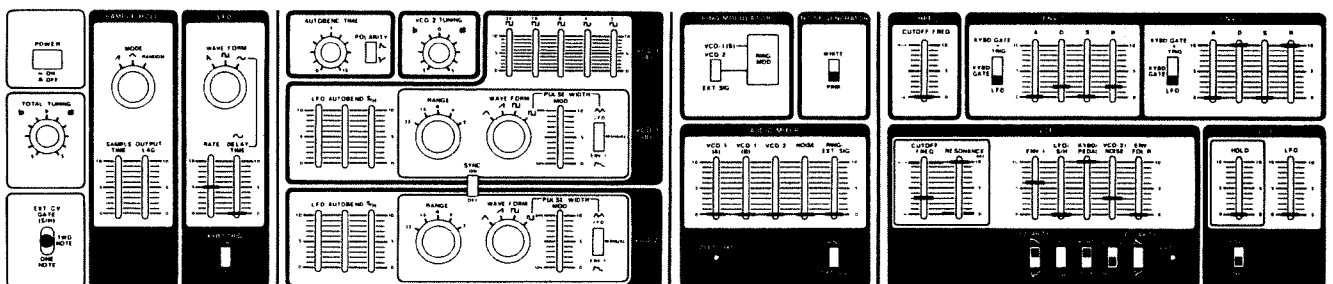

GROUP 8 – USING EXTERNAL SOUND SOURCES

22 ENVELOPE FOLLOWER This patch will produce automatic wah effects on any sound source connected to the EXT SIG INPUT jack on the rear panel. Set the level controls so that the external sound just begins to light the OVERLOAD LED in the Audio Mixer section when the external sound source is at its loudest.

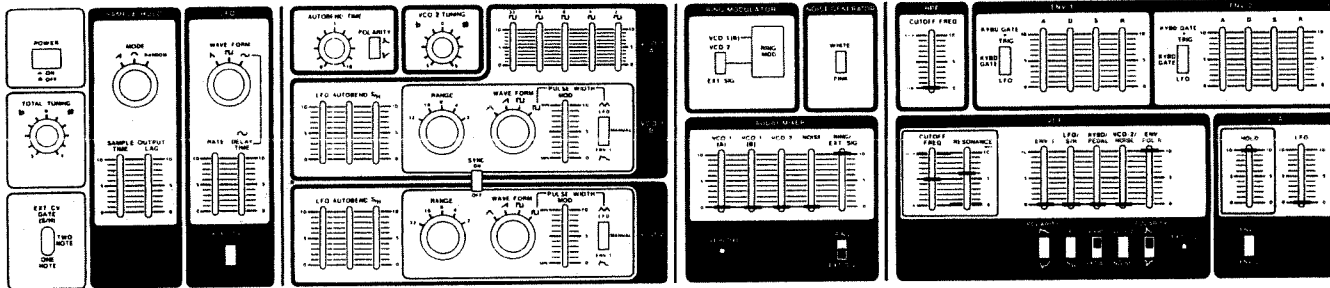

23 ENVELOPE MODIFIER This patch allows the SH-7 to be used for altering the envelope of an external sound source. When using the Roland RS-202 Strings or Roland VK-6 or VK-9 Organs, the gate output of these instruments can be used to trigger the SH-7 Envelope Generators, thus creating polyphonic synthesizer-like sounds.

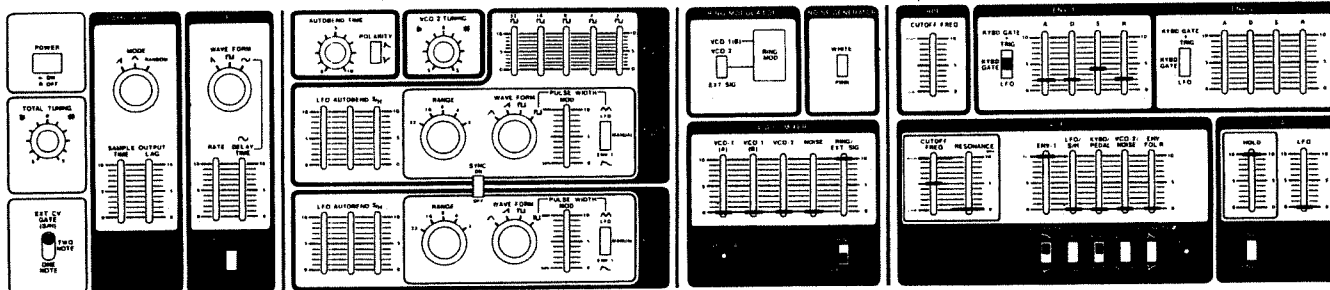

24 RING MODULATOR This patch allows processing of an external sound source by means of the Ring Modulator for producing bell- and gong-like sounds. Good effects are obtained by using external sources with piano-like envelopes such as an electric piano or electric guitar, combined with the triangle wave from VCO-1(B). The sounds can be varied by changing the VCO RANGE control or the VCO pitch by means of the keyboard. Use

the HPF and VCF to remove unwanted harmonics from the sound.

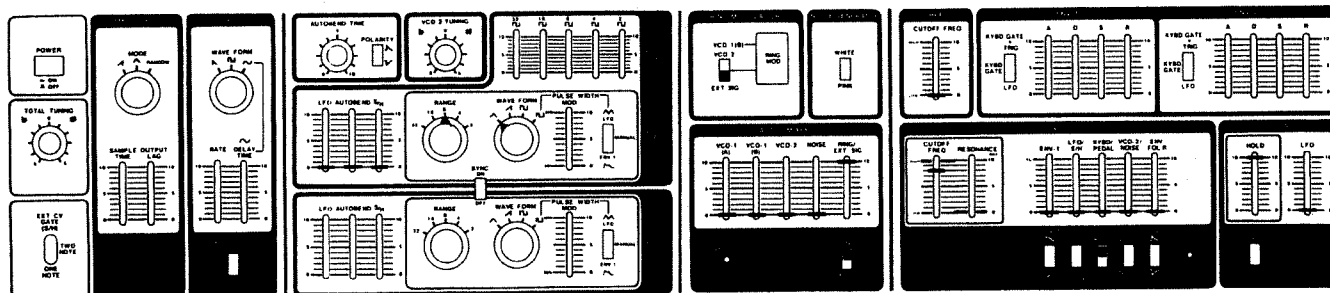

MANEUVERING BENDER

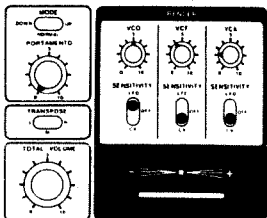
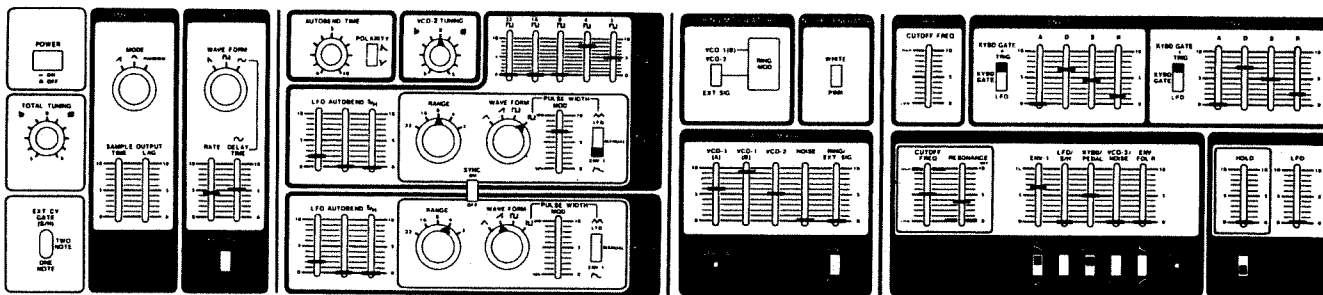

GUITAR-LIKE SOUND

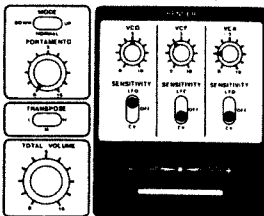
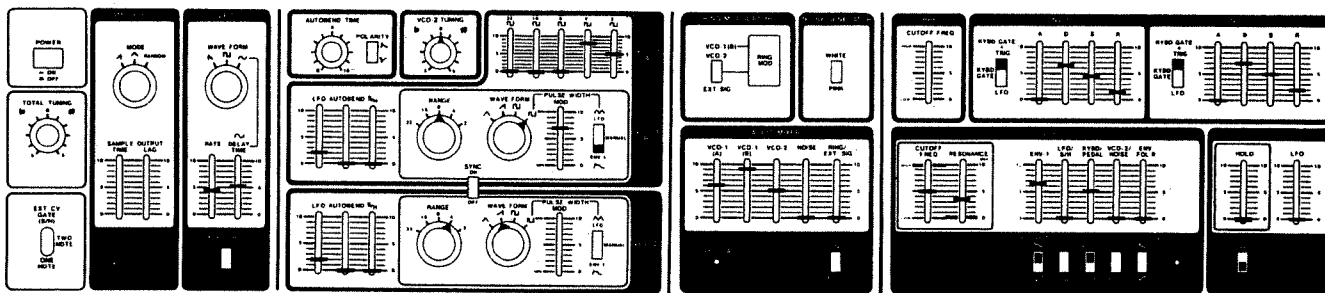
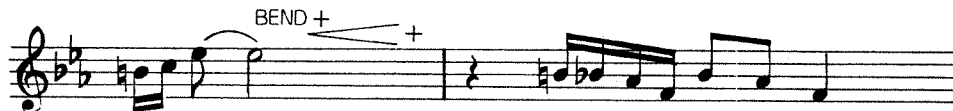

GUITAR-LIKE SOUND



SENSITIVITY CONTROL – Tune VCO's so maximum + bend produces major sound.

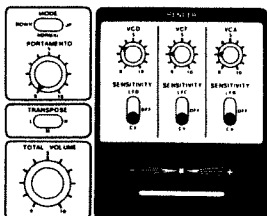
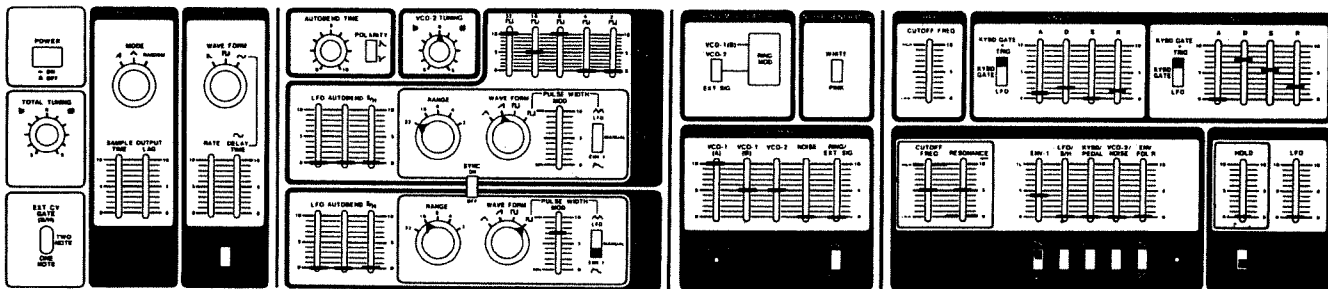

FUNKY BASS

SOUND SYNTHESIS MEMO

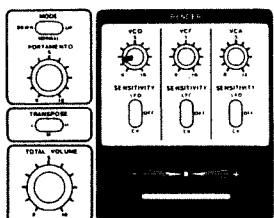
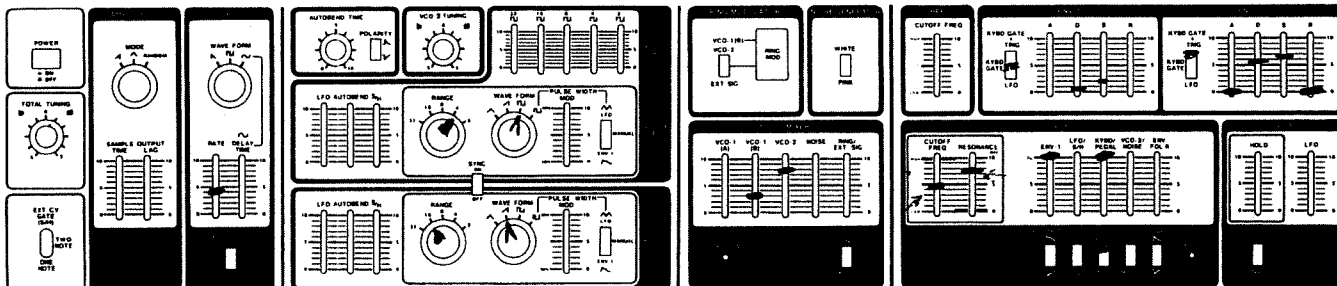
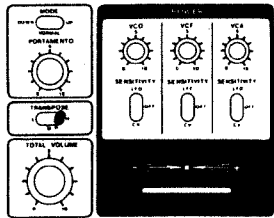
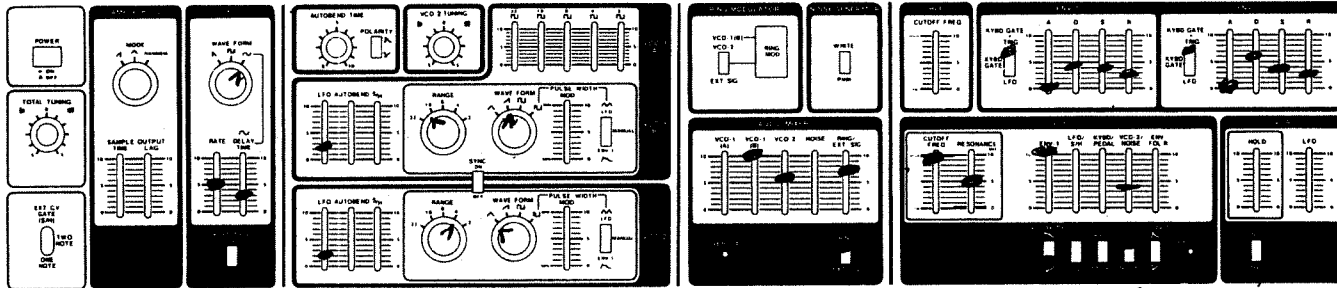
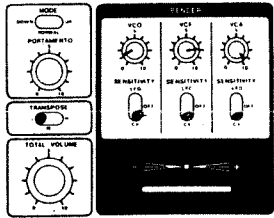
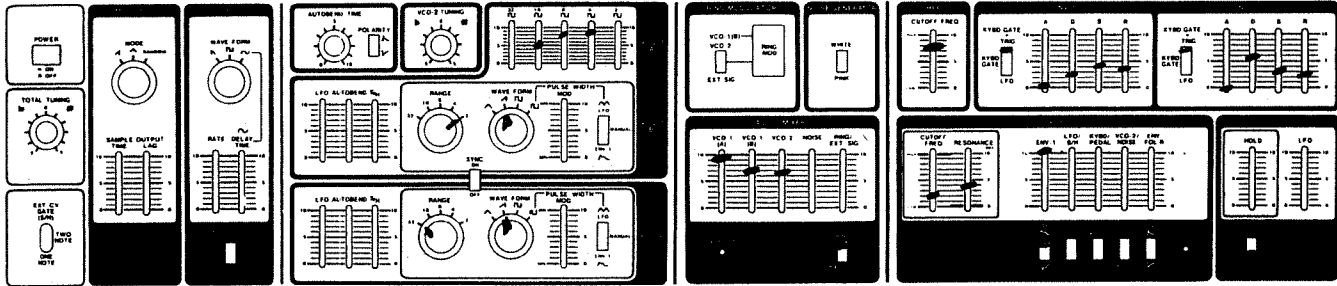

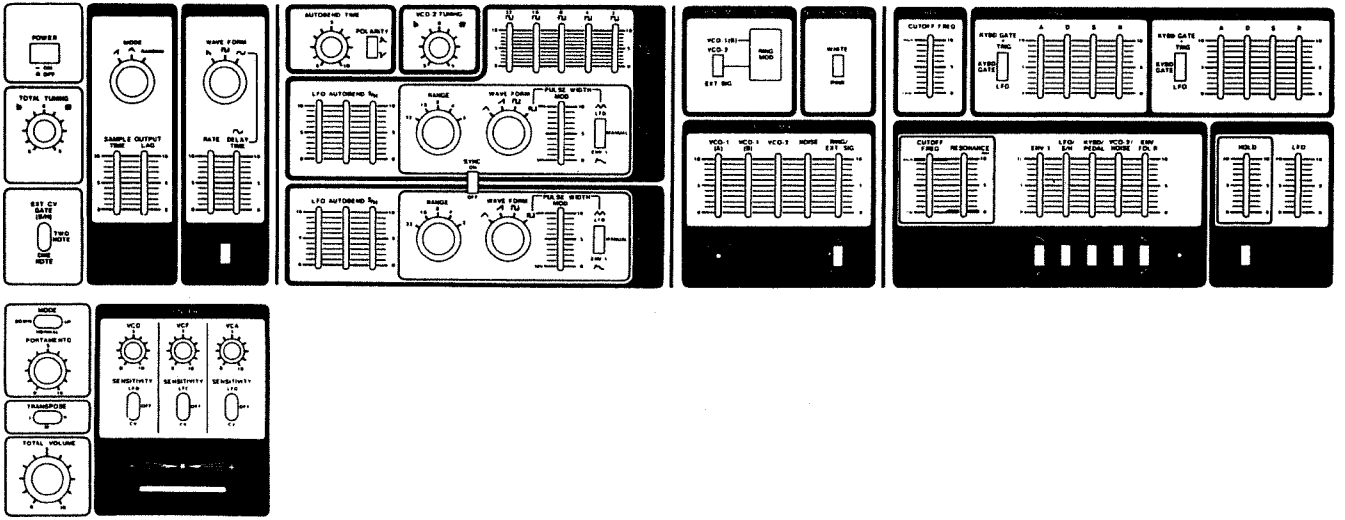
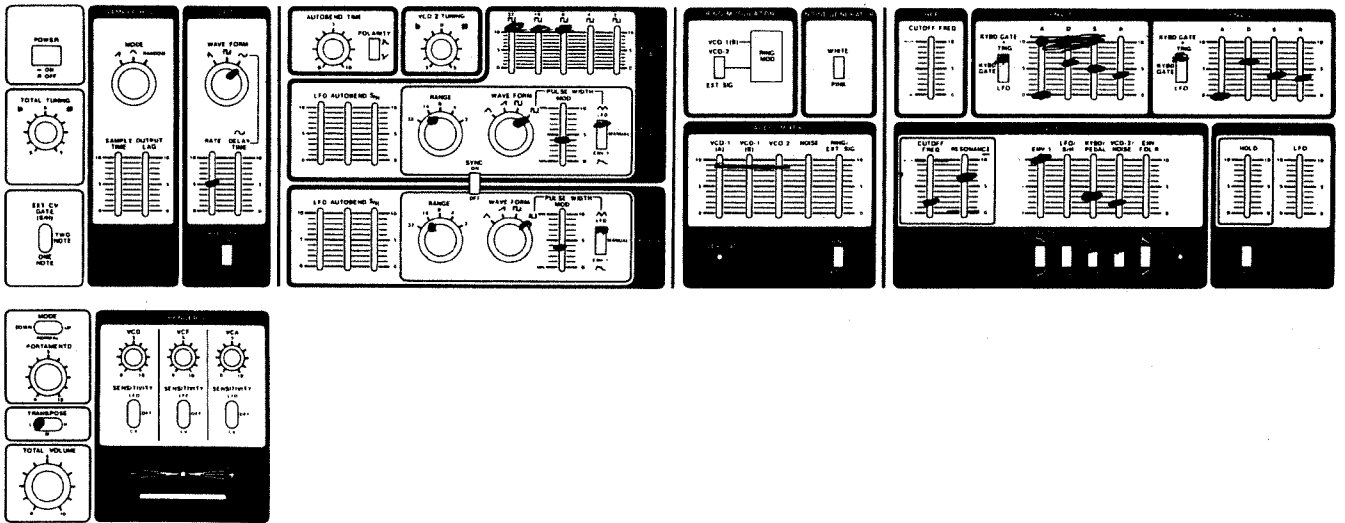
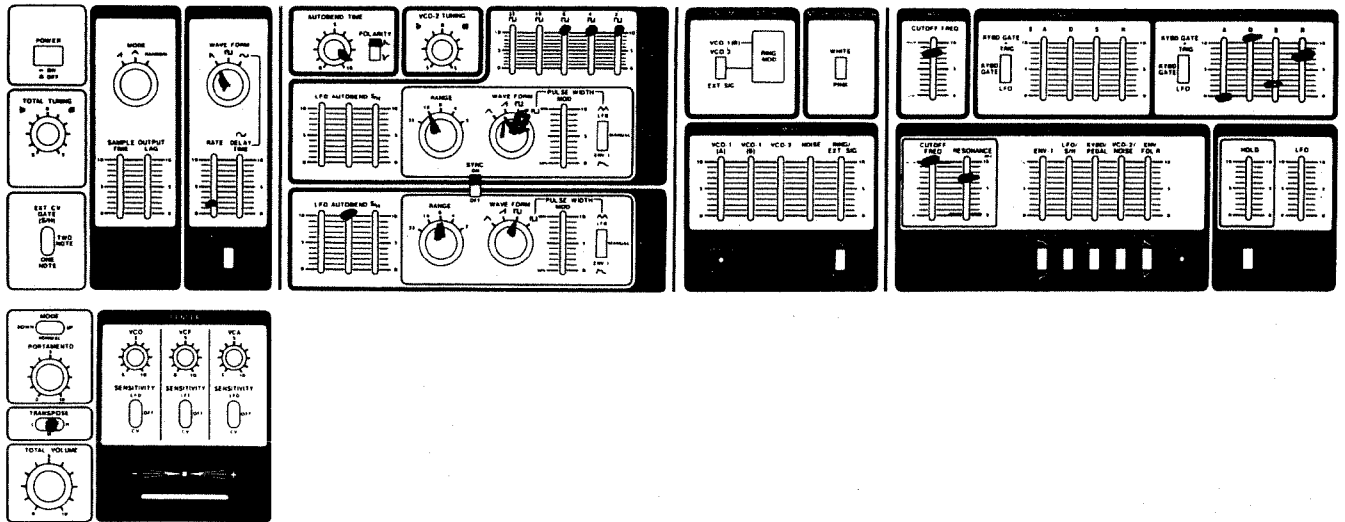

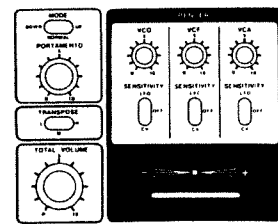
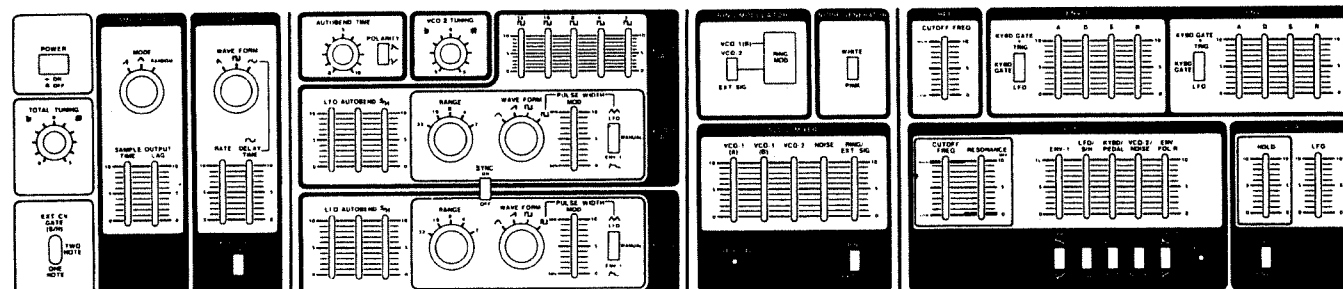
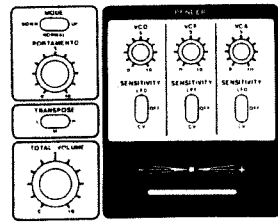
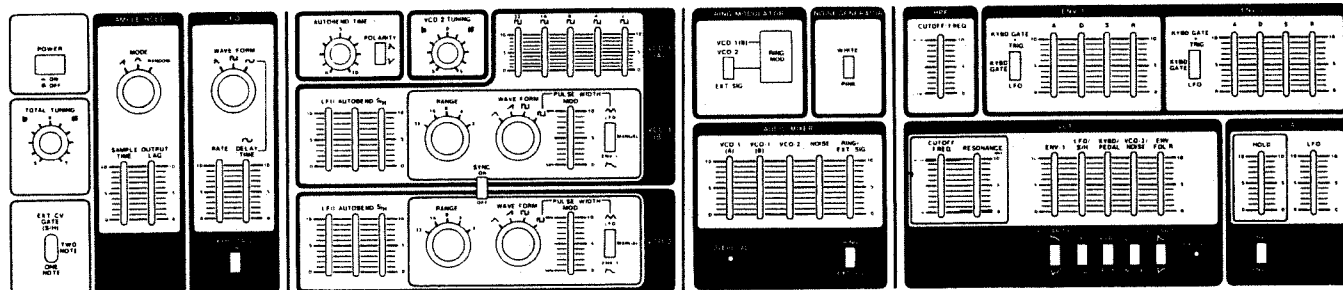
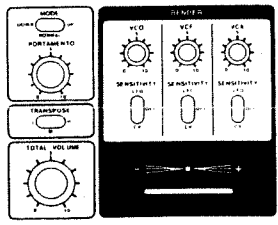
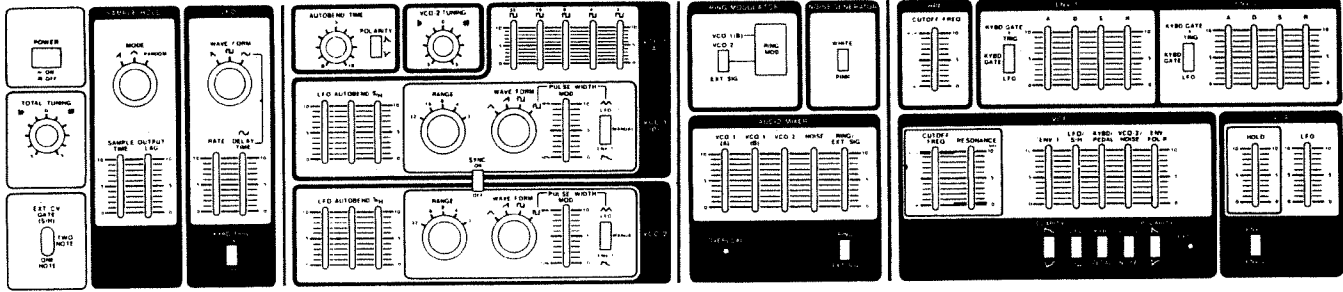

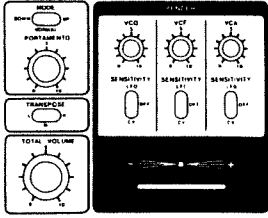
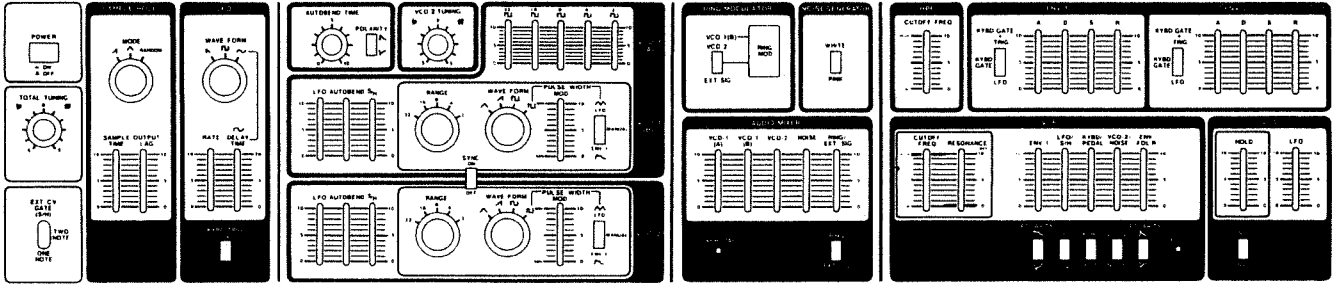
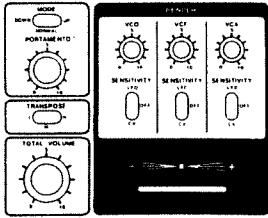
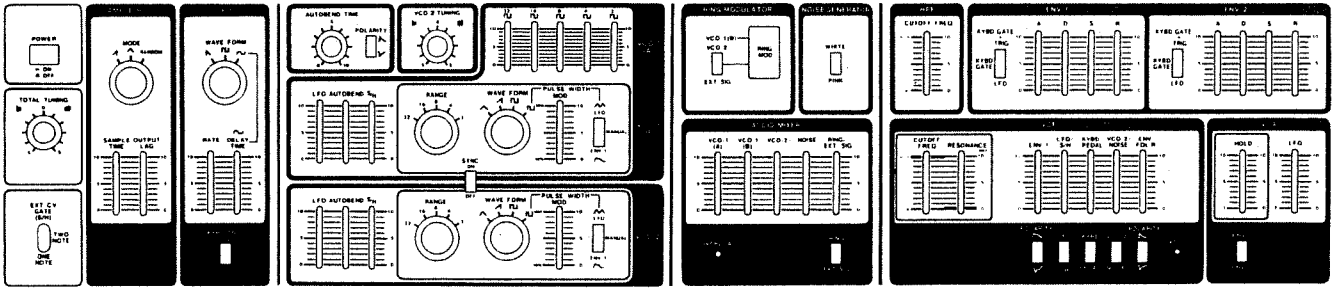
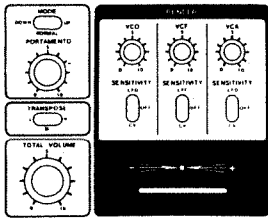
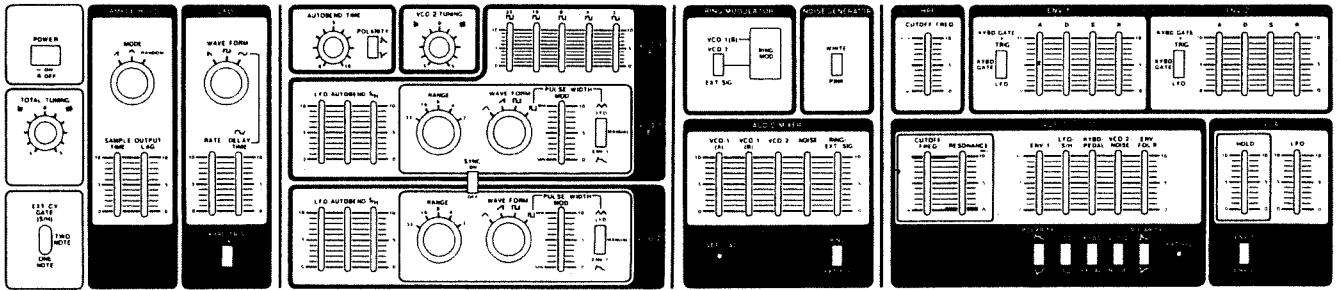



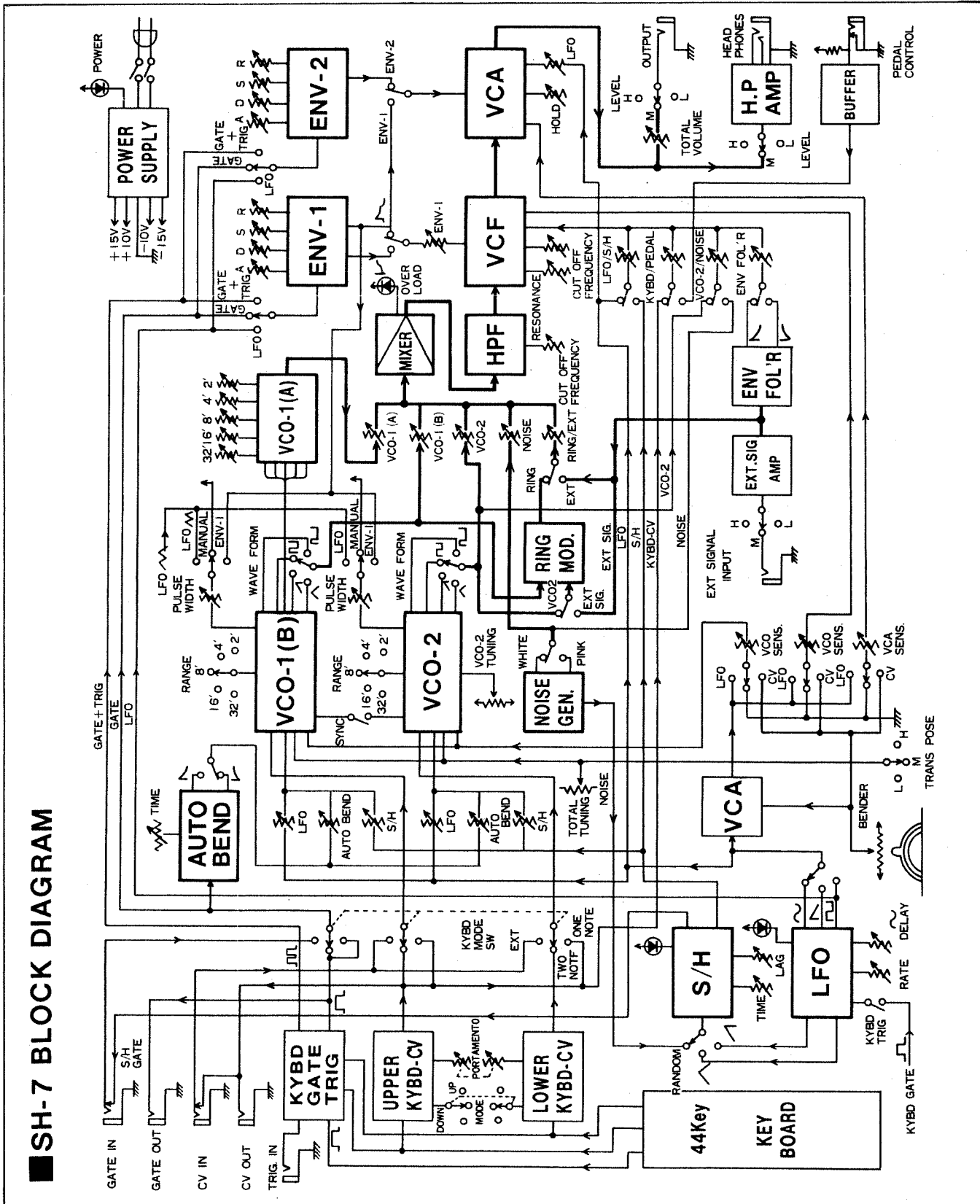









BLOCK DIAGRAM



SPECIFICATIONS

■ KEYBOARD 44 keys, 3-1/2 octaves	■ VCA (Voltage Controlled Amplifier) 1	■ CONNECTION JACKS
■ VCO (voltage controlled oscillator) 2	Hold Control 1	Output Jack
VCO-1(A/B) (upper note of two voice) 1	LFO Control 1	(standard -18dBm/-6dBm/+6dBm) 1
VCO-2 (lower note of two voice) 1	Envelope Switch (ENV-1/ENV-2) 1	Output Level Switch (L/M/H) 1
VCO-1(A) Feet Series Mixing Controls	■ ENVELOPE GENERATOR 2	Phones Jack (8Ω, stereo) 1
32', 16', 8', 4', 2' [] 5	Attack Time Control (max. 4 sec.) 2	Phones Output Level Switch (L/M/H) 1
CONTROLS	Decay Time Control (max. 8 sec.) 2	Pedal Control VCF Jack 1
LFO Modulation 2	Sustain Level (0-100%) 2	External Signal Input Jack
Autobend Depth 2	Release Time (max. 8 sec.) 2	(standard 0dBm/-18dBm/-43dBm) 1
S/H Modulation 2	Gate Trigger Selector Switch	External Signal Input Level Switch
VCO Range (32', 16', 8', 4', 2') 2	(Trig + Gate/Gate/LFO) 2	(L/M/H) 1
Waveform ( ,  , ) 2	■ S/H (Sample/Hold) 1	External Trigger Input Jack 1
Pulsewidth Modulation (Min - 50%) 2	Mode Switch ( ,  , RANDOM) 1	External Control Voltage Input Jack
PWM Mode Switch	Sample Time Control	(1V/1 Oct) 1
(Env-1/Manual/LFO) 2	(13msec. - 2 sec.) 1	External Gate Voltage Input Jack
Sync Switch (ON/OFF) 1	Output Lag Control (0-2 sec.) 1	(ON with +3V or over) 1
■ VCO-2 TUNING (±700 cents) 1	Sampling Rate Indicator 1	Keyboard Control Voltage Output Jack
■ AUTOBEND	■ LFO (Low Frequency Oscillator) 1	(1V/1 Oct) 1
Bend Time (20msec - 700msec) 1	Waveform Switch ( , ) 1	Keyboard Gate Output Jack
Polarity Switch ( / ) 1	Rate Control (0.15Hz-25Hz) 1	(OFF - 0V, ON - 14V) 1
■ AUDIO MIXER 1	Delay Time Control (0-3 sec.) 1	■ OTHERS
VCO-1(A) 1	Keyboard Trigger Switch (ON/OFF) 1	Power Consumption 22W
VCO-1(B) 1	LFO Rate Indicator 1	Dimensions 870(W) x 400(D) x
VCO-2 1	■ CONTROLLER	180(H)mm
Noise Generator 1	Portamento Time Control (0-3 sec.) 1	34.3(W) x 15.6(D) x
Ring Modulator/Ext Signal	Portamento Mode Switch	7.1(H)in
(with Ring/Ext Sig selector)	(Down/Normal/Up) 1	Weight 15.5kg, 34 lbs
Overload Indicator 1	Transpose Switch (L/M/H) 1	Accessory 2.5m connection cord
■ NOISE GENERATOR 1	Total Volume 1	• Specifications are subject to change without
White/Pink Selector 1	Bender Lever 1	notice.
■ RING MODULATOR 1	Bender Sensitivity (VCO, VCF, VCA) 3	
VCO-1(B) x VCO-2/Ext Sig	Control Mode Switch (CV, OFF, LFO) 3	
VCO-2/Ext Sig Switch 1	■ TOTAL TUNING (±300 cents) 1	
■ HIGH PASS FILTER 1	■ KEY MODE SWITCH	
Cutoff Frequency Control	(One Note/Two Note/Ext	
(10Hz-10KHz) 1	CV-Gate-S/H) 1	
■ VCF (Voltage Controlled Filter) 1		
Cutoff Frequency Control (5Hz-20KHz) 1		
Resonance (Min - Self Oscillation) 1		
ENV-1 Control Depth 1		
ENV-1 Polarity Switch ( / ) 1		
LFO/(S&H) Control 1		
LFO/(S&H) Switch 1		
KYBD/Pedal Control 1		
KYBD/Pedal Switch 1		
VCO-2/Noise Control 1		
VCO-2/Noise Switch 1		
Envelope Follower Control 1		
Envelope Follower Polarity Switch 1		
External Signal Input Indicator 1		

 Roland®

10247

UPC 10247



10981

Roland Corporation