

 Roland

---

**MIDI** ROLAND DIGITAL PIANO

---

# RD-200/300

---

Owner's Manual

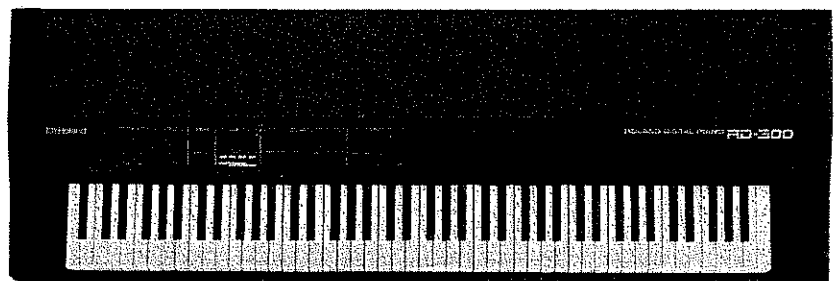
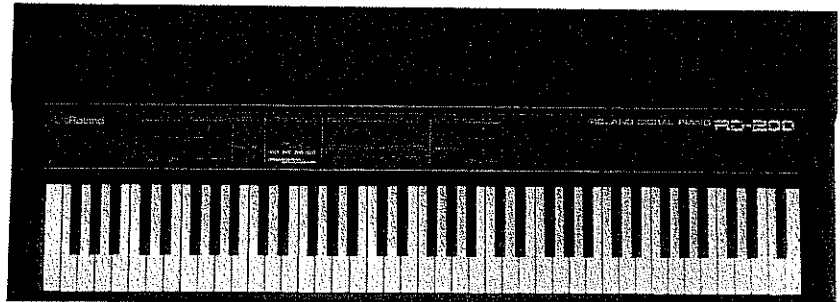

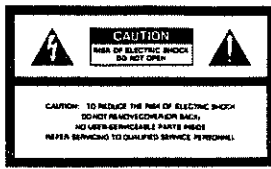

The lightning flash with arrowhead symbol, within an equilateral triangle, is intended to alert the user to the presence of un-insulated "dangerous voltage" within the product's enclosure that may be of sufficient magnitude to constitute a risk of electric shock to persons.

The exclamation point within an equilateral triangle is intended to alert the user to the presence of important operating and maintenance (servicing) instructions in the literature accompanying the product.

INSTRUCTIONS PERTAINING TO A RISK OF FIRE, ELECTRIC SHOCK OR INJURY TO PERSONS.

# IMPORTANT SAFETY INSTRUCTIONS

**WARNING** When using electric products, basic precautions should always be followed, including the following:

1. Read all the instructions before using the product.
2. To reduce the risk of injury, close supervision is necessary when a product is used near children.
3. Do not use this product near water- for example, near a bathtub, washbowl, kitchen sink, in a wet basement, or near a swimming pool, or the like.
4. This product should be used only with a cart or stand that is recommended by the manufacture.
5. This product, either alone or in combination with an amplifier and headphones or speakers, may be capable of producing sound levels that could cause permanent hearing loss.  
Do not operate for a long period of time at a high volume level or at level that is uncomfortable. If you experience any hearing loss or ringing in the ears, you should consult an audiologist.
6. The product should be located so that its location or position does not interfere with its proper ventilation.
7. The product should be located away from heat sources such as radiators, heat registers or other products that produce heat.
8. The product should avoid using in where it may be effected by dust.
9. The product should be connected to a power supply only of the type described in the operating instructions or as marked on the product.
10. The power-supply cord of the product should be unplugged from the outlet when left unused for a long time.
11. Do not tread on the power-supply cord.
12. Do not pull the cord but hold the plug when unplugging.
13. When setting up with any other instruments, the procedure should be followed in accordance with instruction manual.
14. Care should be taken so that objects do not fall and liquids are not spilled into the enclosure through openings.
15. The product should be serviced by qualified service personnel when:
  - A: The power-supply cord or the plug has been damaged; or
  - B: Objects have fallen, or liquid has been spilled into the product; or
  - C: The product has been exposed to rain; or
  - D: The product does not appear to operate normally or exhibits a marked change in performance; or
  - E: The product has been dropped, or the enclosure damaged.
16. Do not attempt to service the product beyond that described in the user-maintenance instructions. All other servicing should be referred to qualified service personnel.

## SAVE THESE INSTRUCTIONS

### WARNING : THIS APPARATUS MUST BE EARTHED

**IMPORTANT** :The wires in this mains lead are coloured in accordance with the following code:  
 Green-and-yellow : Earth  
 Blue : Neutral  
 Brown : Live

As the colours of the wires in the mains lead of this apparatus may not correspond with the coloured markings identifying the terminals in your plug, proceed as follows:  
 The wire which is coloured green-and-yellow must be connected to the terminal in the plug which is marked by the letter E or by the safety earth symbol  or coloured green or green-and-yellow.  
 The wire which is coloured blue must be connected to the terminal which is marked with the letter N or coloured black.  
 The wire which is coloured brown must be connected to the terminal which is marked with the letter L or coloured red.

#### Bescheinigung des Herstellers /Importeurs

Hiermit wird bescheinigt, daß der/die/das

**ROLAND DIGITAL PIANO RD-200/300**

(Gerät, Typ, Bezeichnung)

in Übereinstimmung mit den Bestimmungen der

**Amtsbl. Vfg 1046 / 1984**

(Anbietererklärung)

funk-entstört ist.

Der Deutschen Bundespost wurde das Inverkehrbringen dieses Gerätes angezeigt und die Berechtigung zur Überprüfung der Serie auf Einhaltung der Bestimmungen eingeräumt.

**Roland Corporation Osaka / Japan**

Name des Herstellers/Importeurs

#### RADIO AND TELEVISION INTERFERENCE

**Warning** This equipment has been verified to comply with the limits for a Class B computing device, pursuant to Subpart J, of Part 15, of FCC rules. Operation with non certified or non verified equipment is likely to result in interference to radio and TV reception.

The equipment described in this manual generates and uses radio frequency energy. If it is not installed and used properly, that is, in strict accordance with our instructions, it may cause interference with radio and television reception.

This equipment has been tested and found to comply with the limits for a Class B computing device in accordance with the specifications in Subpart J, of Part 15, of FCC Rules. These limits are designed to provide reasonable protection against such interference in a residential installation. However, there is no guarantee that interference will not occur in a particular installation. If the equipment does cause interference to radio or television reception, which can be determined by turning the equipment on and off, the user is encouraged to try to correct the interference by the following measures:

- Disconnect other devices and their input/output cables one at a time. If the interference stops, it is caused by either the device or its I/O cable.
  - These devices usually require Roland designated shielded I/O cables. For Roland devices, you can return the proper shielded cable from your dealer. For non-Roland devices, contact the manufacturer or dealer for assistance.
  - If your equipment does cause interference to radio or television reception, you can try to correct the interference by using one or more of the following measures:
    - Turn the TV or radio antenna until the interference stops.
    - Move the equipment to one side or the other of the TV or radio.
    - Move the equipment farther away from the TV or radio.
    - Plug the equipment into an outlet that is on a different circuit than the TV or radio. (That is, make certain the equipment and the radio or television set are on circuits controlled by different circuit breakers or fuses.)
    - Consider installing a rooftop television antenna with coaxial cable lead in between the antenna and TV.
- If necessary, you should consult your dealer or an experienced radio/television technician for additional suggestions. You may find helpful the following booklet prepared by the Federal Communications Commission: "How to Identify and Resolve Radio-TV Interference Problems". This booklet is available from the U.S. Government Printing Office, Washington, D.C. 20402, Stock No. D04 000 00345 4.

Please read the separate volume "MIDI", before reading this owner's manual.

Copyright © 1986 by ROLAND CORPORATION

All rights reserved. No part of this publication may be reproduced in any form without the written permission of ROLAND CORPORATION.

## ■ PANEL DESCRIPTION

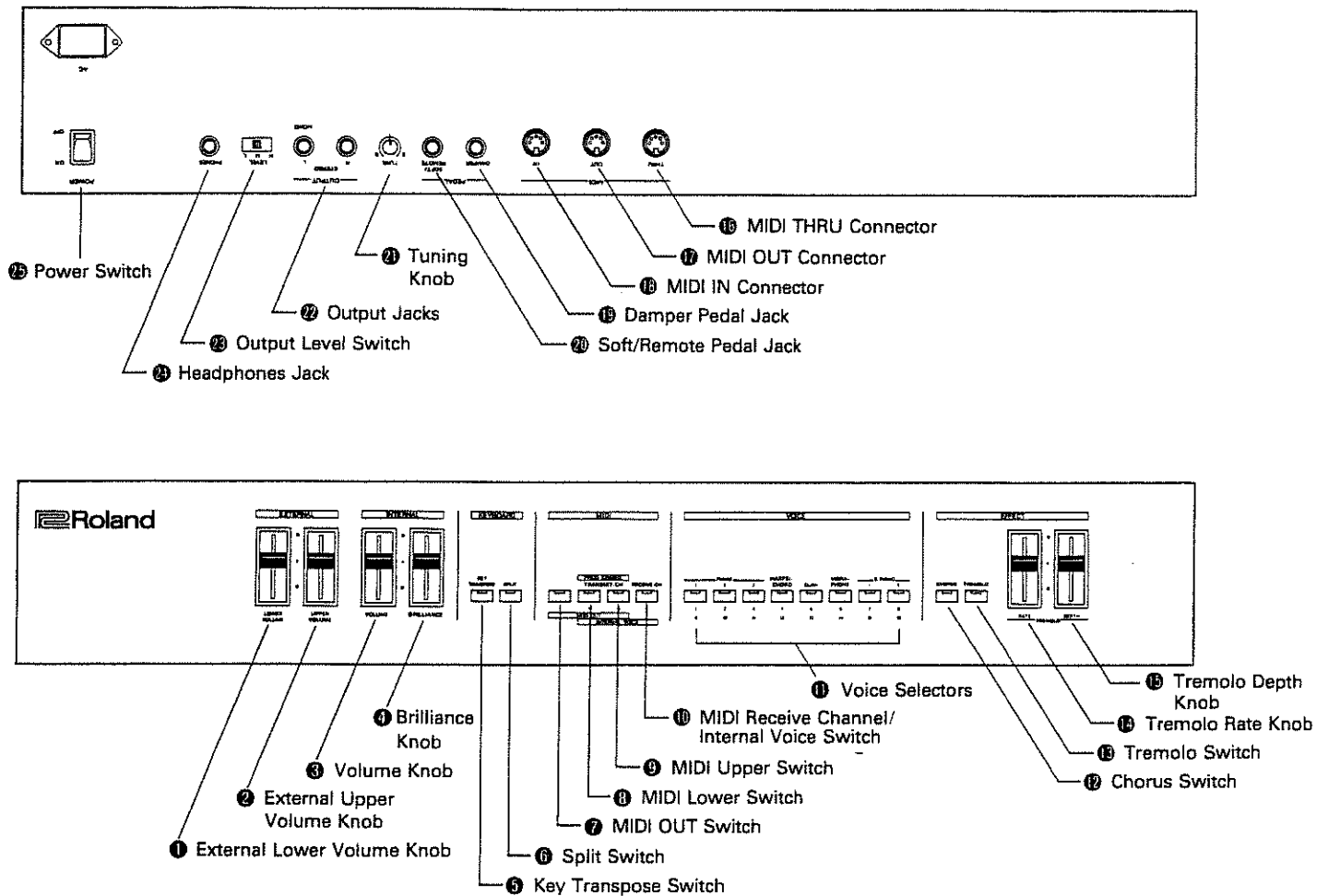

## IMPORTANT NOTES

### Power Supply

- The appropriate voltage to be used is shown on the name plate on the rear panel. Be sure that it meets the voltage system in your country.
- Do not use the same socket that is used for any noise generating device, such as motor, or variable lighting system.
- This unit might not work properly if the power cable is plugged in with the unit turned on. If this happens, simply turn the unit off, and turn it on again in few seconds.
- It is normal for the unit to be warm while operating.

### Power Cord

- When disconnecting the power cord from the socket, do not hold the cord but the plug. When the unit is not to be used for a long period, disconnect the power cord.

### Location

- Avoid using the RD-200 and RD-300 in extreme heat or humidity or where it may be affected by dust, direct sunlight or vibration.

### Cleaning

- Use a soft cloth and clean only with a mild detergent.
- Do not use solvents such as paint thinner.

## ■ CONNECTIONS

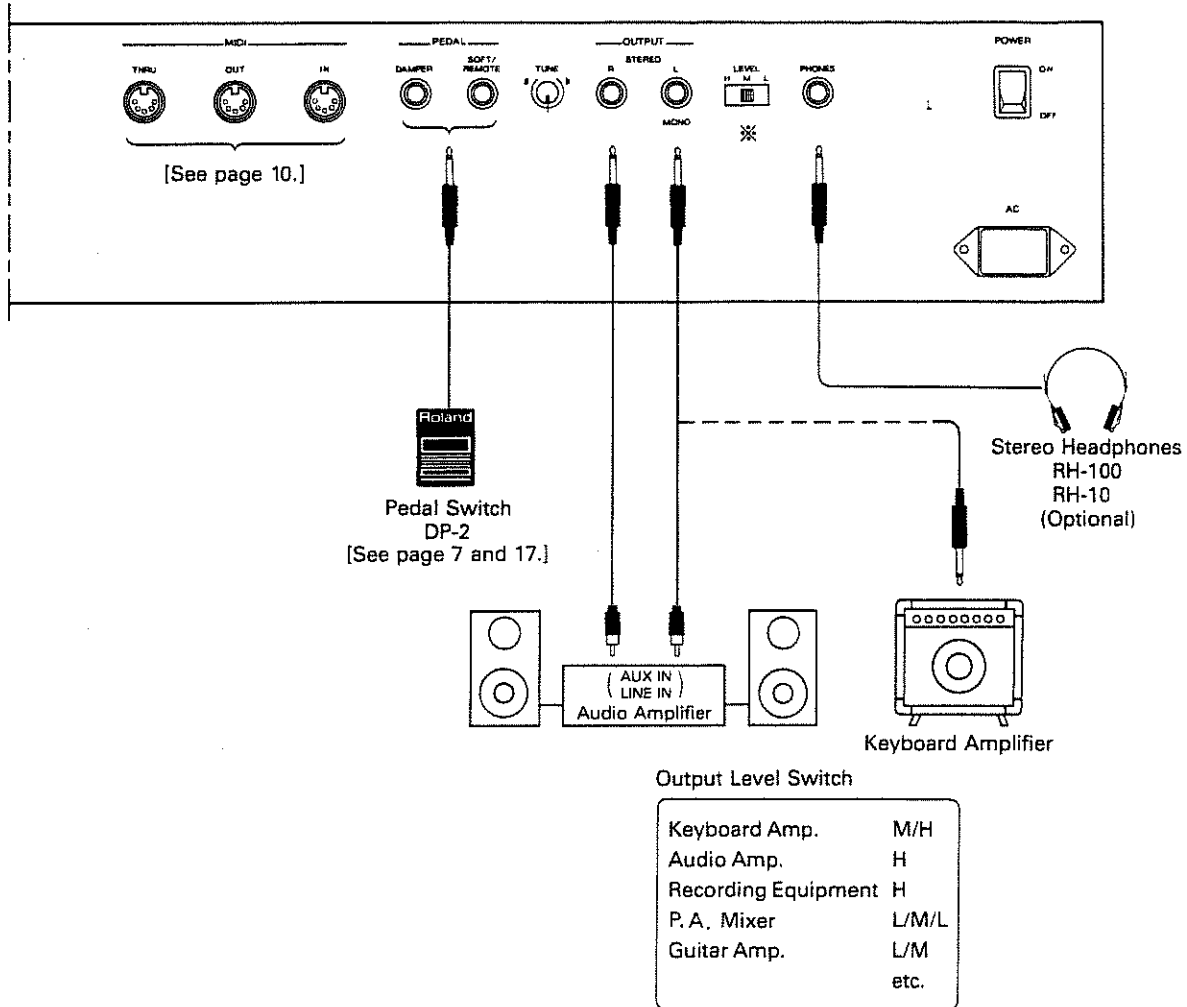

## ■ HOW TO SET UP THE PIANO

1. Connect the supplied power cord to the Receptacle on the rear panel.
2. Connect the plug to the wall socket.

\* Be sure to take the step 1 then 2. Do not do it the other way round.

Roland has developed a new type of digital synthesis technology -- Structured Adaptive (SA) Sound Synthesis. SA Sound Synthesis employs a technique which neither approximates nor simulates acoustic sounds, but actually recreates these sounds. Note for note, nuance for nuance, harmonic characteristics and timbre variations are faithfully replicated across the entire range of the keyboard. Sounds respond to playing dynamics with extraordinary accuracy and warmth. SA Sound Synthesis far surpasses sampling technology in its ability to reproduce and articulate astoundingly realistic acoustic sounds.

## FEATURES

- The Roland RD-200 and RD-300 MIDI Digital Pianos feature 8 studio quality keyboards created by SA Sound Synthesis.
- The RD-200 and RD-300 include built-in Chorus and Tremolo effects.
- The RD-200 and RD-300 can be used as excellent MIDI Keyboard Controllers or as MIDI Sound Modules.

## CONTENTS

■ Panel Description .....	3
■ Connections .....	4
■ Operation .....	6
1 RD-200 or RD-300 as a piano .....	6
a. Tone Selection .....	6
b. Tuning .....	7
c. Damper/Soft Pedal .....	7
d. Brilliance .....	8
e. Chorus/Tremolo .....	8
f. Key Transpose .....	9
2 RD-200 or RD-300 as a MIDI Device .....	10
1. RD-200 or RD-300 as a MIDI Keyboard Controller .....	10
a. Setting MIDI Channels .....	11
b. Setting Split Point .....	12
c. MIDI OUT (ON/OFF) .....	13
d. Internal Voice (ON/OFF) .....	13
e. Transmitting MIDI Messages .....	14
2. RD-200 or RD-300 as a MIDI Sound Module .....	15
a. Setting MIDI Receive Channels .....	15
b. Receiving MIDI Messages .....	15
3. MIDI Functions .....	16
■ Other Functions .....	17
■ Sound Range Diagram .....	18
■ Setting Memo .....	19
■ Specifications .....	21

# 1 RD-200 or RD-300 as a Piano

① Turn the piano on.

The indicator of Piano 1 lights up.

\* For about 2 seconds after turned on, the piano cannot be played because of the muting circuit.

② Adjust the volume with the Volume Knob .

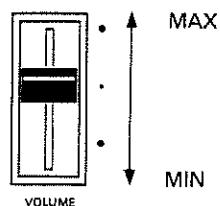

## a. Voice Selection

The RD-200 and RD-300 feature 8 keyboard sounds; two acoustic grand pianos, electric grand piano, harpsichord, clavi, vibraphone and two electric pianos. To select one of these voices, press one of the Tone Selector buttons numbered 1 through 8. One keyboard sound can be selected at a time.

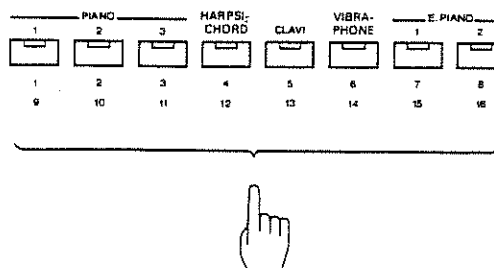

## VOICE PRESERVE FUNCTION

The RD-200 and RD-300 feature the Voice Preserve Function, that is, while you are playing the keyboard using a certain tone color, you can request the next tone color to be used, without the tone actually changing until you release all the keys.

When the piano is being played with the Note or Damper ON, the tone color does not change. (the indicator of the corresponding sound flashes.) To change the voices, lift all Notes and the Damper OFF. (Now, the indicator of the new voice is constantly lighted.)

This Voice Preserve function applies to the external Program Change received by the RD-200 or RD-300.

## b. Tuning

The Tune Knob ② is provided for controlling the overall tuning center of the RD-200 or RD-300. This is especially useful for tuning to other acoustic instruments, synthesizers, and synthesizer sound modules. Since the RD-200 and RD-300 incorporate S/A Synthesis, the tuning of individual notes will never be necessary. At its center position:

Middle A = 442Hz, and the variable range is  $\pm 15$  cents.

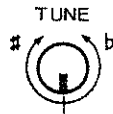

## c. Damper/Soft Pedal

The Damper Pedal Jack ⑬ and Soft Pedal Jack ⑭ are provided to connect to the DP-2. These pedals function just like the damper and soft pedal on an acoustic piano.

\* The Soft Pedal can be used as a Sostenuto pedal.

<Sostenuto Pedal>

**How to turn the Soft Pedal to Sostenuto Pedal.**

Connect the DP-2 to the Soft Pedal Jack, and turn the piano on while holding the pedal down.

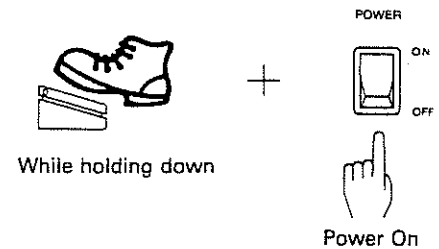

Now, the Soft Pedal works as a Sostenuto Pedal.

When the pedal is turned to a Sostenuto Pedal, it loses the Soft Pedal function.

Pressing the Sostenuto Pedal will turn on the Damper of the note currently played. The following notes will not take on any effect.

\* To return the pedal to the Soft Pedal, turn the piano off once, then turn it on again.

#### d. Brilliance

As you raise the Brilliance knob ④, the tone will be brighter, and mellower when lowered.

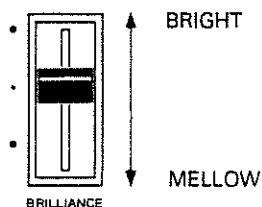

#### e. Chorus/Tremolo

The piano includes built-in Chorus and Tremolo effects.

##### • Chorus

By pressing the Chorus switch ⑫, a lush stereo chorus effect can be obtained through the instrument's internal speaker/amplifier system or via the stereo outputs.



##### • Tremolo

The Tremolo switch ⑬ engages the tremolo effect. The Tremolo circuit is stereo and is especially useful when used with the electric piano and vibraphone sounds.



##### Rate

The Tremolo Rate knob ⑭ is used to increase or decrease the speed of the tremolo effect. Raising it increases the tremolo speed while lowering it decreases the speed of the effect.

##### Depth

Using the Tremolo Depth knob ⑮, the depth of the Tremolo effect can be changed.

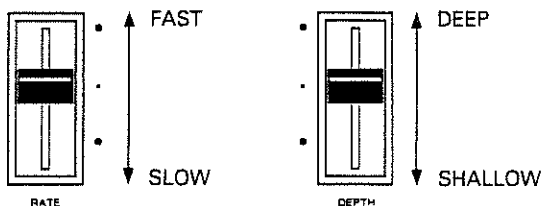

\* On/Off of the Tremolo and/or the Chorus effect can be separately set in each voice and is retained until the piano is turned off.



## f. Key Transpose

By using the appropriate key, you can shift the pitch of the entire keyboard.

\* The RD-200 and RD-300 default to C.

While holding the Key Transpose Switch **5** down, press the key to which you wish to transpose. (F# to F)

Flashing

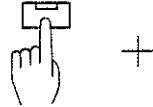

Push the key to which you wish to transpose.

While holding down

When the key other than C is set, the indicator of the Key Transpose will glow.

Once the key is transposed, the Transpose On or Off can be selected by pushing the Key Transpose Switch **5**.

The Key Transpose operation cannot be done if any key is pressed on the keyboard. Be sure no key is pushed when you are transposing the key.

While you are taking the transposing operation, the RD-200 or RD-300 cannot be played.

## 2 RD-200 or RD-300 as a MIDI Device

Part of the power of your RD-200 and RD-300 is in the use of the MIDI (Musical Instrument Digital Interface). To learn more about MIDI and the various music systems that can be added to your RD-200 and RD-300, refer to the enclosed booklet "MIDI" and the MIDI implementation chart in the back of this owner's manual.

### MIDI Connectors

The RD-200 and RD-300 have MIDI IN, MIDI OUT and MIDI THRU Connectors on the rear panel.

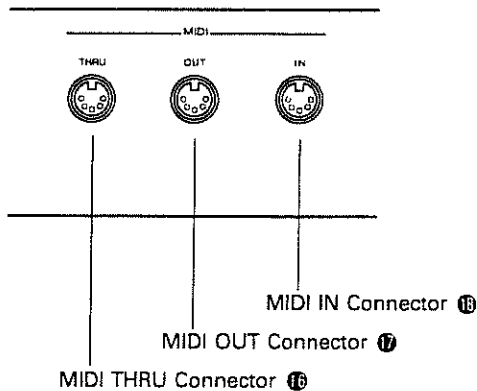

#### ■ MIDI IN Connector 18

When using the piano as a MIDI sound module controlled by the external MIDI device, connect the MIDI IN Connector to the MIDI OUT or MIDI THRU on the external device.

#### ■ MIDI OUT Connector 17

When using the piano as a keyboard controller that drive the external device, connect the MIDI OUT Connector to the MIDI IN on the external device.

#### ■ MIDI THRU Connector 16

Through this, the exact copy of the signal fed into the MIDI IN is sent out.

## 1. RD-200 or RD-300 as a MIDI Keyboard Controller

The RD-200 and RD-300 can be used as perfect MIDI Keyboard Controllers.

The RD-200 and RD-300 default to as follows.

Function		Setting
Split Point		C4 (Split Off)
Transmit Channel	LOWER	1
	UPPER	2
MIDI OUT (On/Off)	LOWER	ON
	UPPER	ON
Internal Voice (On/Off)	LOWER	ON
	UPPER	ON
Receive Channel		1 (OMNI ON)

## a. Setting Transmit MIDI Channel

To use the RD-200 or RD-300 as a MIDI keyboard controller, it is necessary to match the RD-200 or RD-300's transmit channel to the receive channel of the connected MIDI sound module.

The transmit channels of the Lower and the Upper should be set separately.

- ▶ While holding the MIDI Lower Switch ⑧ down, push the key on the keyboard which corresponds to the MIDI channel you want. (from A0 to C2).
- ▶ While holding the MIDI Upper Switch ⑨ down, take the same procedure as above.

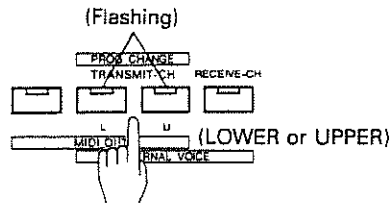

While holding down



Push the key that corresponds to the MIDI channel you want.

\* the Upper and the Lower Channels cannot be set to the same number.

When setting the Transmit channel of 1 to 8, the indicator of the corresponding Voice Selector flashes.

(e.g. 1) When MIDI channel 4 is set.

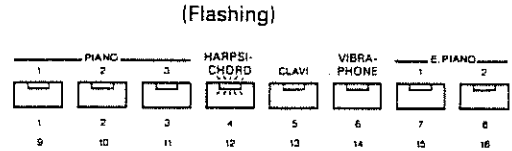

When setting the Transmit Channel of 9 to 16, the indicator of the corresponding Voice Selector flashes and the other Voice Selectors glow.

(e.g. 2) When MIDI channel 13 is set.

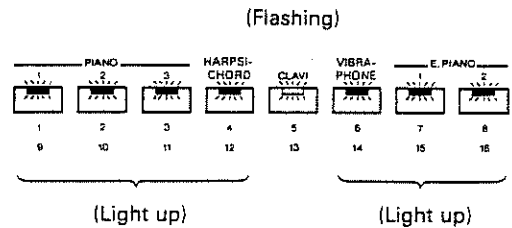

## b. Setting Split Point

### Split Function

The RD-200 and RD-300's Split Functions allow to split the keyboard into the Upper and the Lower sections at any key (Split Point) you like. The Upper and the Lower keyboard can have individual MIDI channel numbers on which different performance information can be simultaneously transmitted to the external sound module.

Split On is called Split Mode, and Split Off Whole Mode.

▶ While holding the Split Switch **6** down, push the key for the Split Point on the keyboard.

\* The key of the Split Point is included in the Upper section.

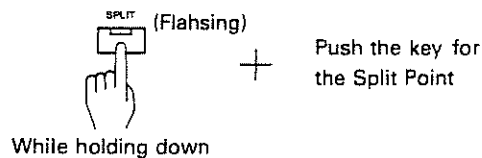

When the Split Point is set, the indicator of the Split Switch **6** lights up.

Once the Split Point is set, the Split mode or the Whole mode can be selected by pushing the Split Switch.

(e.g. 1) When C<sub>4</sub> is selected for the Split Point.

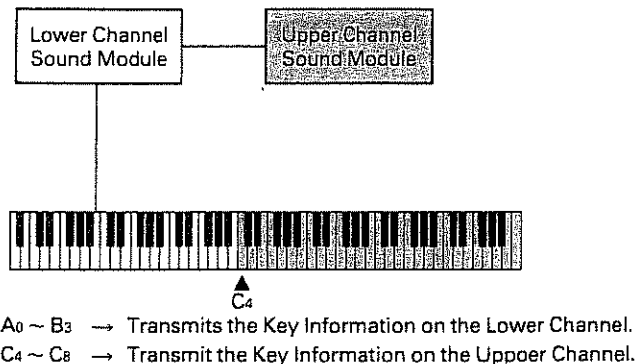

In the Whole Mode (Split Off), all the performance information is sent on the both Upper and Lower channels.

(e.g. 2) When the Split is Off (Whole Mode)

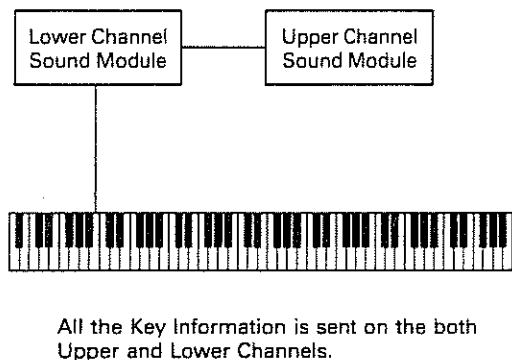

### c. MIDI OUT (On/Off)

MIDI OUT On/Off selects whether or not to send the performance information on the Lower and/or the Upper channels.

- ▶ While holding the MIDI OUT Switch ⑦ down, push the MIDI Lower Switch ⑧ (and/or MIDI Upper Switch ⑨).

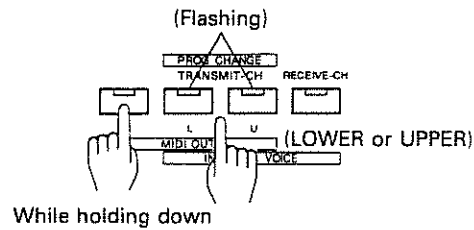

\* Even in the Whole Mode, MIDI OUT On/Off can be individually set for each Lower and Upper.

(e.g. 1) Lower Off, Upper On in the Whole Mode

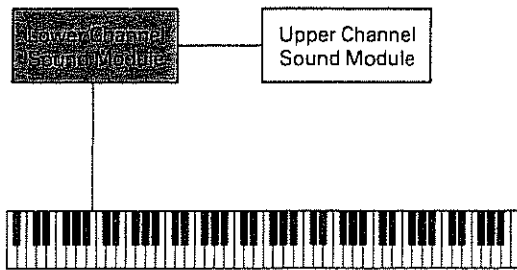

All the performance information is sent on the Upper Channel.

(e.g. 2) Lower On, Upper Off in the Whole Mode

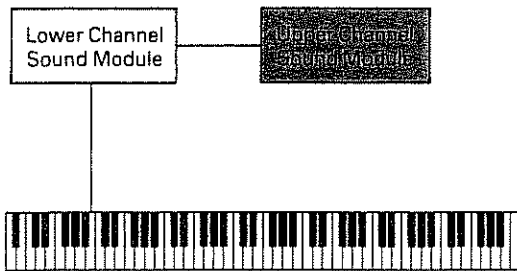

All the Performance Information is sent on the Lower Channel.

### d. Internal Voice (On/Off)

You can select whether or not to transmit the Key information of the Upper and/or the Lower to the internal sound module.

- ▶ While holding the Internal Voice Switch ⑩ down, push the MIDI Lower Switch ⑧ (or the MIDI Upper Switch ⑨).

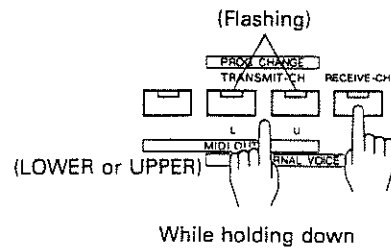

(e.g. 1) Split Point: C<sub>4</sub> (ON)  
Internal Voice: Lower Off, Upper On

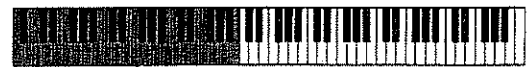

A<sub>0</sub> ~ B<sub>3</sub> → No Sound  
C<sub>4</sub> ~ C<sub>8</sub> → Sound

(e.g. 2) Split Point: C<sub>4</sub> (ON)  
Internal Voice: Lower On, Upper Off



A<sub>0</sub> ~ B<sub>3</sub> → Sound  
C<sub>4</sub> ~ C<sub>8</sub> → No Sound

\* While in the Whole Mode, the Internal Voice cannot be turned off unless both the Lower and the Upper are off.

## e. Transmitting MIDI Information

\* When the MIDI OUT is off (see page 13), no MIDI information can be transmitted.

### • External Volume

With the External Lower Volume Knob ❶ and the External Upper Volume Knob ❷, the volume on the external MIDI sound module can be controlled.

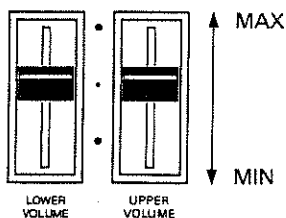

\* The above function cannot be obtained on some external MIDI devices. Please refer to the Implementation Chart shown in the owner's manual of the external MIDI sound module.

### • Chorus, Tremolo (On/Off)

On/Off of the Chorus and/or Tremolo can be transmitted on the Lower and/or the Upper Channels.

▶ While holding the MIDI Lower Switch ❸ (and/or the MIDI Upper Switch ❹) down, push the Chorus Switch ❺ or the Tremolo Switch ❻.

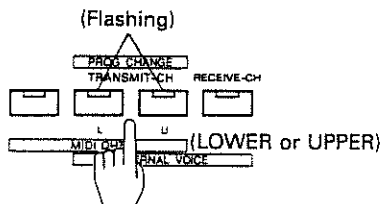

While holding down.

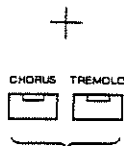

(Chorus or Tremolo)

### • Program Change

The RD-200 and RD-300 can transmit the Program change message 1 to 128 on the Lower and/or the Upper channels.

The table below shows how the Group/Bank/Voice Number on the RD-200 and RD-300 correspond to the Program Change numbers.

Program Change Table

	BANK	NO	1	2	3	4	5	6	7	8
A	1	1	2	3	4	5	6	7	8	
	2	9	10	11	12	13	14	15	16	
	3	17	18	19	20	21	22	23	24	
	4	25	26	27	28	29	30	31	32	
	5	33	34	35	36	37	38	39	40	
	6	41	42	43	44	45	46	47	48	
	7	49	50	51	52	53	54	55	56	
	8	57	58	59	60	61	62	63	64	
B	1	65	66	67	68	69	70	71	72	
	2	73	74	75	76	77	78	79	80	
	3	81	82	83	84	85	86	87	88	
	4	89	90	91	92	93	94	95	96	
	5	97	98	99	100	101	102	103	104	
	6	105	106	107	108	109	110	111	112	
	7	113	114	115	116	117	118	119	120	
	8	121	122	123	124	125	126	127	128	

▶ While holding the MIDI Lower Switch ❸ (or the MIDI Upper Switch ❹) down, push the key that corresponds to the Group/Bank/Voice number.

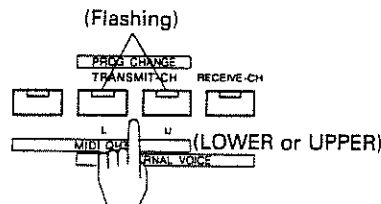

While holding down.



Push the key that corresponds to the Group/Bank/Voice Number.

## 2. RD-200 or RD-300 as MIDI Sound Module

### a. Setting Receive Channel

When using the RD-200 or RD-300 as a MIDI sound module, you should set the receive MIDI channel of the RD-200 or RD-300 to the same number as the transmit channel of the MIDI device that controls the RD-200 or RD-300.

- ▶ While holding the MIDI Receive Channel Switch  down, push the key (from A0 to C2) that corresponds to the MIDI channel you want.

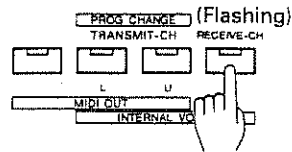

While holding down.



Push the key that corresponds to the MIDI Channel you want.

When setting the Receive MIDI channel, the indicator of the Voice Selectors will react just like when setting the Transmit MIDI channel. (See page 11 "a. Setting Transmit MIDI Channel".)

### b. Receiving MIDI Information

- Program Change

The RD-200 and RD-300 can receive the Program Change from 1 to 32 but ignore 33 to 128.

- \* The detailed explanation on the transmitting and receiving messages follows in the next section "3. MIDI Functions".

### 3. MIDI Functions

The RD-200 and RD-300 can select any of the following three modes that decide how the messages are received and transmitted.

- (I) By taking the procedure shown from page 11 to 15, Note On/Off, Program Change and Control Change are transmitted and received.
- (II) Note On/Off, Program Change and Control Change are transmitted and received.
  - The moment a new voice is selected on the RD-200 or RD-300, the corresponding program change number is transmitted. The chorus or tremolo On/Off is transmitted as a control change message. This setting may be used when recording the data into a MIDI sequencer and play it back.
- (III) Note On/Off, Program Change and Control Change are transmitted. Program Change, Chorus On/Off and Tremolo On/Off cannot be received.

\* Refer to MIDI Implimentation Chart in the back of this owner's manual.

#### How to select the above communication mode

- Mode (I):** Turning the RD-200 or RD-300 on will automatically selects this mode.
- Mode (II):** Turn the RD-200 or RD-300 on while holding the MIDI OUT Switch ⑦ down.
- Mode (III):** Turn the RD-200 or RD-300 on while holding down the Voice Selector Piano-1.



## ■ Other Function

### ● Remote Pedal

Connect the supplied pedal switch DP-2 to the Remote Pedal Jack , and the DP-2 can be used as a remote switch for the Key Transpose, Split, MIDI OUT, MIDI Lower, MIDI Upper, Receive Channel/Internal Voice, Chorus or Tremolo switch.

- ▶ While holding down the relevant switch (Key Transpose, Split, MIDI OUT, MIDI Lower, MIDI Upper, Receive Channel/Internal Voice Chorus or Tremolo), press the Pedal Switch.

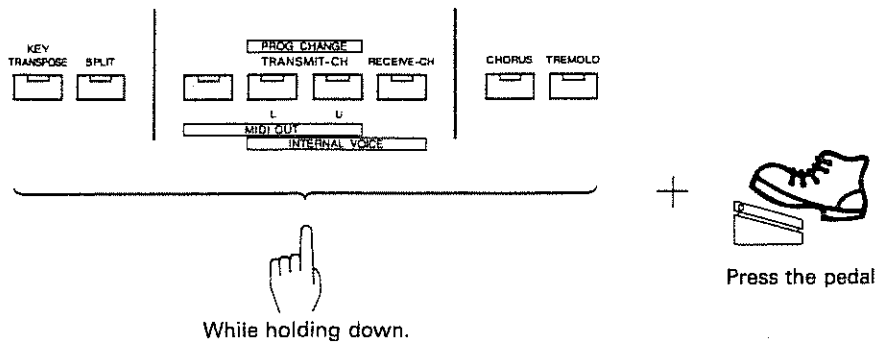

\* When the pedal is used as a remote pedal, it does not function as a soft pedal. If you wish to use it as a soft pedal, turn the RD-200 or RD-300 off once, then turn it on again.

# ■ Sound Range Diagram

## RD-200

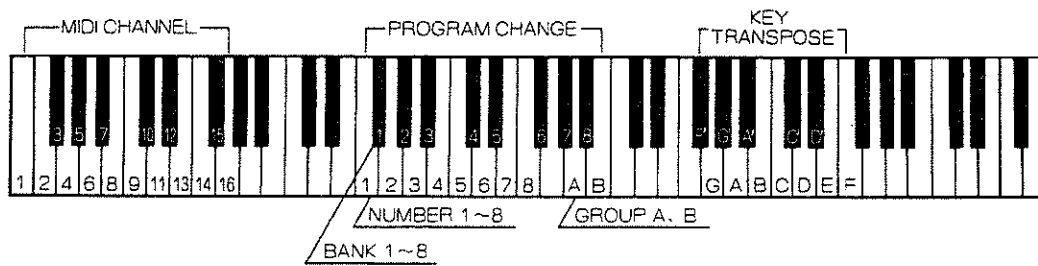
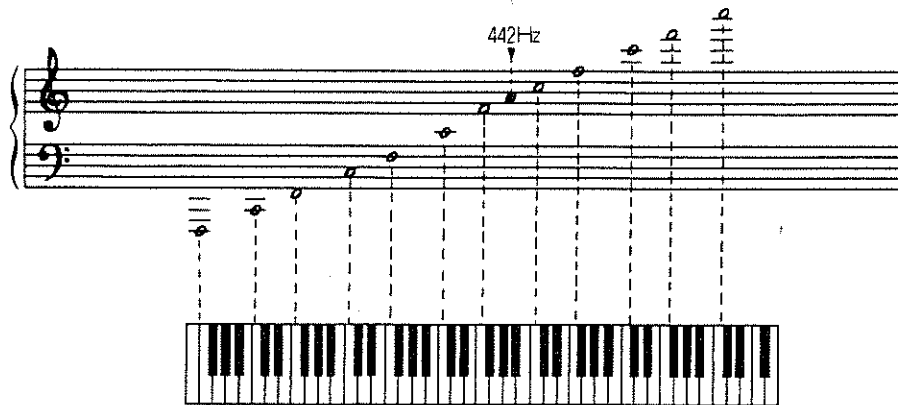

## RD-300

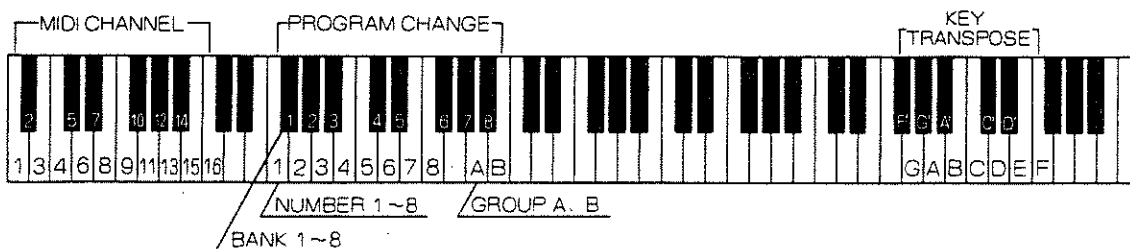
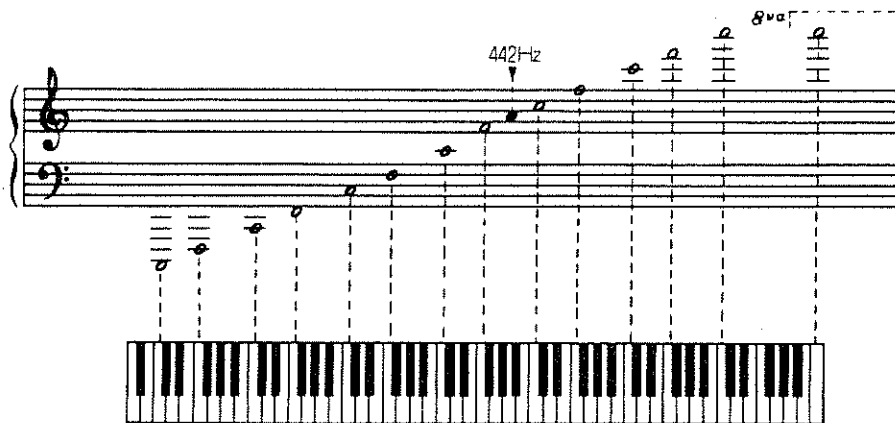



# MODEL RD-200/300 MIDI Implementation

Date : Aug. 20, 1986  
Version : 1.0

## 1. TRANSMITTED DATA

Status	Second	Third	Description	
1001 nnnn	0kkk kkkk	0000 0000	Note OFF	
1001 nnnn	0kkk kkkk	0vvv vvvv	Note ON kkkkkkk = 15 - 113 / RD-300 22 - 108 / RD-200 vvvvvvv = 1 - 127	*1
1011 nnnn	0000 0111	0vvv vvvv	Volume vvvvvvv = 0 - 127	*6
1011 nnnn	0100 0000	0111 1111	Hold1 ON	
1011 nnnn	0100 0000	0000 0000	Hold1 OFF	
1011 nnnn	0100 0010	0111 1111	Sostenuto ON	*2
1011 nnnn	0100 0010	0000 0000	Sostenuto OFF	
1011 nnnn	0100 0011	0111 1111	Soft ON	*2
1011 nnnn	0100 0011	0000 0000	Soft OFF	
1011 nnnn	0101 1100	0111 1111	Tremolo ON	*3
1011 nnnn	0101 1100	0000 0000	Tremolo OFF	*3
1011 nnnn	0101 1101	0111 1111	Chorus ON	*3
1011 nnnn	0101 1101	0000 0000	Chorus OFF	*3
1100 nnnn	0ppp pppp		Program Change ppppppp = 0 - 127	*4
1011 nnnn	0111 1011	0000 0000	ALL NOTES OFF	*5
1011 nnnn	0111 1100	0000 0000	OMNI OFF	*6
1011 nnnn	0111 1111	0000 0000	POLY ON	*6
1111 1110			Active Sensing	

\*2 If the power has been applied with the PIANO 1 switch being held down, this message is ignored.

\*3 Refer to 8. PROGRAM CHANGE IN RECEIVING.

\*4 When the ALL NOTES OFF is recognized, all MIDI-on notes are turned OFF. However, if the damper pedal is being pressed, these ON notes will not be turned OFF until the damper pedal is released. Similarly, if the MIDI Hold1 ON message has been received, the notes will not be turned off until the Hold1 OFF message is received.

\*5 These Mode Messages (2nd byte = 123 - 127) are also recognized as the ALL NOTES OFF.

Mode Messages are recognized as follows:

	POLY ON (127)	MONO ON (126)	MONO ON (126)
		mmmm = 1	mmmm (> 1)
OMNI OFF (124)	OMNI = OFF POLY	OMNI = OFF POLY	OMNI = ON POLY
OMNI ON (125)	OMNI = ON POLY	OMNI = ON POLY	OMNI = ON POLY

## 3. BASIC CHANNEL IN TRANSMITTING

When the power is first applied, the Lower Basic Channel is normally set to 2, and Upper Basic Channel is normally set to 1.

However, the Basic Channel may be changed when the following key on the keyboard is pressed while the Lower (or Upper) PROGRAM CHANGE switch being held down. Lower and Upper can not be set at same channel.

Key	Basic Channel
A 0	1
A# 0	2
B 0	3
C 1	4
C# 1	5
D 1	6
D# 1	7
E 1	8
F 1	9
F# 1	10
G 1	11
G# 1	12
A 1	13
A# 1	14
B 1	15
C 2	16

When Lower (or Upper) Basic Channel is changed, following message are transmitted.

In the previous Basic Channel.

- a. Hold1 OFF (If Damper pedal is trodden.)
  - b. Sostenuto OFF (If Sostenuto pedal is trodden.)
  - c. Soft OFF (If Soft pedal is trodden.)
- When set to MIDI OUT OFF by panel operation, these messages are not sent.

In the new Basic Channel.

- a. OMNI OFF
  - b. POLY ON
  - c. Volume
  - d. Hold1 ON (if Damper pedal is trodden)
  - e. Sostenuto ON (if Sostenuto pedal is trodden)
  - f. Soft ON (if Soft pedal is trodden)
- When set to MIDI OUT OFF by panel operation, c,d,e and f messages are not sent.

## 4. BASIC CHANNEL IN RECEIVING

When the power is first applied, the Basic Channel is normally set to 1, and the receiver is set to the MODE 1 (OMNI ON, POLY).

However, the Basic Channel may be changed when the following key on the keyboard is pressed while the RECEIVE-CH switch being held down. The receiver will be set to the MODE 3 (OMNI OFF, POLY).

Key	Basic Channel	OMNI
Power-up	1	ON
A 0	1	OFF
A# 0	2	OFF
B 0	3	OFF
C 1	4	OFF
C# 1	5	OFF
D 1	6	OFF
D# 1	7	OFF
E 1	8	OFF
F 1	9	OFF
F# 1	10	OFF
G 1	11	OFF
G# 1	12	OFF
A 1	13	OFF
A# 1	14	OFF
B 1	15	OFF
C 2	16	OFF

## 2. RECOGNIZED RECEIVE DATA

Status	Second	Third	Description	
1000 nnnn	0kkk kkkk	0vvv vvvv	Note OFF, velocity ignored	
1001 nnnn	0kkk kkkk	0000 0000	Note OFF kkkkkkk = 0 - 127 (15 - 113)	*1
1001 nnnn	0kkk kkkk	0vvv vvvv	Note ON kkkkkkk = 0 - 127 (15 - 113) vvvvvvv = 1 - 127	*1
1011 nnnn	0100 0000	0vvv vvvv	Hold1 OFF vvvvvvv = 0 - 63	
1011 nnnn	0100 0000	0vvv vvvv	Hold1 ON vvvvvvv = 64 - 127	
1011 nnnn	0100 0010	0vvv vvvv	Sostenuto OFF vvvvvvv = 0 - 63	
1011 nnnn	0100 0010	0vvv vvvv	Sostenuto ON vvvvvvv = 64 - 127	
1011 nnnn	0100 0011	0vvv vvvv	Soft OFF vvvvvvv = 0 - 63	
1011 nnnn	0100 0011	0vvv vvvv	Soft ON vvvvvvv = 64 - 127	
1011 nnnn	0101 1100	0vvv vvvv	Tremolo OFF vvvvvvv = 0 - 63 *2	
1011 nnnn	0101 1100	0vvv vvvv	Tremolo ON vvvvvvv = 64 - 127 *2	
1011 nnnn	0101 1101	0vvv vvvv	Chorus OFF vvvvvvv = 0 - 63 *2	
1011 nnnn	0101 1101	0vvv vvvv	Chorus ON vvvvvvv = 64 - 127 *2	
1100 nnnn	0ppp pppp		Program Change ppppppp = 0 - 31	*3
1011 nnnn	0111 1011	0000 0000	ALL NOTES OFF	*4
1011 nnnn	0111 1100	0000 0000	OMNI OFF	*5
1011 nnnn	0111 1101	0000 0000	OMNI ON	*5
1011 nnnn	0111 1110	0000 0000	MONO ON	*5
1011 nnnn	0111 1111	0000 0000	POLY ON	*5
1111 1110			Active Sensing	

Notes :  
nnnn : MIDI Channel number ( 0000 - 1111 ), ch-1 = 0000  
The Basic Channel can be changed by panel operation.  
Refer to 4. BASIC CHANNEL IN RECEIVING.

\*1 Note numbers outside of the range 15 - 113 are transposed to the nearest octave inside this range.  
The Key Transpose operation from the panel does not affect MIDI IN NOTE numbers

5. KEY TRANSPOSE

When the power is first applied, transpose value is 0.  
The following chart shows the relationship between key positions and transposed values. (Set when a key is pressed while the KEY TRANSPOSE switch is being held down.)

Key	Transposed value (semitone)	Transmitted note range
power-up	0	21 - 108
F# 6	-6	15 - 102
G 6	-5	16 - 103
G# 6	-4	17 - 104
A 6	-3	18 - 105
A# 6	-2	19 - 106
B 6	-1	20 - 107
C 6	0	21 - 108
C# 6	+1	22 - 109
D 6	+2	23 - 110
D# 6	+3	24 - 111
E 6	+4	25 - 112
F 6	+5	26 - 113

6. TREMOLO, CHORUS IN TRANSMITTING

When the CHORUS (TREMOLO) switch is pressed while the Lower (or Upper) PROGRAM CHANGE switch is being held down, the CHORUS (TREMOLO) ON or OFF message is sent.  
If the power has been applied with the MIDI OUT switch being held down, pressing CHORUS (TREMOLO) switch sends CHORUS (TREMOLO) ON or OFF message, whichever appropriate.

7. PROGRAM CHANGE IN TRANSMITTING

The following table shows the GROUP, BANK and NUMBER values related with key position which is set while the Lower (or Upper) PROGRAM CHANGE switch being held down.

Key	Related value
A 3	GROUP A
B 3	GROUP B
F# 2	BANK 1
G# 2	BANK 2
A# 2	BANK 3
C# 3	BANK 4
D# 3	BANK 5
F# 3	BANK 6
G# 3	BANK 7
A# 3	BANK 8
F 2	NUMBER 1
G 2	NUMBER 2
A 2	NUMBER 3
B 2	NUMBER 4
C 3	NUMBER 5
D 3	NUMBER 6
E 3	NUMBER 7
F 3	NUMBER 8

When one of the above-mentioned keys is pressed while the Lower (or Upper) PROGRAM CHANGE switch being held down, a Program Change message will be transmitted.  
The transmitted program change numbers are related with the GROUP, BANK and NUMBER values as follows.

GROUP A

NUMBER	1	2	3	4	5	6	7	8
BANK 1	0	1	2	3	4	5	6	7
BANK 2	8	9	10	11	12	13	14	15
BANK 3	16	17	18	19	20	21	22	23
BANK 4	24	25	26	27	28	29	30	31
BANK 5	32	33	34	35	36	37	38	39
BANK 6	40	41	42	43	44	45	46	47
BANK 7	48	49	50	51	52	53	54	55
BANK 8	56	57	58	59	60	61	62	63

GROUP B

NUMBER	1	2	3	4	5	6	7	8
BANK 1	64	65	66	67	68	69	70	71
BANK 2	72	73	74	75	76	77	78	79
BANK 3	80	81	82	83	84	85	86	87
BANK 4	88	89	90	91	92	93	94	95
BANK 5	96	97	98	99	100	101	102	103
BANK 6	104	105	106	107	108	109	110	111
BANK 7	112	113	114	115	116	117	118	119
BANK 8	120	121	122	123	124	125	126	127

If the power has been applied with the MIDI OUT switch being held down, the following Program Change message will be sent when respective number is selected by panel operation.

Switch	Prog #
PIANO 1	0
PIANO 2	1
PIANO 3	2
HARPSICHORD	3
CLAVI	4
VIBRAPHONE	5
E.PIANO 1	6
E.PIANO 2	7

8. PROGRAM CHANGE IN RECEIVING

If the power has been applied with the PIANO 1 switch being held down, this message is ignored.

The assignment of received Program Change messages are as follows. The program numbers 32 - 127 are ignored.

Prog #	Voice	CHORUS	TREMOLO
0	PIANO 1	OFF	OFF
1	PIANO 2	OFF	OFF
2	PIANO 3	OFF	OFF
3	HARPSICHORD	OFF	OFF
4	CLAVI	OFF	OFF
5	VIBRAPHONE	OFF	OFF
6	E.PIANO 1	OFF	OFF
7	E.PIANO 2	OFF	OFF
8	PIANO 1	ON	OFF
9	PIANO 2	ON	OFF
10	PIANO 3	ON	OFF
11	HARPSICHORD	ON	OFF
12	CLAVI	ON	OFF
13	VIBRAPHONE	ON	OFF
14	E.PIANO 1	ON	OFF
15	E.PIANO 2	ON	OFF
16	PIANO 1	OFF	ON
17	PIANO 2	OFF	ON
18	PIANO 3	OFF	ON
19	HARPSICHORD	OFF	ON
20	CLAVI	OFF	ON
21	VIBRAPHONE	OFF	ON
22	E.PIANO 1	OFF	ON
23	E.PIANO 2	OFF	ON
24	PIANO 1	ON	ON
25	PIANO 2	ON	ON
26	PIANO 3	ON	ON
27	HARPSICHORD	ON	ON
28	CLAVI	ON	ON
29	VIBRAPHONE	ON	ON
30	E.PIANO 1	ON	ON
31	E.PIANO 2	ON	ON

The assignment of received Program Change messages can be set at another mode that is set if the power is applied while the MIDI OUT switch being held down. In this mode assignment does not affect the TREMOLO and CHORUS.  
The assignment of received Program Change messages are as follows. The program numbers 8 - 127 are ignored.

Prog #	Voice
0	PIANO 1
1	PIANO 2
2	PIANO 3
3	HARPSICHORD
4	CLAVI
5	VIBRAPHONE
6	E.PIANO 1
7	E.PIANO 2

Even if the Program Change message is recognized, the VOICE will not be changed to the new VOICE until all on-notes are turned OFF and Hold1 is turned OFF.

# MODEL RD-200/300 MIDI Implementation Chart

Date : Aug. 20, 1986  
Version : 1.0

Function.....		Transmitted	Recognized	Remarks
Basic Channel	Default Changed	1,2 1-16	1 1-16	
Mode	Default Messages Altered	3 POLY, OMNI OFF *****	1 POLY, OMNI ON/OFF MONO(M ≠ 1) → 1, (M=1) → 3	
Note Number	True voice	15-113(RD-300), 22-108(RD-200) *****	0-127 15-113	
Velocity	Note ON Note OFF	○ × (9n v=0)	○ ×	v=1-127
After Touch	Key's Ch's	× ×	× ×	
Pitch Bender		×	×	
Control Change	7 64 66 67 92 93	○ ○ ○ ○ ○ ○	× ○ ○ ○ ○ ○	Volume Hold 1 Sostenuto Soft pedal Tremolo Chorus
Prog Change	True #	○ (0-127) *****	○(0-31) 0-31	can be ignored by power-up setting
System Exclusive		×	×	
System Common	Song Pos Song Sel Tune	× × ×	× × ×	
System Real Time	Clock Commands	× ×	× ×	
Aux Messages	Local ON/OFF All Notes OFF Active Sense Reset	× ○ ○ ×	× ○ (123-127) ○ ×	
Notes		When power up, ch-1 OMNI OFF and POLY are sent. When Basic channel is changed, Mode is set to 3.		

Mode 1 : OMNI ON, POLY  
Mode 3 : OMNI OFF, POLY

Mode 2 : OMNI ON, MONO  
Mode 4 : OMNI OFF, MONO

○ : Yes  
× : No

## ■ Specifications

### RD-300/200

88 key (RD-300), 76 key (RD-200), 16 Voice Polyphonic, SA System Digital Piano  
(10 Voice Polyphonic for Harpsichord, Clavi and Electric Piano 2)

#### Preset Voices

Piano, 1, 2, and 3  
Harpsichord  
Clavi  
Vibraphone  
Electric Piano 1, 2

#### Effects

Chorus (On/Off)  
Tremolo (On/Off, Rate, Depth)

#### Panel Switches

Key Transpose  
Split  
MIDI OUT  
MIDI Lower  
MIDI Upper  
Receive Channel/Internal Voice  
Voice Selectors × 8  
Chorus  
Tremolo

#### Controls

External Lower Volume  
External Upper Volume  
Volume  
Brilliance  
Tremolo Rate  
Tremolo Depth

#### Indicators

Key Transpose  
Split  
MIDI OUT  
MIDI Lower  
MIDI Upper  
Receive Channel/Internal Voice × 8  
Chorus  
Tremolo

#### REAR PANEL

Receptacle  
Power Switch  
Headphones Jack (stereo)  
Output Jacks (L and R)  
Output Level Switch (L/M/H)  
Tuning Knob  
Soft/Remote Pedal Jack  
Damper Pedal Jack  
MIDI Connectors (IN, OUT, THRU)

#### Dimensions

RD-300: 1405(W) × 461(D) × 133(H) mm  
55-5/16" × 18-1/8" × 5-1/4"  
RD-200: 1142(W) × 422(D) × 107(H) mm  
44-15/16" × 16-5/8" × 4-3/16"

#### Weight

RD-300: 27.2kg/60 lb  
RD-200: 16kg/35 lb 4 oz

#### Power Consumption:

20W (117V), 25W (220V, 240V)

#### Accessories:

Power Cord × 1  
Connection Cord (LP-25) × 2  
Pedal Switch (DP-2) × 1  
Owner's Manual  
Guide Book "MIDI,,

#### OPTIONS

Stand  
Stereo Headphones: RH-100, RH-10  
MIDI Cable: MSC-07, 15, 25, 50, 100

 Roland®

10500

UPC 10500



10500

D-200/300

 Roland

86-11-AGA1-1S