

**BIBOSSES**

**RCE-10**

**DIGITAL**

**CHORUS ENSEMBLE**

**INSTRUCTIONS**

Please read the instructions carefully.

Adopting the LSI newly developed specifically for digital chorus, the BOSS Digital Chorus Ensemble RCE-10 allows extremely rich chorus sounds.

- Owing to the BOSS special digital modulation, the RCE-10 can produce perfect chorus modulation which has been impossible by the analog modulation.
- The RCE-10 features two chorus circuits and the perfectly synchronizing digital modulation, therefore, extremely natural dimension effect can be obtained.
- The RCE-10 provides the Pre-delay Time control as well as the Rate and Depth, allowing wide variation of effects from chorus to doubling.
- The built-in equalizer serves to vary the chorus sharp to mild.

## CONTENTS

1	Panel Description	3
2	Connection	5
3	Operation	6
4	Setting Samples	8
5	Important Notes	10
6	Specifications	11

## RADIO AND TELEVISION INTERFERENCE

**\*Warning** - This equipment has been verified to comply with the limits for a Class B computing device, which provides for protection against interference with non-certified or non-verified equipment. It is likely to result in interference to radio and TV.

The equipment described in this manual generates and uses radio-frequency energy. If it is not installed and operated in strict accordance with our instructions, it may cause interference with radio and television reception.

This equipment has been tested and found to comply with the limits for a Class B computing device in accordance with the requirements in Subpart J, of Part 15, of FCC Rules. These rules are designed to provide reasonable protection against interference to radio and television reception. However, there is no guarantee that interference will not occur in a particular installation. If this equipment does cause interference to radio or television reception, which can be determined by the following measures, and off, the user is encouraged to try to correct the interference by the following measures:

- Disconnect other devices and their input/output cables one at a time. If the interference stops, it may be caused by one of these devices or its I/O cables. If the interference does not stop, you can obtain the proper shielded cable from your dealer. For non-Roland devices, contact the manufacturer or dealer for assistance.
- Turn the TV or radio antenna until the interference stops.
- Turn the TV or radio antenna to one side or the other of the TV or radio.
- Move the equipment to one side of the outlet that is on a different circuit than the TV or radio.
- Plug the equipment into an outlet that is on a different circuit than the TV or radio.
- Consider installing a rooftop television antenna with coaxial cable lead-in between the antenna and TV.

If necessary, you should consult your dealer or an experienced radio/television technician for additional suggestions. Your dealer may find helpful the following booklet prepared by the Federal Communications Commission:

"How to Identify and Resolve Radio-TV Interference Problems"  
 This booklet is available from the U.S. Government Printing Office, Washington, D.C., 20402, Stock No. GSA-000-903-947-4.

## Bescheinigung des Herstellers/Importeurs

Hiermit wird bescheinigt, daß der/die/das

- BOSS DIGITAL CHORUS ENSEMBLE RCE-10

(Gerät, Typ, Bezeichnung)

in Übereinstimmung mit den Bestimmungen der

Amtsbl. Vfg 1046 / 1984

(Amtsblattverfügung)

funk entsteht ist.

Der Deutschen Bundespost wurde das Inverkehrbringen dieses Gerätes angezeigt und die Berechtigung zur Überprüfung der Serie auf Einhaltung der Bestimmungen eingeräumt.

Roland Corporation Osaka/Japan

Name des Herstellers/Importeurs

# 1 PANEL DESCRIPTION

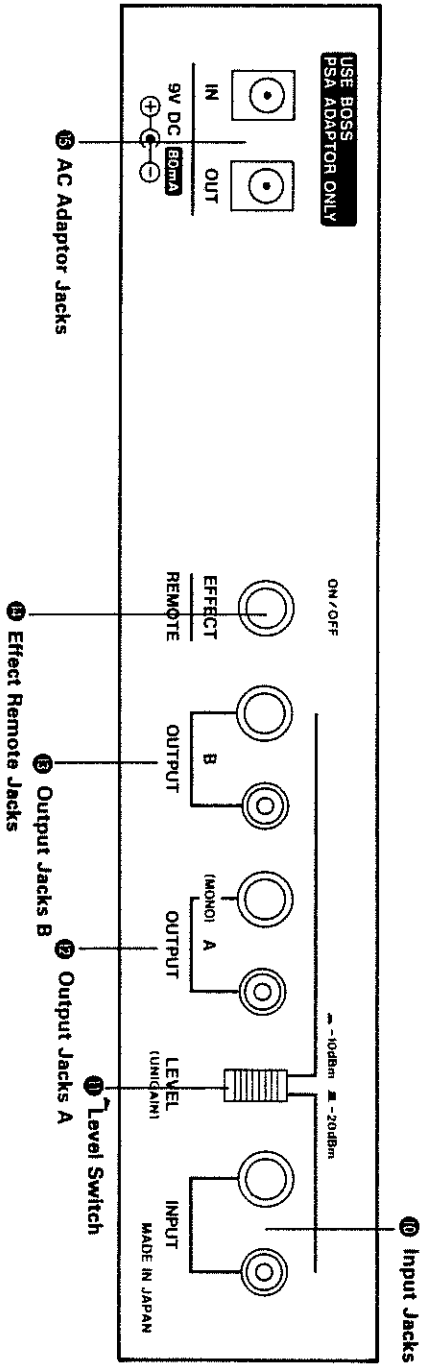
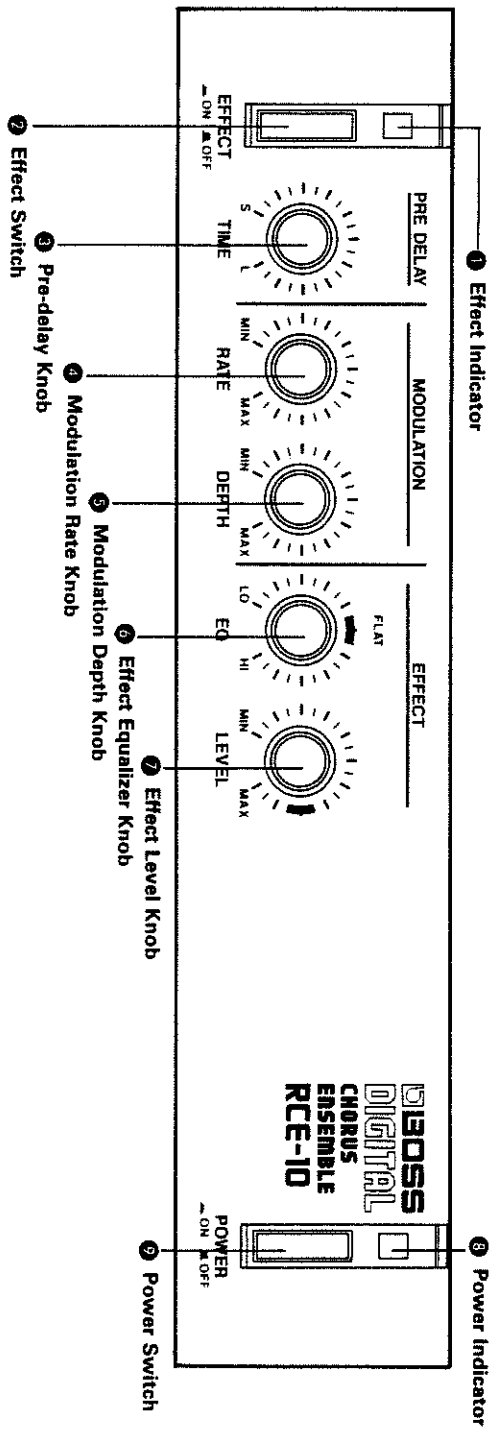

- 1 Effect Indicator**  
This lights up when the effect is turned on. So, you can easily see whether the effect is on or off.
  - 2 Effect Switch**  
This turns the effect on or off.
  - 3 Pre-delay Time knob**
  - 4 Modulation Rate Knob**
  - 5 Modulation Depth Knob**
- } See "[3] Operation".
- 6 Effect Equalizer Knob**
  - 7 Effect Level Knob**
  - 8 Power Indicator**  
This lights up when the unit is switched on.
  - 9 Power Switch**  
This turns the unit on or off.  
\* For about ten seconds after the unit is turned on, it does not work.
  - 10 Input Jacks**  
Connect a musical instrument or audio equipment to this jack.  
\* These are two input jacks; standard phone and pin, but they cannot be used at the same time. If both are connected, the standard phone jack will have priority.
  - 11 Level Switch** See "[3] Operation".
  - 12 Output Jacks A**  
Through this jack, effect sound is sent out.  
\* Two output jacks can be simultaneously used.  
\* For monaural connection, use the standard phone jack.
  - 13 Output Jacks B**  
Through this jack, the effect sound with the inverted modulation of the Output A is sent out.  
\* Two output Jacks can be simultaneously used.
  - 14 Effect Remote Jack**  
By connecting the Footswitch FS-1 (optional) to this jack, you can turn the effect on or off by pressing the pedal.  
\* Before using this function, be sure to turn the Effect Switch on.
  - 15 AC Adaptor Jacks**  
The "IN" jack is to connect the AC adaptor (BOSS PSA-120, 220 or 240) or Power Supply (BOSS RPW-7). Connect the plug of the AC adaptor or the Power Supply to "IN". To supply power to other BOSS Micro Studio Series, connect the supplied DC cord to "OUT".  
\* When using the PSA Adaptor, please be sure the total current draw does not exceed 200mA, and when using the RPW-7, 700mA. (The current draw of each unit is shown on its rear panel.)

## 2 CONNECTION

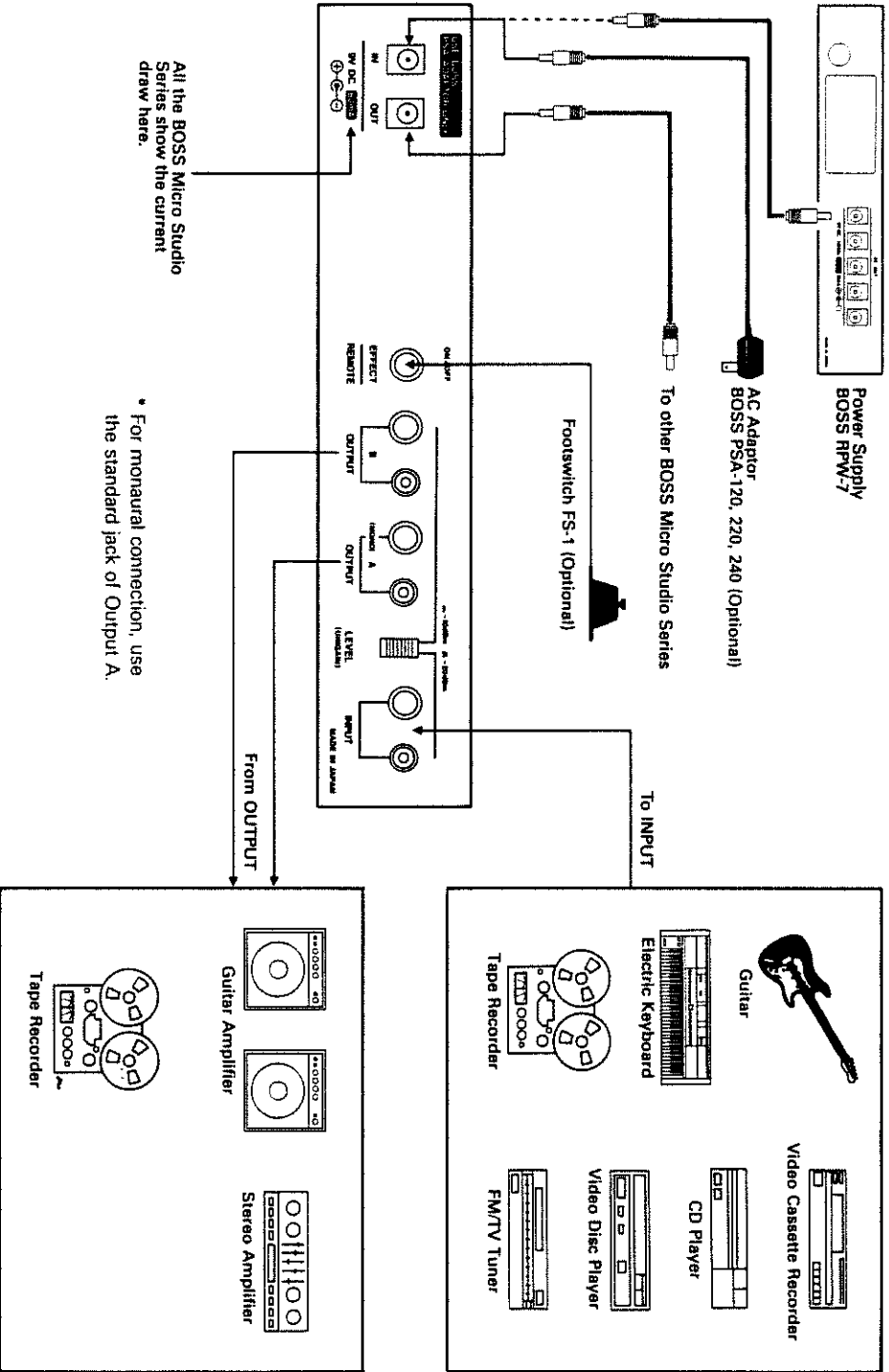

### 3 OPERATION

- 1 Set the controls on the panel as shown below.

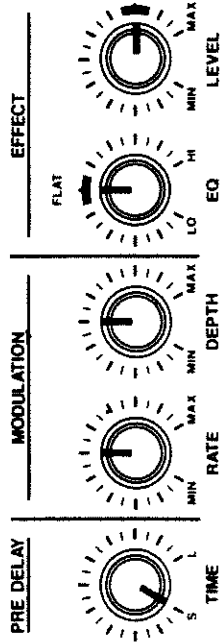

- 2 Set the Level Switch to the appropriate position depending on the type of the unit used.

\* If the sound is distorted with the switch set to the " -20dBm " position, change it to " -10dBm " .



LEVEL (UNIGAIN)

- 3 Set the time needed for the chorus effect to come on using the Pre delay Time Knob 3. Rotating the knob clockwise makes the time longer, and at its MAX position, the doubling effect is obtained.

\* If you rotate the knob as you actually play the instrument, noise may be heard, but there is no need to worry about it.

PRE DELAY



- 4 Set the rate of the chorus modulation using the Modulation Rate Knob 4. Clockwise rotation will quicken the rate.

MODULATION

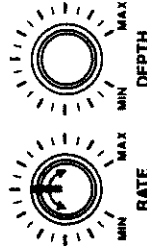

⑤ Set the depth of the chorus modulation using the Modulation Depth Knob ⑤. Clockwise rotation will deepen the modulation.

\* When both the Rate and the Depth Knobs are simultaneously rotated, one of the two chorus modulations may stop, but it will start again within five seconds.

**MODULATION**

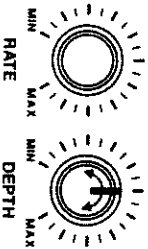

⑦ Set the balance of the effect and the normal sounds using the Effect Level Knob ⑦. As you rotate the knob clockwise, the level of the effect sound increases.

\* At the fully counterclockwise position, only direct sound is heard.

**EFFECT**

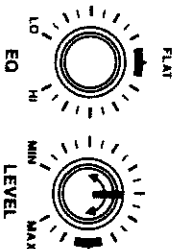

⑥ Set the tone of the chorus sound using the Effect Equalizer Knob ⑥. As you rotate the knob clockwise, the lower frequencies are cut and the higher frequencies are boosted, creating sharper sound, and vice versa.

\* The equalizer does not work on the direct sounds.

**EFFECT**

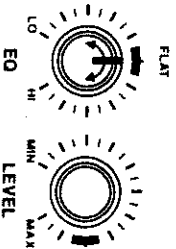

## 4 SETTING SAMPLES

### 1) Rich Chorus

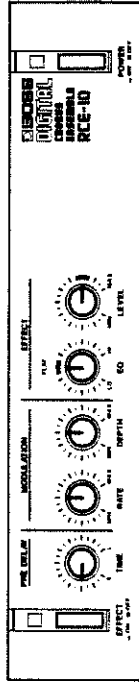

### 3) Doubling Chorus

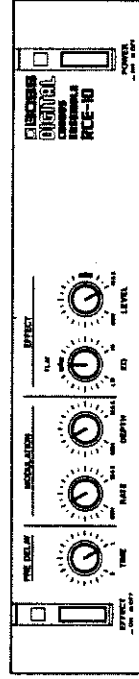

### 2) Light Chorus

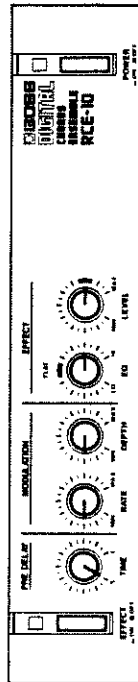

### 4) Tremolo Chorus

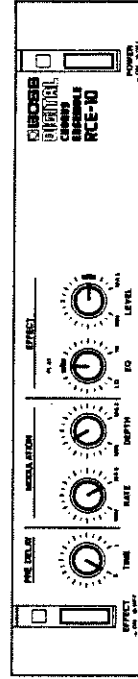



— Setting Memo —

<b>PRE DELAY</b> 	<b>MODULATION</b> 	<b>MODULATION</b> 	<b>EFFECT</b> FLAT 	<b>EFFECT</b> 
----------------------	-----------------------	-----------------------	---------------------------	-------------------

<b>PRE DELAY</b> 	<b>MODULATION</b> 	<b>MODULATION</b> 	<b>EFFECT</b> FLAT 	<b>EFFECT</b> 
----------------------	-----------------------	-----------------------	---------------------------	-------------------

<b>PRE DELAY</b> 	<b>MODULATION</b> 	<b>MODULATION</b> 	<b>EFFECT</b> FLAT 	<b>EFFECT</b> 
----------------------	-----------------------	-----------------------	---------------------------	-------------------

<b>PRE DELAY</b> 	<b>MODULATION</b> 	<b>MODULATION</b> 	<b>EFFECT</b> FLAT 	<b>EFFECT</b> 
----------------------	-----------------------	-----------------------	---------------------------	-------------------

<b>PRE DELAY</b> 	<b>MODULATION</b> 	<b>MODULATION</b> 	<b>EFFECT</b> FLAT 	<b>EFFECT</b> 
----------------------	-----------------------	-----------------------	---------------------------	-------------------

<b>PRE DELAY</b> 	<b>MODULATION</b> 	<b>MODULATION</b> 	<b>EFFECT</b> FLAT 	<b>EFFECT</b> 
----------------------	-----------------------	-----------------------	---------------------------	-------------------

## 5 NOTES

- For about 10 seconds after the unit is turned on, it does not function because of the muting circuit.
- When you are using only one AC adaptor for supplying power to more than one unit, please be sure that the total current draw does not exceed 200mA.
- When the unit is not to be used, disconnect the AC adaptor from the socket.
- Avoid using the unit in excessive heat or humidity or where it may be affected by dust.
- Please never remove the cabinet from the unit.
- When you use the unit on its own without using the optional Rack Mount Adaptor RAD-10, please attach the rubber feet as shown below.

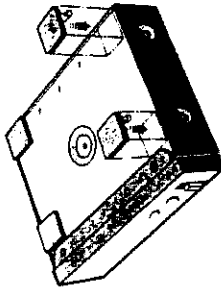

## ■ AC Adaptor, Power Supply BOSS PSA-120, 220 or 240 (optional) BOSS RPW-7 (optional)

Be sure to use the above AC adaptor or power supply. Using any other adaptor or power supply will cause trouble.

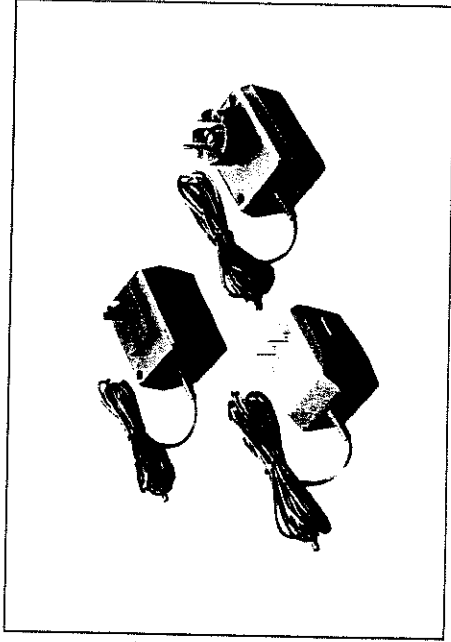

## ■ RACK MOUNTING

The RCE-10 is one of the BOSS Micro Studio Series, and any two of the series can be mounted in a standard 19" rack (EIA-1U) by using the optional Rack Mount Adaptor RAD-10.

Remove the rubber feet from the bottom of the units, fix the units on the Rack Mount Adaptor with the supplied screws, then place the whole set on the rack.

## **6 SPECIFICATIONS**

**Input Level/Input Impedance:**

–20dBm/1M $\Omega$ , –10dBm/47k $\Omega$

**Output Level/Output Impedance:**

–20dBm/2k $\Omega$ , –10dBm/2k $\Omega$

**Output Load Impedance:** Over 10k $\Omega$

**Sampling Frequency:** 50kHz

**Sampling System:** 12 bit quantizing system plus analog logarithmic compression

**Residual Noise:** Below –100dBm

(IHF-A, Level Switch: –20dBm)

**Controls:** Pre delay Time (0.5–35ms)

Modulation Rate (0.1–14Hz)

Modulation Depth

Effect Equalizer

Effect Level

**Switches:** Power (On/Off)

Effect (On/Off)

Level (–20dBm/–10dBm)

**Indicators:** Power

Effect

**Jacks:** Input (Standard, Pin)

Output A (Standard, Pin)

Output B (Standard, Pin)

Effect Remote (On/Off)

AC Adaptor (In/Out)

**Power Source:** 9V DC

(BOSS PSA-120, 220, 240 or RPW-7)

**Current Draw:** 80mA

**Dimensions:** 218(W) x 169(D) x 44(H)mm/

8<sup>9</sup>/<sub>16</sub>" x 6<sup>1</sup>/<sub>16</sub>" x 1<sup>3</sup>/<sub>4</sub>"

**Weight:** 900g/2 lb

**Accessories:** DC Cord (0.5m), Rubber Feet (x 4)

**OPTIONS**

AC Adaptor BOSS PSA-120, 220 or 240

Power Supply BOSS RPW-7

Rack Mount Adaptor RAD-10

Footswitch FS-1

**\* Specifications are subject to change without notice.**



10431

RCE-10

UPC

10431



1991

### BOSS Micro Studio Series

RCL-10	Compressor/Limiter
RBF-10	Flanger
RGE-10	Graphic Equalizer
RPQ-10	Preamplifier/
	Parametric Equalizer
RPH-10	Phaser
RDD-20	Digital Delay
RSD-10	Digital Sampler/Delay
RPS-10	Digital Pitch Shifter/ Delay
RCE-10	Digital Chorus Ensemble
RPW-7	Power Supply

**BOSS**

Products of Roland

RCE-10 Instructions Printed in Japan Aug. '86 C3