

**Roland**

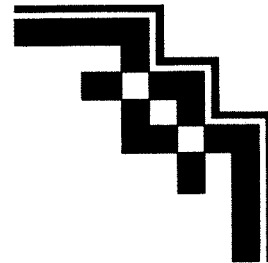

Digital Sequencer  
And Sound Module

# MT 120

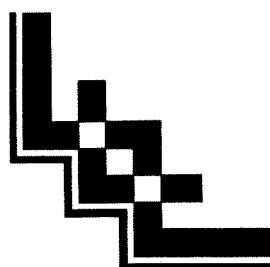

OWNER'S MANUAL

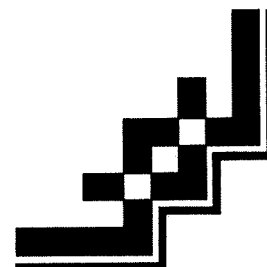

## Information

When you need repair service, call your local Roland Service Station or the authorized Roland distributor in your country as shown below.

### U. S. A.

**Roland Corporation US**  
7200 Dominion Circle  
Los Angeles, CA. 90040-  
3696, U. S. A.  
TEL: (213) 685-5141

### CANADA

**Roland Canada Music Ltd.**  
(Head Office)  
5480 Parkwood Way  
Richmond B. C., V6V 2M4  
CANADA  
TEL: (604) 270-6626

**Roland Canada Music Ltd.**

(Montreal Office)  
9425 Transcanadienne  
Service Rd. N., St Laurent,  
Quebec H4S 1V3, CANADA  
TEL: (514) 335-2009

**Roland Canada Music Ltd.**

(Toronto Office)  
346 Watline Avenue,  
Mississauga, Ontario L4Z  
1X2, CANADA  
TEL: (416) 890-6488

### AUSTRALIA

**Roland Corporation Australia Pty. Ltd.**  
38 Campbell Avenue  
Dee Why West. NSW 2099  
AUSTRALIA  
TEL: (02) 982-8266

### NEW ZEALAND

**Roland Corporation (NZ) Ltd.**  
97 Mt. Eden Road, Mt. Eden,  
Auckland 3, NEW ZEALAND  
TEL: (09) 3098-715

### UNITED KINGDOM

**Roland (U.K.) Ltd.**  
Rye Close Ancells Business  
Park Fleet, Hampshire GU13  
8UY, UNITED KINGDOM  
TEL: 0252-816181

**Roland (U.K.) Ltd.,  
Swansea Office**

Atlantic Close, Swansea  
Enterprise Park, Swansea,  
West Glamorgan SA79FJ,  
UNITED KINGDOM  
TEL: (0792) 700-139

### ITALY

**Roland Italy S. p. A.**  
Viale delle Industrie 8 20020  
ARESE MILANO ITALY  
TEL: 02-93581311

### SPAIN

**Roland Electronics de España, S. A.**  
Calle Bolivia 239 08020  
Barcelona, SPAIN  
TEL: 93-308-1000

### GERMANY

**Roland Elektronische Musikinstrumente Handelsgesellschaft mbH.**  
Oststrasse 96, 2000  
Norderstedt, GERMANY  
TEL: 040/52 60 090

### FRANCE

**Musikengro**  
102 Avenue Jean-Jaures  
69007 Lyon Cedex 07  
FRANCE  
TEL: (7) 858-54 60

**Musikengro (Paris Office)**

Centre Region Parisienne 41  
rue Charles-Fourier, 94400  
Vitry SUR/SEINE FRANCE  
TEL: (1) 4680 86 62

### BELGIUM/HOLLAND/ LUXEMBOURG

**Roland Benelux N. V.**  
Houtstraat 1 B-2260 Oevel-  
Westerlo BELGIUM  
TEL: (0032) 14-575811

### DENMARK

**Roland Scandinavia A/S**  
Langebrogade 6 Box 1937  
DK-1023 Copenhagen K.  
DENMARK  
TEL: 31-95 31 11

### SWEDEN

**Roland Scandinavia A/S**  
Danvik Center 28 A, 2 tr.  
S-131 30 Nacka SWEDEN  
TEL: 08-702 00 20

### NORWAY

**Roland Scandinavia Avd.  
Kontor Norge**  
Lilleakerveien 2 Postboks 95  
Lilleaker N-0216 Oslo 2  
NORWAY  
TEL: 22-73 00 74

### FINLAND

**Fazer Musik Inc.**  
Länsituulentie POB 169,  
SF-02101 Espoo FINLAND  
TEL: 0-43 50 11

### SWITZERLAND

**Musitronic AG**  
Gerberstrasse 5, CH-4410  
Liestal, SWITZERLAND  
TEL: 061/921 16 15

**Roland CK (Switzerland)  
AG**

P.O.Box Landstrasse 5  
CH-4452 Itingen (BL)  
SWITZERLAND  
TEL: (61) 971 80 80  
Repair Service by Musitronic AG

### AUSTRIA

**E. Dematte & Co.**  
Neu-Rum Siemens-Strasse 4  
6021 Innsbruck P.O.Box 83  
AUSTRIA  
TEL: (0512) 26 44 260

### GREECE

**V. Dimitriadis & Co. Ltd.**  
20, Alexandras Avn., GR  
10682 Athens, GREECE  
TEL: 01-8232415

### PORTUGAL

**Casa Caius Instrumentos Musicais Lda.**  
Rua de Santa Catarina 131  
4000 Porto, PORTUGAL  
TEL: 02-38 44 56

### HUNGARY

**Intermusica Ltd.**  
Warehouse Area 'DEPO'  
Torokbalint, Budapest  
HUNGARY  
TEL: (1) 1868905

### ISRAEL

**D.J.A. International Ltd.**  
11 Bar Gylora St., Tel Aviv  
ISRAEL  
TEL: 972-3-5283329

### CYPRUS

**Radex Sound Equipment Ltd.**  
17 Diagonou St., P.O.Box  
2046, Nicosia CYPRUS  
TEL: 453426, 466423

### U.A.E

**Zak Electronics & Musical Instruments Co.**  
P.O. Box 8050  
DUBAI, U.A.E  
TEL: 695774

### SAUDI ARABIA

**Omar Badoghaish Trading Corp.**  
P.O. Box 5980  
Jeddah, SAUDI ARABIA  
TEL: 966-02-6607038

### KUWAIT

**Easa Husain Al-Yousifi**  
P.O. Box 126 Safat 13002  
KUWAIT  
TEL: 965-5719499

### LEBANON

**A. Chahine & Fils**  
P.O. Box 16-5857  
Beirut, LEBANON  
TEL: 335799

### TURKEY

**Barkat Sanayi ve Ticaret**  
Siraselviler Cad. 86/6 Taksim  
Istanbul, TURKEY  
TEL: 149 93 24

### EGYPT

**Al Fanny Trading Office**  
9, Ebn Hagar Ai Askalani  
Street, Ard El Golf,  
Heliopolis, Cairo, 11341  
EGYPT  
TEL: 2917803-665918

### QATAR

**Badie Studio & Stores**  
P.O.Box 62,  
DOHA Qatar  
TEL: 974 423554

### BAHRAIN

**Moon Stores**  
Bad Al Bahrain Road,  
P.O.Box 20077  
State of Bahrain  
TEL: (0973) 211 005

### BRAZIL

**Roland Brasil Ltda.**  
R. Alvarenga 591 CEP-05509  
Sao Paulo BRAZIL  
TEL: (011) 210-7266  
Repair Service for Roland and  
Rhodes products

**Oliver do Brasil S.A.**

**Instrumentos Musicais**  
Rua Boturoca. 198/206  
CEP 05586-010 Vila Indiana  
Butanta Sao Paulo-SP BRAZIL  
TEL: (011) 814-1344  
Repair Service for BOSS products

### MEXICO

**Casa Veerkamp, s.a. de c.v.**  
Mesones No. 21 Col. Centro  
MEXICO D.F. 06080  
TEL: (5) 709-3716

**La Casa Wagner de**

**Guadalajara s.a. de c.v.**  
Av. Corona No. 202 S.J.  
C.P.44100 Guadalajara,  
Jalisco MEXICO  
TEL: (36) 13-1414

### VENEZUELA

**Musiland Digital C.A.**  
Av. Francisco De Miranda,  
Centro Parque Cristal, Nivel  
C2 Local 20 Caracas  
VENEZUELA  
TEL: (2)2844497

### PANAMA

**Productos Superiores,  
S.A.**  
Apartado 655 - Panama 1  
REP. DE PANAMA  
TEL: 26-3322

### ARGENTINA

**Instrumentos Musicales S.A.**  
Florida 638  
(1005) Buenos Aires  
ARGENTINA  
TEL: (1)394-4029

### HONG KONG

**Tom Lee Music Co., Ltd.  
Service Division**  
22-32 Pun Shan Street, Tsuen  
Wan, New Territories,  
HONG KONG  
TEL: 415-0911

### KOREA

**Cosmos Corporation Service Station**  
261 2nd Floor Nak-Won  
Arcade Jong-Ro ku, Seoul,  
KOREA  
TEL: (02) 742 8844

### SINGAPORE

**Swee Lee Company**  
BLOCK 231,  
Bain Street #03-23  
Bras Basah Complex,  
Singapore 0718  
TEL: 3367886

### PHILIPPINES

**G.A. Yupangco & Co. Inc.**  
339 Gil J. Puyat Avenue  
Makati, Metro Manila 1200,  
PHILIPPINES  
TEL: 02 (817) 0013

### THAILAND

**Theera Music Co., Ltd.**  
330 Verng Nakorn Kasem,  
Soi 2, Bangkok 10100,  
THAILAND  
TEL: 2248821

### VIETNAM

**Saigon Music Distributor**  
383A Dien Bien Phu St.  
3rd. District  
Ho Chi Mink City, Vietnam  
TEL: 84-8-391395/332674

### MALAYSIA

**Syarikat Bentley**  
No.142, Jalan Bukit Bintang  
55100 Kuala Lumpur,  
MALAYSIA  
TEL: (03) 2443333

### INDONESIA

**PT Citrarama Belantika**  
Jl Alaydrus 84 B  
Jakarta 10130  
INDONESIA  
TEL: (021) 3802638,  
3802639

### TAIWAN

**Siruba Enterprise (Taiwan) Co., LTD.**  
Room. 5, 9fl. No. 112 Chung  
Shan N.Road Sec.2 Taipei,  
TAIWAN, R.O.C.  
TEL: (02) 571-5860

### SOUTH AFRICA

**That Other Music Shop (PTY) Ltd.**  
11 Melle Street (Cnr Melle  
and Jula Street)  
Braamfontein 2001  
Republic of South Africa  
TEL: 27 11 403-4105

**Paul Bothner (PTY) Ltd.**

17 Werdmuller Centre  
Claremont 7700  
Republic of South Africa  
TEL: 021-64-4030

As of Jun. 28. 1993

# Roland

# MT 120

Digital Sequencer  
And Sound Module

IBM PC is a registered trademark of the International Business  
Machines Corporation.

Macintosh is a registered trademark of Apple Computer, Inc.

DaynaFile is a trademark of Dayna Communications Inc.

---

**Copyright © 1993 by Roland Corporation**

All rights reserved. No part of this publication may be reproduced  
in any form without the written permission of Roland Corporation.

---

# Contents

Panel Description.....	4
Accessories .....	4
Control Functions.....	5
Introduction .....	6
About this Manual.....	6
MT-120 Features .....	7
With the MT-120, You Can.....	7
Basic Precautions .....	8
Using Disks .....	9
Inserting a Disk.....	9
Removing a Disk .....	9
Write Protecting Your Disks .....	9
Floppy Disks: Handle with Care .....	9
<b>1. Operating the MT-120.....</b>	<b>11</b>
<b>1. Making the Connections .....</b>	<b>12</b>
<b>2. Turning the Power ON.....</b>	<b>13</b>
<b>3. Listening to a Song on Disk.....</b>	<b>14</b>
Inserting the Disk.....	14
Selecting a Song .....	14
Starting Play .....	15
Stopping Playback .....	15
Start/Stop Using the Pedal .....	15
Starting Playback Again from the Beginning .....	16
Starting Playback from the Middle of the Song .....	16
Transposing the Key of the Song.....	16
<b>4. Playing Along with a Song on the Disk .....</b>	<b>17</b>
Selecting a Song .....	17
Adjusting the Tempo.....	17
Right Hand Practice (Mute the Right Hand Part) ....	18
Left Hand Practice (Mute the Left Hand Part) .....	18
Going Back to the Original Tempo.....	19
Playing without Tempo Changes (Tempo Mute)....	19
Playing Along with the Metronome.....	19
About the Count-In .....	20
Practice the same Section Over and Over (Repeat Play).....	21
<b>5. Recording Along with a Song on the Disk.....</b>	<b>22</b>
Recording the Right Hand .....	22
Redoing a Recording .....	23
Recording the Left Hand.....	24
Listening to the Song You have just Recorded.....	24
<b>6. Playing Piano with the MT-120 as Accompaniment .....</b>	<b>25</b>
Select a Song with MT-120 Accompaniment .....	25
Adjust the Volume of the MT-120 .....	25
Music Minus One: Playing the piano part yourself.....	25
<b>7. Recording a New Song.....</b>	<b>26</b>
Calling up a Blank Song .....	26
Recording Along with the Metronome .....	26
Recording without the Metronome Sound .....	28
Recording each Hand Separately.....	28
<b>8. Saving Data onto a Disk.....</b>	<b>29</b>
Formatting a Disk .....	29
Saving to a Disk.....	31
<b>9. Turning the Power OFF.....</b>	<b>32</b>
<b>2. Playing the Sounds of the MT-120 .....</b>	<b>33</b>
<b>1. Tuning the MT-120 to Your Digital Piano (Tune).....</b>	<b>34</b>
MT-120 Tuning .....	34
Tuning Your Digital Piano .....	34
<b>2. Enjoying the Sounds of the MT-120 (Sound) .....</b>	<b>35</b>
Selecting the MT-120's Sounds .....	35
About Part 10 (the Rhythm Part).....	36
Changing the Volume of a Part.....	36
Turning Part Mute On or Off .....	36
When You Want to "Lock in" the Changes for Part Volume .....	37
Returning to the Piano Sound.....	37
<b>3. Recording an Ensemble Song .....</b>	<b>38</b>
Calling Up a Blank Song.....	38
How to Set Up for an Ensemble.....	38
Recording the Drums .....	39
Selecting the Rhythm Part.....	39
Loop Recording .....	40
Recording the Bass.....	42
Selecting the Bass Part.....	42
Recording the Bass Part .....	43
Recording the Chords and Melody.....	43

<b>3. Handy Features.....</b>	<b>45</b>	<b>7. Appendix .....</b>	<b>81</b>
<b>1. Playing Songs on the Disk One After Another</b>		<b>1. Contents of the Demo Song Disk.....</b>	<b>82</b>
<b>(All Song Play).....</b>	<b>46</b>	Profiles of the Demo Song Composers .....	83
<b>2. Changing the Metronome Resolution</b>		<b>2. Selecting Functions.....</b>	<b>84</b>
<b>(Metro Beat).....</b>	<b>47</b>	<b>3. Data List .....</b>	<b>85</b>
<b>3. Marking Places in the Music (Marker A and B).....</b>	<b>48</b>	<b>4. Tone List .....</b>	<b>86</b>
Using the Marker Feature.....	48	<b>5. Troubleshooting.....</b>	<b>91</b>
How to Set a Marker.....	48	<b>6. Messages .....</b>	<b>92</b>
Setting Marker Resolution .....	49		
How to Set a Marker.....	49	<b>MIDI Implementation Chart .....</b>	<b>94</b>
Deleting a Marker.....	50	<b>Specifications .....</b>	<b>96</b>
Jumping to a Marker .....	50	<b>Index .....</b>	<b>97</b>
<b>4. Recording Pickup Notes .....</b>	<b>51</b>	<b>Printed Music for "Minuet".....</b>	<b>99</b>
<b>5. Playing in Sync with Other Instruments .....</b>	<b>52</b>	<b>Playing with Count-In On or Off.....</b>	<b>101</b>
Getting Ready.....	52	<b>Recording with Count-In On or Off .....</b>	<b>102</b>
Synchronized Play .....	52		
Starting and Stopping Playing			
on Other Instruments.....	53		
Ending Synchronized Play.....	53		
<b>4. Disk Handling.....</b>	<b>55</b>		
<b>1. Saving a Song onto Disk .....</b>	<b>56</b>		
Saving a Song onto the Disk (Save) .....	56		
Saving it as a New Song (Save As).....	57		
<b>2. Copying a Song on the Disk (Song Copy) .....</b>	<b>59</b>		
<b>3. Copying All the Songs on a Disk (All Song Copy) ....</b>	<b>60</b>		
<b>4. Deleting Songs on a Disk (Song Delete) .....</b>	<b>62</b>		
<b>5. Making Use of Many Kinds of Data .....</b>	<b>63</b>		
<b>1. ism music data (3.5-inch Disks).....</b>	<b>64</b>		
<b>2. Standard MIDI Files.....</b>	<b>65</b>		
<b>3. Trying Minus One Play .....</b>	<b>67</b>		
Using an Electronic Piano to play			
the MT-120's internal sound source.....	67		
Using a Guitar or Keyboard			
(with its own sound source) .....	69		
<b>6. MT-120 MIDI Information .....</b>	<b>73</b>		
<b>1. About MIDI .....</b>	<b>74</b>		
<b>2. The MT-120's Sequencer .....</b>	<b>75</b>		
<b>3. The MT-120's GS Sound Source.....</b>	<b>76</b>		
About the Number of Sounds that can be Played			
Simultaneously.....	77		
About Songs made on the MT-120 .....	77		
<b>4. MIDI Diagram of the MT-120.....</b>	<b>78</b>		
<b>5. MIDI Switching (MIDI) .....</b>	<b>79</b>		



# Panel Description

## Front Panel

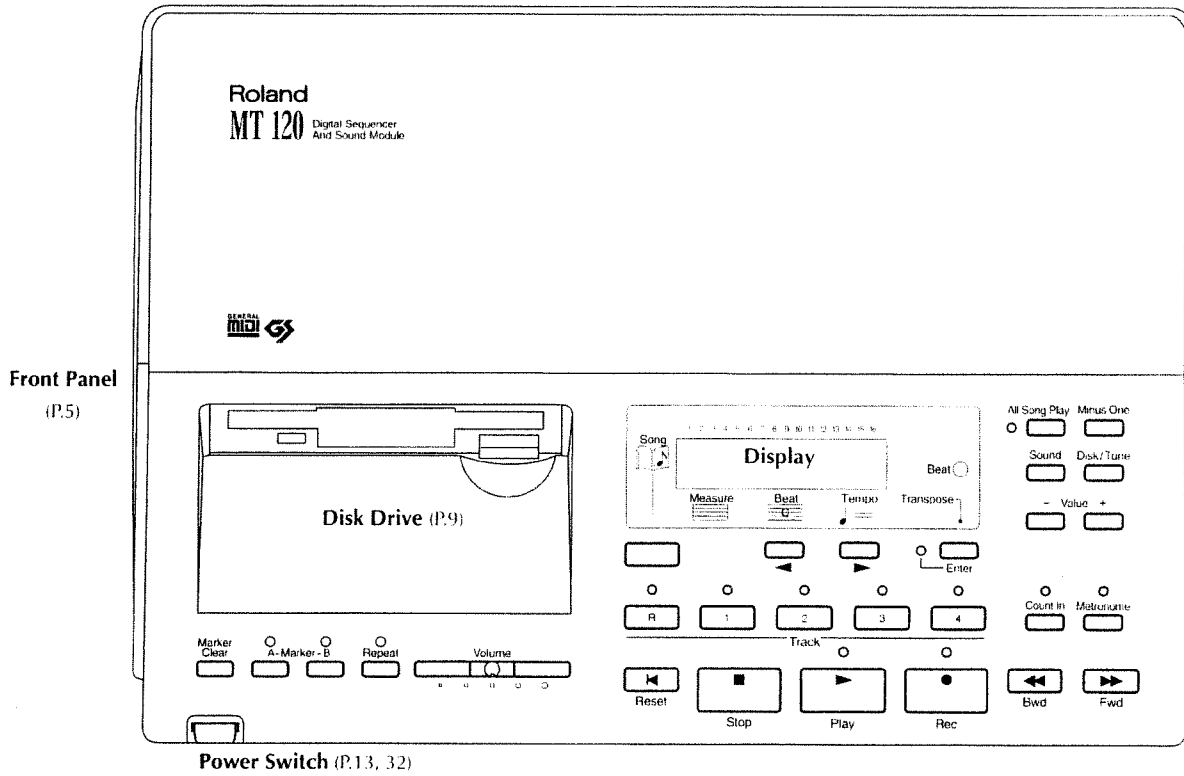

## Rear Panel

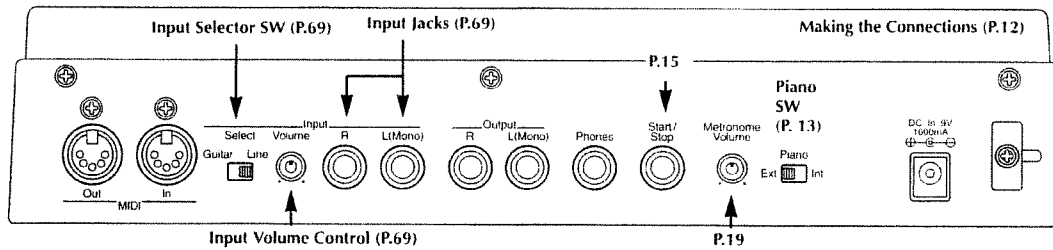

# Accessories

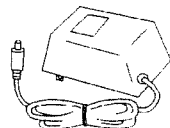

AC adaptor (1)



MIDI cables (2)



Audio cables (1)

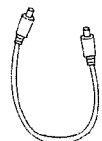

DC/DC cable (1)



Demo Song Disk (1)



Owner's Manual Supplement (1)

# Control Functions

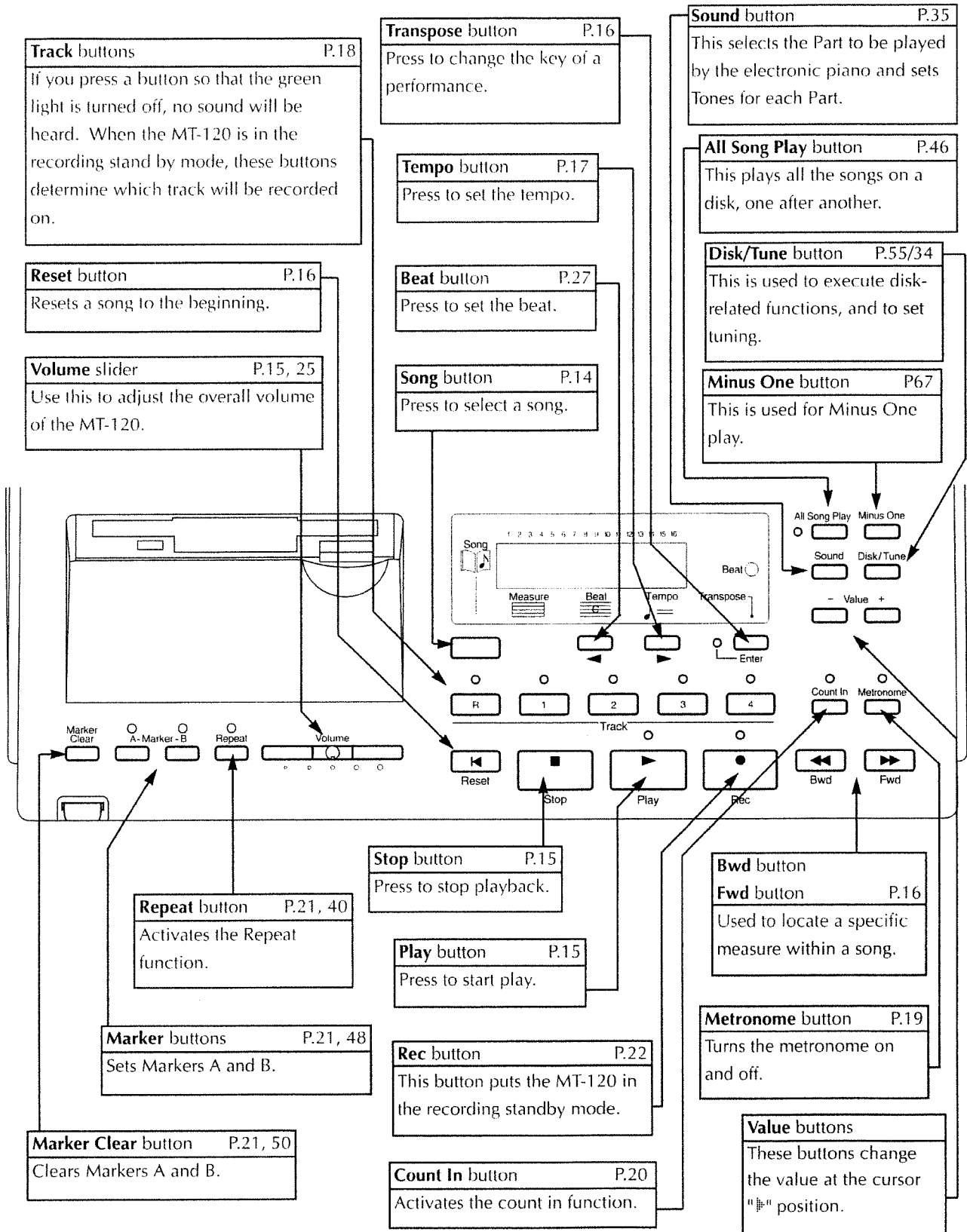

---

# Introduction

We'd like to take a moment to thank you for purchasing the Roland MT-120 Digital Sequencer and Sound Module.

The MT-120 features an easy-to-use 5-track sequencer for recording and playback, as well as a 16-part multi-timbral GS sound source.

## Concerning this Unit's Sound Sources

### •General MIDI System



The General MIDI System is a set of recommendations which seek to provide a way for going beyond the limitations of proprietary designs, and standardize the MIDI capabilities provided by sound generating devices.

If you use a sound generating unit which carries the General MIDI logo, you will be able to faithfully reproduce any song data which also carries the General MIDI logo.

### •GS Format



The GS Format is Roland's universal set of specifications which were formulated in the interest of standardizing the way in which sound generating devices will operate when MIDI is used for the performance of music. If you use a sound generating unit which carries the GS logo, you will be able to faithfully reproduce any commercially available song data which also carries the GS logo.

This unit's sound source supports both General MIDI and GS. Song data which carries either of these logos can be accurately reproduced (when the Piano switch is set to Int) .

The MT-120 was specifically designed for use with a MIDI keyboard, and for Roland Digital Pianos in particular.

\* Roland also offers the MT-200, designed for making data for conductors.

## Concerning the Sequencer in this Unit



This unit is capable of playing "ism music data" (3.5 inch floppy disks).



This unit is capable of playing Standard MIDI Files, such as "SMF Music Data" (720 KB/1.44MB format 3.5 inch floppy disks).

## Concerning the Demo Song Data of this Unit



The data on the demo song disk can be played on any unit that supports "ism music data" (3.5 inch floppy disks).



The song data on the demo song disk is designed to be played on any unit which carries the GS logo.

\* The demo song disk is write-protected. As a result, its content cannot be altered when used with the MT-120.

\* Note also that although you are allowed to make a copy of the data on the demo song disk, no further copies can be made from that copy.

---

# About this Manual

Chapter 1 contains information on how to listen to the songs recorded on the disks and practice along with them on the piano, and how to record your piano songs and save them onto a disk as well. These are the most basic things you'll need to know to operate the MT-120.

With this information, you'll be able to play an amazing variety of sounds on the MT-120. Check out Chapter 2 and later chapters for practical examples of combining these sounds to make ensemble songs and accompaniment, or using song data from other disks, and a wide range of other applications.



---

# MT-120 Features

## Easy to Use

The sequencer is set up to operate like a regular tape recorder. This makes recording and playback easy.

## Five Track Sequencer

You can record and playback using any of five sequencer tracks.

## Handy Features for Practicing

The MT-120 is equipped with a number of convenient features for practicing the piano, such as a Metronome, a Count-In function, and a Repeat Play feature. With Repeat Play, you can practice the same phrase over and over again as many times as you want.

You can also use Minus One play to mute a Part in song data so the recorded Part won't be heard, enabling you to step out and play the part all by yourself!

## Audio Input Jack

The MT-120 has an audio input jack, which means you can plug in a guitar for ensemble play, or mix another sound source with the keyboard, with output through the audio output jack.

## Plays ism music data

With 3.5-inch "ism music data" disks (sold separately), you can listen to, and practice along with, a variety of popular tunes.

## Plays Standard MIDI Files Too

You can play back Roland's SMF Music Data and data in Standard MIDI File format designed for playing a GS sound source. When you do this, the SMF Music Data is converted to the data format for the MT-120, allowing it to be recorded and saved as song data for the MT-120.

## GS Sound Source

The MT-120 has a built-in sound source that conforms to Roland's newly developed GS Format. Essentially what this means is that different sound sources (keyboards or sound modules) that conform to the GS Format will all play the same song data in the same way and respond to the same MIDI messages in a fairly uniform manner.

The MT-120 has sixteen sound parts. You can select from 226 high-quality instrumental sounds to play up to 15 parts, and from 8 different drum sets or 1 SFX set for the rhythm part (part number 10).

---

# With the MT-120, You Can...



...record your playing!

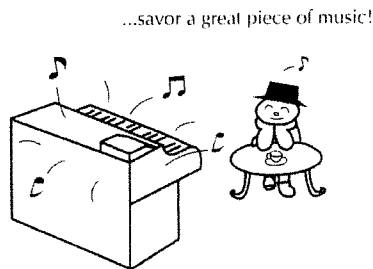

...savor a great piece of music!

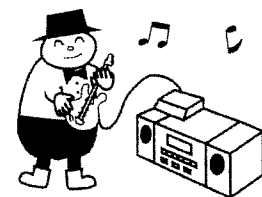

You can use Minus One play with the guitar.



...practice one hand at a time!

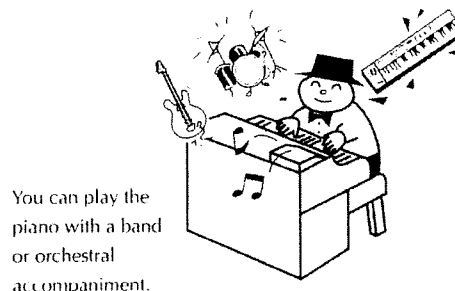

You can play the piano with a band or orchestral accompaniment.

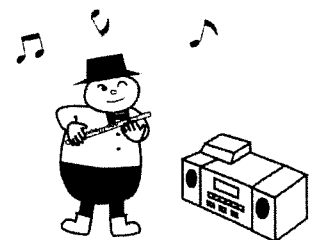

You can play an acoustic instrument with an orchestral accompaniment.

---

# Basic Precautions

## Power Supply

- \* Be sure to use only the adaptor supplied with the unit. Use of any other power adaptor could result in damage, malfunction, or electric shock.
- \* When making any connections with other devices, always turn off the power to all equipment first; this will help prevent damage or malfunction.
- \* Do not use this unit on the same power circuit with any device that will generate line noise, such as a motor or variable lighting system.
- \* The power supply required for this unit is shown on its nameplate. Ensure that the line voltage of your installation meets this requirement.
- \* Avoid damaging the power cord; do not step on it, place heavy objects on it, etc.
- \* When disconnecting the AC adaptor from the outlet, grasp the plug itself; never pull on the cord.
- \* If the unit is to remain unused for a long period of time, unplug the power cord.

## Placement

- \* Do not subject the unit to temperature extremes (eg. direct sunlight in an enclosed vehicle). Avoid using or storing the unit in dusty or humid areas or areas that are subject to high vibration levels.
- \* Using the unit near power amplifiers (or other equipment containing large transformers) may induce hum.
- \* This unit may interfere with radio and television reception. Do not use this unit in the vicinity of such receivers.
- \* Observe the following when using the unit's disk drive. For further details refer to Using Disks (P. 9).
  - Do not place the unit near devices that produce a strong magnetic field (eg. loudspeakers).
  - Do not move the unit or subject it to vibration while it is operating.
  - Install the unit on a solid, level surface in an area free from vibration. If the unit must be installed at an angle, be sure that the angle of installation falls within the tolerance range (upward; 15°; downward; 5°).
  - Avoid using the drive in areas of high humidity (eg. condensation). High levels of moisture can adversely affect the operation of the drive and/or damage disks. When the unit has been transported, allow it to warm to room temperature before operating.

- \* Do not expose the unit to temperature extremes or install it near devices that radiate heat. Direct sunlight in an enclosed vehicle can deform or discolor the unit.

## Maintenance

- \* For everyday cleaning wipe the unit with a soft, dry cloth (or one that has been slightly dampened with water). To remove stubborn dirt, use a mild, neutral detergent. Afterwards, be sure to wipe the unit thoroughly with a soft, dry cloth.
- \* Never use benzene, thinners, alcohol or solvents of any kind, to avoid the risk of discoloration and/or deformation.

## Memory Backup

- \* The unit contains a battery which maintains the contents of memory while the main power is off. The expected life of this battery is 5 years or more. However, to avoid the unexpected loss of memory data, it is strongly recommended that you change the battery every 5 years.
- \* When the battery becomes weak, the following message will appear in the display: "Battery Low!". Please change the battery as soon as possible to avoid the loss of memory data.

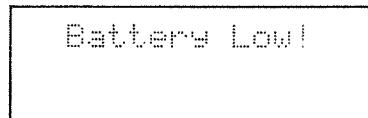

## Additional Precautions

- \* Protect the unit from strong impact.
- \* Do not allow objects or liquids of any kind to penetrate the unit. In the event of such an occurrence, discontinue use immediately. Contact qualified service personnel as soon as possible.
- \* Never strike or apply strong pressure to the display.
- \* Should a malfunction occur (or if you suspect there is a problem) discontinue use immediately. Contact qualified service personnel as soon as possible.
- \* A small amount of noise may be heard from the display, and thus should be considered normal.
- \* To prevent the risk of electric shock, do not open the unit or its AC adaptor.

# Using Disks

The MT-120 uses 3.5-inch 2HD or 2DD floppy disks (sometimes called "microflops"). They are used to store the songs you record on the MT-120. (See page 29, 56)

Whenever possible, use 2HD disks. This is because the data access speed of a 2DD disk is somewhat slower than that of a 2HD, and this may on rare occasions cause playback errors.

## 1. Inserting a Disk

To insert a disk, push it firmly (but gently) into the drive; label side up — it will click into place.

\* Make sure the disk is correctly inserted before trying to use it.

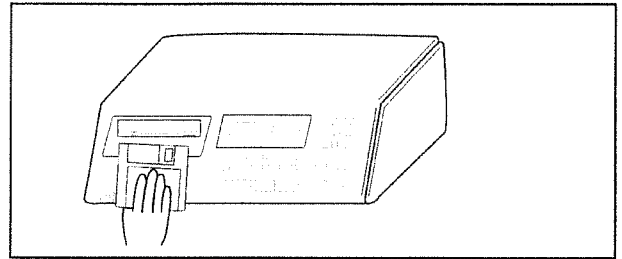

## 2. Removing a Disk

To remove a disk, press the EJECT button firmly.

\* When the power is on, the disk drive light will alternate between being dimly lit (disk drive ready) and brightly lit (disk drive in operation). In the latter case, do not try to eject the disk or you might damage the magnetic disk surface and make the disk unusable.

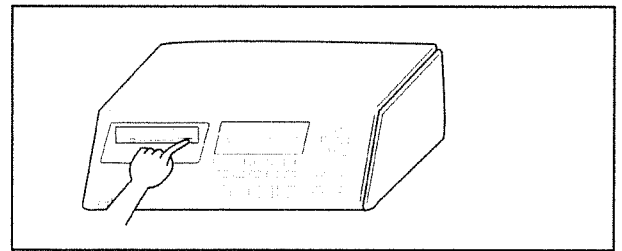

## 3. Write Protecting Your Disks

Floppy disks contain a 'write protect' tab which can protect the disk from accidental erasure.

It is recommended that the tab be kept in the 'protect' position and moved to the 'write' position only when you wish to write new data onto the disk.

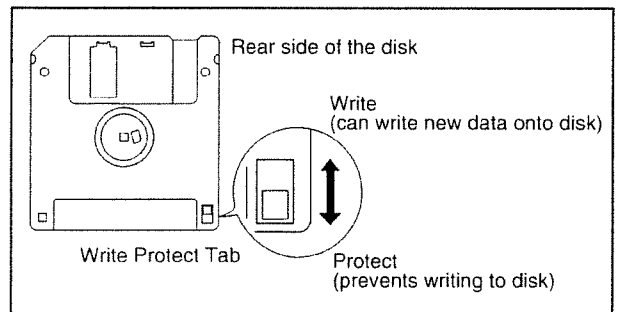

## 4. Floppy Disks: Handle with Care

\* Floppy disks contain a plastic disc coated with magnetic particles; this is the magnetic storage medium for all data. Observe the following when handling disks:

\* Never touch the coated surface of the floppy's internal disc.

\* Do not subject floppy disks to temperature extremes (eg., direct sunlight in an enclosed vehicle). Recommended temperature range: 10 to 50°C.

\* Do not expose floppy disks to strong magnetic fields, such as those generated by loudspeakers.

\* Do not use or store in extremely dusty places.

\* Remove disks from the disk drive before turning the MT-120 on or off.

\* All important data should be copied onto backup disk(s). This provides a complete duplicate of the data should the original disk(s) be lost or damaged.

\* The identification label should be firmly fixed to the disk. Should the label come loose while the disk is in the drive, it may be difficult to remove the disk.

---

# MEMO

## 1

# Operating the MT-120

<b>1. Making the Connections</b> .....	12	<b>5. Recording Along with a Song on the Disk</b> .....	22
<b>2. Turning the Power ON</b> .....	13	Recording the Right Hand .....	22
<b>3. Listening to a Song on Disk</b> .....	14	Redoing a Recording .....	23
Inserting the Disk.....	14	Recording the Left Hand.....	24
Selecting a Song .....	14	Listening to the Song You have just Recorded .....	24
Starting Play .....	15	<b>6. Playing Piano with the MT-120 as Accompaniment</b> .25	
Stopping Playback .....	15	Select a Song with MT-120 Accompaniment .....	25
Start/Stop Using the Pedal .....	15	Adjust the Volume of the MT-120 .....	25
Starting Playback Again from the Beginning .....	16	Music Minus One: Playing the piano part yourself.25	
Starting Playback from the Middle of the Song ....	16	<b>7. Recording a New Song</b> .....	26
Transposing the Key of the Song.....	16	Calling up a Blank Song .....	26
<b>4. Playing Along with a Song on the Disk</b> .....	17	Recording Along with the Metronome .....	26
Selecting a Song .....	17	Recording without the Metronome Sound .....	28
Adjusting the Tempo.....	17	Recording each Hand Separately .....	28
Right Hand Practice (Mute the Right Hand Part) ....	18	<b>8. Saving Data onto a Disk</b> .....	29
Left Hand Practice (Mute the Left Hand Part) .....	18	Formatting a Disk .....	29
Going Back to the Original Tempo .....	19	Saving to a Disk.....	31
Playing without Tempo Changes (Tempo Mute)....	19	<b>9. Turning the Power OFF</b> .....	32
Playing Along with the Metronome .....	19		
About the Count-In .....	20		
Practice the same Section Over and Over			
(Repeat Play) .....	21		

# 1. Making the Connections

In this section we'll show you how to connect the MT-120 to your digital piano. When making connections, be sure that both units are turned off.

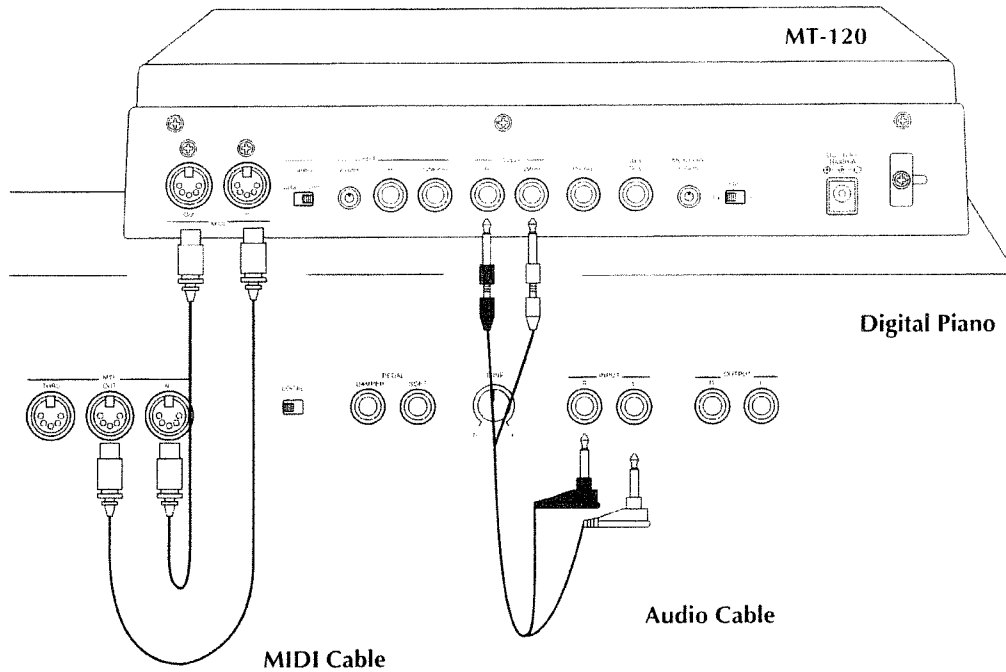

## MIDI Cable Connection

Connect the MIDI OUT of your digital piano to the MIDI IN of the MT-120. Then connect the MIDI IN of your piano to the MIDI OUT of the MT-120.

## Audio Cable Connection

Using the supplied audio cable, connect the L and R OUTPUTS of the MT-120 to the appropriate L and R INPUTS on the piano.

If you are using a digital piano without Audio In, connect the MT-120 to the INPUT of a keyboard amplifier or mixer.

When nothing is connected to the MT-120's INPUT jacks, turn the INPUT Volume control all the way counterclockwise.

## Headphone Connection

If the MT-120 is connected to a digital piano with an audio cable, plug the headphones into the piano's PHONES jack. In other cases, plug the headphones into the PHONES jack on the back of the MT-120.

## AC Adaptor Connection

Connect the appropriate end of the AC Adaptor to the DC IN 9V jack. Connect the other end to a standard AC outlet.

Loop the power cable around the special cord hook on the back of the unit to help prevent the adaptor from accidentally being unplugged in the middle of a performance.

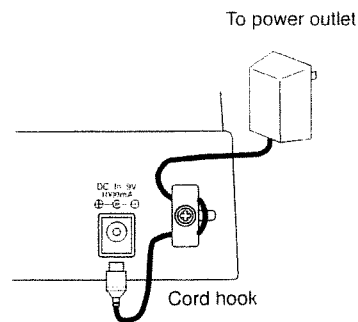

If you are using a Roland Piano with a DC OUT connector, connect the DC In of the MT-120 to the DC OUT using the DC/DC cable.

## 2. Turning the Power ON

After checking to see that you've connected everything correctly;

### (1) Turn the piano on.

Be sure to turn the piano on first!

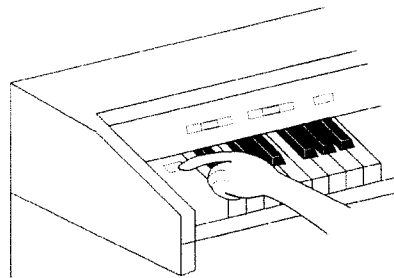

### (2) Turn on the MT-120.

The MT-120's display will indicate that a new song is ready to be recorded.

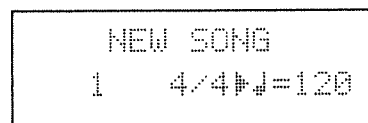
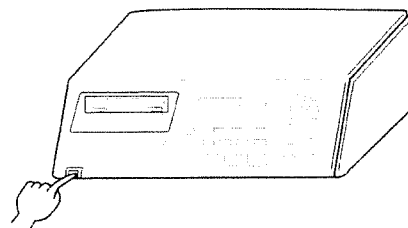

### Switching Piano Sounds

When playing a piano piece on the MT-120, you have the choice of using your piano's internal sound (Ext) or the MT-120's own internal piano sound (Int).

**You can change this setting with the switch marked Piano on the rear panel of the MT-120.**

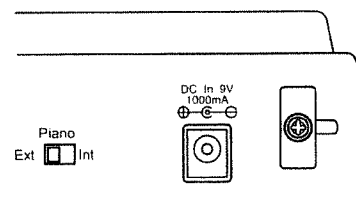

### Setting the Send/Receive Channel on the Piano to 1

If you have set the switch to Ext, but still can't get the piano tone from your keyboard to sound, it may be that the send/receive channel on the piano is not set to Channel 1.

\* If you are using a Roland piano, the way to select channel 1 is to simultaneously press the [FUNCTION] ([MIDI]) button and the leftmost key on the keyboard, as shown opposite.

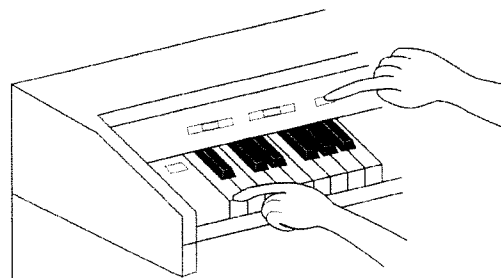

# 3. Listening to a Song on Disk

It's easy to listen to a song recorded on a disk: just insert the disk into the drive, select the Song you want to hear by pressing the Value buttons, and then press the Play button.

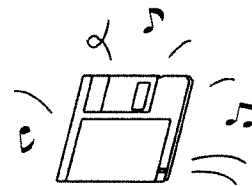

## Inserting the Disk

(1) Insert the disk into the disk drive.

This time around, we'll listen to one of the songs on the Demo Song Disk that came with your MT-120.

\* The disk contains ten demo songs. For details on each, see page 82.

The title of the first song on the disk will appear in the display.

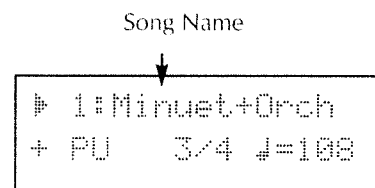
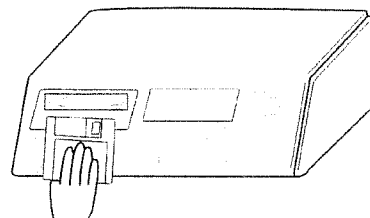

This indication is called the 'Play screen'.

## Selecting a Song

(2) By pressing the [Value -] and [Value +] buttons, the display will change to show the name of the next song on the disk.

In this example, we'll select the piano piece called "Minuet."

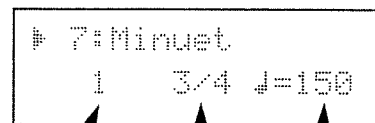
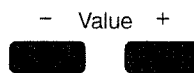

Measure Number      Time Signature      Tempo

### NOTE!

**Never try to remove a disk from the drive while the drive light is brightly lit.**

When the power is on, the disk drive light will alternate between being dimly lit (disk drive ready) and brightly lit (disk drive in operation). In the latter case, do not try to eject the disk or you might damage the magnetic disk surface and make the disk unusable.

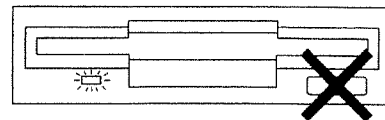

\* If the ▶ symbol is not located just to the left of the Song Name, press the [Song] button, and then press the [Value -] and [Value +] buttons to make your selection.



This symbol will move to here

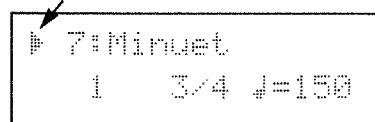



## Starting Play

- (3) Press the [Play] button to start playback of the song. The light on the [Play] button lights up.

### Adjusting the Volume

Adjust the volume of the piano sound using your piano's volume control.

- \* If the sound is coming from the MT-120 itself (i.e., the Piano switch is set to Int), you would adjust the volume using the MT-120's volume slider.

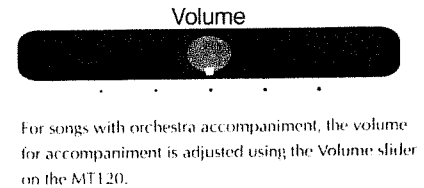
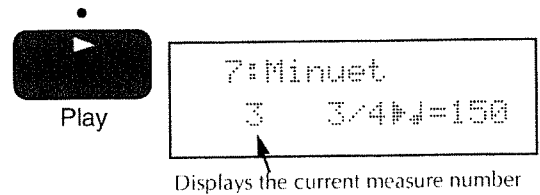

## Stopping Playback

- (4) Press the [Stop] button to stop playback of the song. The light on the [Play] button goes out.

- \* A "+" sign (just before the measure number in the display) indicates that play was stopped in the middle of that measure.

- \* You can repeat the song over and over again. Press the [Repeat] button so that the light is on.

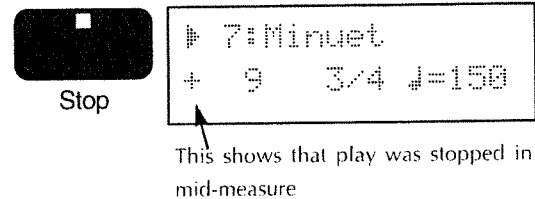

## Start/Stop Using the Pedal

With an optional DP-2 pedal, you can start and stop playback (and recording) in a way similar to using the [Play] and [Stop] buttons.

- (1) The DP-2 plugs into the Start/Stop jack on the rear panel of the MT-120.
- (2) Press the pedal once with your foot to start playback.
- (3) Press it again to stop playback.

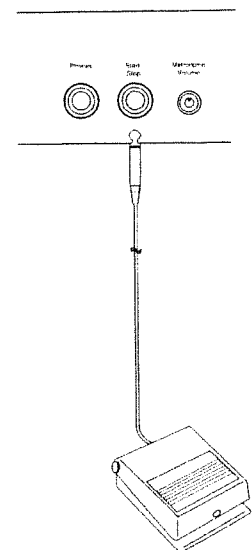

### Starting Playback Again from the Beginning

(1) Press the [Reset] button. The measure number will reset to 1.

\* For songs that begin with a few pickup notes before the first bar, the display will read "PU," indicating that you're starting from the very first note of the song.

(2) Press [Play] again.



Reset

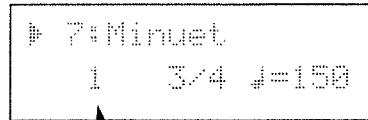

Returns all the way back to measure 1



Play

### Starting Playback from the Middle of the Song

(1) Press the [Bwd] and [Fwd] buttons to locate the measure number where you wish playback to continue from.

\* Holding down either button will cause the measure number to change continuously.

\* The buttons still function during playback.

\* If the light above the [Repeat] button is on, you can locate the repeat section (from Marker A to B).

(2) Press the [Play] button.



Bwd

Fwd

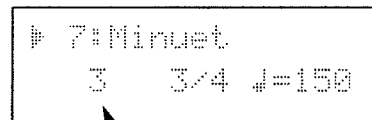

Playback will start from this measure number

\* When playing ism music data or a Standard MIDI file, the message "Please Wait..." may appear on the screen.



Play

### Transposing the Key of the Song

(1) Press the [Transpose] button.

(2) Press the [Value -] and [Value +] buttons to change the key.

\* Each unit of the TRANSPOSE function corresponds to an interval of a semi-tone, and you can change the key up or down a maximum of 12 semi-tones (one octave). So, for example, if you wanted a song that was written in the key of D to play in the key of E, set Transpose to 2 using the [Value -] and [Value +] buttons.

\* If transposed too high or too low, the result may be beyond the range of playable sounds, and the song may not play normally.

(3) Press [Transpose] one more time. The Play screen display will return.

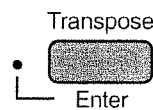

Enter

- Value +

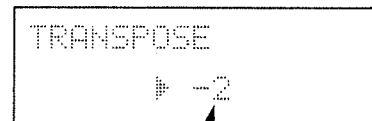

Changes the key signature

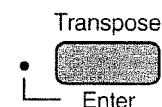

Enter

\*The Data in the Rhythm Part will not be transposed.

## 4. Playing Along with a Song on the Disk

Using the Mute feature, you can turn off one part of a piano piece recorded on a disk and play that part yourself!

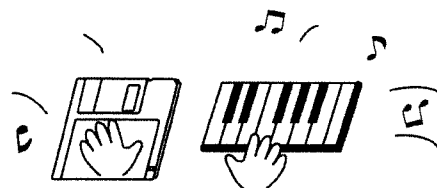

### Selecting a Song

Try playing through a little of the "Minuet" (the printed music is included at the back of this manual).

- (1) Insert the Demo disk into the disk drive, and by pressing the [Value -] and [Value +] buttons, select "Minuet".

- Value +

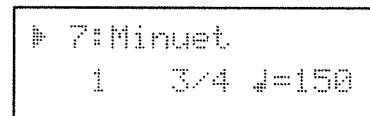

### Adjusting the Tempo

The "Minuet" is marked "allegretto", so it plays at a fast tempo.

Since it is probably too difficult to play the piece at this tempo when just starting out, adjust the tempo to one suitable for practice.

- (1) Press the [Play] button.



Play

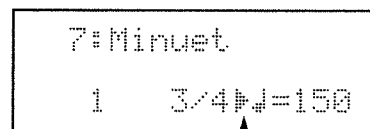

Tempo



If there is no symbol here, press the [Tempo] button.



- (2) Press the [Value -] and [Value +] buttons to select a tempo suitable for practice.

- Value +

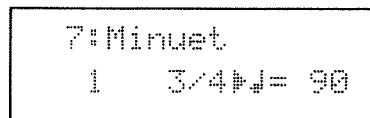

- (3) Press the [Stop] button.



Stop

## Right Hand Practice (Mute the Right Hand Part)

This song has the left hand piano part recorded on Track 3, and the right hand part on Track 4. So here's the plan: turn off Track 4 (the right hand part) and play it yourself on the piano! ("Music Minus One")

- (1) Press the [Count In] button, and the button's indicator will light up. This lets you hear an audible two-measure count before the song starts playing.
- (2) Press the [Reset] button to reset the song to the beginning.
- (3) Press the Track 4 button so that the green light is turned off (mute). The right hand part will not be heard now.
- (4) Press the [Play] button, and the song "Minuet" will start to play; left hand part only, of course. Try playing the right hand part yourself along with the music.
- (5) When you wish to stop playback, just press the [Stop] button.
- (6) Press the Track 4 button again, and the green light will be turned on again. Track 4 will now be heard.

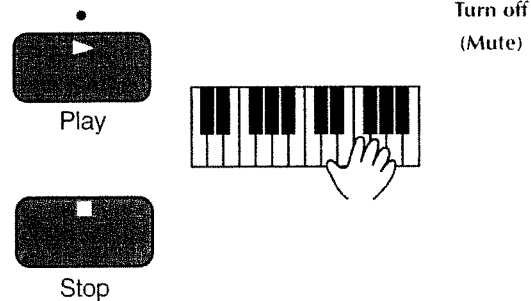
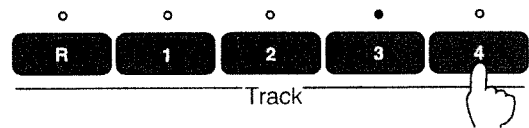
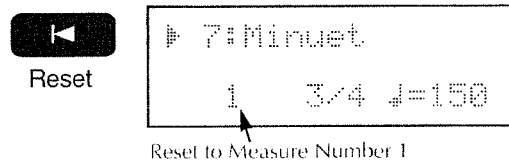
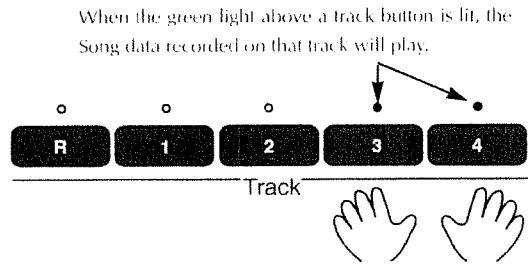

## Left Hand Practice (Mute the Left Hand Part)

Next, let's try the same thing with the left hand. It's the same as for right hand practice, except that in step (3) you press the Track 3 button to turn off the green light. This means that the Track is now Muted (will not sound). When you've finished practicing the left hand part, press the Track 3 button again (to turn on Track 3).

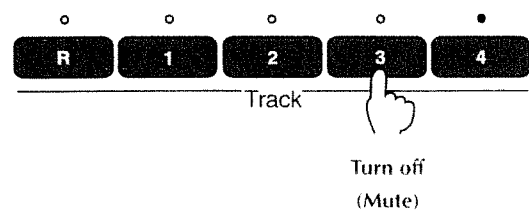

### Going Back to the Original Tempo

- (1) Hold down the [Tempo] button and press [Reset].

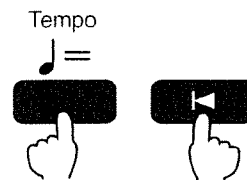

### Playing without Tempo Changes (Tempo Mute)

You can play Songs without any of the changes in tempo that have been made.

- (1) While holding [Tempo], press [Stop].  
Tempo changes are ignored (Tempo Mute).

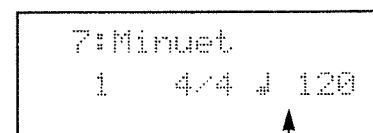
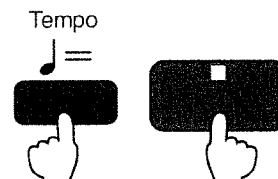

The "=" symbol disappears during Tempo Mute

- To reactivate the changes in tempo, press [Play] while holding down the [Tempo] button.

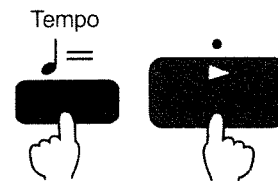

### Playing Along with the Metronome

- (1) Press the [Metronome] button to turn on the light.

The metronome can be heard.

The volume can be adjusted with the **Metronome Volume** control on the rear panel of the unit.



\* Press the [Metronome] button again when you wish to stop the metronome.

\* You can also change the metronome's beat .  
See page 47.

## About the Count-In

If you press the [Count In] button (and the indicator lights), when you press [Play], you'll hear two bars of Count-In phrase (in the correct tempo) before the music starts.

If you start in the middle of a bar, count-in starts at the beginning of the previous measure.

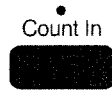

\* Press the Count-In button again if you wish to cancel the count-in.

\* During count-in, the metronome will not be heard.

### When started at the beginning of the fifth bar

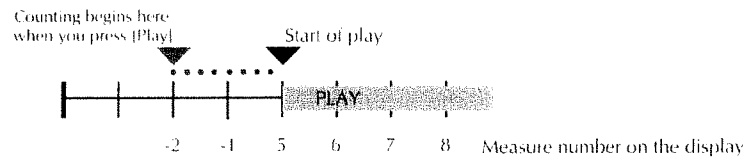

### When started in the middle of the fifth bar

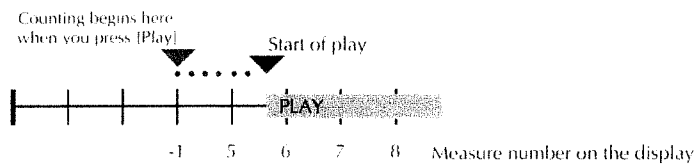

## Practice the same Section Over and Over

### (Repeat Play)

With Repeat Play, you can set Markers at the start and end of a particular phrase you wish to practice. By doing so, you can repeat just that section over and over again.

For example, here we wish to repeat 2 measures from the beginning of the 4th measure.

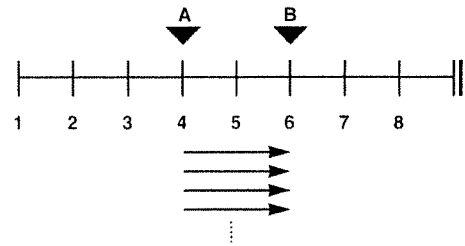

- (1) First, we'll set markers at the start and end of the play range.

Press the [Fwd] and [Bwd] buttons as needed until you see "4" in the measure number display. Then press [Marker A].

Because we wish to repeat 2 measures (from the beginning of the 4th measure), press [Fwd] and [Bwd] until a "6" appears in the measure number display. Then press [Marker B].

\* If you just want to repeat a song all the way through, you can skip this step. Leave both marker buttons the way they are (lights are off).

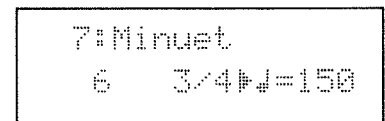
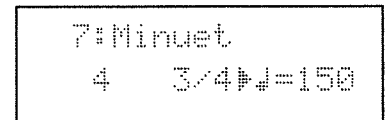

- (2) Press the [Repeat] button, and the light will be turned on. You will automatically jump to Marker A.

- (3) Press [Play].

The music starts, and when it reaches Marker B, it returns to Marker A, and repeats the section between the markers.

\* Repeat cannot be turned on or off during play.

- (4) Press [Stop] to stop playback of the section.

\* You must delete an old marker before you can set a new one. To do this, press the button for the Marker (A or B) that you wish cleared while holding down [Marker Clear].

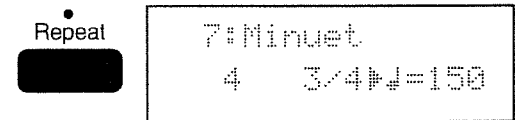

\* Pressing the [Repeat] button a second time will turn off the Repeat function.



To delete a Marker...

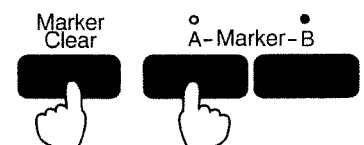

## 5. Recording Along with a Song on the Disk

In this section, we'll try recording one part (one hand) of a song while the MT-120 plays the other.

### Recording the Right Hand

Take a look again at the printed music for "Minuet" (at the back of this manual). The piece is divided into two parts; one to be played by the right hand and one by the left.

- (1) Press [Reset] to move to the beginning of the song.



- (2) Press the Track 4 button, and the light will be turned off. This means that you will hear only the left hand part of the Demo Song being played.

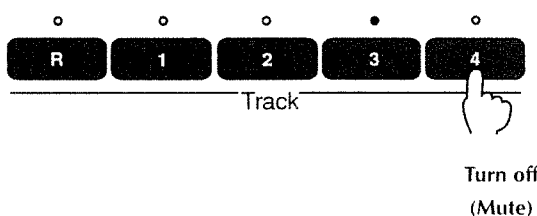

\* If you wish to hear the Metronome sound while playing, press the [Metronome] button at this point (the light will be turned on).

\* If the Tempo is too fast or too slow, press the [Tempo] button and adjust it with the [Value -] and [Value +] buttons.

- (3) Press the [Count In] button (the indicator should light).

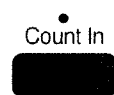

- (4) Press the [Rec] button. This puts the MT-120 in the Recording Standby mode.

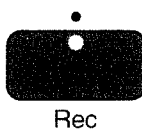

\* When playing ism music data or a Standard MIDI file, the message "Please Wait..." may appear on the screen.

If the light above a track button flashes in red, it indicates that there is no data recorded on that track. If there is data on a track, the light will flash in red and green.

- (5) Indicate which Track you wish to record on by pressing the appropriate Track button. In this example, we'll be recording on Track 2.

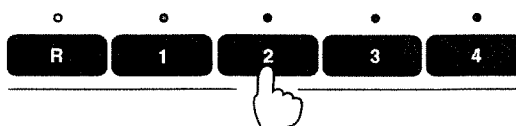



- (6) Press the [Play] button or depress the start/stop pedal.

After an audible two-bar count, recording starts (Count-In Recording).



Recording with Count-In on

When started at the beginning of the song

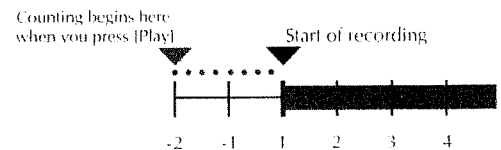

Now play the right hand part of "Minuet" along with the left hand part performed by the MT-120.



- (7) When the piece is finished, press the [Stop] button.

When the recording is finished, a mark (\*) appears in front of the song title to show that it is different from the song on the disk.

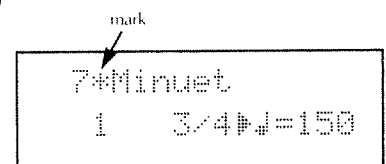

To listen to what you have just recorded, press [Reset] to go back to the beginning of the song, and then press [Play].

When you record at a different tempo, you can restore the tempo to its original speed by pressing the [Reset] button while holding down the [Tempo] button.

## Redoing a Recording

If you are not satisfied with what you have recorded, go back to a place a little earlier than where the mistake occurred, and record again from there.

When re-recording, it is probably better to record with the Count in function off (the [Count In] indicator is dark). Start play two bars before, then begin recording. If recording is to start in the middle of a bar, the music starts at the beginning of the previous bar.

Recording with Count-In off

When started at the beginning of the fifth bar

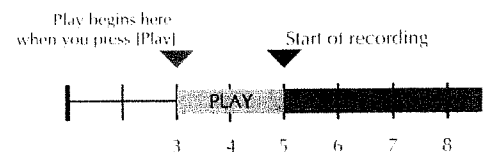

When started in the middle of the fifth bar

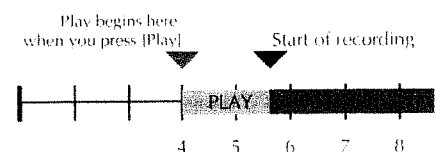

## Recording the Left Hand

Of course, this feature works both ways, so now let's try recording the left hand part of the Demo Song, and let the MT-120 play the right hand.

The steps are the same as before, except that in Step (2) press the Track 3 button to Mute the left hand part of the Demo Song. (Note that at this point Track 2 contains the right hand part you recorded earlier.)

Also, press the Track 2 button to Mute it (you don't want to hear what you recorded before). Then press the Track 4 button (the light will be turned on) so that you'll be able to hear the right hand part of the Demo Song as played by the MT-120. You can then record the left hand part along with it.

This time, in step (5), select Track 1 as the Track to record on. Follow the same procedure as before and record the left hand part.

To play along with the right hand part you just recorded:

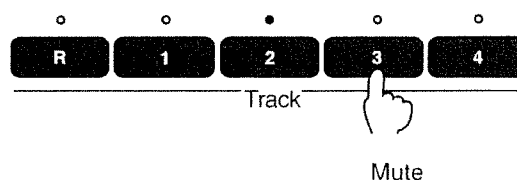

To play along with the right hand part from the Demo Song:

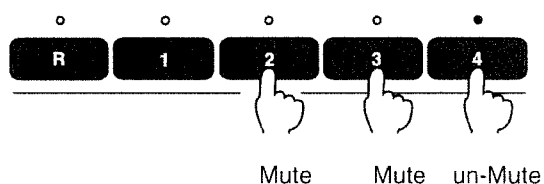

## Listening to the Song You have just Recorded

The left hand part you played is recorded on Track 1, and the right hand part is recorded on Track 2, as this picture indicates.

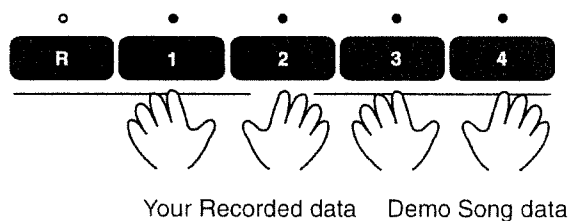

### To listen to the pre-recorded Demo Song

Press Track buttons 1 and 2 so that the lights are turned off. Ensure the lights for Tracks 3 and 4 are lit.

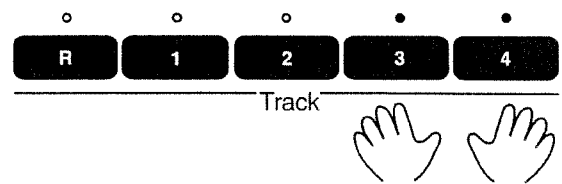

### If you wish to listen to the piece exactly as it was recorded

Turn off Tracks 3 and 4 and turn on Tracks 1 and 2.

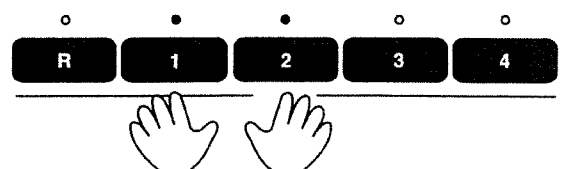

## Saving the Recorded Song onto a Disk

You will probably want to save your performance so that you can listen to it again at some time in the future. There is a disk Save function to enable you to do just that (see page 29).

\* If you select and play your saved song later, all the Tracks will be un-muted. You'll then have to turn off the Tracks you want to mute.

## 6. Playing Piano with the MT-120 as Accompaniment

Let's try playing along with the MT-120's multi-timbral sound source.

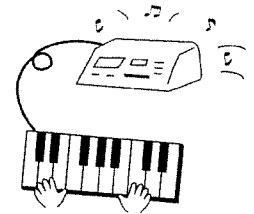

### Select a Song with MT-120 Accompaniment

(1) Press the [Song] button.



The cursor moves to here

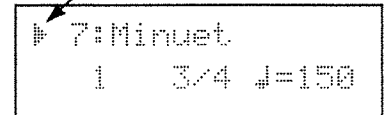

(2) Select the first song "Minuet+Orch" by pressing the [Value -] and [Value +] buttons. On this song, the "Minuet" is played on the digital piano with orchestral accompaniment provided by the MT-120.

- Value +

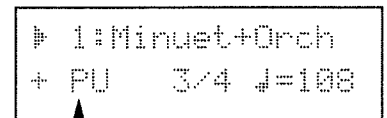

PU means that a few notes exist before the first bar. These are called "Pick Up" notes.

Let's listen to "Minuet+Orch."



Play

### Adjust the Volume of the MT-120

Adjust the volume using the MT-120's volume slider.

Volume



\* When the Piano switch on the back of the MT-120 is at Int, the piano's volume also changes.

\* If the digital piano is not in tune with the MT-120, adjust the master tune control on either one of the devices (see page 34).

### Music Minus One: Playing the piano part yourself

"Minuet+Orch" contains the data as shown at right. Press the buttons for Tracks 3 and 4 (the lights will go off), then try playing the "Minuet" with orchestral accompaniment.

To record what you play, mute Tracks 3 and 4, and record on Track 1.

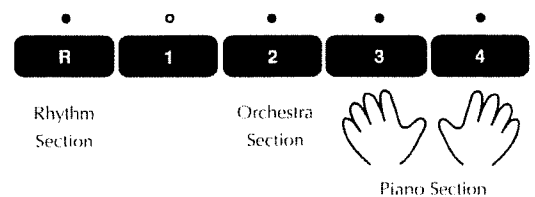

# 7. Recording a New Song

Now let's start from scratch and record an entire song. You could record the song you have just been practicing, or try recording any song you wish.

## Calling up a Blank Song

(1) Press [Song].

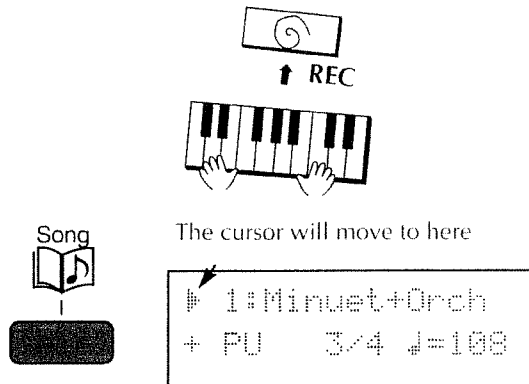

(2) Press the [Value -] and [Value +] buttons to select "NEW Song."

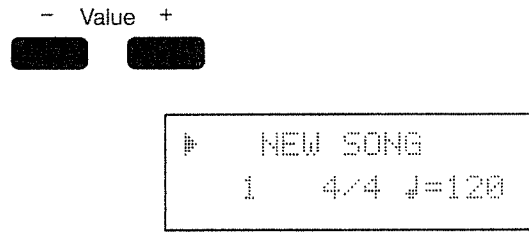

Data will be erased. Ok?

Enter

If you have recorded new material or have modified the song you are currently working on, you will see a message like the one shown above. It's basically telling you that any changes you have made will be lost by calling up another song, and asking you to make sure that this is indeed what you want to do.

If you decide you want to save your current song first, press the [Stop] button and then save the song. (See page 31 for how to save data onto a Disk.)

Otherwise, if you haven't made any changes or recorded anything worth saving, just press [Enter] to continue.

## Recording Along with the Metronome

(1) Press the [Count In] button (the indicator should light).



(2) Press the [Rec] button. The light on the Track button will blink.

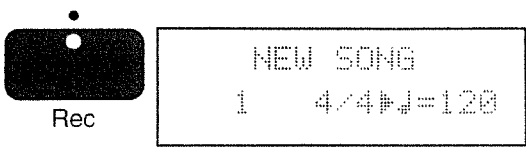

- (3) Press the Track button for the track you wish to record on. In this example, let's choose Track 3.

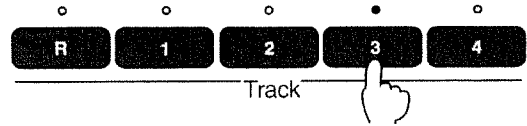

- (4) Press the [Metronome] button.  
The light above the button will be turned on and the metronome can be heard.



You'll have to set a Time Signature and Tempo.

- (5) Press [Beat] and select the time signature you wish with the [Value -] and [Value +] buttons.  
The metronome will change to match the selected time signature.

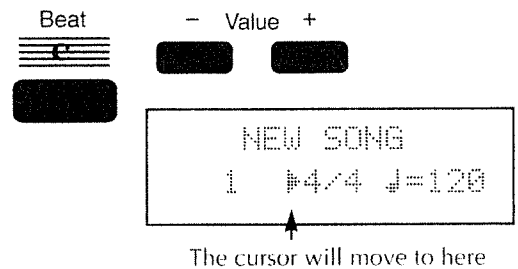

- (6) Press [Tempo], and adjust the Tempo with the [Value -] and [Value +] buttons.  
The metronome will change to match the selected tempo.

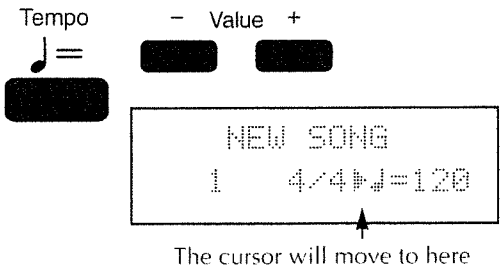

\* To change the beat of the metronome, hold down [Stop] and press [Sound]. This displays the Metro Beat setting screen, and you can then use the [Value -] and [Value +] buttons to change the beat (P. 47).

- (7) Press [Play].  
Recording begins after a two-measure audible count (Count-In Recording).



Now start playing!



- (8) When you've finished, press [Stop].



If you're not satisfied with what you've recorded, use [Bwd] and [Fwd] to move to the measure you want to change, and record it again.

---

## Recording without the Metronome Sound

The [Metronome] and [Count In] indicators should be off.

**(1) Press the [Rec] button.**

The light on the Track button will blink.

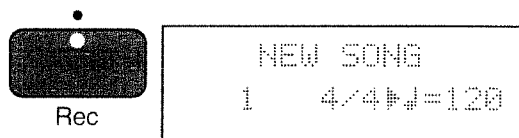

**(2) Press the Track button for the track you wish to record on. In this example, let's choose Track 3.**

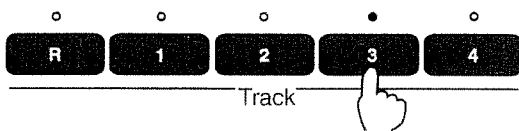

**(3) Play the keyboard without pressing the [Play] button.**

Recording starts automatically when you play the digital piano or depress a pedal (**Key-ON Recording**).



**(4) When you've finished, press [Stop].**



When the recording is finished, a mark (\*) appears in front of the song title to show that it is different from the new song.

If you wish to hear what you just recorded, Press [Reset] and then [Play].

This mark appears after the recording

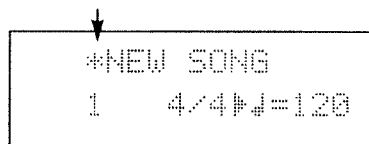

## Recording each Hand Separately

Following the instructions for recording each hand, record the left hand on Track 3. Then press [Reset] and repeat these same steps, this time recording the right hand part on Track 4 while listening to the left hand recording on Track 3. You can use the pedal while recording the part for either hand.

## Saving the Recorded Song onto a Disk

There is a way to "save" your performance onto a disk so that you can listen to it later. See next page for more information.

---

## 8. Saving Data onto a Disk

Here's how to save a recorded performance onto a disk so you can play it back again later.



If you have just finished recording a new song, you can go back and play it over as many times as you like. However, if you load a different song, or turn off the power to the MT-120, the song you had in memory will be erased. The only way to save data for long periods of time is to copy it onto a disk.

\* Before handling these disks, check out the section called "Using Disks" on page 9.

\* New data cannot be written onto the Demo Song disk.

\* Disks should be purchased at the store where you bought your MT-120.

### Formatting a Disk

A brand-new disk (or one that was used with some other machine) must first be "formatted" before you can use it with the MT-120. Don't skip this step, because if the disks are not formatted for the MT-120, you will be unable to read them or write anything onto them.

\* If you wish to purchase more disks, buy only disks marked "2HD" (high-density) or 2DD (double-density). Whenever possible, use 2HD disks. This is because the data access speed of a 2DD disk is somewhat slower than that of a 2HD, and this may on rare occasions cause playback errors.

\* This formatting process erases all the data on the disk. Make sure you have the correct disk in the drive before performing the format operation!

**(1) Press the EJECT button on the disk drive to eject the Demo disk.**

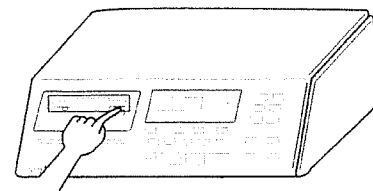

**(2) Press the [Disk/Tune] button.**

Disk/Tune



(3) Use the [Value -] and [Value +] buttons to select "Disk Format," and press [Enter].

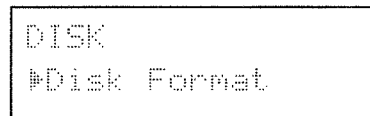
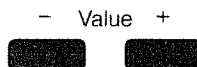

You'll see a screen like this:

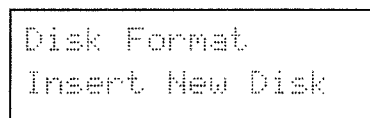

(4) Insert the new disk into the disk drive.

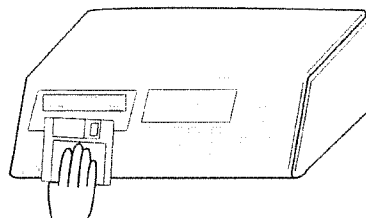

Now the screen will look like the one to the right. As mentioned, formatting will erase any old data on the disk. This step gives you one more chance to check your data and prevent accidental erasures. This is a new disk, so it's OK.

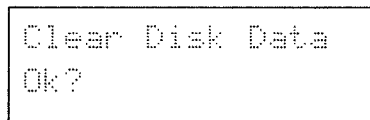

(5) Press [Enter] to start formatting.

\* If you wish to return to the previous condition, press [STOP].

While formatting, you'll see this screen:  
When formatting is complete, the display will return to the Play screen.

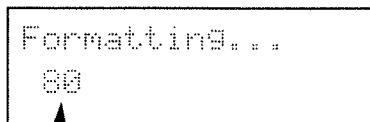

Count down

OK, now that the disk is ready, you can save the song you recorded onto it.



## Saving to a Disk

In this step you will save the recorded song data onto the formatted disk.

- (1) **Make sure that the disk you wish to save data on is in the disk drive.**

Press the [Disk/Tune] button.

Disk/Tune



- (2) **Use the [Value -] and [Value +] buttons to select "Save As," and press [Enter].**

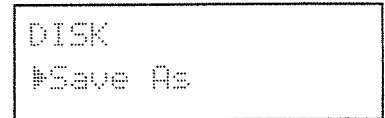

- (3) **A number between 1 and 99 that identifies where the song data is stored on the disk. Use the [Value -] and [Value +] buttons to select this number.**

For this example, we'll store the song at Save Location 1.

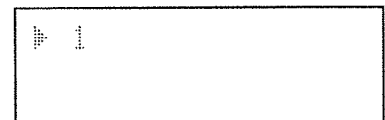
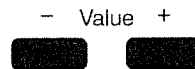

- (4) **Press the [>] button, then give the Song a Name.**

Press the [Value -] and [Value +] buttons; you'll see letters and numbers flash by the point above the "cursor" (the underline). Use these characters to enter the name for your song. Move the underline (cursor) itself from space to space with the [<] and [>] buttons.

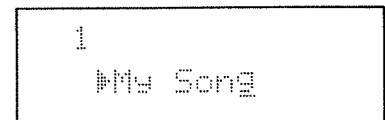
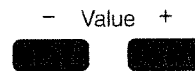
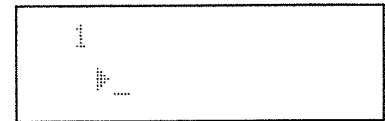

- (5) **Press [Enter].**



You'll see a screen like the one to the right. It's just asking you if you're sure this is the name you want for your song. This is the last chance to change the song name.

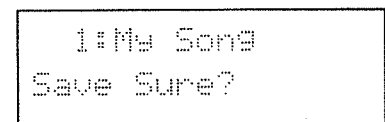

- (6) **Press [Enter] to start the Save operation.**



\* If you wish to return to the previous condition, press [STOP].

When the Save operation is finished, the display will return to the Play screen.

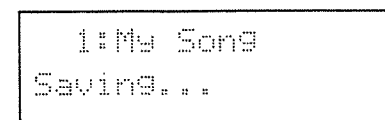

---

## 9. Turning the Power OFF

Before turning off the power, make sure that you have saved any important songs onto a disk. See page 29 for the procedure.

Otherwise, follow the steps below:

- (1) Press the EJECT button and remove the disk.

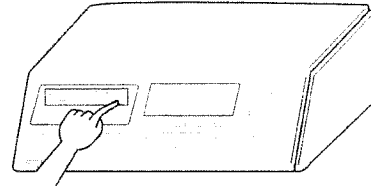

- (2) Turn off the MT-120.

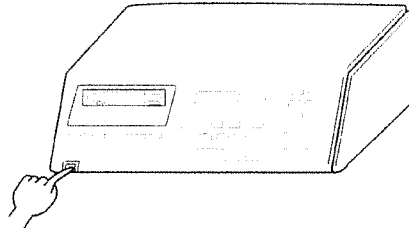

- (3) Turn off the piano.

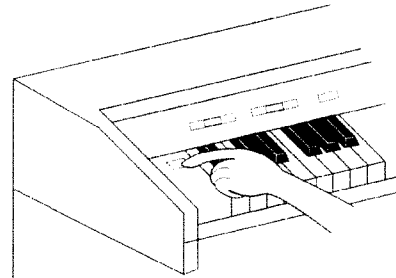

# 2

## Playing the Sounds of the MT-120

<b>1. Tuning the MT-120 to Your Digital Piano (Tune) .....</b>	<b>34</b>
MT-120 Tuning .....	34
Tuning Your Digital Piano .....	34
<b>2. Enjoying the Sounds of the MT-120 (Sound).....</b>	<b>35</b>
Selecting the MT-120's Sounds .....	35
About Part 10 (the Rhythm Part) .....	36
Changing the Volume of a Part .....	36
Turning Part Mute On and Off .....	36
When You Want to "Lock in" the Changes for Part Volume .....	37
Returning to the Piano Sound .....	37
<b>3. Recording an Ensemble Song.....</b>	<b>38</b>
Calling Up a Blank Song.....	38
How to Set Up for an Ensemble .....	38
Recording the Drums.....	39
Selecting the Rhythm Part .....	39
Loop Recording .....	40
Recording the Bass .....	42
Selecting the Bass Part.....	42
Recording the Bass Part.....	43
Recording the Chords and Melody .....	43

# 1. Tuning the MT-120 to Your Digital Piano

You may want to match the pitch of the MT-120's sounds to those of your digital piano; here's how to do that.

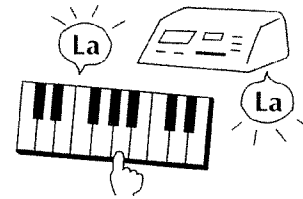

## MT-120 Tuning

You can change the tuning using the Master Tune feature on the MT-120 as follows.

\* The GS sound source is initially tuned so that A4=440.0Hz.

- (1) Press the [Disk/Tune] button two times.

Disk/Tune



The display will show the frequency of the tuning note "A4".

- (2) Use the [Value -] and [Value +] buttons to adjust the pitch (up or down).

- Value +

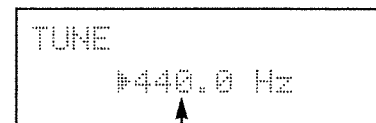

Master Tune

- (3) Pressing [Play] causes an A4 (la) pitch to sound.

This stops when you press [Stop].



Play

- (4) Press [Enter] when everything is tuned to your satisfaction. The Play screen display will return.



## Tuning Your Digital Piano

Check the Owner's Manual to see how to change the tuning of the digital piano you're using.

If it's a Roland Piano, there will be a control on the back panel that will allow you to adjust the tuning.

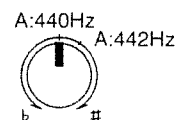

## 2. Enjoying the Sounds of the MT-120

The GS sound source on the MT-120 comes complete with a variety of sounds and tones for you to play. The best way to access these is to use your digital piano.

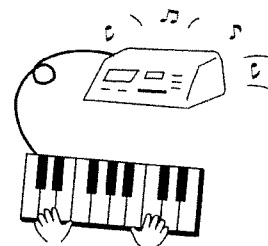

### Selecting the MT-120's Sounds

The sound source of the MT-120 has 16 Parts. Each Part can be played separately using the Tones you want (See page 61). Here's how to play a Part on the digital piano with the Tones of your choice.

#### (1) Press the [Sound] button.

\* The Part displayed in the screen is the MT-120 sound that will be played when you play a key on your digital Piano. In this case, this is Part 1. When the Piano switch on the back of the MT-120 is set to Ext, the sound source on the digital piano is Part 1.

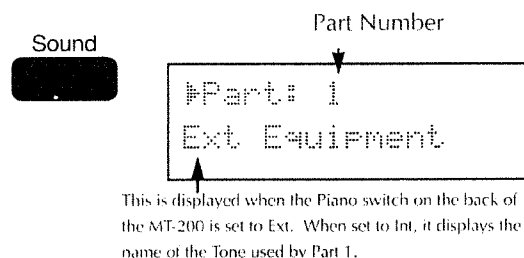

#### (2) By pressing the [Value -] and [Value +] buttons, you can set the part to any part except 1.

\* On the MT-120, Part 1 is reserved for the piano part.

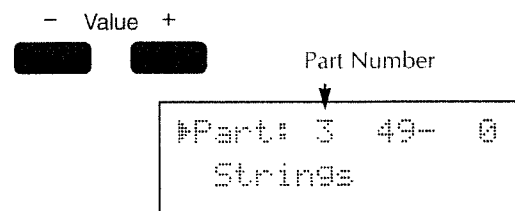

#### (3) Press the [>] button, and the "▶" cursor will move over to the Tone name. Use the [Value -] and [Value +] buttons to select the Tone for the Part.

Now when you play the keyboard, you'll hear the sound indicated in the display.

\* If the displayed Tone doesn't play, check whether the Rx CH Conv switch (P.80) is set to "On."

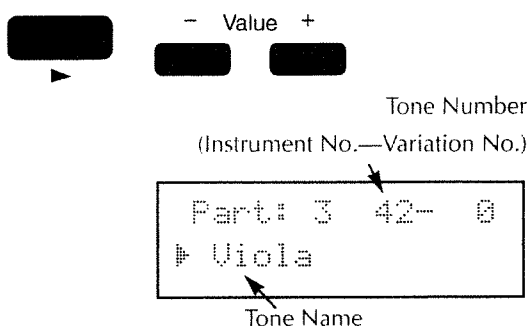

### About Part 10 (the Rhythm Part)

Part 10 is used exclusively by the Drum Set. This Part is unlike the others, because the Drum Set sound is different for each key of the digital piano. With the Violin sound, for example, every key pressed plays a violin tone. But with the Drum Set, each key is different: bass drum, snare drum, and so on.

When you make a Song on the MT-120, you can't use this part to play tones for melodic instruments. Here's how to change the Volume, and how to turn the Mute on and off for any Part.

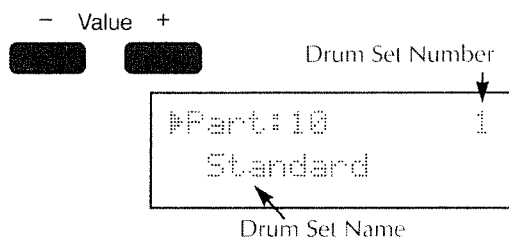

### Changing the Volume of a Part

- (4) Press the [>] button twice to move the "P" cursor to "Vol:" you can change that setting with the [Value -] and [Value +] buttons.

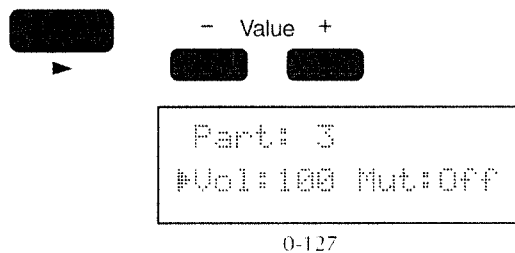

### Turning Part Mute On or Off

- (5) Press the [>] button to move the "P" cursor to "Mut:" you can turn Mute on or off with the [Value -] and [Value +] buttons.

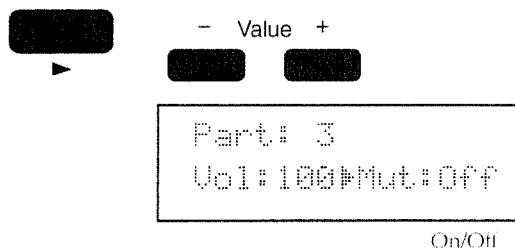

- (6) When you're done making the Part settings, press [Stop].



This returns the MT-120 to the Play screen.

### When You Want to "Lock in" the Changes for Part Settings

In step 6, when you press [Stop] to return to the Play screen, the volume levels and the Tone for each Part are changed temporarily.

If you use buttons like [Reset] or [Bwd] to return to the start of the song or perform Count-In recording, these changes are deleted and the original settings take effect again.

There is a way to "lock in" the volume settings and the Tone for the Parts. To do this, then when you reach step 6, press [Enter] twice instead of [Stop]. After you've done this, then the original settings will not take effect again even if you press [Reset] or perform Count-In recording. Also, if you save the song, the changed settings are saved right along with it.

\* The Mute settings cannot be saved with the song.

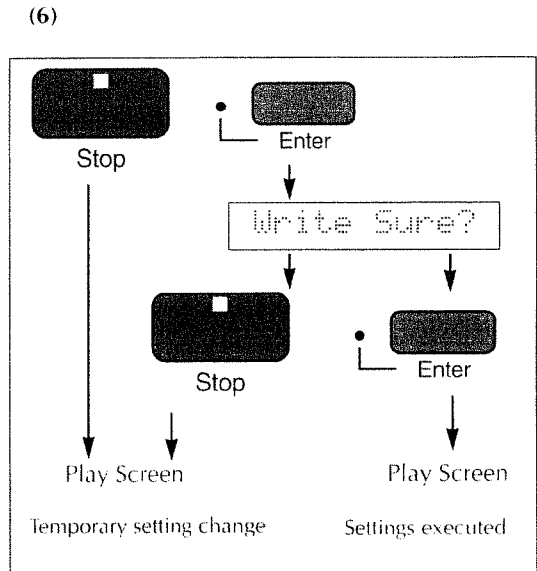

### Returning to the Piano Sound

(1) Press the [Sound] button and press the [Value -] and [Value +] buttons until "Part: 1" is indicated. Now you can play the digital piano sound again.

(2) Press the [Stop] button to return to the Play screen.

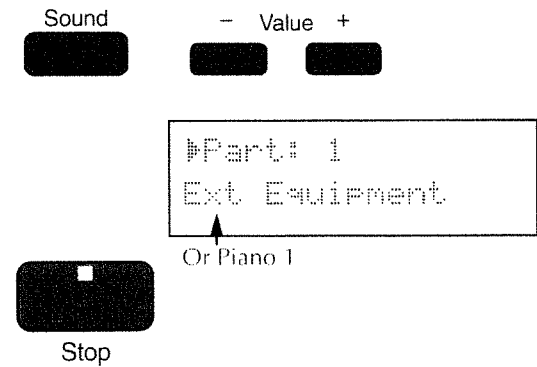

### 3. Recording an Ensemble Song

You can create and record music with a full ensemble of instruments using the GS sound source built into the MT-120. In this section, we'll explain how to record drums, bass, chords and melody (in that order).

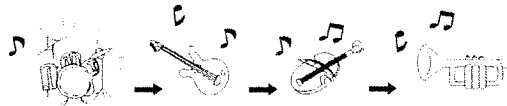

#### Calling Up a Blank Song

(1) Press the [Song] button.

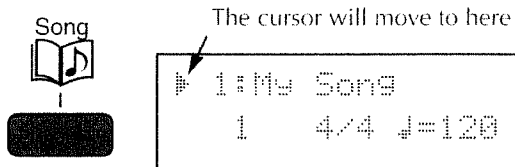

(2) Press the [Value -] and [Value +] buttons to select "NEW Song" in the display.

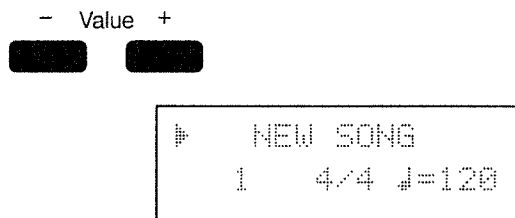

If there is an asterisk shown in front of the Song Name (indicating that the Song has been previously recorded or changed), the display will be like that shown at right. It's just checking to make sure it's OK that the old song will be overwritten by the new, blank song you're calling up. If you're sure that it's OK, go ahead and press [Enter]. However, you might wish to press [Stop] at this point and perform a save operation. (See page 56 for more information about the Save procedure.)

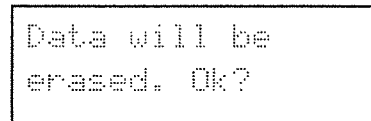

#### How to Set Up for an Ensemble

The sound source of the MT-120 has 16 Parts. When making an Ensemble song, first decide which Parts will be played with which tones, then play the digital piano connected to the MT-120 and record the Part.

With ordinary recording using an electronic piano, only one Part can be recorded per Track. The MT-120 has five Tracks (R, 1, 2, 3, and 4), which means you can record five-part ensembles.

\* The rhythm (drums) must be recorded on Part 10.



## Recording the Drums

### Selecting the Rhythm Part

**(1) Press the [Sound] button.**

\*The display will show the Part which is being played by the external keyboard. In this case, this is Part 1. When the Piano switch on the back of the MT-120 is set to Ext, the sound source on the digital piano is Part 1.

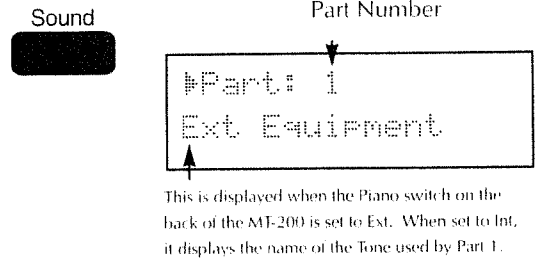

**(2) Press the [Value -] and [Value +] buttons to select "Part: 10."**

You'll hear drum sounds when you play the external piano.

\* On the MT-120, Part 10 is reserved for the Rhythm(Drums).

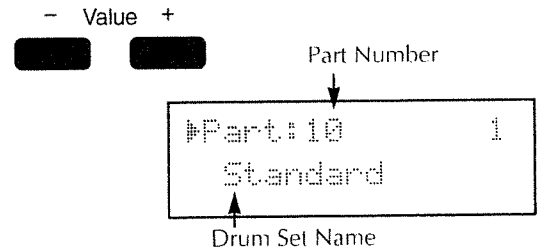

**(3) There are 9 different drum sets (include SFX Set) on the MT-120. When you wish to switch among them, press the [>] button to move the cursor over to the Drum Set Name, and select the desired set with the [Value -] and [Value +] buttons.**

Now when you play the piano, you'll hear the drum set you've selected.

\* If you select the SFX set, there will be no audible count.

If you wish to adjust the Volume setting, press [>] again to proceed to the Settings screen. (See page 36 for more on this.)

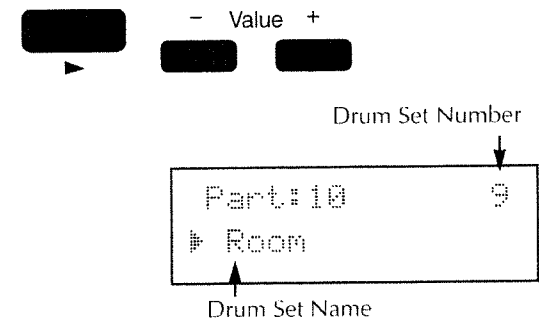

**(4) Press the [Enter] button.**

\* When you wish to switch among drum sets or change the Volume of the part, you'll see a screen (like the one at the right) asking you if you're sure of the changes you're making. Press the [Enter] button (refer to page 37).

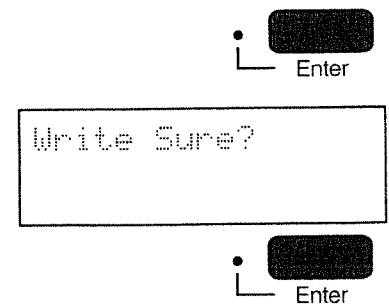

## Loop Recording

In Loop Recording, you can layer drum sounds one on top of another, continuing to record and adding data as the pattern plays over and over. This is similar to the way a lot of drum machines operate.

You can set the length of this Loop with the A and B Markers.

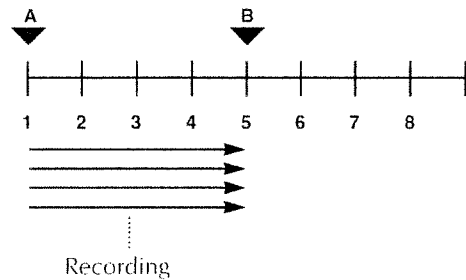

- (1) You can't put a marker at a spot that has never been recorded on, so first you may have to create a "blank track," i.e., turn on recording but don't play anything on the selected track for the whole song.

\* Once you record with a Time Signature, you won't be able to change it afterwards, so you should set the beat before the recording of the blank track.

- (2) Use the [Bwd] and [Fwd] buttons to move to the point where recording is to start, then press the Marker A button.

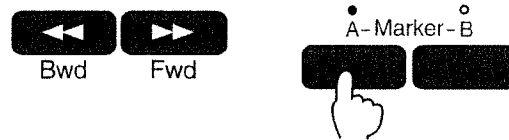

- (3) Use the [Fwd] button to move to the point where recording is to end, and press the Marker B button.

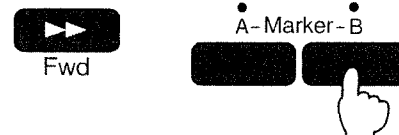

To record four bars from the start of the first bar, set Marker A at the beginning of the first bar, and Marker B at the beginning of the fifth bar.

- (4) Press [Repeat], and the indicator above the button will light.



- (5) Press the [Count In] button to turn on the button's light.

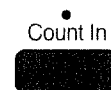

- (6) Press [Rec].

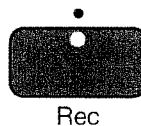

- (7) Select the track you wish to record on by pressing the appropriate track button. At this point it would be the Rhythm Track (R).

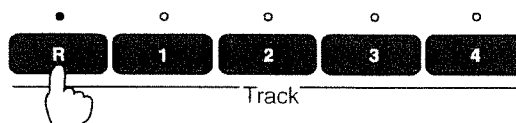

(8) If you wish to record along with the Metronome, press the [Metronome] button; the indicator will light.

Press the [Tempo] button, and adjust the Tempo with the [Value -] and [Value +] buttons.

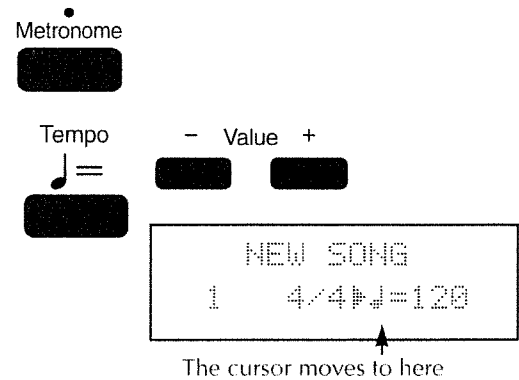

(9) Press [Play].

There is an audible two-bar count-in before recording starts.

Recording starts from the Marker A point.

When the recording reaches Marker B, the MT-120 returns again to the A position and repeats. You hear everything you have just recorded as the pattern cycles, so you can slowly build up a Part by listening and recording along with it.

The best way to record using this method is to start with the bass drum, then play the snare drum, toms and hi-hat and so on.

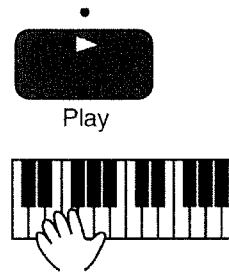

(10) When you've finished, press [Stop].

\* If you're not satisfied with what you've recorded, then cancel the Repeat, record the first rhythm sound, and repeat the procedure from step 4 to re-record the remaining rhythm sounds.

When you have finished recording in one section, all you have to do is move the Markers to a new section and you can start Loop Recording there in the same way.

(11) After the Drum Part has been recorded, press the [Repeat] button to turn off the light.

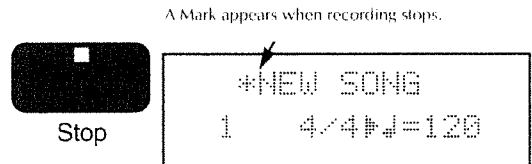

## Recording the Bass

### Selecting the Bass Part

(1) Press the [Sound] button. You'll see the screen again which shows what Part will be played by your external keyboard.

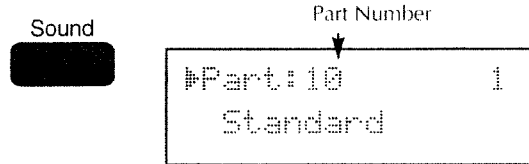

(2) Select "Part: 2" by pressing the [Value -] and [Value +] buttons. Now when you play the external keyboard, you'll hear a bass sound from the MT-120.

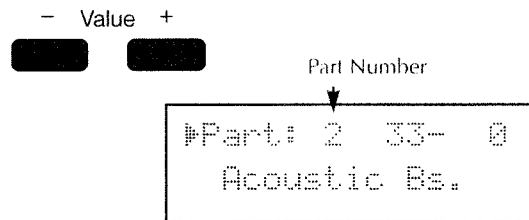

(3) If you wish to change the bass sound, just move the cursor over to the Tone Name entry with a press of the [>] button and spin through a few options with the [Value -] and [Value +] buttons. When a new bass sound is indicated, try it out by playing a few notes on the keyboard.

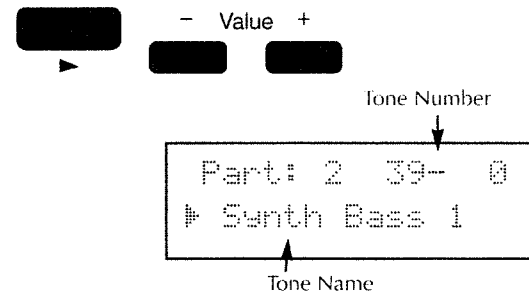

Press the [>] cursor key once again if you wish to move on to the screen for setting Volume (refer to page 36).

(4) Press the [Enter] button.



\* This signals your intention to save the changes you made to the bass sound. Whenever you change the Volume of the Part, you'll see a screen (like the one at right) asking you if you're sure of the changes you're making. Press the [Enter] button (refer to page 37).

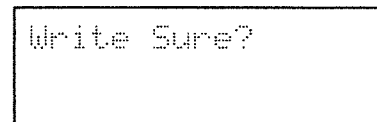

## Recording a Bass Part

- (1) Press [Reset] to start at the top of the song.
- (2) Press [Count In] so that the light comes on.
- (3) Press [Rec] to put the MT-120 in Recording Standby.
- (4) Indicate which track you wish to record on (Track 2 in this case).

Now, let's record.

- (5) Press [Play] to start recording.  
There is an audible two-bar count-in before recording starts.

In this recording you will hear the drums, so you have something to play along with as you record.

\* If there's any data already recorded on Track 2, it will be overwritten by the new data you record.

- (6) When recording is complete, press [Stop].

## Recording the Chords and Melody

Once you understand how to record the bass Part, you'll understand how to record the other Parts because the procedure is the same.

When recording is over, give the music a Song Name and save it onto disk (page 57).

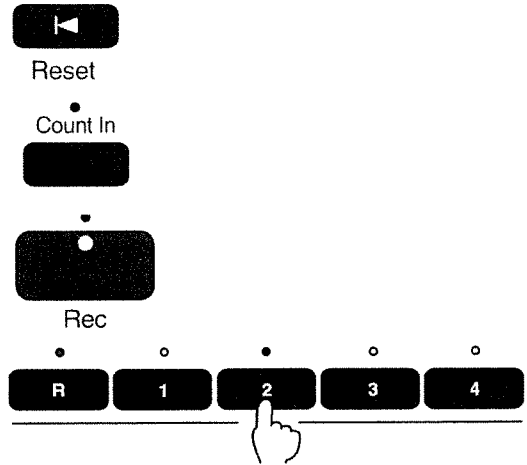

---

# MEMO

# 3

## Handy Features

<b>1. Playing Songs on the Disk One After Another</b>	
<b>(All Song Play)</b> .....	46
<b>2. Changing the Metronome Resolution (Metro Beat)</b> .....	47
<b>3. Marking Places in the Music (Marker A and B)</b> .....	48
Using the Marker Feature .....	48
How to Set a Marker .....	48
Setting Marker Resolution .....	49
Setting a Marker .....	49
Deleting a Marker .....	50
Jumping to a Marker .....	50
<b>4. Recording Pickup Notes</b> .....	51
<b>5. Playing in Sync with an External Device</b> .....	52
Getting Ready .....	52
Synchronized Play .....	52
Starting and Stopping Playing on Other Instruments .....	53
Ending Synchronized Play .....	53

# 1. Playing Songs on the Disk One After Another

The songs will play from first to last in the order they're arranged on the disk.

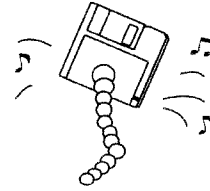

This function plays all the songs on the disk, one after another.

**(1) Insert the disk you want to play into the disk drive.**

**(2) Press [Song], then use the [Value -] and [Value +] buttons to choose the starting song for continuous play.**

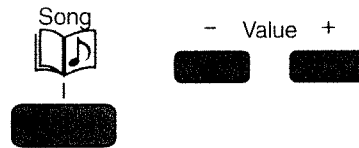

**(3) Press the [All Song Play] button.**

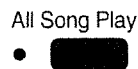

This makes the lights for the [All Song Play] and [Play] buttons go on, and playing starts.

\* If you press [All Song Play] while recording or after a change has been made (when the "\*" modify mark is displayed), the MT-120 will ask you if you want to delete the song. If you do want to erase it, press [Enter]. If you want to keep the song, press [Stop] and save the song on disk (P. 31, 56).

Data will be  
erased. OK?



When the last song finishes playing, the MT-120 returns to the first song, and keeps playing. Play continues in this way until the MT-120 is stopped.

**(4) To stop playing, press [Stop]. This makes the lights go out, and the MT-120 returns to the single-play mode.**



\* Pressing [Stop] halts the music immediately, even when in the middle of a song.

If you press [Reset] during play, play stops immediately and begins again at the start of the same song.



## 2. Changing the Metronome Resolution

You can change the resolution of the Metronome built into the MT-120. There are six different resolution settings from which to choose.

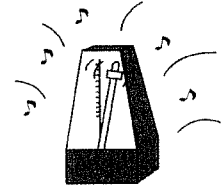

(1) Hold down [Stop] and press [Sound].

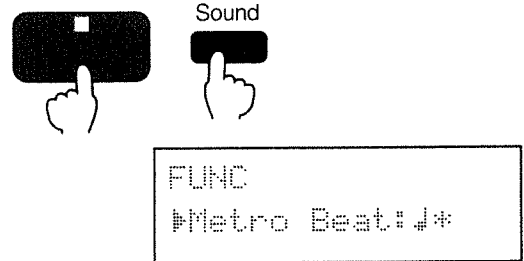

(2) Select the "Metro Beat" using the [Value -] and [Value +] buttons.

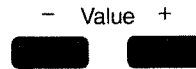

(3) Use the [>] button to move the "♯" cursor to the right, and then use the [Value -] and [Value +] buttons to select the note that corresponds to the new metronome beat.

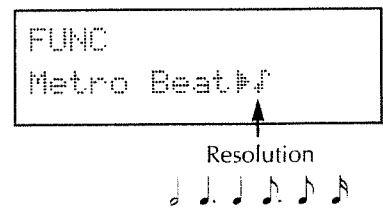
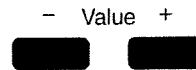

For example, if it's set to quarter notes and a 4/4 time signature, you'll hear 4 beats to the bar. If it is set to eighth notes with the [Value -] and [Value +] buttons, 8 beats to the bar will be heard.

\* A "\*" mark next to a note indicates the resolution that was set at the time the song was recorded.

(4) Press [Enter], and the Play screen will return.



## 3. Marking Places in the Music

We have already learned how to set up two Markers (A and B) in a song. It is also possible, however, to set them in the middle of a measure.



### Using the Marker Feature

#### Jumping to a Marker (page 50)

Wherever you are in a song, with just the press of a button, you can instantly move to wherever you set a Marker.

#### Setting the Repeat Play Length (page 21)

You can set and change the Repeat Play Length by moving the Markers. Marker A is the start of the Repeat Play Range, and Marker B is its end point.

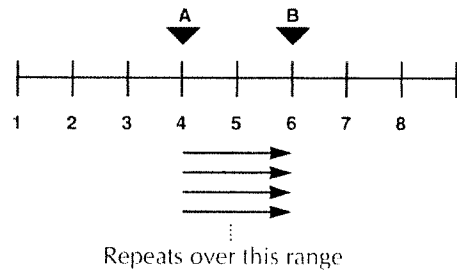

#### Loop Recording Repeat Length (page 40)

This operates the same as the Repeat Play Range, except that you can also record data into the pattern as it repeats.

### How to Set a Marker

- \* You must set Marker A before Marker B in the song.
- \* Markers A and B must be at least 2 quarter notes apart.
- \* When you play or record with the [Repeat] light on, you can't set or delete marks.
- \* If you wish to put a marker at a spot that has never been recorded on, first you may have to create a "blank track," i.e., turn on recording but don't play anything on the selected track for the whole song.

### Setting Marker Resolution

This specifies the location for setting a Marker when you press a Marker button.

(1) Hold down [Stop] and press [Sound].



(2) Use the [Value -] and [Value +] buttons to select "Mark Reso."

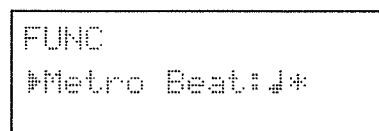

(3) Use the [>] button to move the "▶" cursor to the right, and then use the [Value -] and [Value +] buttons to select the type of resolution.

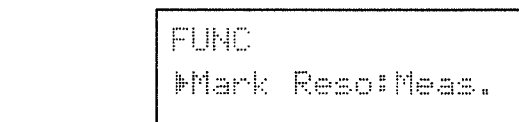

Meas. :This is for automatically setting a Marker above the bar line closest to the location where you press the Marker button.

♪ :This is for automatically setting a Marker at the beat closest to the location where you press the Marker button.

Free :This is for setting a Marker right at the place where you press the Marker button.

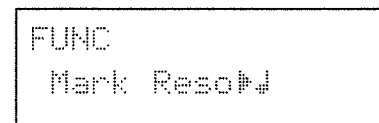

(4) Press [Enter].



The MT-120 returns to the Play screen.

### Setting a Marker

Here's what you need to do to set a Marker.

<When Play Is Stopped>

(1) Pressing [Marker A] or [Marker B] right after play is stopped sets a Marker at the location you've specified with the Marker Resolution setting.

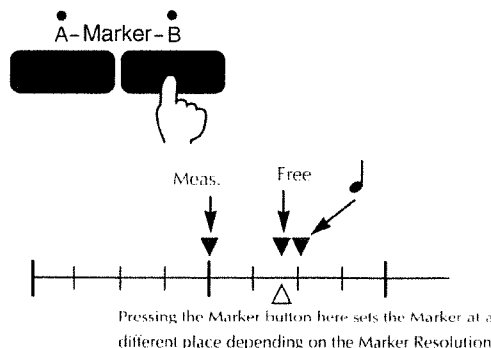

You can also use the [Bwd] and [Fwd] buttons to move to the measure where you want to set Marker A or B, then press Marker [A] or [B] to set the corresponding Marker over the bar line at the start of that measure.

\* In the example at right, you need to use the [Bwd] and [Fwd] buttons to display "4" and press [A], then use the [Fwd] button to display "6" and press [B].

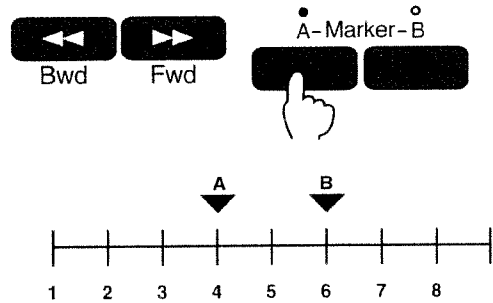

<During Play>

- (1) Press [Play] to start the music.
- (2) Listen to the song, and when you hear the place where you want to set Marker A or B, press the [Marker A] or [Marker B] button.

This sets a Marker according to the Marker Resolution you've selected.

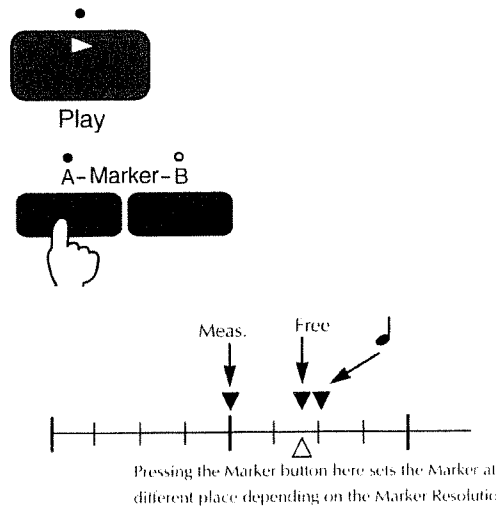

- (3) Press the [Stop] button to stop the playback.

Deleting a Marker

If you wish to reset a Marker, you have to delete it from its old position first, and then set it in the new position. Deleting (or "clearing") a Marker, anywhere in the song, is an easy operation.

- (1) While holding [Marker Clear], press the Marker button for the Marker you wish deleted (A or B).

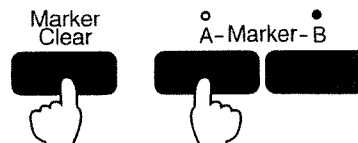

Jumping to a Marker

Wherever you are in the song, you can instantly move to the place you set a Marker.

- (1) Press the [Marker A] or [Marker B] button.

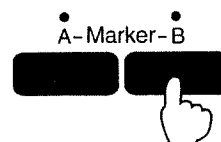

## 4. Recording Pickup Notes

You can record a song with a few notes before the first bar--"Pickup Notes."



(1) Press [Reset] to record from the beginning.



(2) Press [Count In] (make sure the light comes on).

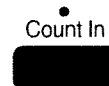

(3) Press [Rec].

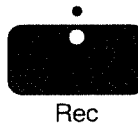

(4) Press [Bwd]. The display will now change to indicate 'PU' (which stands for "Pick-Up").

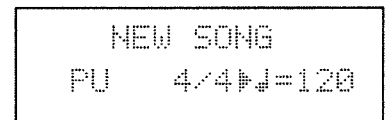

(5) Indicate which track to record on by pressing the appropriate track button.



(6) Press [Play] and you'll hear the usual two bars of count-in. This time, though, you'll be able to record notes during the one pickup measure just before the actual start of Bar 1, Beat 1.



You can start recording from here

\* If you're doing a Key-On Recording with the [Count In] light off, where you don't have to press the [Play] button first, recording will start from the top of the PU measure the instant you press a key.

(7) When finished recording, Press [Stop].



## 5. Playing in Sync with Other Instruments

You can play the MT-120 in sync with another sequencer connected to the MT-120. You can also use the [Play] and [Stop] buttons on the other sequencer to control the MT-120.

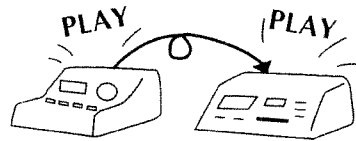

### Getting Ready

Use a MIDI cable to connect the MIDI IN connector on the MT-120 to the MIDI OUT connector on the other sequencer.

Make sure that the MIDI OUT switch (P.80) on the MT-120 is set to "1CH" and the Piano switch on the back of the unit is set to "Int."

### Synchronized Play

(1) Set the external sequencer to transmit a MIDI clock signal.

(2) Hold down the [Stop] button on the MT-120 and press [Disk/Tune].

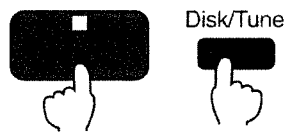

```
MIDI
#Sync      #Auto
```

(3) Select the "Sync" with the [Value -] and [Value +] buttons.

Move the "#" to the right with the [>] button, and use the [Value -] and [Value +] buttons to set the Sync switch to "Auto" or "Ext."

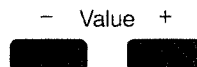

```
MIDI
Sync      #Ext
```

The MT-120 functions in line with the synchronization information sent from the external MIDI device (see P. 80).

(4) Use [<] to move the "#" to the left. Use the [Value -] and [Value +] buttons to choose "Rx CH Conv," and set it to Off.



```
MIDI
Rx CH Conv#Off
```

(5) Press [Enter].



This returns the MT-120 to the Play screen.

- (6) Select a song on the MT-120, then start playing the external sequencer.

The MT-120 starts to play at the same time.

- (7) When you're finished playing, stop the external sequencer.

### Starting and Stopping Playing on Other Instruments

- (1) Hold down the [Stop] button on the MT-120 and press [Disk/Tune].

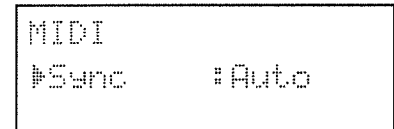
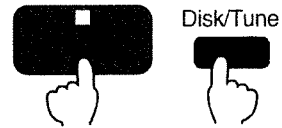

- (2) Select the "Sync" with the [Value -] and [Value +] buttons.

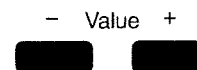

- (3) Move the "#" to the right with the [>] button, and use the [Value -] and [Value +] buttons to set the Sync switch to "Remote."

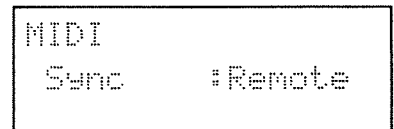

- (4) Press [Enter].



This returns the MT-120 to the Play screen.

- (5) Select a song on the MT-120, then press the [Play] button on the external sequencer. The MT-120 starts to play at the same time.

- (6) When you're finished playing, stop the external sequencer.

When the connected sequencer stops playing, the MT-120 also stops playing automatically.

### Ending Synchronized Play

When you've finished with synchronized play, again hold down the [Stop] button and press [Disk/Tune], and return the Sync switch to "Auto" and the Rx CH Convert switch to "On."

---

# MEMO



# 4

4

## Disk Handling

<b>1. Saving a Song onto Disk .....</b>	<b>56</b>
Saving a Song onto the Disk (Save) .....	56
Saving it as a New Song (Save As).....	57
<b>2. Copying a Song on the Disk (Song Copy) .....</b>	<b>59</b>
<b>3. Copying All the Songs on a Disk (All Song Copy) .....</b>	<b>60</b>
<b>4. Deleting Songs on a Disk (Song Delete) .....</b>	<b>62</b>

# 1. Saving a Song onto Disk

After making some changes to a song, you may still wish to retain the old version, too. You can do this by Saving the changed version using a different song number or song name: it's called the "Save As" procedure.

When there is a mark (\*) in front of the Song Name in the Play screen, it means that the song has been recorded or changed.

If you want to keep such recorded or changed song Data, you should save it to disk.

\* You don't even have to change the name of the song necessarily, as all songs on the disk also have a number (from 1 to 99) to identify them.

\* You have to Format disks before you can use them with the MT-120. There's more information on the Format operation on page 29.

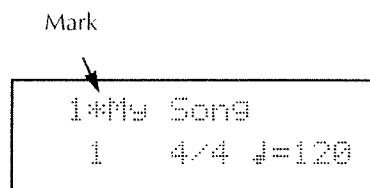

## Saving a Song onto the Disk (Save)

This saves the song with the same name and number as the original song on the original disk.

(1) Press the [Disk/Tune] button.

Disk/Tune



(2) Select the "Save" option with the [Value -] and [Value +] buttons and press [Enter].

- Value +



(3) Be sure to slide the disk's Write Protect tab to "Write", and then slide the disk carefully into the disk drive until you hear it click into place.



\* When you save a new song, or save to a different disk, the "Save As" function is used even when you select the "Save" function.

(4) Press [Enter] to go ahead with the procedure.

If you wish to stop anywhere during the procedure, just press [Stop].

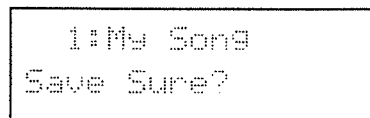

### Saving it as a New Song (Save As)

With the Save As operation, the song is saved under a different song number. You can also change the Name, if you wish.

(1) Press the [Disk/Tune] button.

Disk/Tune



(2) Select the "Save As" option with the [Value -] and [Value +] buttons and press [Enter].

- Value +

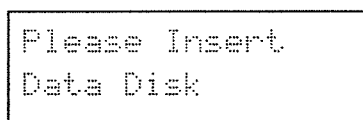

(3) As before, make sure the Write Protect tab is set to "Write", and slide the disk all the way into the disk drive until you hear a click.

Destination song number

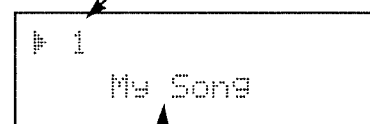

Name of the song to be saved

(4) You can select the song number with the [Value -] and [Value +] buttons.

- Value +



You can select a number between 1 and 99.

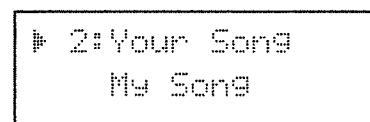

All the songs on the disk are organized by number.

If nothing is shown to the right of the song number, there no song assigned to that number.

The symbol ":" indicates that data has now been saved there.

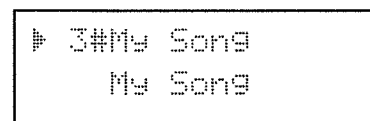

If you see this symbol "#" to the right of the song number, it means that the song you are trying to save is the original song on the original disk, and that it will be overwritten when it is saved.

- (5) Press [>] to move the "▄" symbol to the name of the song to be saved on the bottom line.

A Song Name can be up to 12 characters long. The Song Name is entered using the [Value -] and [Value +] buttons to select the character above the cursor (the flashing underline). Use the [<][>] cursor buttons to move to the next character space.

You can select the following characters by pressing the [Value -] and [Value +] buttons.

Space A ... Z a ... z 0 ... 9 ! " # \$ % & ' ( ) \* + , - . / : ; < = > ? @ [ \ ] ^ \_ ` { | }  
 ← Press [VALUE -] Press [VALUE +] →

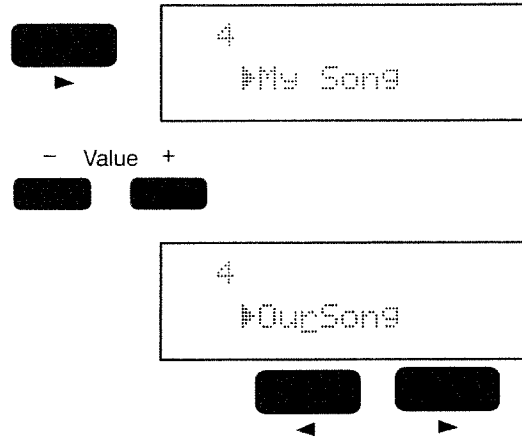

- (6) After you've finished naming a song, press [Enter].

You'll see a screen like the one at right, checking if it's OK to go ahead and save the song onto the disk.

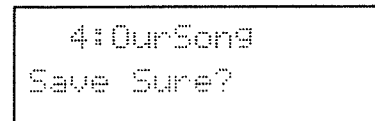

- (7) If all is OK, press [Enter] (press [Stop] to cancel). Pressing [Enter] starts the save operation. When completed, the Play screen will return.

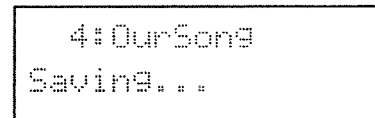

\* If the data saved with the MT-120 is of large size, not all data may be read in if you try to play back only a single song on another instrument supporting ism music data.

## 2. Copying a Song on the Disk

You can Copy your songs, one at a time, to a different disk or the same one.

\* You have to Format disks before you can use them with the MT-120. There's more information on the Format operation on page 29.

(1) Press the [Disk/Tune] button.

Disk/Tune



(2) Select the "Song Copy" option with the [Value -] and [Value +] buttons and press [Enter].

- Value +



\* If you have recorded new material, or have modified the song you are currently working on, you will see the message "Data will be erased. OK?". It's basically telling you that any changes you have made will be lost by performing this operation, and asking you to make sure that this is indeed what you want to do. If you decide you want to save your current song first, press the [Stop] button and then save the song. Otherwise, if you haven't made any changes or recorded anything worth saving, just press [Enter] to continue.

```
DISK
▶ Song Copy
```



(3) Insert the disk containing the song you want to Copy into the disk drive until it clicks into place.

```
Insert Src.Disk
```

(4) Select the song you wish with the [Value -] and [Value +] buttons and press [Enter].

```
Select Src.Song
▶ 1:My Song
```



You'll see the following screen until the MT-120 has finished loading the song into its memory.

```
Please Wait...
```

(5) Select the song number to which you wish to Copy the song using the [Value -] and [Value +] buttons.

```
Select Dest.Song
▶ 3
```

If you want to copy to a different disk, or see the message "Insert Dest. Disk" (the disk in the disk drive is a master disk, so you can't copy data to it), eject the disk and insert the new one (make sure the Write Protect tab is set to off). Select the song number as before.

(6) Press [Enter] to start the Copy (or [Stop] to cancel and start over). The Play screen will be returned after saving.



### 3. Copying All the Songs on a Disk

Here's another helpful operation for "backing up" your valuable data: it's similar to the Song Copy operation described previously, except that it selects all the songs on one disk to be copied to another disk.

- \* You have to Format disks before you can use them with the MT-120. There's more information on the Format operation on page 29.
- \* If the copy destination disk already contains songs, they will all be erased.
- \* If the copy source disk is a 2HD and the destination disk is a 2DD, not all data may fit on the destination disk. If this is the case, not even one song will be copied.

(1) Press the [Disk/Tune] button.

Disk/Tune



(2) Select the "All Song Copy" option in the DISK screen display using the [Value -] and [Value +] buttons and press [Enter].

- Value +



- \* If you have recorded new material, or have modified the song you are currently working on, you will see the message "Data will be erased. OK?". It's basically telling you that any changes you have made will be lost by performing this operation, and asking you to make sure that this is indeed what you want to do. If you decide you want to save your current song first, press the [Stop] button and then save the song. Otherwise, if you haven't made any changes or recorded anything worth saving, just press [Enter] to continue.

```
DISK
▶All Song Copy
```



(3) Insert the disk you wish to Copy into the disk drive until it clicks into place.

```
Insert Src.Disk
```

You'll see this screen until the MT-120 has finished loading the data into its memory.

```
Please Wait...
```

- (4) When the following display is shown, eject the first disk, and insert the new one (the "destination" disk). Make sure the Write Protect tab is set to "Write".

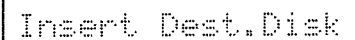

Insert Dest.Disk

As soon as it clicks into place, the data in the MT-120 will be written onto the destination disk.

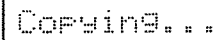

Copying...

- (5) When that's done, you'll see the following screen, telling you to eject the destination disk and insert the first one again; time to get some more data.

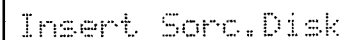

Insert Src.Disk

Repeat steps (4) and (5) as many times as needed. When All Song Copy has been completed, the Play screen returns.

## 4. Deleting Songs on a Disk

Here's how to erase songs you don't wish to keep any more.

- (1) Check to see that the Write Protect tab is set to "Write" on the disk containing the data you wish to be deleted, and insert it into the disk drive until you hear it click into place.

- (2) Press the [Disk/Tune] button.

Disk/Tune



- (3) Select the "Song Delete" option with the [Value -] and [Value +] buttons. Press [Enter].

- Value +



```
DISK
▶ Song Delete
```



- (4) Select the song you wish to delete with the [Value -] and [Value +] buttons and press [Enter].

- Value +



```
Select Del. Song
▶ 1:My Song
```



- (5) Are you sure this is the song you wish to delete? Press [Enter].

```
Delete Sure?
1:My Song
```



Not sure? To return to the previous condition, Press [Stop].

Either way, the Play screen will return.

```
Deleting...
1:My Song
```



# 5

## Making Use of Many 5 Kinds of Data

<b>1. ism music data (3.5-inch Disks)</b> .....	64
<b>2. Standard MIDI Files</b> .....	65
<b>3. Trying Minus One Play</b> .....	67
Using an Electronic Piano	
to play the MT-120's internal sound source .....	67
The Difference Between Minus One Play	
and Track Muting .....	68
Using a Guitar or Keyboard (with its own sound source)..	69
Adjusting the Volume for a Minus One Part.....	71

---

## 1. **ism music data (3.5-inch Disks)**

The MT-120 can play ism music data (sold separately). Also, just as with the Demo Song Disk, this data can be recorded and saved.

ism music data is a collection of songs made for the GS sound source. This music can be handled in the same way as the Demo Song Disk and Songs saved on the MT-120. Please consult your dealer for details.

**ism**

(Intelligent System of Music)

**The MT-120 can playback ism music data  
(on 3.5 inch floppy disks.)**

---

## 2. Standard MIDI Files

The MT-120 can also play Standard MIDI Files.

### Standard MIDI Files

The MT-120 is capable of reproducing data in the Standard MIDI File format. Standard MIDI Files contain data which is formatted in a standardized manner, thus allowing for song data to be played on equipment produced by a wide range of manufacturers.

If the data is a Standard MIDI File created for a GS sound source, it can be played back.

Even when you've selected a Standard MIDI File, you can record data, set A and B Markers, and save songs.

**When playing such data, be sure to set the Piano switch on the back of the MT-120 to Int.**

\* Depending on the size of the data, some song data cannot be played on the MT-120.

\* Depending on the data, the message "PU" may appear, or the measure number may change. If this happens, it means that the MT-120 is putting the data in the optimal format, and is not a problem.

### Roland SMF Music Song Data (sold separately)

A collection of songs (written in Standard MIDI File format) that can be played on all GM/GS compatible sound sources. Please consult your dealer for details.

### Song Data Written on a Roland MC-50MKII

If data was written for a GS sound source, you can play it back on the MT-120 after converting it to Standard MIDI File format.

### CAUTION

Depending on the data, there may be a long pause before play starts. When this occurs, "Please Wait..." is displayed on the screen.

---

## Some General Information About Standard MIDI Files

Standard MIDI Files written to play a GS Sound Source on an IBM PC or an IBM PC-compatible computer can be played and recorded on the MT-120 without having to make any changes.

Standard MIDI Files written on a variety of other sequencers and computers (Atari, Macintosh) can also be played if you save them onto a 3.5 inch (2DD) disk formatted for the MT-120 by your computer.

However, you should keep the following in mind:

- \* Don't save Standard MIDI Files on disks containing songs made on the MT-120. If you do save both types on the same disk, the Standard MIDI Files will not be displayed and cannot be played.
- \* For the Atari, you must format 3.5 inch (2DD) disks on the MT-120.
- \* You can only play files in the root directory which have a ".MID" file extension. The song number order will be the order in which the songs are stored in the directory.
- \* The Play screen will display the name of the song only for Standard MIDI Files in which the song Name is recorded as a sequence meta-event.
- \* Whenever possible, save converted files in Format 0. If you use Format 1, the following restrictions will apply:
  - Only data for up to 17 Tracks can be handled.
  - Some large-size data files will not play.
  - When you start play on a Format 1 file, it may display the message "Please Wait..." for a short time.
- \* You may or may not get it to playback perfectly every time, depending on the data itself.
- \* You should save Standard MIDI Files created on a Macintosh onto a disk formatted for the MT-120 using the Apple File Exchange program. You will need the Dayna File Disk Driver if you are using a Macintosh SE, II, or Plus.

## Some Important Points When Recording Standard MIDI Files

With the MT-120, the 16 Parts of Standard MIDI Files are automatically allocated to five Tracks as shown in the following table.

Track	R	1	2	3	4
Part (Channel)	10	1	Other	3	4

If you record a performance along with a Standard MIDI File, then when you select the recording Track, the Parts of the performance assigned to that Track are replaced with what you play. Be sure to select the recording Track after first checking the Tones assigned to the Parts in the Standard MIDI File.

## Some Important Points When Saving a Standard MIDI File with the MT-120

After changes or alterations have been made in the data, a Standard MIDI File cannot be saved on its original disk by the MT-120. Instead, save the data on a disk formatted with the MT-120.

When saved to disk using the MT-120, a Standard MIDI File is saved as MT-120 song data.

Once data has been saved with the MT-120, it cannot be played as a Standard MIDI File by other devices.

### 3. Trying Minus One Play

Here's how you can use Minus One Play to mute out a certain Part in the music data you have.

#### Using an Electronic Piano to play the MT-120's internal sound source

(1) Use a MIDI cable to connect the MIDI IN jack on the MT-120 to the MIDI OUT jack on the electronic piano.

\* Make sure that the Piano switch on the back of the unit is set to "Int," the RX CH Convert switch is set to "On," and the MIDI OUT switch is set to "1CH."

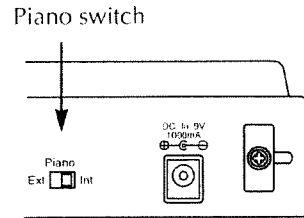

(2) Press [Song] and use the [Value -] and [Value +] buttons to select a song.

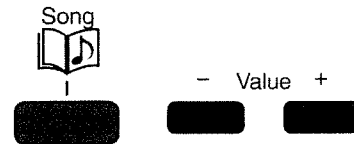

(3) Press [Minus One]. This makes the Minus One screen appear on the display.

The numbers above the screen indicate the Parts. The Part shown by the "1" is the part for Minus One play (the muted Part).

The Tone assigned to the Part displayed momentarily at the bottom of the screen.

\* If you don't press any buttons, then after a certain interval the bottom of the screen reverts to the Play screen, although the top area remains the same.

\* Muting is canceled for any Tracks that have been muted.

\* The Part for which the bar graph display disappears is the Part muted at Sound screen.

While this screen is displayed, you can change the tempo using the [Value -] and [Value +] buttons.

(4) Use [<] and [>] to move the cursor to the Part for Minus One play.

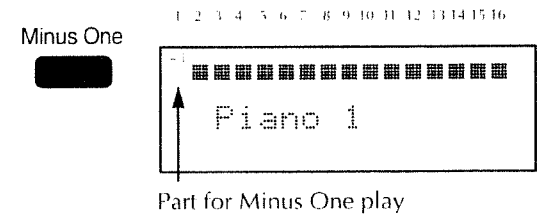

Part for Minus One play

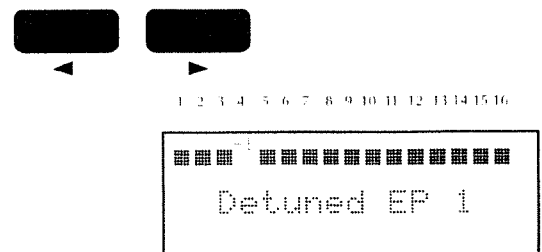
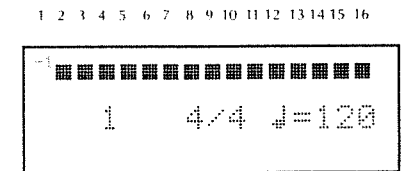

---

\* You can use Minus One play with only one Part at a time.

**(5) Press [Play] to start playing.**

When you play the electronic piano, you can play the music for the muted Part.

Pressing [Play] again causes only the muted Part to be played (Solo function). "S" appears on the display at this time. Press [Stop] to return to Minus One play.



\*Track Mute cannot be performed during Minus One Play.

**(6) When you've finished playing, press [Stop].**



**(7) Press [Minus One] again to cancel Minus One play and return to the Play screen.**

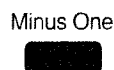

\* You can perform step (3) and (4) even during ordinary play.

## The Difference Between Minus One Play and Track Muting

The MT-120 assigns the 16 Parts in a Standard MIDI File to five Tracks (P. 66), so if you mute out Track 2, all the Parts in that Track are muted. When you want to mute out only a single Part with a Standard MIDI File, you use Minus One play.

## Using a Guitar or Keyboard (with its own sound source)

When you connect a guitar, keyboard, or other instrument to the MT-120, you can play the instrument and the MT-120 together, allowing you to enjoy ensemble performances.

### Making the Connection

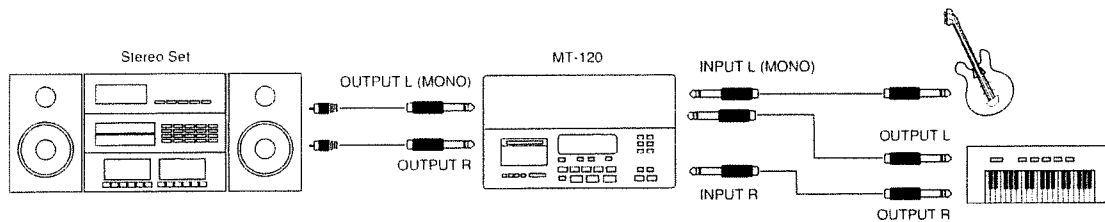

### Input Select Switch

On the back of the MT-120 is an input select switch for choosing either input from a guitar or line input. When you connect an instrument to Input, you need to make sure this switch is at the right setting for the kind of instrument you're using. Be sure to lower the volume on the connected amp when you change this switch setting.

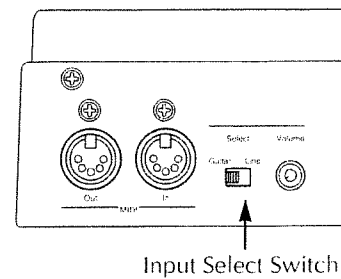

### Ensemble Play

- (1) Turn down the Input Volume control on the MT-120, and then make the right setting for the input selector switch on the back panel.

Guitar :Guitar  
Line :Keyboard

\* Make sure the Piano switch on the back of the unit is set to "Int."

- (2) Press [Song] and use the [Value -] and [Value +] buttons to pick the song to play.

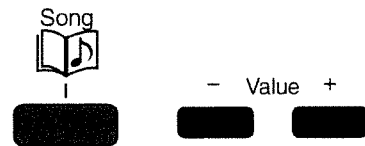

- (3) Press [Minus One]. This displays the Minus One screen.

Minus One  
[Minus One button]

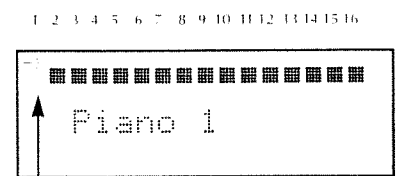

Part for Minus One play

The numbers above the screen indicate the Parts. The Part shown by the "1" is the part for Minus One play (the muted Part).

The Tone assigned to the Part displayed momentarily at the bottom of the screen.

\* If you don't press any buttons, then after a certain interval the bottom of the screen reverts to the Play screen, although the top area remains the same.

\* Muting is canceled for any Tracks that have been muted.

\* The Part for which the bar graph display disappears is the Part muted at Sound screen.

While this screen is displayed, you can change the tempo using the [Value -] and [Value +] buttons.

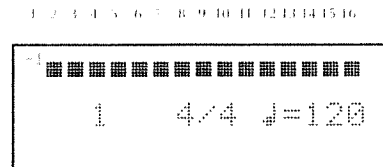

**(4) Use [<] and [>] to move the cursor to the Part for Minus One play.**

\* You can use Minus One play with only one Part at a time.

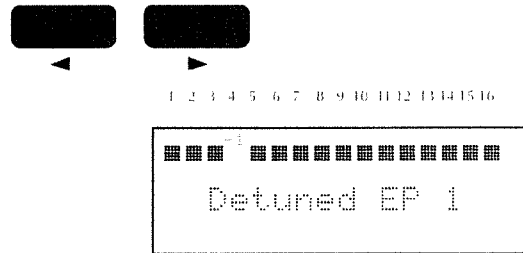

**(5) Press [Play] to start playing.**

You can now play the connected instrument in place of the muted Part, making it possible to play an ensemble.



If you want to adjust the volume of the connected instrument, use the Input Volume control on the back of the MT-120.

Pressing [Play] at this time causes only the muted Part to be played (Solo function). "S" appears on the display at this time. Press [Stop] to return to Minus One play.

\*Track Mute cannot be performed during Minus One Play.

**(6) When you've finished playing, press [Stop].**



**(7) Press [Minus One] again to cancel Minus One play and return to the Play screen.**

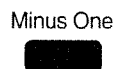

\* You can perform step (3) and (4) even during ordinary play.



## Adjusting the Volume for a Minus One Part

Minus One play lets you mute out a Part in song data and play that part yourself. You can adjust the volume level of the data for the muted Part on the MT-120.

For instance, if you want to make sure of the pitch of the Part you want to play (the muted part), it might be helpful to make it so that you can just hear the data for the muted part while playing along with that.

(1) Hold down [Stop] and press [Sound].

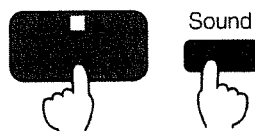

(2) Use the [Value -] and [Value +] buttons to select "-1 Part Vol."

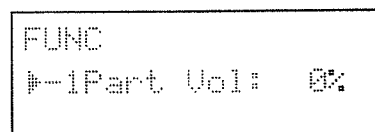
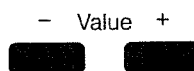

(3) Use [>] to move the "█" cursor, then use the [Value -] and [Value +] buttons to set the Minus One Part volume.

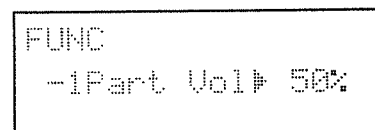

0% You can hear what you play and all sounds other than the muted Part (normal Minus One play).

50% You can hear what you play and all the other sounds plus the muted Part at 50% of its original volume level.

100% You can hear what you play, all the other sounds, plus the muted Part at its original level.

\* This setting is effective only with a Part for Minus One play. If you change the Minus One Part, the new Part takes the volume setting you made in step 3, and the old Part returns to its original volume level.

---

**(4) Press [Enter].**



The MT-120 returns to the Play screen.

\* If you mute some Parts at the Sound screen, you may not be able to hear the Parts other than the one selected for Minus One play. If this happens, go to the Sound screen and turn off Part Muting.

\* If you use a connected MIDI instrument to play the MT-120's internal sound source and try Minus One play, you should set the volume level to 0%. If the Minus One part volume is at any other setting than 0%, then the volume level of the Part you're playing will change at the same time as the volume level for the muted Part.

# 6

## MT-120 MIDI Information 6

1. About MIDI .....	74
2. The MT-120's Sequencer.....	75
3. The MT-120's GS Sound Source .....	76
4. MIDI Diagram of the MT-120 .....	78
5. MIDI Switching (MIDI).....	79

---

# 1. About MIDI

## What's MIDI?

The MT-120 can record and play back MIDI data, and can also receive and play this data.

Just what is MIDI?

MIDI stands for "Musical Instrument Digital Interface," and it serves as a uniform standard for exchanging information (such as performances) between electronic instruments and computers. By connecting instruments using a MIDI cable, data can be sent back and forth between the instruments.

MIDI is now an essential aspect of electronic musical instruments, and the MT-120 is no exception. Without MIDI, the MT-120 would not be able to record or play back digital piano performances, and the digital piano could not play sounds on the MT-120.

The MT-120 is designed so that it can be used easily with no special knowledge of MIDI. If, however, you want to get maximum benefit from your electronic instrument, you should read this chapter, which gives a simple explanation of MIDI and the MT-120.

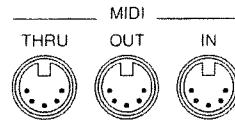

**MIDI connectors**

- OUT** :For sending data
- IN** :For receiving data
- THRU** :For sending out unchanged data received through the IN connector

## The Two MIDI Connectors of the MT-120

The MT-120 has two MIDI connectors: MIDI IN and MIDI OUT.

Normally, each of these connectors is used only to hook up an electronic piano (MIDI OUT Switches, P. 80). When you connect a MIDI keyboard other than an electronic piano, or a sequencer, or some other MIDI device, you may have to set the MIDI OUT switch to "1-16CH."

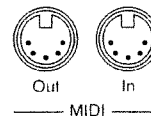

\* For details, see the MIDI diagram on page 78.

## 2. The MT-120's Sequencer

The following is a short explanation about the sequencer that's built into the MT-120.

### What's a Sequencer?

A sequencer is computer hardware and software which can play and record music--but not the way a tape recorder would record it. Instead of recording the sounds themselves, a sequencer records the actions: what the performer did on the instrument (usually a keyboard) that he or she was playing. This recorded data consists of information about when a note was played (in what "sequence"), which note, how hard it was played, and for how long was it held (sustained).

Then, during playback, the sequencer "plays" the keyboard the same way it was played when the data was originally recorded. You might think of it as a kind of electronic player piano.

However, a sequencer can do things no mechanical player piano or multi-track tape recorder could ever do. Opposite are some of the advantages of using a sequencer for recording music.

### The MT-120's Sequencer

This recorded data that we've been discussing is called MIDI data. Any electronic instrument that has a MIDI IN or OUT plug will be able to understand this data and play it.

The MT-120 sequencer uses its built-in GS sound source to play the MIDI data it records, and also sends out some of this data to play whatever electronic MIDI keyboard you have it connected to.

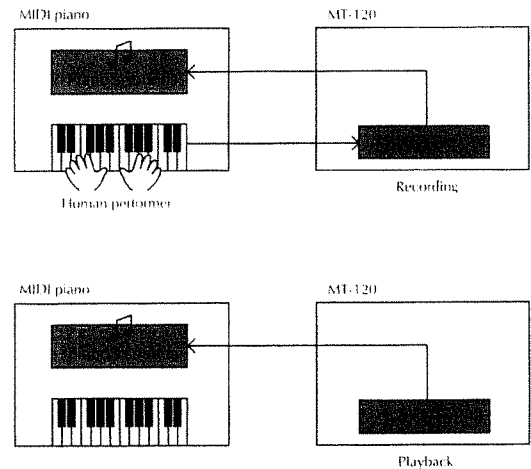

### Advantages of Sequencers

- \* You can change the Tempo of playback without changing the pitch.
- \* You can easily modify or add more data after recording is over.
- \* You can playback a recorded performance with whatever sounds you want; not just the one it was recorded with.
- \* Rewind and Fast-Forward are almost instantaneous.
- \* No "cross-talk" from one recorded Track to the next.
- \* Compared with sampling recording, the amount of data is reduced considerably.

### 3. The MT-120's GS Sound Source

Here we'll talk about the GS sound source that's built into the MT-120.

#### What's a "Sound Source?"

A "sound source" is where the sounds come from: an electronic device which acts as the "source" or generator of all the "sounds" you play on the MT-120. The MT-120's sound source is capable of playing up to 16 different Parts at one time, and there are over 200 instrument sounds to choose from. A Part can play the MIDI data coming from the MT-120's built-in sequencer, or from your performance on a connected MIDI keyboard.

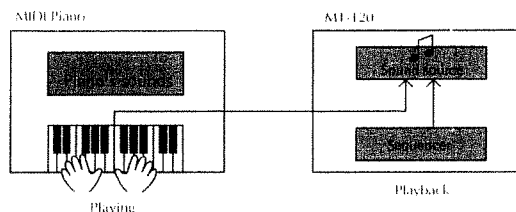

#### General MIDI System

The sound source in the MT-120 conforms to General MIDI System Level 1 specification.

The General MIDI System is a universal set of specifications for sound generating devices which has been agreed upon by both the Japanese MIDI Standards Committee and the American MMA (MIDI Manufacturer's Association). These specifications seek to allow for the creation of music data which is not limited to equipment by a particular manufacturer or to specific models.

The General MIDI System defines things such as the minimum number of voices that should be supported, the MIDI messages that should be recognized, which sounds correspond to which Program Change numbers, and the layout of rhythm sounds on the keyboard. Thanks to these specifications, any device that is equipped with sound sources supporting the General MIDI System will be able to accurately reproduce General MIDI Scores (music data created for the General MIDI System), regardless of the manufacturer or model.



GM emblem

#### The MT-120's GS Sound Source

The "GS" logo appears on the panel of the MT-120. This serves to indicate that the unit is equipped with a GS Format sound source.

The GS Format is a standardized set of specifications for Roland's sound sources which defines the manner in which multi-timbral sound generating units will respond to MIDI messages. The GS Format also complies with the General MIDI System.

The GS Format also defines a number of other details. These include unique specifications for sounds and the functions available for Tone editing and effects (chorus and reverb), and other specifications concerning the manner in which sound sources will respond to MIDI messages.



GS emblem

The MT-120 is a complete GS sound source when the Piano switch on the back of the device is set to Int. When the switch is set to Ext, Part 1 is used as receiving Channel 1 for a connected sound source device.

---

### About the Number of Sounds that can be Played Simultaneously

The MT-120's sound source can play 28 sounds at the same time. If data for a number larger than this is received, some sounds are omitted. Also, because some tones have more than one voice, the number of such tones that can be played simultaneously may be reduced.

The GS sound source gives priority to Parts as shown below. This Part priority determines which sounds are omitted when note data for more than the maximum number of sounds is received. Sounds are omitted starting with the Parts with the lowest priority. Use Parts with high priority for sounds in melodies or bass lines that you do not want dropped.

For information regarding the number of voices used by tones, see the "Tone List."

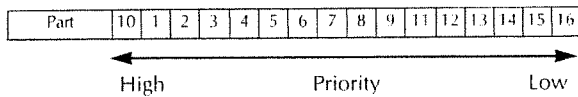

### About Songs made on the MT-120

When you make a song on the MT-120, GS reset data (a System Exclusive Message used only by GS) is inserted at the start of the song. When playing this song on another instrument with a GS sound source, the sound source is reset to its initial values.

Other song settings, such as the sounds of the Parts to be played (Program Changes) and volume are sent to the sound source before the song is played.

## 4. MIDI Diagram of the MT-120

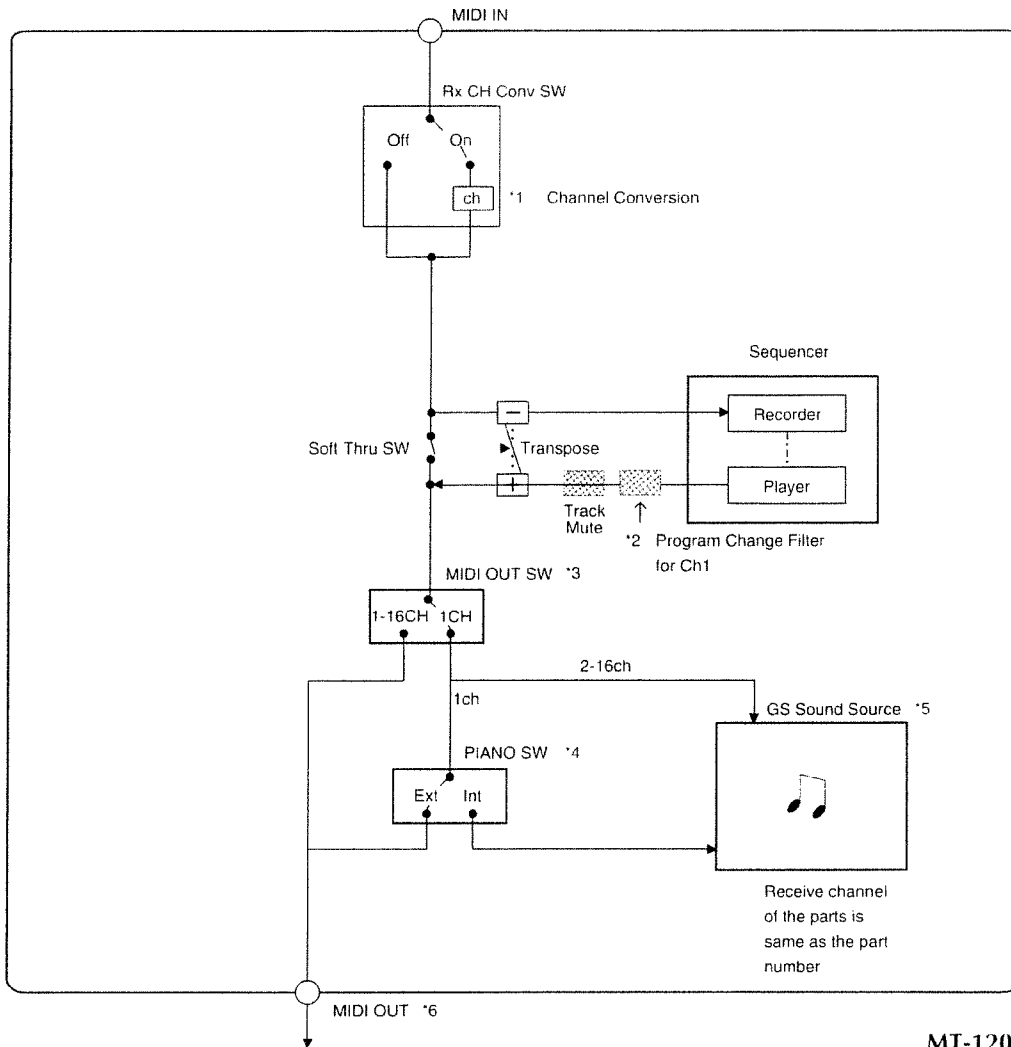

MT-120

\*1 When the Rx CH Conv switch is set to "On," the channel for messages entering through MIDI IN are converted to the channel for the Part number displayed when you press the [Sound] or [Minus One] button.

\*2 This is the filter for output of Program Change messages for Channel 1. When the PIANO switch on the back of the unit is set to "Int," the Program Change messages are output to the internal GS sound source, but output is cut off when this switch is set to "Ext."

\*3 When you set the MIDI OUT switch to "1-16CH," MIDI data for all channels is sent from MIDI OUT.

\*4 The rear panel Piano switch controls whether Channel 1 MIDI messages are sent to the MIDI OUT connector (Ext) or to the internal GS sound source (Int). If this is set to Ext, no tone assignment information (Program Change and Bank Select Messages) is output over transmit channel 1 when a song starts to playback.

\*5 The MIDI receive channel for each Part is just its Part number. Part 10 is reserved for drum sounds, and Program Change messages on Part 10 will select from among the various Drum Sets.

\*6 If the SOFT THRU switch is set to On (Off), when you turn on the power, a Local Off (On) message is sent from the MIDI OUT connector to channel 1. If a Roland piano is connected to the MT-120, then the piano automatically receives a Local Off (On) message when the power to the MT-120 is turned on.



## 5. MIDI Switching

This is where you can control how MIDI messages are received and transmitted by the MT-120.

Usually there will be no need to change these settings, but if you ever need to, here's how.

### How to Switch a Setting

- (1) While holding [Stop], press the [Disk/Tune] button.

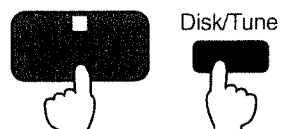

- (2) Press the [Value -] and [Value +] buttons until the parameter you want appears.

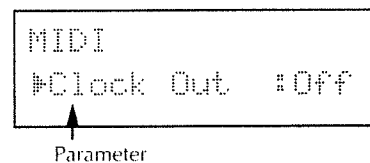
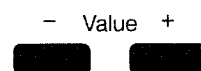

- (3) Press the [>] right cursor button, and make your setting with the [Value -] and [Value +] buttons.

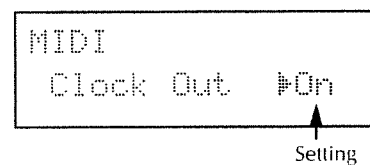

- (4) Press [Enter] to register the change.



## Switch Options

### **Sync** **Auto/Int/Ext/Remote**

This determines whether the sequencer functions according to the MT-120's tempo or according to the MIDI clock received at MIDI IN when you're playing or recording.

Select how you want the MT-120 to work when playing or recording. Normally, you should set this to "Auto."

When set to "Auto," you can use the [Value -] and [Value +] buttons to vary the tempo when you play the MT-120 alone, but if MIDI IN is connected to a sequencer and receives MIDI start data, then the MT-120 functions according to the information from the sequencer.

When set to "Int," you can use the [Value -] and [Value +] buttons to adjust the tempo.

When you set the switch to "Ext," you will no longer be able to start playing or recording with the MT-120. The MT-120 will start to function when you play the sequencer connected to MIDI IN.

When set to "Remote," you can use the [Value -] and [Value +] buttons to adjust the tempo. However, starting and stopping play on the MT-120 is controlled by the sequencer hooked up to MIDI IN.

### **Clock Out** **On/Off**

This selects whether or not MIDI sync messages will be transmitted via the MIDI OUT connector. Normally this is set to Off.

\* By MIDI sync, we mean MIDI Clock, Start, Stop, Continue, and Song Pointer messages.

### **Update** **On/Off**

Any time you use the [Bwd]/[Fwd] buttons, or jump to a Marker to start play at some point within a song, Update checks all the MIDI messages (except for Note Numbers) up to that point. It checks to see if there have been any changes in settings since the beginning of the song, so that the song will play the same as if you had not skipped ahead. If you set this to Off, only the previous two measure (bars) are checked for such messages.

### **Soft Thru** **On/Off**

With Piano SW sets to Ext, MIDI messages coming from the MIDI IN connector will be output at the MIDI OUT connector or not, depending on this switch.

When you turn this to On (Off), the Local Off (On) message is sent from the MIDI OUT.

If the piano won't let you turn the local setting to Off, switch Off this function.

### **Rx CH Conv** **On/Off**

This determines whether the channel for MIDI information sent from the external MIDI device is converted to the Part channel displayed when you press the [Sound] or [Minus One] button.

This is set to "On" when the MT-120 is shipped from the factory.

### **MIDI OUT** **1CH/1-16CH**

The setting of this switch determines whether MIDI data is sent to the built-in GS sound source (1CH) or out through MIDI OUT (1-16CH).

When set to "1CH," the data for channels 2 to 16 is sent to the GS sound source, but the setting of the Piano switch on the back of the MT-120 determines whether channel 1 data is sent to the GS sound source or out through MIDI OUT.

This switch is set to "1CH" when shipped from the factory.

# 7

## Appendix

7

<b>1. Contents of the Demo Song Disk .....</b>	<b>82</b>
Profiles of the Demo Song Composers .....	83
<b>2. Selecting Functions .....</b>	<b>84</b>
<b>3. Data List.....</b>	<b>85</b>
<b>4. Tone List.....</b>	<b>86</b>
<b>5. Troubleshooting .....</b>	<b>91</b>
<b>6. Messages .....</b>	<b>92</b>

# 1. Contents of the Demo Song Disk

## 1. Minuet in G (with Orchestra) 1: Minuet+Orch

Composer Anonymous (from J.S.Bach "Notebooks for Anna Magdalena Bach")

Piano Performed by Nigel Clayton

Accompaniment Arrangement & Music Data by Hiroshi

Hisamitsu Tempo: ♩ = 108 / Pick-up Measure : Yes

Introduction : 8 Measures

Track	R	1	2	3	4
	Drums & Percussion		Orchestra	Piano Left Hand	Piano Right Hand

## 2. "La Styrienne" from Burgmüller 25 Easy Studies

### Op.100 2: La Styrienne

Composed by J.F.F.Burgmüller

Arrangement & Music Data by Kaoru Mizuki

Tempo: ♩ = 158 / Pick-up Measure : Yes

Track	R	1	2	3	4
	Drums & Percussion		Orchestra	Piano Left Hand	Piano Right Hand

## 3. The Milky Way

### 3: Milky Way

Composed and Music Data by Masashi & Kazuko Hirashita

Tempo: ♩ = 130 / Pick-up Measure : No

Track	R	1	2	3	4
	Drums		Orchestra	Piano Left Hand	Piano Right Hand

## 4. Concertino

### 4: Concertino

Composed and Music Data by Alistair Jones

©1991 Roland Corporation (UK). All rights reserved.

Tempo: ♩ = 66 / Pick-up Measure : No

Track	R	1	2	3	4
	Percussion		Orchestra	Piano Left Hand	Piano Right Hand

## 5. Scrambled Eggs

### 5: ScrambledEgg

Composed and Music Data by Masashi & Kazuko Hirashita

Tempo: ♩ = 230 / Pick-up Measure : No

Track	R	1	2	3	4
	Drums		Bass	Piano Left Hand	Piano Right Hand

## 6. Sonic Groove

### 6: Sonic Groove

Composed and Music Data by Satoru Wono

Tempo: ♩ = 123 / Pick-up Measure : No

Track	R	1	2	3	4
	Drums & Percussion		Orchestra	Piano Left Hand	Piano Right Hand

## 7. Minuet in G (Piano Solo)

### 7: Minuet

Composer Anonymous (from J.S.Bach "Notebooks for Anna Magdalena Bach")

Piano Performed by Nigel Clayton

Tempo: ♩ = 150 / Pick-up Measure : No

Track	R	1	2	3	4
				Piano Left Hand	Piano Right Hand

## 8. Sicilienne (Accompaniment for Flute)

### 8: Sicilienne

Composed by Gabriel Faure

Music Data by Roland Corporation

Tempo: ♩ = 45 / Pick-up Measure : No

Track	R	1	2	3	4
			Flute	Piano (Accomp)	

## 9. DESERT SUNSET

9: DESERTSUNSET

Composed and Music Data by John Campbell

©1993 Evanhale Music. All rights reserved.

Tempo: ♩ = 95 / Pick-up Measure : No

Track	R	1	2	3	4
	Drums		Orchestra	Guitar 2	Guitar 1 (Melody)

## 10. UNCLE WIGLEY

10: UNCLE WIGLEY

Composed and Music Data by John Campbell

©1993 Evanhale Music. All rights reserved.

Tempo: ♩ = 135 / Pick-up Measure : No

Track	R	1	2	3	4
	Drums		Orchestra	Guitar 2	Guitar 1 (Melody)

## Profiles of the Demo Song Composers

### Nigel Clayton

Nigel Clayton graduated from the Royal College of Music in London, where he was the winner of many prizes for solo, duo and chamber music playing. Since finishing his studies he has toured America, the whole of Europe, the Middle East, India and Sri Lanka, playing with instrumentalists from all over the world including Korea, Japan, India, Canada and Spain. He regularly performs in major concert halls and on the B.B.C. radio network. He has recently recorded two commercial discs for Kingdom Records (U.K.) and Collins Classics. Nigel is the official accompanist for the Tibor Varga International Violin Competition in Switzerland.

### Hiroshi Hisamitsu

Hiroshi Hisamitsu was born in Kyoto, Japan. After graduating from the Kyoto City University of Arts Department of Music, he worked as a computer musician and programmer while establishing his own career in music composition and orchestration. Recently, as a member of a music production group called KHY (pronounced Kai), he has earned wide recognition as a performer, writer and music data producer. He is also capable of covering various musical styles from popular to classical.

### Kaoru Mizuki

Kaoru Mizuki started studying piano at the age of 5. While she was 15 years old, she started composing. After graduating from the Tokyo National University of Fine Arts and Music, majoring in composition, she received many awards and titles for compositions for chorus and horn ensembles. She is now pursuing her career in writing for TV programs and jingles. She has earned an enviable reputation for her compositions and has also released a CD in Japan.

### Masashi Hirashita / Kazuko Hirashita

Masashi and Kazuko both started studying classical piano when they were in their infancy. Both went on to study composition. At the same time, they had started their own music careers as keyboardists and composers. Their work covers a wide spectrum of styles and activities, including pop, fusion and jazz music as well as many writing and producing jobs.

### Alistair Jones

Alistair Jones is the Music Education Manager for Roland(UK). He is a composer, pianist and organist and conducts the London based 'Chiswick Choir' for whom he wrote his oratorio 'Dies Irae'. He composes mostly vocal music, having five song cycles and a number of choral pieces in his catalogue. His new choral work 'Carmen Paschalis', for chorus, soloists and full orchestra is due to be premiered in London in 1993/94. Prior to joining the UK's music industry, he was for sixteen years a school teacher.

### Satoru Wono

While studying at the Tokyo Gakugei University, where he gained his Bachelor of Music Degree and M.E., he worked as a composer and performer. A modern composition, "The Machine of The Bachelor", received Best New Composer Award from the Japanese Society of Contemporary Music in 1988. He is also very active as a producer of House music and is a composer of video and TV music.

### John Campbell

John Campbell is an award-winning Los Angeles, California based composer, keyboardist and producer. As a keyboard player, his long list of credits include working with artists such as Philip Bailey, Larry Carlton, Mel Tormé, and the group "Chicago". As a composer, John has written music for a wide variety of television, film and radio projects. John has become a regular spokesperson for Roland Corporation while utilizing his experience as a dynamic performing musician, composer, and educator.

© © 1993 Roland Corporation. All rights reserved.

Unauthorized duplication, reproduction, hiring, lending, public performance and broadcasting is prohibited.

## 2. Selecting Functions

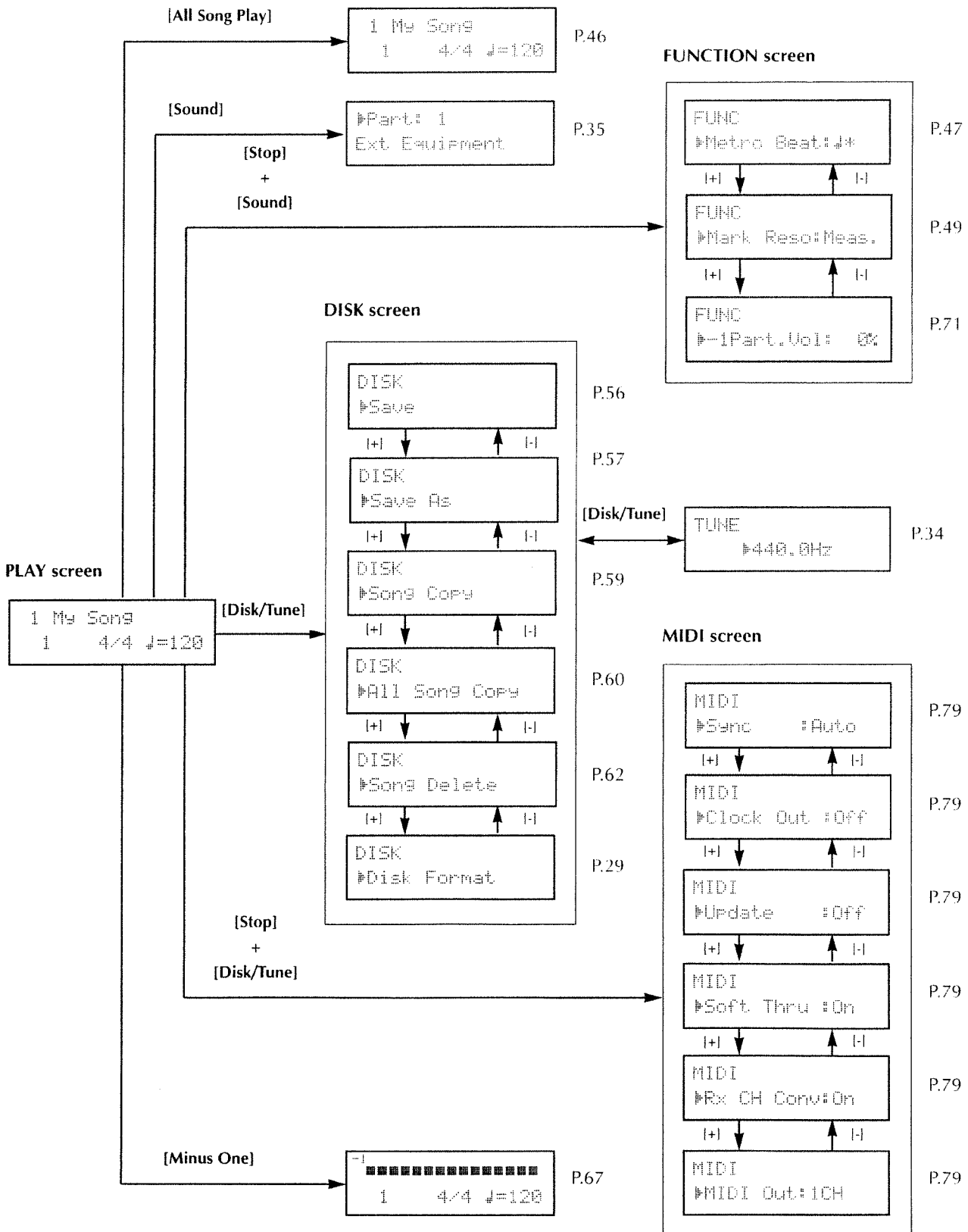

# 3. Data List

## 1. Song-Dependent Settings

### Settings Saved with the Song

Parameters	Values	Default	Page
Marker A/B	Various points in song		21, 48
Tempo *1	quarter note=20—250 bpm	120	17
Beat *1	1/2—4/2, 1/4—8/4, 1/8—16/8, 1/16—32/16	4/4	27
Sound *2			
Part 1 Tone	See Tone List (page 72)	1-0 Piano	35
Part 2 Tone	See Tone List	33-0 Acoustic Bs.	35
Part 3 Tone	See Tone List	49-0 Strings	35
Part 4 Tone	See Tone List	66-0 Alto sax	35
Part 5 Tone	See Tone List	25-0 Nylon-str. Gt	35
Part 6 Tone	See Tone List	74-0 Flute	35
Part 7 Tone	See Tone List	62-0 Brass 1	35
Part 8 Tone	See Tone List	20-0 Church Org. 1	35
Part 9 Tone	See Tone List	89-0 Fantasia	35
Part 10 Tone	See Drum Set List (page 77)	1 Standard	35
Part 11 Tone	See Tone List (page 72)	48-0 Timpani	35
Part 12 Tone	See Tone List	10-0 Glockenspiel	35
Part 13 Tone	See Tone List	83-0 Syn.Calliope	35
Part 14 Tone	See Tone List	104-0 Star Theme	35
Part 15 Tone	See Tone List	105-0 Sitar	35
Part 16 Tone	See Tone List	124-0 Bird	35
All parts Vol	0—127	100	36
R, 1—4 Track data		None	24

### Revert to Default if a Song is Reloaded Without Being Saved

Parameters	Values	Default	Page
R, 1—4 Track Mute	On/Off	Off	18
Tempo Track Mute	On/Off	Off	19

## 2. Song-Independent Settings

### Retained Even if Power is Turned Off

Parameters	Values	Default	Page
MIDI			
Sync	Auto/Int/Ext/Remote	Auto	80
Clock Out	On/Off	Off	80
Update	On/Off	Off	80
Soft Thru	On/Off	On	80
Rx CH Conv SW	On/Off	On	80
MIDI OUT SW	1CH/1-16CH	1CH	80
TUNE	415.4—466.1 Hz	440.0 Hz	34

### Revert to Default when the Power is Turned On

Parameters	Values	Default	Page
Metronome	On/Off	Off	19
Count In	On/Off	Off	20
Repeat	On/Off	Off	21
Transpose	-24—24	0	16

\*1 Indicates that this value is saved only if the change is made after pressing the [Rec] button, then record. Otherwise, the changes are not saved, and when the song is recalled, these values revert to their original settings.

\*2 Indicates that this value is saved only if there is a Write operation after the change is made. Otherwise, it is not saved and the values revert to their original settings. When playing back from the top of Measure 1, these revert to their original settings.

## 4. Tone List

	I#	V#	Tone Name	Voice
Piano	1	0	Piano 1	1
		8	Piano 1w	2
		16	Piano 1d	1
	2	0	Piano 2	1
		8	Piano 2w	2
	3	0	Piano 3	1
		8	Piano 3w	2
	4	0	Honky-tonk	2
		8	Honky-tonk w	2
	5	0	E.Piano 1	1
		8	Detuned EP 1	2
		16	E.Piano 1v	2
		24	60's E.Piano	1
	6	0	E.Piano 2	1
		8	Detuned EP 2	2
		16	E.Piano 2v	2
7	0	Harpsichord	1	
	8	Coupled Hps.	2	
	16	Harpsi.w	2	
	24	Harpsi.o	2	
8	0	Clav.	1	
Chromatic Percussion	9	0	Celesta	1
	10	0	Glockenspiel	1
	11	0	Music Box	1
	12	0	Vibraphone	1
		8	Vib.w	2
	13	0	Marimba	1
		8	Marimba w	2
	14	0	Xylophone	1
	15	0	Tubular-bell	1
		8	Church Bell	1
9		Carillon	1	
16	0	Santur	1	

	I#	V#	Tone Name	Voice
Organ	17	0	Organ 1	1
		8	Detuned Or.1	2
		16	60's Organ 1	1
		32	Organ 4	2
	18	0	Organ 2	1
		8	Detuned Or.2	2
		32	Organ 5	2
	19	0	Organ 3	2
	20	0	Church Org.1	1
		8	Church Org.2	2
		16	Church Org.3	2
	21	0	Reed Organ	1
	22	0	Accordion Fr	2
		8	Accordion It	2
	23	0	Harmonica	1
	24	0	Bandoneon	2
Guitar	25	0	Nylon-str.Gt	1
		8	Ukulele	1
		16	Nylon Gt.o	2
		32	Nylon.Gt.2	1
	26	0	Steel-str.Gt	1
		8	12-str.Gt	2
		16	Mandolin	1
	27	0	Jazz Gt.	1
		8	Hawaiian Gt.	1
	28	0	Clean Gt.	1
		8	Chorus Gt.	2
	29	0	Muted Gt.	1
		8	Funk Gt.	1
		16	Funk Gt.2	1
	30	0	Overdrive Gt	1
	31	0	DistortionGt	1
8		Feedback Gt.	2	
32	0	Gt.Harmonics	1	
	8	Gt. Feedback	1	

I# Instrument Number (Program Number)  
 V# Variation Number (Control Number 0)



	I#	V#	Tone Name	Voice
Bass	33	0	Acoustic Bs.	1
	34	0	Fingered Bs.	1
	35	0	Picked Bs.	1
	36	0	Fretless Bs.	1
	37	0	Slap Bass 1	1
	38	0	Slap Bass 2	1
	39	0	Synth Bass 1	1
		1	SynthBass101	1
		8	Synth Bass 3	1
	40	0	Synth Bass 2	2
8		Synth Bass 4	2	
16		Rubber Bass	2	
Strings/Orchestra	41	0	Violin	1
		8	Slow Violin	1
	42	0	Viola	1
	43	0	Cello	1
	44	0	Contrabass	1
	45	0	Tremolo Str	1
	46	0	PizzicatoStr	1
	47	0	Harp	1
48	0	Timpani	1	
Ensemble	49	0	Strings	1
		8	Orchestra	2
	50	0	Slow Strings	1
	51	0	Syn.Strings1	1
		8	Syn.Strings3	2
	52	0	Syn.Strings2	2
	53	0	Choir Aahs	1
		32	Choir Aahs 2	1
	54	0	Voice Oohs	1
55	0	SynVox	1	
56	0	OrchestraHit	2	

	I#	V#	Tone Name	Voice
Brass	57	0	Trumpet	1
	58	0	Trombone	1
		1	Trombone 2	2
	59	0	Tuba	1
	60	0	MutedTrumpet	1
	61	0	French Horn	2
		1	Fr.Horn 2	2
	62	0	Brass 1	1
		8	Brass 2	2
		0	Synth Brass1	2
	63	8	Synth Brass3	2
		16	AnalogBrass1	2
		0	Synth Brass2	2
	64	8	Synth Brass4	1
		16	AnalogBrass2	2
		65	0	Soprano Sax
Reed	66	0	Alto Sax	1
	67	0	Tenor Sax	1
	68	0	Baritone Sax	1
	69	0	Oboe	1
	70	0	English Horn	1
	71	0	Bassoon	1
	72	0	Clarinet	1
	73	0	Piccolo	1
Pipe	74	0	Flute	1
	75	0	Recorder	1
	76	0	Pan Flute	1
	77	0	Bottle Blow	2
	78	0	Shakuhachi	2
	79	0	Whistle	1
	80	0	Ocarina	1
	Synth Lead	81	0	Square Wave
1			Square	1
8			Sine Wave	1
82		0	Saw Wave	2
		1	Saw	1
		8	Doctor Solo	2
83		0	Syn.Calliope	2
84		0	Chiffer Lead	2
85		0	Charang	2
86		0	Solo Vox	2
87		0	5th Saw Wave	2
88		0	Bass & Lead	2

I# Instrument Number (Program Number)  
V# Variation Number (Control Number 0)

	I#	V#	Tone Name	Voice
Synth Pad	89	0	Fantasia	2
	90	0	Warm Pad	1
	91	0	Polysynth	2
	92	0	Space Voice	1
	93	0	Bowed Glass	2
	94	0	Metal Pad	2
	95	0	Halo Pad	2
	96	0	Sweep Pad	1
Synth SFX	97	0	Ice Rain	2
	98	0	Soundtrack	2
	99	0	Crystal	2
		1	Syn Mallet	1
	100	0	Atmosphere	2
	101	0	Brightness	2
	102	0	Goblin	2
	103	0	Echo Drops	1
		1	Echo Bell	2
		2	Echo Pan	2
104	0	Star Theme	2	
Ethnic	105	0	Sitar	1
		1	Sitar 2	2
	106	0	Banjo	1
	107	0	Shamisen	1
	108	0	Koto	1
		8	Taisho Koto	2
	109	0	Kalimba	1
	110	0	Bag Pipe	1
111	0	Fiddle	1	
112	0	Shanai	1	
Percussive	113	0	Tinkle Bell	1
	114	0	Agogo	1
	115	0	Steel Drums	1
	116	0	Woodblock	• 1
		8	Castanets	• 1
	117	0	Taiko	• 1
		8	Concert BD	• 1
	118	0	Melo. Tom 1	• 1
		8	Melo. Tom 2	• 1
	119	0	Synth Drum	• 1
8		808 Tom	• 1	
9		Elec Perc 1	• 1	
120	0	Reverse Cym.	• 1	

	I#	V#	Tone Name	Voice
SFX	121	0	Gt.FretNoise	• 1
		1	Gt.Cut Noise	• 1
		2	String Slap	• 1
	122	0	Breath Noise	1
		1	Fl.Key Click	• 1
	123	0	Seashore	• 1
		1	Rain	• 1
		2	Thunder	• 1
		3	Wind	• 1
		4	Stream	• 2
	124	5	Bubble	• 2
		0	Bird	• 2
		1	Dog	• 1
		2	Horse-Gallop	• 1
	125	3	Bird 2	• 1
		0	Telephone 1	• 1
		1	Telephone 2	• 1
		2	DoorCreaking	• 1
		3	Door	• 1
	126	4	Scratch	• 1
		5	Windchime	• 2
		0	Helicopter	• 1
		1	Car-Engine	• 1
		2	Car-Stop	• 1
		3	Car-Pass	• 1
		4	Car-Crash	• 2
		5	Siren	• 1
		6	Train	• 1
	7	Jetplane	• 2	
	127	8	Starship	• 2
9		Burst Noise	• 2	
0		Applause	• 2	
1		Laughing	• 1	
2		Screaming	• 1	
3		Punch	• 1	
4		Heart Beat	• 1	
5		Footsteps	• 1	
128		0	Gun Shot	• 1
	1	Machine Gun	• 1	
	2	Lasergun	• 1	
	3	Explosion	• 2	

I# Instrument Number (Program Number)

V# Variation Number (Control Number 0)

- Tones marked with a • have an indeterminate pitch since they are percussion instrument or sound effects. Please use a key around C4 (Key #60).

## Drum Set List

Note Number	I#1:STANDARD Set I#33:JAZZ Set	I#9:ROOM Set	I#17:POWER Set	I#25: ELECTRONIC Set	I#26:TR-808 Set	I#41: BRUSH Set	I#49:ORCHESTRA Set
27	High Q						Closed HH [EXC1]
28	Slap						Pedal HH [EXC1]
29	Scratch Push [EXC7]						Open HH [EXC1]
30	Scratch Pull [EXC7]						Ride Cymbal
31	Sticks						
32	Square Click						
33	Metronome Click						
34	Metronome Bell						
35	Kick Drum 2 / JAZZ BD 2					JAZZ BD 2	Concert BD 2
36	Kick Drum 1 / JAZZ BD 1		MONDO Kick	Elec BD	808 Bass Drum	JAZZ BD 1	Concert BD 1
37	Side Stick				808 Rim Shot		
38	Snare Drum 1		Gated SD	Elec SD	808 Snare Drum	Brush Tap	Concert SD
39	Hand Clap					Brush Slap	Castanets
40	Snare Drum 2			Gated SD		Brush Swirl	Concert SD
41	Low Tom 2	Room Low Tom 2	Room Low Tom 2	Elec LowTom 2	808 Low Tom 2		Timpani F
42	Closed Hi-Hat [EXC1]				808 CHH [EXC1]		Timpani F#
43	Low Tom 1	Room Low Tom 1	Room Low Tom 1	Elec LowTom 1	808 Low Tom 1		Timpani G
44	Pedal Hi-Hat [EXC1]				808 CHH [EXC1]		Timpani G#
45	Mid Tom 2	Room Mid Tom 2	Room Mid Tom 2	Elec MidTom 2	808 Mid Tom 2		Timpani A
46	Open Hi-Hat [EXC1]				808 OHH [EXC1]		Timpani A#
47	Mid Tom 1	Room Mid Tom 1	Room Mid Tom 1	Elec MidTom 1	808 Mid Tom 1		Timpani B
48	High Tom 2	Room Hi Tom 2	Room Hi Tom 2	Elec Hi Tom 2	808 Hi Tom 2		Timpani c
49	Crash Cymbal 1				808 Cymbal		Timpani c#
50	High Tom 1	Room Hi Tom 1	Room Hi Tom 1	Elec Hi Tom 1	808 Hi Tom 1		Timpani d
51	Ride Cymbal 1						Timpani d#
52	Chinese Cymbal			Reverse Cymbal			Timpani e
53	Ride Bell						Timpani f
54	Tambourine						
55	Splash Cymbal						
56	Cowbell				808 Cowbell		
57	Crash Cymbal 2						Concert Cymbal2
58	Vibra-slap						
59	Ride Cymbal 2						Concert Cymbal1
60	High Bongo						
61	Low Bongo						
62	Mute High Conga				808 Hi Conga		
63	Open High Conga				808 Mid Conga		
64	Low Conga				808 Low Conga		
65	High Timbale						
66	Low Timbale						
67	High Agogo						
68	Low Agogo						
69	Cabasa						
70	Maracas				808 Maracas		
71	Short Hi Whistle [EXC2]						
72	Long Low Whistle [EXC2]						
73	Short Guiro [EXC3]						
74	Long Guiro [EXC3]						
75	Claves				808 Claves		
76	High Wood Block						
77	Low Wood Block						
78	Mute Cuica [EXC4]						
79	Open Cuica [EXC4]						
80	Mute Triangle [EXC5]						
81	Open Triangle [EXC5]						
82	Shaker						
83	Jingle Bell						
84	----						
85	Castanets						
86	Mute Surdo [EXC6]						
87	Open Surdo [EXC6]						
88	----	----	----	----	----	----	Applause *

I# Instrument number  
 \* Tones which are created with using two voices.  
 (All other tones are created with one voice.)

Blank Same as the percussion sound of "STANDARD" set  
 ---- No sound  
 [EXC] Percussion sound of the same number will not be heard at the same time.

## SFX Set

Note Number	I#57:SFX Set
39	High Q
40	Slap
41	Scratch Push [EXC7]
42	Scratch Pull [EXC7]
43	Sticks
44	Square Click
45	Metronome Click
46	Metronome Bell
47	Guitar sliding finger
C3 48	Guitar cutting noise (down)
49	Guitar cutting noise (up)
50	String slap of double bass
51	Fl. Key Click
52	Laughing
53	Screaming
54	Punch
55	Heart Beat
56	Footsteps 1
57	Footsteps 2
58	Applause *
59	Door Creaking
C4 60	Door
61	Scratch
62	Windchime *
63	Car-Engine
64	Car-Stop
65	Car-Pass
66	Car-Crash *
67	Siren
68	Train
69	Jetplane *
70	Helicopter
71	Starship *
C5 72	Gun Shot
73	Machine Gun
74	Lasergun
75	Explosion *
76	Dog
77	Horse-Gallop
78	Birds *
79	Rain *
80	Thunder
81	Wind
82	Seashore
83	Stream *
C6 84	Bubble *

\* Tones which are created with using two voices.  
(All other tones are created with one voice.)

[EXC] Percussion sounds of the same number cannot be heard at the same time.

---

## 5. Troubleshooting

### "It won't play at all"

Are both the piano and the MT-120 turned on? (page 13)

Is the MT-120 volume slider turned all the way down? (page 15, 25)

Are the MIDI cables and audio cables hooked up as shown in the connection diagram? (page 12)

Is a Track Mute turned on? (page 18)

Is a Part Mute turned on? (page 36)

Is the MIDI OUT switch set to 1-16CH? (page 80)

Is the volume on the part being played turned down? (page 36)

Is it just one key that won't sound? Depending on the tone, sometimes the number of notes can exceed what the tone generator can play at one time.

### "I can't get the digital piano to play"

Are both the piano and the MT-120 turned on? (page 13)

Is the piano volume turned all the way down?

Is the Piano switch on the back of the MT-120 set to Int? (page 13)

Is the piano MIDI transmit/receive channel set to 1? (page 13)

Are the MIDI cables and audio cables hooked up as shown in the connection diagram? (page 12)

Is Track Mute turned on? (page 18)

Is the Soft Thru switch on the MT-120 turned off? (page 80)

### "I can hear the piano, but it sounds like it has some noise in it"

Did you turn on the connected piano first?

If you do that and the problem persists, turn the local setting on the piano to Off.

If the piano won't let you do this, switch Off the MT-120's Soft Thru function (page 79).

### "It starts sounding funny halfway through playback of a song"

This can happen when you jump to a new position in the song partway through playback. You can prevent this by having MIDI Update set to On (although in this case you might notice a slight delay between the time you press the [Play] button and the time playback actually starts) (page 80).

### "It's completely out of tune"

If the overall pitch of the MT-120 is off, tune up with the Master Pitch setting. (page 34)

Otherwise, check to see if Transpose is On. (page 16)

### "I can't hear the metronome"

Is it turned on? (page 19)

Is the metronome volume on the back of the MT-120 turned down all the way? (page 4)

### "I don't hear a Count-In"

Is it turned on? (page 20)

Is the MT-120 volume slider turned down all the way? (page 15, 25)

Is the MT-120 MIDI OUT switch set to 1-16CH? (page 80)

Is the rhythm part (10) drum set selected as SFX? If so, this drum set will not play the Count-In notes. (page 35)

Is the Rhythm Part (10) volume turned down all the way? (page 36)

# 6. Messages

Improper Disk

**Cause:** The MT-120 can't read the disk that was inserted into the disk drive.  
**What to do:** Press [Stop].

Disk Read Error

**Cause:** Data can't be read from the disk, perhaps because it is damaged.  
**What to do:** Press [Stop].

Disk Write Error  
Save Failed

↑  
Save/Delete/Format/Copy

**Cause:** A Save, Delete, Format or Copy operation can't be performed, perhaps because the disk is damaged.  
**What to do:** Press [Stop].

W. Protect Disk  
Can Not Save

↑  
Save/Delete/Format/Copy

**Cause:** A Save, Delete, Format or Copy operation can't be performed, probably because the disk's write protect tab is set to PROTECT.  
**What to do:** Press [Stop].  
 Remove the disk from the drive and slide the write protect tab to the WRITE position. Try again.

Master Disk  
Can Not Save

↑  
Save/Delete/Format/Copy

**Cause:** The Demo Disk that came with your MT-120, the ism music data, and the SMF Music Data disks (which are sold separately), are Master Disks. This means they are write protected, and you will be unable to alter their contents in any way.  
**What to do:** Press [Stop].

SMF Disk  
Can Not Save

↑  
Save/Delete/Copy

**Cause:** The disk you are trying to Save or Copy to is a Standard MIDI File disk.  
**What to do:** Press [Stop]. Insert a disk formatted specifically for the MT-120 and try the operation again.

Disk Full  
Can Not Save

↑  
Save/Copy

**Cause:** There is no more room in the disk's memory, so you can't Save or Copy anything more to it.  
**What to do:** Press [Stop].

Not User Disk  
Can Not Save

↑  
Save/Delete/Copy

**Cause:** A Save can't be performed because the disk you are trying to Save or Copy to has not been formatted for the MT-120.  
**What to do:** Press [Stop]. Insert a disk formatted specifically for the MT-120 and try the operation again.

Different Disk  
Can Not Save

↑  
Save/Copy

**Cause:** The Songs on the Demo Disk are Protect Type M songs, and some songs on ism music data disks or SMF Music Data disks (which are sold separately) are also Protect Type M. This message appears when, after Saving a song from a Protect Type M disk onto an MT-120 disk (marked <1>, below), you try to Save or Copy that song again onto yet another MT-120 disk (marked <2>, below).  
 (Note that it is possible to Copy or Save the song anywhere within disk <1> itself.)

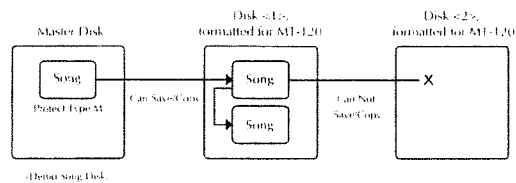

**What to do:** Press [Stop].

Protected Song  
Can Not Save

↑  
Save/Copy

**Cause:** You are trying to Save or Copy a Protect Type P ism music data song or standard MIDI file onto another disk (Protect Type P data cannot be Copied or Saved).

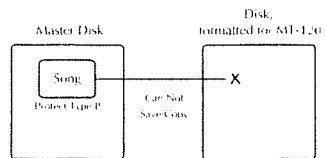

**What to do:** Press [Stop].

Read Only Song  
Can Not Save

↑  
Save/Delete/Copy

**Cause:** You can't Save, Delete or Copy this song because it has been made Read Only by MS-DOS.  
**What to do:** Press [Stop].

---

Memory Full  
Can Not Play

**Cause:** The Standard MIDI File data that you are trying to play is too large to fit in memory.  
**What to do:** Press [Stop].

Can Not Play  
This Data Format

**Cause:** The MT-120 does not recognize the file format which the current Standard MIDI File is stored in.  
**What to do:** Press [Stop].

Data will be  
erased. OK?

**Cause:** You are trying to load in a new song (or Copy a song from disk) before having Saved the results of a previous Record or Edit, which is still in the MT-120's memory. This message is asking if it's OK to erase the contents in memory.  
**What to do:** If you want to save the current data, press [Stop] and perform a Save operation. Otherwise, press [Enter] and the data will be erased.

Memory Full  
Recording Stop

**Cause:** The MT-120's internal memory is full, and anything recorded after this point is lost. (Memory capacity of the MT-120 is around 42,000 notes.)  
**What to do:** Press [Stop].

## MIDI Implementation Chart

Function***		Transmitted	Recognized	Remarks
<b>Basic Channel</b>	Default Changed	1, x, 1-16 x	1-16 x	No basic channel. Can be stored.
<b>Mode</b>	Default Messages Altered	Mode 3 *2 Mode 3 *****	x x	
<b>Note Number</b>	True Voice	*1 0-127 *****	0-127 0-127	
<b>Velocity</b>	Note ON Note OFF	*1 *1	o o	
<b>After Touch</b>	Key's Ch's	*1 *1	o o	
<b>Pitch Bend</b>		*1	o	
<b>Control Change</b>		0,32 *1 1 *1 5 *1 6, 38 *1 7 *1 10 *1 11 *1 64 *1 65 *1 66 *1 67 *1 91 *1 93 *1 98,99 *1 100, 101 *1 other(2-119) *1 120 *1 121 *1	o o o o o o o o o o o (Reverb) o (Chorus) o o o o o o o o o o o	Bank Select Modulation Portamento Time Data entry Volume Panpot Expression Hold 1 Portamento Sostenuto Soft Effect 1 Effect 3 NRPN LSB, MSB RPN LSB, MSB  All Sound Off Reset All Controllers
<b>Prog Change</b>	True #	*1 *4 0-127 *****	o 0-127	
<b>System Exclusive</b>		*1	o	
<b>System Common</b>	Song Pos Song Sel True	*3 x x	*5 x x	
<b>System Real Time</b>	Clock Commands	*3 *3	*6 *5	
<b>AUX Messages</b>	Local ON/OFF All Notes OFF Active Sense Reset	*2 x *1 x	x o (123-127) o x	
<b>Notes</b>		*1 Able to choose between "o" and "x" by MIDI OUT (1CH/1-16CH). Piano SW (Ext/Int). *2 When turn on the power, the OMNI OFF, POLY ON and LOCAL messages are sent to channel 1. *3 Able to choose between "o" and "x" by Clock Out (On/Off). *4 "x" when MIDI OUT is set to 1CH and Piano SW is set to Ext. *5 "o" when Sync is set to Auto, Ext or Remote. *6 "o" when Sync is set to Auto or Ext.		

Mode 1 : OMNI ON, POLY  
 Mode 3 : OMNI OFF, POLY

Mode 2 : OMNI ON, MONO  
 Mode 4 : OMNI OFF, MONO

o : Yes  
 x : No



# MIDI Implementation Chart

Function***		Transmitted	Recognized	Remarks
<b>Basic Channel</b>	Default	x	1-16	
	Changed	x	1-16	
<b>Mode</b>	Default	x	Mode 3	*1
	Messages Altered	x *****	Mode 3, 4 (M=1)	
<b>Note Number</b>	True Voice	x	0-127	
		*****	0-127	
<b>Velocity</b>	Note ON	x	o	
	Note OFF	x	x	
<b>After Touch</b>	Key's	x	o	
	Ch's	x	o	
<b>Pitch Bend</b>		x	o	
<b>Control Change</b>	0.32	x	o	Bank Select
	1	x	o	Modulation
	5	x	o	Portamento Time
	6.38	x	o	Data Entry
	7	x	o	Volume
	10	x	o	Panpot
	11	x	o	Expression
	64	x	o	Hold1
	65	x	o	Portamento
	66	x	o	Sostenuto
	67	x	o	Soft
	91	x	o (Reverb)	Effect 1
	93	x	o (Chorus)	Effect 3
	98,99	x	o	NRPN LSB, MSB
	100,101	x	o	RPN LSB, MSB
other(2-119)	x	o	All Sound Off	
120	x	o	Reset All Controllers	
121	x	o		
<b>Prog Change</b>	True #	x	o	Program Number 1-128
		*****	0-127	
<b>System Exclusive</b>		x	o	
<b>System Common</b>	Song Pos	x	x	
	Song Sel	x	x	
	True	x	x	
<b>System Real Time</b>	Clock	x	x	
	Commands	x	x	
<b>AUX Messages</b>	Local ON/OFF	x	x	
	All Notes OFF	x	o (123-125)	
	Active Sense	x	o	
	Reset	x	x	
<b>Notes</b>		*1 Recognize as M=1 even if M≠1.		

Mode 1 : OMNI ON, POLY  
 Mode 3 : OMNI OFF, POLY

Mode 2 : OMNI ON, MONO  
 Mode 4 : OMNI OFF, MONO

o : Yes  
 x : No

---

# Specifications

## MT-120

### <Sequencer Section>

#### Song Data:

Internal Memory

1 Song, Approx. 42,000 notes

Disk

99 Songs, Approx. 240,000 notes (2HD/1.44MB)

#### Disk Drive:

3.5 inch micro floppy disk drive

(2DD/720KB 2HD/1.44MB)

**Tracks:** 5 (4 + Rhythm)

**Song Length:** 999 measures

**Maximum simultaneous input notes (when recording):** 32

**Maximum simultaneous output notes (during playback):** 60

**Resolution:** 120 ticks /Quarter note

**Tempo:** Quarter note = 20 to 250 bpm

**Sync:** MIDI

### <Sound Source>

(General MIDI System / GS Format Sound Source)

**Maximum Polyphony:** 28 voices

**Number of Parts:** 16

**Number of Tones:** 226

**Number of Drum Sets:** 9 (8 + SFX Set)

### <Hardware>

**Display:** 16 characters; 2 lines

#### Connectors:

Two MIDI Connectors (IN/OUT)

Two Output Jacks (L/R)

Two Input Jacks (L/R)

Phones Jack (Stereo)

Start/Stop Control Jack

AC Adaptor Jack (DC9V)

#### Power Supply:

DC9V : AC Adaptor

#### Current Draw :

1,000mA

#### Dimensions:

305(W) x 245(D) x 65(H) mm

12 1/16(W) x 9 11/16(D) x 2 9/16(H) inches

#### Weight:

2.0 kg (excluding the AC Adaptor)

4lbs 7oz

### <Accessories>

Owner's Manual

Supplement

Demo Song Disk

Two MIDI Cables (1m)

Audio Cable

DC/DC Cable

AC Adaptor

The specifications and/or appearance of this product are subject to change without prior notice.

# Index

## "How-To" Index

Copy		
	All Songs on a disk.....	59
	Song on a disk .....	60
Disk		
	Copying a Song onto.....	59
	Copying all Songs onto .....	60
	Deleting Songs on .....	62
	Formatting .....	29
	Handling.....	9
	Saving a new Song to.....	31, 57
	Saving a Song to .....	56
Erase		
	Deleting Songs on a disk.....	62
Mark		
	Deleting.....	21, 50
	Jumping to .....	50
	Setting .....	21, 48
	Marker Resolution.....	49
Metronome		
	Changing the resolution .....	47
	Playing with.....	19
	Recording with .....	22
MIDI		
	Clock Out .....	80
	Diagram.....	78
	Rx CH Conv SW .....	80
	MIDI OUT SW .....	80
	Soft Thru .....	80
	Switching.....	79
	Sync .....	80
	Update.....	80
	What is MIDI?.....	74
Music Minus One		
	Adjusting the Volume for a Minus One Part .....	71
	Mute left hand Part .....	18
	Mute right hand Part .....	18
	Using a Guitar or Keyboard .....	69
	Using a MIDI Keyboard .....	67
Part		
	Executing the settings for .....	36
	Tone selection for.....	35
	Volume changes for .....	36
	Part Mute .....	36
Playback		
	Count in .....	20
	ism music data.....	64
	Minus One Play .....	67
	Repeat .....	21, 40
	Songs on a disk one after another.....	46
	Standard MIDI Files .....	65
	Start/Stop using a pedal.....	15
	Starting .....	15
	Starting again from the beginning.....	16
	Starting from the middle of a Song .....	16
	Stopping .....	15
	Sync with an external device .....	52
	With the Metronome.....	19
Power		
	Off.....	32
	On .....	13
Recording		
	Adding data as the pattern plays over and over .....	40
	Each Part.....	38
	Left hand.....	24
	New Song .....	26, 38
	Pickup notes .....	51
	Re-recording .....	23, 41
	Right hand .....	22
	Starts after Count in .....	27
	Starts with 'key on'.....	28
	With the Metronome.....	26
Song		
	Blank selection of .....	26, 38
	Naming.....	29, 57
	Selection of.....	14, 17
Sound Source		
	GM System .....	76
	GS Format.....	76
	Maximum polyphony.....	77

Tempo	
Changing .....	17
Mute changes in .....	19
Returning to original .....	19
Transpose	
Temporary .....	16
Volume	
MT-120 .....	15, 25
Part .....	36

## Index of Functions

### A

All Song Copy .....	60
All Song Play .....	46

### B

Beat .....	27
Bwd .....	16

### C

Clock Out .....	80
Count In .....	20

### D

Disk/Tune .....	55/34
-----------------	-------

### F

Format .....	29
Fwd .....	16

### M

Marker .....	21, 48
Marker Clear .....	21, 50
Mark Reso .....	49
Metro Beat .....	47
Metronome .....	19
Metronome knob .....	19
MIDI .....	74
MIDI connectors .....	74
MIDI OUT SW .....	80
Minus One .....	67
Minus One Part Volume .....	71

### O

Output jacks .....	12
--------------------	----

### P

Part .....	35
Piano switch .....	13
Play .....	15

### R

Rec .....	22
Repeat .....	21, 40
Reset .....	16
Rx CH Conv SW .....	80

### S

Save .....	56
Save As .....	31, 57
Soft Thru .....	80
Solo .....	68
Song .....	14
Song Copy .....	59
Song Delete .....	62
Start/Stop jack .....	15
Stop .....	15
Sync .....	80

### T

Tempo .....	17
Tempo Mute .....	19
Track .....	18
Transpose .....	16

### U

Update .....	80
--------------	----

### V

Value .....	5
Volume slider .....	25

# Minuet in G

Anonymous  
BWW, Anh. 114

Allegretto

Cut off at the perforated line.

5 4 1 4 2 1 3

*p*

2 4 2 4 1 5

1 1 4 1 3 4

*mf*

4 3 1 4 2 1 5 1

5 1 2 1 5 1 2 1 5 1 2 3 4

*p*

3 2 3 1

1 1 3 1 4 5 1

*poco rit.*

5 3 4 2 1 4 2 1 2 5

# Playing with Count-In On or Off

## Play with Count-In On

When started at the beginning of the song

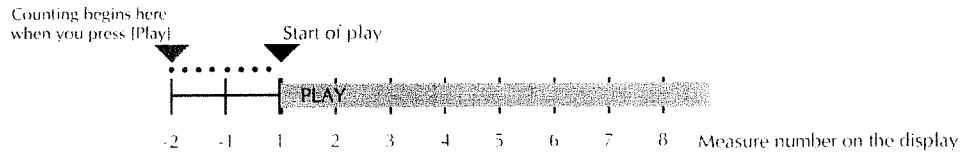

When started at the beginning of the fifth bar

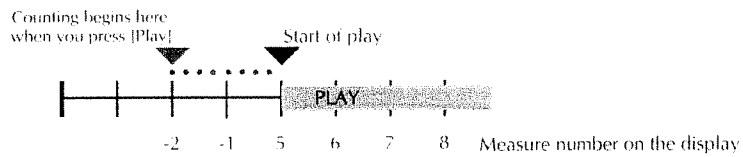

When started in the middle of the fifth bar

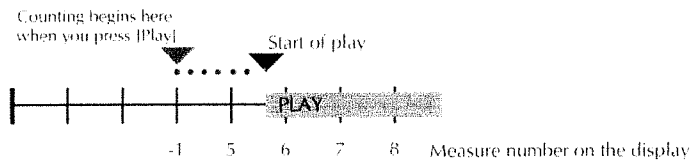

## Play with Count-In Off

When started at the beginning of the song

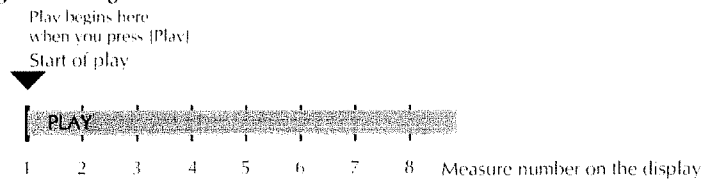

When started at the beginning of the fifth bar

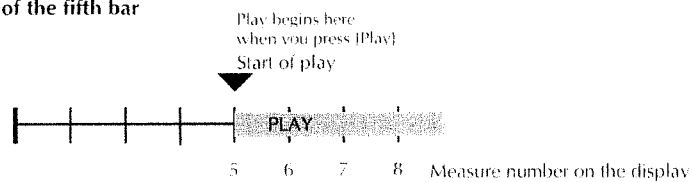

When started in the middle of the fifth bar

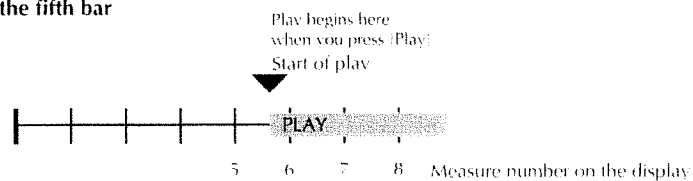

# Recording with Count-In On or Off

## Recording with Count-In On

When started at the beginning of the song

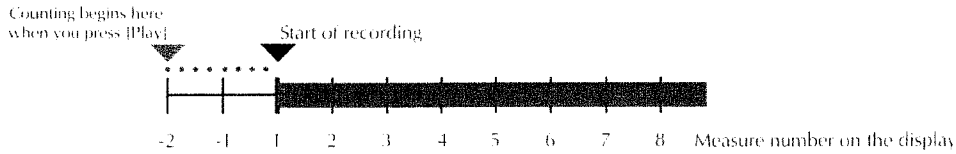

When started at the beginning of the fifth bar

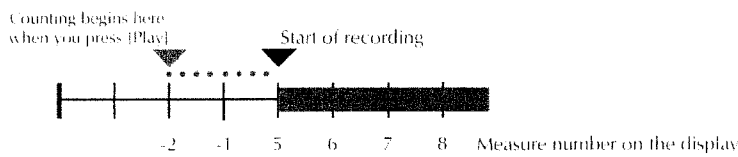

When started in the middle of the fifth bar

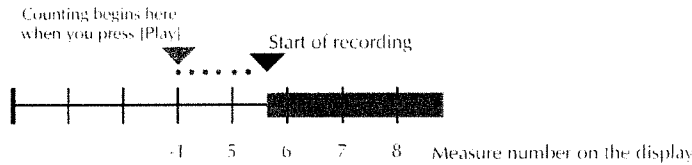

## Recording with Count-In Off

When started at the beginning of the song

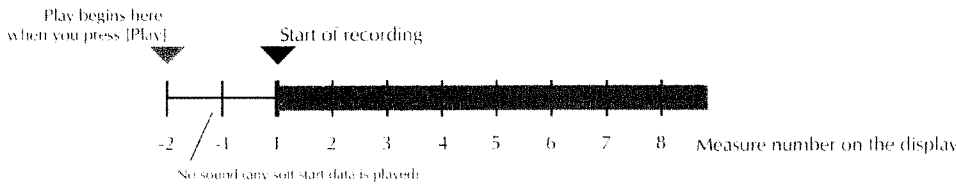

When started at the beginning of the fifth bar

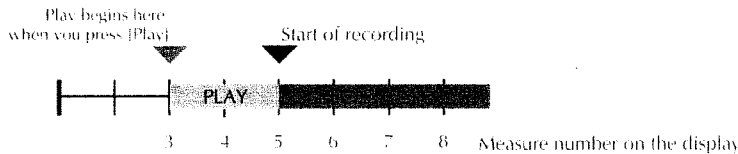

When started in the middle of the fifth bar

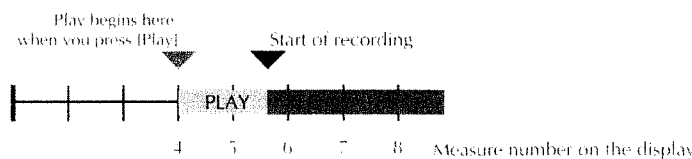



---

## The Different Ways You Can Start A Recording

Record Start Method	The indicator of [Count In]	Standard Recording	Loop Recording (Repeat On)
Press [Play]	Off	Two bars of playing, then recording starts	Recording starts immediately
Press [Play]	On	Two bars of count-in, then recording starts	Two bars of count-in, then recording starts
Play the Keyboard	Off	Recording starts as soon as you play a key on the keyboard	Recording starts as soon as you play a key on the keyboard
Play the Keyboard	On	-	-



No.	Song Name (Display)	Song Title	Date	Note
	. . . . .			
	. . . . .			
	. . . . .			
	. . . . .			
	. . . . .			
	. . . . .			
	. . . . .			
	. . . . .			
	. . . . .			
	. . . . .			
	. . . . .			
	. . . . .			
	. . . . .			
	. . . . .			
	. . . . .			
	. . . . .			
	. . . . .			
	. . . . .			
	. . . . .			
	. . . . .			
	. . . . .			
	. . . . .			
	. . . . .			
	. . . . .			
	. . . . .			
	. . . . .			
	. . . . .			
	. . . . .			
	. . . . .			
	. . . . .			
	. . . . .			
	. . . . .			
	. . . . .			
	. . . . .			
	. . . . .			

# **MT120 Supplement**

This section will quickly explain how to use the MT-120's "Music Minus One" function when you are playing a non-MIDI instrument (acoustic or electric).

# Ensemble Play with a Guitar

Here's how to play your guitar along with the MT-120.

- (1) Connect the MT-120 to your stereo set.  
Connect the guitar to the MT-120.

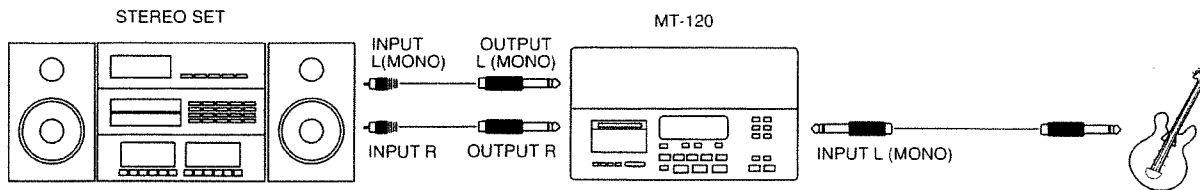

Make sure that the Piano switch on the back of the unit is set to "Int."

- (2) Turn the Input Volume control on the MT-120 all the way counterclockwise, and then set the input selector switch to "Guitar."  
After changing the switch setting, adjust the Input Volume control to the appropriate level.

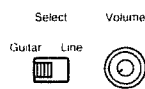

- (3) Insert the disk containing the song you want to play into the disk drive.  
Use the [Value -] and [Value +] buttons to select the song.

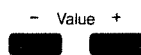

- (4) Press [Play] to start playing the song.



- (5) Press [Minus One].  
This displays the Minus One screen.



\* The Part for which the bar graph display disappears is the Part muted at Sound screen.

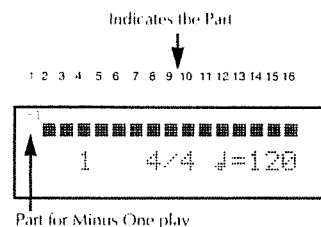

- (6) Use [<] and [>] to move the cursor to the Part you want to play with the guitar.  
Then, let's play your guitar.



Use the Input Volume control on the back of the MT-120 to adjust the input level.

Pressing [Play] again causes only the Minus One Part to be played (solo play).  
Press [Stop] to return to Minus One play.

You can change the tempo using the [Value -] and [Value +] buttons.

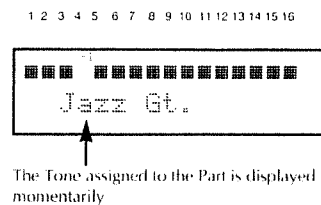

- (7) When you're done playing, press [Stop].



- (8) Press [Minus One] again to cancel Minus One play and return to the Play screen.



\* If you wish to perform tuning, press the [Disk/Tune] button twice and make the desired settings at the Tuning screen.  
Pressing [Play] at the screen shown at right plays an A4 (la) pitch, so tune your guitar to this pitch.

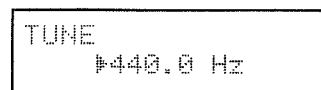

# Ensemble Play with a Keyboard or Electronic Piano

Here's how to play along with the MT-120 on your keyboard or electronic piano.

- Connect the MT-120 to your stereo set.  
Connect the keyboard or the electronic piano to the MT-120.

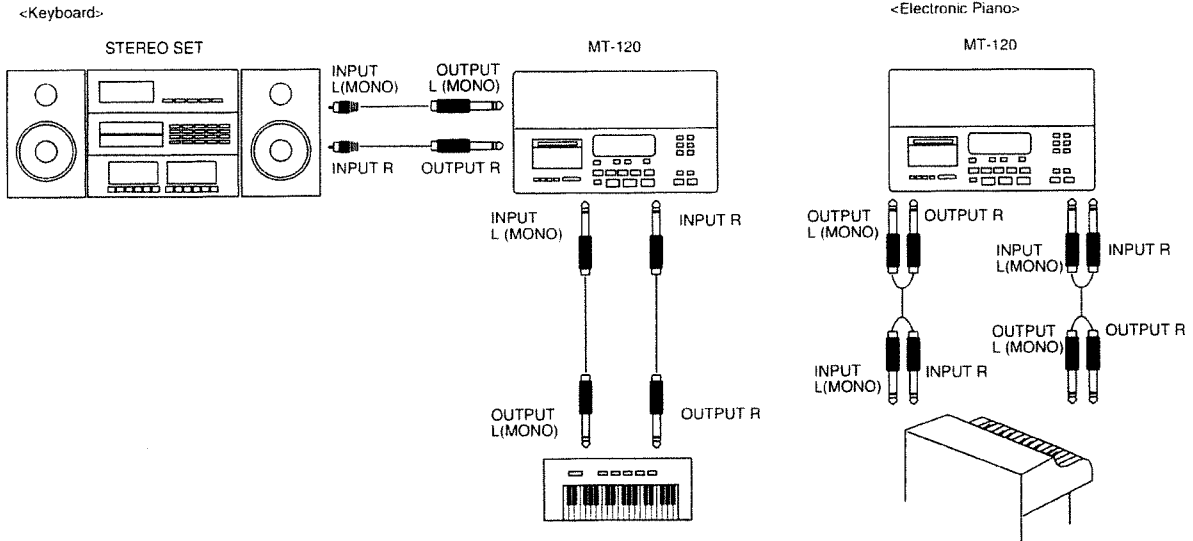

Make sure that the Piano switch on the back of the unit is set to "Int."

- Turn the Input Volume control on the MT-120 all the way counterclockwise, and then set the input selector switch to "Line."  
After changing the switch setting, adjust the Input Volume control to the appropriate level.

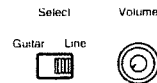

- Insert the disk containing the song you want to play, and use the [Value -] and [Value +] buttons to select the song.

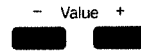

- Press [Play] to start playing the song.



- Press [Minus One]. This displays the Minus One screen.



\* The Part for which the bar graph display disappears is the Part muted at Sound screen.

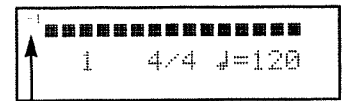
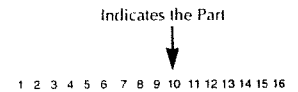

Part for Minus One play

- Use [<] and [>] to move the cursor to the Part you want to play with the keyboard instrument.  
Then, let's play your keyboard or electronic piano.

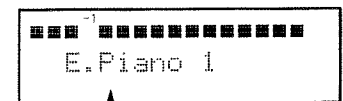
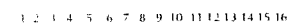

The Tone assigned to the Part is displayed momentarily

To adjust the input level, use the Input Volume control on the back of the MT-120.

Pressing [Play] again causes only the Minus One Part to be played (solo play).  
Press [Stop] to return to Minus One play.

---

You can change the tempo using the [Value -] and [Value +] buttons.

- (7) When you're done playing, press [Stop].



Stop

- (8) Press [Minus One] again to cancel Minus One play and return to the Play screen.

Minus One



# Ensemble Play with an Acoustic Instrument

This section explains how you can play along with the MT-120 with a flute, violin, or other acoustic instrument.

- (1) **Connect the MT-120 to your stereo set.**

Make sure that the Piano switch on the back of the unit is set to "Int."

- (2) **Insert the disk containing the song you want to play into to the disk drive.**  
Use the [Value -] and [Value +] buttons to select the song you want.

- (3) **Press [Play] to start playing the song.**

- (4) **Press [Minus One].**  
This displays the Minus One screen.

\* The Part for which the bar graph display disappears is the Part muted at Sound screen.

- (5) **Use [<] and [>] to move the cursor to the Part you want to play.**  
Then let's play your acoustic instrument.

Pressing [Play] again causes only the muted Part to be played (solo play).  
Press [Stop] to return to Minus One play.

You can change the tempo with the [Value -] and [Value +] buttons.

- (6) **When you're done playing, press [Stop].**

- (7) **Press [Minus One] again to cancel Minus One play and return to the Play screen.**

\* If you wish to perform tuning, press the [Disk/Tune] button twice and make the desired settings at the Tuning screen.  
Pressing [Play] at the screen shown at right plays an A4 (la) pitch, so adjust the pitch.

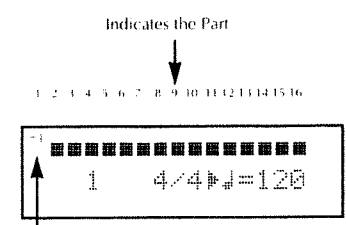
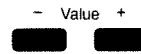
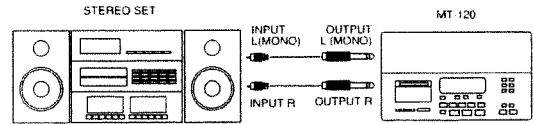

Part for Minus One play

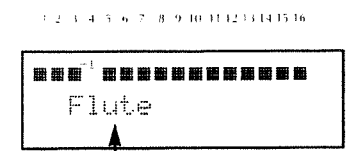

The Tone assigned to the Part is displayed momentarily

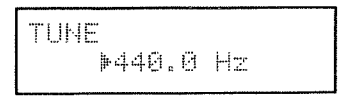

# Adjusting the Volume for a Minus One Part

Minus One play lets you mute out a Part in song data and play that part yourself. You can adjust the volume level of the data for the muted Part on the MT-120.

For instance, if you want to make sure of the pitch of the Part you want to play (the muted part), it might be helpful to make it so that you can just hear the data for the muted part, and then play along with that.

(1) Hold down [Stop] and press [Sound].



(2) Use the [Value -] and [Value +] buttons to select “-1 Part Vol.”

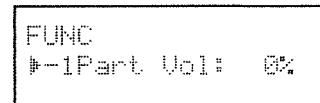
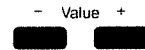

(3) Use [>] to move the “#” cursor, then use the [Value -] and [Value +] buttons to set the Minus One Part volume.

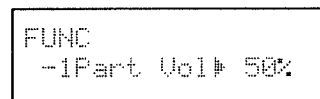

- 0% You can hear what you play and all sounds other than the muted Part (normal Minus One play).
- 50% You can hear what you play and all the other sounds plus the muted Part at 50% of its original volume level.
- 100% You can hear what you play, all the other sounds, plus the muted Part at its original volume level.

- \* This setting is effective only with a Part for Minus One play. If you change the Minus One Part, the new Part takes the volume setting you made in step 3, and the old Part returns to its original volume level.
- \* If you mute some Parts in the Sound screen, you may not be able to hear the Parts other than the one selected for Minus One play. If this happens, go to the Sound screen and turn off Part Muting.
- \* If you use a connected MIDI instrument to play the MT-120's internal sound source and try Minus One play, you should set the volume level to 0%. If the Minus One part volume is at any other setting than 0%, then the volume level of the Part you're playing will change at the same time as the volume level for the muted Part.

(4) Press [Enter].

The MT-120 returns to the Play screen.





# Ensemble Play using the MT-120's Internal Sound Source

If your keyboard is the PC-200 (sold separately) or another keyboard without a sound source, you can use the MT-120's internal sound source for Minus One play.

- (1) Connect the MT-120 to your stereo set.  
Connect the keyboard to the MT-120.

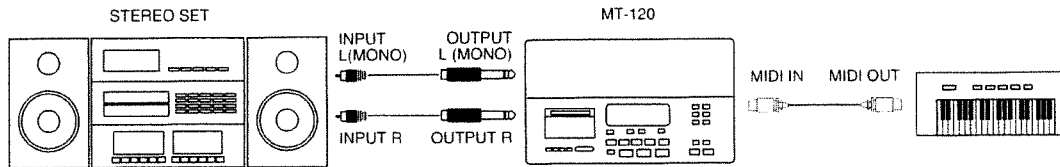

Set the Piano switch on the back of the unit to "Int."  
Also, hold down [Stop] and press [Disk/Tune] to display the MIDI screen, and make sure that the Rx CH Conv switch is set to "On" and the MIDI Out Switch is set to "1CH."

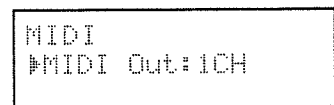
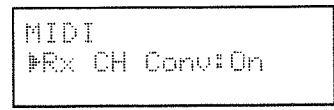

- (2) Insert the disk containing the song you want to play into the disk drive.  
Use the [Value -] and [Value +] buttons to select the song you want.

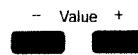

- (3) Press [Play] to start playing the song.



- (4) Press [Minus One].  
This displays the Minus One screen.



\* The Part for which the bar graph display disappears is the Part muted at Sound screen.

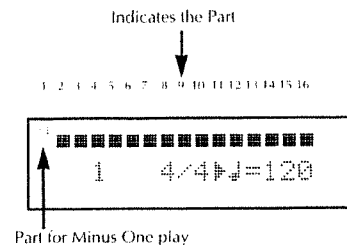

- (5) Use [Left] and [Right] to move the cursor to the Part you want to play.  
Then let's play your keyboard.



Pressing [Play] again causes only the muted Part to be played (solo play).  
Press [Stop] to return to Minus One play.

You can change the tempo with the [Value -] and [Value +] buttons.

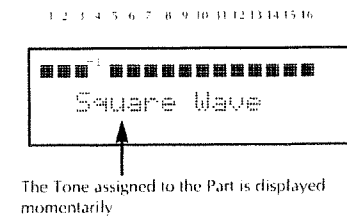

- (6) When you're done playing, press [Stop].



- (7) Press [Minus One] again to cancel Minus One play and return to the Play screen.





For the U.K.

**IMPORTANT:** THE WIRES IN THIS MAINS LEAD ARE COLOURED IN ACCORDANCE WITH THE FOLLOWING CODE.

BLUE : NEUTRAL  
BROWN : LIVE

As the colours of the wires in the mains lead of this apparatus may not correspond with the coloured markings identifying the terminals in your plug, proceed as follows:

The wire which is coloured BLUE must be connected to the terminal which is marked with the letter N or coloured BLACK.  
The wire which is coloured BROWN must be connected to the terminal which is marked with the letter L or coloured RED.

For Nordic Countries

### Apparatus containing Lithium batteries

#### ADVARSEL!

Lithiumbatteri - Eksplosjonsfare ved feilagtig håndtering.  
Udskiftning må kun ske med batteri af samme fabrikat og type.  
Levér det brugte batteri tilbage til leverandøren.

#### VARNING!

Explosionsfara vid felaktigt batteribyte.  
Använd samma batterityp eller en ekvivalent typ som rekommenderas av apparattillverkaren.  
Kassera använt batteri enligt fabrikantens instruktion.

#### ADVARSEL!

Lithiumbatteri - Eksplosjonsfare.  
Ved utskifting benyttes kun batteri som anbefalt av apparatfabrikanten.  
Brukt batteri returneres apparatleverandøren.

#### VAROITUS!

Paristo voi räjähtää, jos se on virheellisesti asennettu.  
Vaihda paristo ainoastaan laitevalmistajan suosittelemaan tyyppiin. Hävitä käytetty paristo valmistajan ohjeiden mukaisesti.

For Germany

### Bescheinigung des Herstellers/Importeurs

Hiermit wird bescheinigt, daß der/die/das

Roland Digital Sequencer And Sound Module MT-120

(Gerät, Typ, Bezeichnung)

in Übereinstimmung mit den Bestimmungen der BMPT-AmtsblVfg 243/1991 funk-entstört ist. Der vorschriftsmäßige Betrieb mancher Geräte (z. B. Meßsender) kann allerdings gewissen Einschränkungen unterliegen. Beachten Sie deshalb die Hinweise in der Bedienungsanleitung.

Dem Zentralamt für Zulassungen im Fernmeldewesen wurde das Inverkehrbringen dieses Gerätes angezeigt und die Berechtigung zur Überprüfung der Serie auf die Einhaltung der Bestimmungen eingeräumt.

Roland Corporation

4-16 Dojimahama 1-Chome Kita-ku Osaka 530 Japan

(Name und Anschrift des Herstellers/Importeurs)

For the USA

### FEDERAL COMMUNICATIONS COMMISSION RADIO FREQUENCY INTERFERENCE STATEMENT

This equipment has been tested and found to comply with the limits for a Class B digital device, pursuant to Part 15 of the FCC Rules. These limits are designed to provide reasonable protection against harmful interference in a residential installation. This equipment generates, uses, and can radiate radio frequency energy and, if not installed and used in accordance with the instructions, may cause harmful interference to radio communications. However, there is no guarantee that interference will not occur in a particular installation. If this equipment does cause harmful interference to radio or television reception, which can be determined by turning the equipment off and on, the user is encouraged to try to correct the interference by one or more of the following measures:

- Reorient or relocate the receiving antenna.
- Increase the separation between the equipment and receiver.
- Connect the equipment into an outlet on a circuit different from that to which the receiver is connected.
- Consult the dealer or an experienced radio/TV technician for help.

Unauthorized changes or modification to this system can void the users authority to operate this equipment.

For Canada

#### CLASS B

#### NOTICE

This digital apparatus does not exceed the Class B limits for radio noise emissions set out in the Radio Interference Regulations of the Canadian Department of Communications.

#### CLASSE B

#### AVIS

Cet appareil numérique ne dépasse pas les limites de la classe B au niveau des émissions de bruits radioélectriques fixés dans le Règlement des signaux parasites par le ministère canadien des Communications.

 Roland®

70123867

UPC

70123867



:099:

 Roland

00128167 '93-9-AG2-11S

MT 120