

Roland®

**Roland**  
Digital Intelligent Piano KF-90



**KF**

## Owner's Manual

Before using this unit, carefully read the sections entitled: "IMPORTANT SAFETY INSTRUCTIONS" (p. 2), "USING THE UNIT SAFELY" (p. 3), and "IMPORTANT NOTES" (p. 5). These sections provide important information concerning the proper operation of the unit. Additionally, in order to feel assured that you have gained a good grasp of every feature provided by your new unit, Owner's Manual should be read in its entirety. The manual should be saved and kept on hand as a convenient reference

Copyright © 2000 ROLAND CORPORATION

All rights reserved. No part of this publication may be reproduced in any form without the written permission of ROLAND CORPORATION.

	<b>CAUTION</b> RISK OF ELECTRIC SHOCK DO NOT OPEN	
<b>ATTENTION:</b> RISQUE DE CHOC ELECTRIQUE NE PAS OUVRIIR		
<b>CAUTION:</b> TO REDUCE THE RISK OF ELECTRIC SHOCK, DO NOT REMOVE COVER (OR BACK). NO USER-SERVICEABLE PARTS INSIDE. REFER SERVICING TO QUALIFIED SERVICE PERSONNEL.		



The lightning flash with arrowhead symbol, within an equilateral triangle, is intended to alert the user to the presence of uninsulated "dangerous voltage" within the product's enclosure that may be of sufficient magnitude to constitute a risk of electric shock to persons.



The exclamation point within an equilateral triangle is intended to alert the user to the presence of important operating and maintenance (servicing) instructions in the literature accompanying the product.

**INSTRUCTIONS PERTAINING TO A RISK OF FIRE, ELECTRIC SHOCK, OR INJURY TO PERSONS.**

## IMPORTANT SAFETY INSTRUCTIONS SAVE THESE INSTRUCTIONS

**WARNING** - When using electric products, basic precautions should always be followed, including the following:

1. Read these instructions.
2. Keep these instructions.
3. Heed all warnings.
4. Follow all instructions.
5. Do not use this apparatus near water.
6. Clean only with a dry cloth.
7. Do not block any of the ventilation openings. Install in accordance with the manufacturers instructions.
8. Do not install near any heat sources such as radiators, heat registers, stoves, or other apparatus (including amplifiers) that produce heat.
9. Do not defeat the safety purpose of the polarized or grounding-type plug. A polarized plug has two blades with one wider than the other. A grounding type plug has two blades and a third grounding prong. The wide blade or the third prong are provided for your safety. When the provided plug does not fit into your outlet, consult an electrician for replacement of the obsolete outlet.
10. Protect the power cord from being walked on or pinched particularly at plugs, convenience receptacles, and the point where they exit from the apparatus.
11. Only use attachments/accessories specified by the manufacturer.
12. Never use with a cart, stand, tripod, bracket, or table except as specified by the manufacturer, or sold with the apparatus. When a cart is used, use caution when moving the cart/apparatus combination to avoid injury from tip-over.
13. Unplug this apparatus during lightning storms or when unused for long periods of time.
14. Refer all servicing to qualified service personnel. Servicing is required when the apparatus has been damaged in any way, such as power-supply cord or plug is damaged, liquid has been spilled or objects have fallen into the apparatus, the apparatus has been exposed to rain or moisture, does not operate normally, or has been dropped.



**For the U.K.**

**WARNING:** THIS APPARATUS MUST BE EARTHED

**IMPORTANT:** THE WIRES IN THIS MAINS LEAD ARE COLOURED IN ACCORDANCE WITH THE FOLLOWING CODE.  
GREEN-AND-YELLOW: EARTH, BLUE: NEUTRAL, BROWN: LIVE

As the colours of the wires in the mains lead of this apparatus may not correspond with the coloured markings identifying the terminals in your plug, proceed as follows:

The wire which is coloured GREEN-AND-YELLOW must be connected to the terminal in the plug which is marked by the letter E or by the safety earth symbol  or coloured GREEN or GREEN-AND-YELLOW.

The wire which is coloured BLUE must be connected to the terminal which is marked with the letter N or coloured BLACK.

The wire which is coloured BROWN must be connected to the terminal which is marked with the letter L or coloured RED.

# USING THE UNIT SAFELY

## INSTRUCTIONS FOR THE PREVENTION OF FIRE, ELECTRIC SHOCK, OR INJURY TO PERSONS

### About ⚠ WARNING and ⚠ CAUTION Notices

<b>⚠ WARNING</b>	Used for instructions intended to alert the user to the risk of death or severe injury should the unit be used improperly.
<b>⚠ CAUTION</b>	Used for instructions intended to alert the user to the risk of injury or material damage should the unit be used improperly. * Material damage refers to damage or other adverse effects caused with respect to the home and all its furnishings, as well to domestic animals or pets.

### About the Symbols

	The ⚠ symbol alerts the user to important instructions or warnings. The specific meaning of the symbol is determined by the design contained within the triangle. In the case of the symbol at left, it is used for general cautions, warnings, or alerts to danger.
	The ⓧ symbol alerts the user to items that must never be carried out (are forbidden). The specific thing that must not be done is indicated by the design contained within the circle. In the case of the symbol at left, it means that the unit must never be disassembled.
	The ● symbol alerts the user to things that must be carried out. The specific thing that must be done is indicated by the design contained within the circle. In the case of the symbol at left, it means that the power-cord plug must be unplugged from the outlet.

## ALWAYS OBSERVE THE FOLLOWING

### ⚠ WARNING

- Before using this unit, make sure to read the instructions below, and the Owner's Manual.

---

- Do not open or perform any internal modifications on the unit.

---

- Do not attempt to repair the unit, or replace parts within it (except when this manual provides specific instructions directing you to do so). Refer all servicing to your retailer, the nearest Roland Service Center, or an authorized Roland distributor, as listed on the "Information" page.

---

- Never use or store the unit in places that are:
  - Subject to temperature extremes (e.g., direct sunlight in an enclosed vehicle, near a heating duct, on top of heat-generating equipment); or are
  - Damp (e.g., baths, washrooms, on wet floors); or are
  - Humid; or are
  - Exposed to rain; or are
  - Dusty; or are
  - Subject to high levels of vibration.

---

- This unit should be used only with a rack or stand that is recommended by Roland.

---

- When using the unit with a rack or stand recommended by Roland, the rack or stand must be carefully placed so it is level and sure to remain stable. If not using a rack or stand, you still need to make sure that any location you choose for placing the unit provides a level surface that will properly support the unit, and keep it from wobbling.

---

- The unit should be connected to a power supply only of the type described in the operating instructions, or as marked on the unit.

### ⚠ WARNING

- Do not excessively twist or bend the power cord, nor place heavy objects on it. Doing so can damage the cord, producing severed elements and short circuits. Damaged cords are fire and shock hazards!

---

- This unit, either alone or in combination with an amplifier and headphones or speakers, may be capable of producing sound levels that could cause permanent hearing loss. Do not operate for a long period of time at a high volume level, or at a level that is uncomfortable. If you experience any hearing loss or ringing in the ears, you should immediately stop using the unit, and consult an audiologist.

---

- Do not allow any objects (e.g., flammable material, coins, pins); or liquids of any kind (water, soft drinks, etc.) to penetrate the unit.

---

- In households with small children, an adult should provide supervision until the child is capable of following all the rules essential for the safe operation of the unit.

---

- Protect the unit from strong impact. (Do not drop it!)

---

- Do not force the unit's power-supply cord to share an outlet with an unreasonable number of other devices. Be especially careful when using extension cords—the total power used by all devices you have connected to the extension cord's outlet must never exceed the power rating (watts/amperes) for the extension cord. Excessive loads can cause the insulation on the cord to heat up and eventually melt through.









---

- Before using the unit in a foreign country, consult with your retailer, the nearest Roland Service Center, or an authorized Roland distributor, as listed on the "Information" page.

## USING THE UNIT SAFELY

---

### CAUTION

- The unit should be located so that its location or position does not interfere with its proper ventilation. 
- Always grasp only the plug on the power-supply cord when plugging into, or unplugging from, an outlet or this unit. 
- Try to prevent cords and cables from becoming entangled. Also, all cords and cables should be placed so they are out of the reach of children. 
- Never climb on top of, nor place heavy objects on the unit. 
- Never handle the power cord or its plugs with wet hands when plugging into, or unplugging from, an outlet or this unit. 
- If you need to move the instrument, take note of the precautions listed below. At least two persons are required to safely lift and move the unit. It should be handled carefully, all the while keeping it level. Make sure to have a firm grip, to protect yourself from injury and the instrument from damage.
  - Check to make sure the knob bolts securing the unit to the stand have not become loose. Fasten them again securely whenever you notice any loosening.
  - Disconnect the power cord.
  - Disconnect all cords coming from external devices.
  - Remove the music stand.
- Before cleaning the unit, turn off the power and unplug the power cord from the outlet (p. 16). 
- Whenever you suspect the possibility of lightning in your area, pull the plug on the power cord out of the outlet. 
- Should you remove the screws fastening the music stand, make sure to put them in a safe place out of children's reach, so there is no chance of them being swallowed accidentally. 

# IMPORTANT NOTES

In addition to the items listed under “IMPORTANT SAFETY INSTRUCTIONS” and “USING THE UNIT SAFELY” on pages 2, 3 and 4, please read and observe the following:

## Power Supply

- Do not use this unit on the same power circuit with any device that will generate line noise (such as an electric motor or variable lighting system).
- Before connecting this unit to other devices, turn off the power to all units. This will help prevent malfunctions and/or damage to speakers or other devices.

## Placement

- Using the unit near power amplifiers (or other equipment containing large power transformers) may induce hum. To alleviate the problem, change the orientation of this unit; or move it farther away from the source of interference.
- This device may interfere with radio and television reception. Do not use this device in the vicinity of such receivers.
- Observe the following when using the unit’s floppy disk drive. For further details, refer to “Before Using Floppy Disks”.
  - Do not place the unit near devices that produce a strong magnetic field (e.g., loudspeakers).
  - Install the unit on a solid, level surface.
  - Do not move the unit or subject it to vibration while the drive is operating.
- Do not expose the unit to direct sunlight, place it near devices that radiate heat, leave it inside an enclosed vehicle, or otherwise subject it to temperature extremes. Also, do not allow lighting devices that normally are used while their light source is very close to the unit (such as a piano light), or powerful spotlights to shine upon the same area of the unit for extended periods of time. Excessive heat can deform or discolor the unit.
- To avoid possible breakdown, do not use the unit in a wet area, such as an area exposed to rain or other moisture.
- Do not allow rubber, vinyl, or similar materials to remain on the piano for long periods of time. Such objects can discolor or otherwise harmfully affect the finish.
- Do not put anything that contains water (e.g., flower vases) on the piano. Also, avoid the use of insecticides, perfumes, alcohol, nail polish, spray cans, etc., near the unit. Swiftly wipe away any liquid that spills on the unit using a dry, soft cloth.

## Maintenance

- To clean the unit, use a dry, soft cloth; or one that is slightly dampened. Try to wipe the entire surface using an equal amount of strength, moving the cloth along with the grain of the wood. Rubbing too hard in the same area can damage the finish.
- Never use benzine, thinners, alcohol or solvents of any kind, to avoid the possibility of discoloration and/or deformation.

## Additional Precautions

- Please be aware that the contents of memory can be irretrievably lost as a result of a malfunction, or the improper operation of the unit. To protect yourself against the risk of losing important data, we recommend that you periodically save a backup copy of important data you have stored in the unit’s memory on a floppy disk
- Unfortunately, it may be impossible to restore the contents of data that was stored on a floppy disk once it has been lost. Roland Corporation assumes no liability concerning such loss of data.
- Use a reasonable amount of care when using the unit’s buttons, sliders, or other controls; and when using its jacks and connectors. Rough handling can lead to malfunctions.
- Never strike or apply strong pressure to the display.
- A small amount of noise may be heard from the display during normal operation.
- When connecting / disconnecting all cables, grasp the connector itself—never pull on the cable. This way you will avoid causing shorts, or damage to the cable’s internal elements.
- A small amount of heat will radiate from the unit during normal operation.
- To avoid disturbing your neighbors, try to keep the unit’s volume at reasonable levels. You may prefer to use headphones, so you do not need to be concerned about those around you (especially when it is late at night).
- When you need to transport the unit, package it in the box (including padding) that it came in, if possible. Otherwise, you will need to use equivalent packaging materials.
- Use only the specified expression pedal (EV-5; sold separately). By connecting any other expression pedals, you risk causing malfunction and/or damage to the unit.
- Do not allow objects to remain on top of the keyboard. This can be the cause of malfunction, such as keys ceasing to produce sound.
- Use a cable from Roland to make the connection. If using some other make of connection cable, please note the following precautions.
  - Some connection cables contain resistors. Do not use cables that incorporate resistors for connecting to this unit. The use of such cables can cause the sound level to be extremely low, or impossible to hear. For information on cable specifications, contact the manufacturer of the cable.

## IMPORTANT NOTES

### Before Using Floppy Disks

#### Handling the Floppy Disk Drive

- Install the unit on a solid, level surface in an area free from vibration. If the unit must be installed at an angle, be sure the installation does not exceed the permissible range.
- Avoid using the unit immediately after it has been moved to a location with a level of humidity that is greatly different than its former location. Rapid changes in the environment can cause condensation to form inside the drive, which will adversely affect the operation of the drive and/or damage floppy disks. When the unit has been moved, allow it to become accustomed to the new environment (allow a few hours) before operating it.
- To insert a disk, push it gently but firmly into the drive—it will click into place. To remove a disk, press the EJECT button firmly. Do not use excessive force to remove a disk which is lodged in the drive.
- Never eject a disk while reading or writing is in progress, since that can damage the magnetic surface of the disk, rendering it unusable. (The disk drive's indicator will light up at full brightness when the drive is busy reading or writing data. Ordinarily, the indicator will be less brightly lighted, or be extinguished.)
- Remove any disk from the drive before powering up or down.
- To prevent damage to the disk drive's heads, always try to hold the floppy disk in a level position (not tilted in any direction) while inserting it into the drive. Push it in firmly, but gently. Never use excessive force.
- To avoid the risk of malfunction and/or damage, insert only floppy disks into the disk drive. Never insert any other type of disk. Avoid getting paper clips, coins, or any other foreign objects inside the drive.

#### Handling Floppy Disks

- Floppy disks contain a plastic disk with a thin coating of magnetic storage medium. Microscopic precision is required to enable storage of large amounts of data on such a small surface area. To preserve their integrity, please observe the following when handling floppy disks:
  - Never touch the magnetic medium inside the disk.
  - Do not use or store floppy disks in dirty or dusty areas.
  - Do not subject floppy disks to temperature extremes (e.g., direct sunlight in an enclosed vehicle). Recommended temperature range: 0 to 50° C (50 to 122° F).
  - Do not expose floppy disks to strong magnetic fields, such as those generated by loudspeakers.

- Floppy disks have a “write protect” tab which can protect the disk from accidental erasure. It is recommended that the tab be kept in the PROTECT position, and moved to the WRITE position only when you wish to write new data onto the disk.

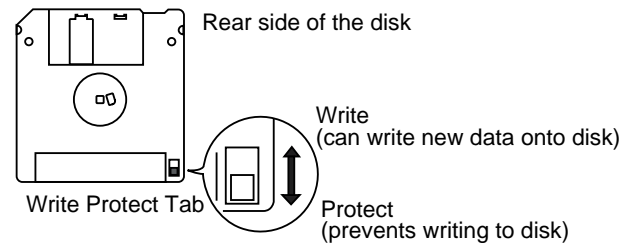

- The identification label should be firmly affixed to the disk. Should the label come loose while the disk is in the drive, it may be difficult to remove the disk.
  - Store all disks in a safe place to avoid damaging them, and to protect them from dust, dirt, and other hazards. By using a dirty or dust-ridden disk, you risk damaging the disk, as well as causing the disk drive to malfunction.
  - Disks containing performance data for this unit should always be locked (have their write protect tab slid to the “Protect” position) before you insert them into the drive on some other unit (except the PR-300, or a product in the HP-G/R, MT, KR, or Atelier families), or into a computer's drive. Otherwise (if the write protect tab remains in the “Write” position), when you perform any disk operations using the other device's disk drive (such as checking the contents of the disk, or loading data), you risk rendering the disk unreadable by this unit's disk drive.
- \* **GS** (GS logo) is a registered trademark of Roland Corporation.
- \* **Apple** is a registered trademark of Apple Computer, Inc.
- \* **Macintosh** is a registered trademark of Apple Computer, Inc.
- \* **IBM** is a registered trademark of International Business Machines Corporation.
- \* **IBM PC** is a registered trademark of International Business Machines Corporation.
- \* **COMPOSER** is a registered trademark of Roland Corporation.
- \* **All product names mentioned in this document are trademarks or registered trademarks of their respective owners.**

# Introduction

Thank you, and congratulations on your choice of the Roland KF-90 Intelligent Piano. While the KF-90 Intelligent Piano certainly allows you to achieve authentic piano performances, it also features easy-to-use Automatic Accompaniment and numerous other useful functions.

In order to enjoy reliable performance of your new keyboard for many years to come, please take the time to read through this manual in its entirety.

## Features

---

### **Authentic Piano Sound**

The KF-90 reproduces the tones of a high-quality grand piano, with stereo sampled sounds that capture the true piano sound so well, you can even hear the hammers hitting the strings. With a maximum polyphony of 64 stereo piano tones, the KF-90 can handle just about any kind of performance, even when extensive pedal work is involved. In addition, the KF-90 features a Progressive Hammer Action, with a heavier touch in the lower keys and lighter touch in the upper keys, for even more realistic piano keyboard feel. All this provides you with more natural, more authentic piano performance.

### **Large Display and Touch Panel**

The KF-90 features a large-sized display screen, and a "Touch Panel" that allows you to perform various tasks merely by touching items displayed on the screen, for easier viewing and more comfortable operation.

### **A Wide Variety of Accompaniment Styles with the Automatic Accompaniment Function**

The KF-90 features numerous music Styles—approximately 140 different Styles are provided—and an Automatic Accompaniment function. You can use these to add the exact accompaniment you have in mind to your own performances.

### **Navigator Buttons Let You Get Straight to What You Want to Accomplish**

There are Navigator buttons for tones, Automatic Accompaniment, and so on. For example, even if you don't understand what a certain button does, you can use the Style Navigator buttons, and just by following the on-screen instructions, make immediate use of the Automatic Accompaniment feature and access many other convenient functions, allowing you to achieve the things you want to do even more easily.

### **Effects Adding Three-Dimensional Breadth to Your Performances (Advanced 3D)**

You can select parts in Performances and add three-dimensional breadth to them. This provides the pleasant effect of "wrapping" your performance within the sound.

### **Convenient Functions to Support Your Practice Efforts (Piano Master)**

Piano Master can be used to greatly simplify a wide variety of operations, such as practicing the same section repeatedly any number of times, and practicing the parts for each hand. You also get useful practice functions, such as a recording feature that works like a regular tape recorder (p. 97), independent playback of each hand's parts (p. 89), a metronome function (p. 63), and more.

### **Expandable Ensemble Opportunities Using MIDI (MIDI Ensemble)**

You can connect this instrument's MIDI connector to an electronic percussion instrument or other separate instrument, allowing you to play ensemble performances. By using "MIDI Ensemble," you can simply connect an instrument to the MIDI connector and start playing using MIDI, without having to be concerned about making a lot of MIDI settings.

### **Make Your Own Authentic Ensemble Songs**

You can use a variety of recording and editing features to compose your own authentic ensemble tunes.

### **Making Use of Commercially Available Music Files for Listening or Lessons**

You can use the built-in disk drive to listen to commercial Music File songs and save recorded tunes on floppy disk (p. 39).

### **Karaoke Enjoyment**

You can connect a microphone and enjoy singing along with songs, just like with a karaoke system (p. 42). You can also add harmony to the microphone vocals, and even change your voice to get robot and other vocal sound effects (p. 43).

### **Refined and Simple Design**

From the tasteful brown tones to real wood used for the sides, this instrument has a look to fit in naturally with your room's interior design.

# Checking the Included Items

---

- Owner's Manual
- Power Cord
- Cover
- Pedal (DP-6) x 1
- Data Disk x 1
- Music Stand

### Screw Set

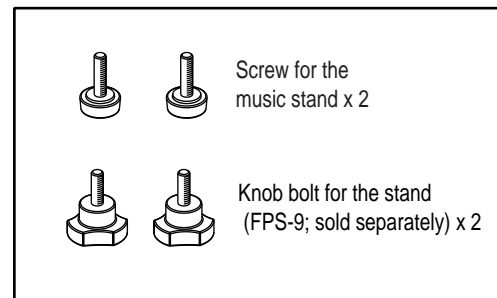

## How to Use This Manual

---

This owner's manual is organized as follows.

### Quick Start

For those just starting out with the KF-90, this volume explains how to make use of the instrument's various performance features simply and easily. We highly recommend reading through the Quick Start manual while you play the instrument, as this will allow you to more fully grasp the kinds of things capable with the KF-90.

### Reference

This section explains the functions available with the KF-90 with easy-to-understand screen shots.

Please refer to the relevant pages for the functions you wish to use.

Refer to the "Contents" when you already know what it is that you want to achieve. If you want to learn how the KF-90's various buttons work, see "Panel Descriptions." Also, be sure to make use of the "Index" at the end of the volume.

### Appendices

If the KF-90 does not operate as you expect, read "Troubleshooting" to make sure that your settings are correct. If an error message appears in the display during operation, consult the "If this Message Appears on Screen" section to determine the appropriate action. The appendices also provide other information, including the Tone list, Style list, MIDI implementation chart, etc.

## ■ Conventions Used in This Manual

- Button names are enclosed in square brackets "[ ]", as in [Demo] button.
- On screen text is enclosed in angled brackets "< >", as in <Exit>.
- The act of lightly contacting the Touch Screen with your finger is called "touching."
- (p. \*\*) refers to pages within the manual.
- An asterisk (\*) or a **NOTE** at the beginning of a paragraph indicates a note or precaution. These should not be ignored.



# Contents

USING THE UNIT SAFELY .....	3
IMPORTANT NOTES .....	5
<b>Introduction .....</b>	<b>7</b>
Features.....	7
Checking the Included Items.....	8
How to Use This Manual.....	8
Conventions Used in This Manual .....	8
<b>Panel Descriptions.....</b>	<b>13</b>
<b>Before You Play .....</b>	<b>16</b>
Installing the Music Stand.....	16
Connecting the Power Cord.....	16
Connecting Pedals.....	16
Turning the Power On and Off .....	17
Adjusting the Sound's Volume and Brilliance.....	17
Connecting Headphones.....	17
Connecting a Microphone.....	18
About the Touch Screen .....	18
Basic Screen.....	19
<b>Quick Start .....</b>	<b>21</b>
<b>Playing the Keyboard .....</b>	<b>22</b>
Listening to the Demo Song.....	22
Playing the Keyboard Like a Piano (One-touch Piano) .....	23
Performing with Various Instrument Sounds.....	24
Handy Features for Selecting Tones ([Tone Navigator] Button).....	25
Practicing a Song Using Music Files (Piano Master).....	26
<b>Playing with Accompaniment .....</b>	<b>28</b>
Playing with Automatic Accompaniment ([Style Navigator] Button) .....	28
Playing with an Automatic Accompaniment (One-touch Arranger) .....	30
<b>Recording a Performance .....</b>	<b>34</b>
Recording a Song ([Composer Navigator] Button) .....	34
Recording a Performance with Automatic Accompaniment.....	36
Listening to the Recorded Performance.....	38
<b>Using Music Files.....</b>	<b>39</b>
Listening to Music Files.....	39
Enjoying Karaoke Performances with Music Files.....	42
Adding the Effects to Your Voice.....	43
<b>Reference .....</b>	<b>49</b>
<b>Chapter 1 Performance.....</b>	<b>50</b>
Playing the Keyboard Like a Piano (One-touch Piano) .....	50
Playing a Wide Variety of Instrument Sounds .....	51
Combining the Sounds of Two Instruments (Layer Play).....	53
Playing Different Tones with the Left and Right Hands (Split Play) .....	55
Selecting a Different Tone in the Current Tone Group .....	56
Shifting the Keyboard Pitch in Octave Steps (Octave Shift) .....	57
Playing Drum Sounds.....	58
Playing Effect Sounds.....	59
Adding Reverberation to Sounds (The Reverb Effect).....	59
Effects Adding Three-Dimensional Breadth to Your Performances (Advanced 3D).....	60

---

Applying Effects to the Sound (Effects) .....	62
Sounding the Metronome.....	63
Changing the Animation.....	63
Adjusting the Tempo.....	64
Determining the Tempo with Tempo Marks .....	64
Changing the Beat of Metronome.....	65
Changing How the Metronome Beat (Pattern) Sounds.....	65
Changing the Type of Sound.....	66
Changing the Volume.....	66
<b>Chapter 2 Using Automatic Accompaniment .....</b>	<b>67</b>
<hr/>	
Music Style and Automatic Accompaniment.....	67
About Chords.....	68
Playing Chords with Simple Fingering .....	68
Displaying the Chord Fingering On Screen (Chord Finder) .....	69
Choosing a Music Style .....	70
Choosing a Music Style from Data Disk .....	71
Playing Sounds with the Left Hand Along with the Automatic Accompaniment.....	72
Playing Just the Rhythm Pattern.....	73
Adjusting the Tempo for Automatic Accompaniment .....	73
Playing a Music Style (Start/Stop).....	74
Starting Automatic Accompaniment When You Play the Left-hand Section (Sync Start). 74	
Starting at the Press of a Button .....	75
Stopping Automatic Accompaniment .....	75
Adjusting the Timing During a Performance and Starting Over.....	75
Playing the Count Sound at the End of the Intro .....	76
Modifying an Accompaniment .....	77
Changing the Accompaniment Pattern Within a Song (Fill-In) .....	77
Changing the Arrangement of the Accompaniment .....	78
Adding Harmony to the Right-hand Part (Melody Intelligence).....	79
Adding Automatic Accompaniment to Regular Piano Performance (Piano Style Arranger) .....	80
Changing the Volume Balance for the Accompaniment and Keyboard .....	81
Adjusting the Volume of Each Performance Part.....	81
<b>Chapter 3 Some Handy Features.....</b>	<b>83</b>
<hr/>	
Playing Back Songs for Practice .....	83
Displaying the Score .....	84
Adjusting the Tempo .....	85
Determining the Tempo Using the Selected Interval.....	86
Playback with No Change in Tempo.....	87
Counting Down Before a Performance Starts .....	88
Preventing the Part to Be Practiced from Sounding.....	89
Placing a Marker Within a Song.....	90
Placing/Erasing a Marker Within a Song .....	90
Playback from a Marker Location.....	91
Moving a Marker.....	91
Playing Back to the Same Passage Over and Over.....	92
Transposing the Key of the Keyboard (Key Transpose).....	93
Transposing a song for playback .....	94
Checking Your Performance On Screen.....	95
Specifying the Part to Display.....	96
<b>Chapter 4 Recording and Saving the Performance .....</b>	<b>97</b>
<hr/>	
Recording Your Playing with Ease .....	98
Recording a Performance Using Automatic Accompaniment .....	100
Redoing a Recording.....	101
Erasing a Recorded Song.....	102
Erasing the Sound Recorded at Specific Track Buttons.....	102
Changing How Recording Stops.....	103

Recording Songs Starting with Pickups .....	104
Composing an Accompaniment By Entering Chords (Chord Sequencer).....	105
Creating a Rhythm Part with Ease.....	108
Saving Songs to Floppy Disks .....	109
Formatting Floppy Disks (Format).....	109
Saving Your Songs on Floppy Disk.....	111
Deleting Songs from Floppy Disks .....	113
Changing the Order of Songs on Floppy Disk.....	114
<b>Chapter 5 Advanced Recording Function .....</b>	<b>115</b>
Selecting the Recording Method .....	115
Recording While Erasing the Previous Recording (Replace Recording) .....	116
Overdubbing Without Erasing the Previous Recording (Mix Recording) .....	116
Repeatedly Recording Over the Same Location (Loop Recording).....	116
Re-Recording Part of Your Performance (Punch-in Recording) .....	117
Multitrack Recording with 16 Parts (16-Track Sequencer).....	118
The 16-track Sequencer Screen.....	119
Recording with the 16 Track Sequencer .....	119
Getting the Most Suitable Part Tones for the Musical Genre (Tone Set) .....	120
Changing the Settings of Each Part.....	120
Composing a Song That Changes the Beat Partway Through.....	122
Changing a Song's Basic Tempo .....	122
Changing the Tempo Within the Song.....	123
Adjusting the Tempo While Listening to a Song.....	123
Adjusting the Tempo at a Particular Measure.....	123
<b>Chapter 6 Editing Functions .....</b>	<b>124</b>
Choosing an Editing Function.....	124
Canceling an Edit.....	124
Copying a Measure .....	125
Copying a Rhythm Pattern .....	126
Correcting Timing Discrepancies.....	126
Deleting a Specific Measure.....	127
Inserting a Blank Measure.....	128
Transposing Individual Parts .....	128
Making a Measure Blank.....	129
Exchanging Parts .....	130
Correcting Notes One by One .....	130
Modifying the Tone Changes in a Song.....	131
<b>Chapter 7 Using Other Functions.....</b>	<b>132</b>
Creating an Original Style (User Style) .....	132
Combining Styles to Create a New Style (Style Composer) .....	132
Creating a Style from a Song You Composed Yourself (Style Converter) .....	134
Saving a User Style.....	137
Saving on the Floppy Disk.....	137
Saving on the [Disk/User] button .....	137
Deleting a User Style Saved on Floppy Disk .....	138
Storing the Panel Settings (User Program) .....	138
Calling Up User Program.....	139
Changing How Button Settings Are Called Up.....	139
Saving User Programs on Floppy Disk .....	140
Calling Up Saved User Programs from Floppy Disk.....	140
Erasing a User Program Saved on a Floppy Disk .....	141
Disabling Everything Except Piano Play (Panel Lock) .....	141
<b>Chapter 8 Changing Various Settings.....</b>	<b>142</b>
Changing the Settings for One Touch Piano .....	142
Adding Ambience from Different Venues to Songs (Ambience).....	142
Changing the Tuning.....	143

Adjusting Resonance .....	144
Changing Key Touch (Key Touch) .....	144
Fine Adjustment of the Piano Tone .....	145
Changing the Settings for Automatic Accompaniment.....	145
Changing the Keyboard's Split Point.....	145
Changing How the Automatic Accompaniment Plays .....	146
Changing the Chord Tone and Bass Tone.....	146
Canceling the Chord Intelligence Function.....	147
Keeping the Same Tone and Tempo When the Music Style Changes.....	147
Assigning Functions to Pedals .....	147
Changing the settings for Score screen .....	149
Changing the Tone Set When Playing Back a Song .....	149
Changing the Settings for the Marker and the Count Sound .....	150
Changing the Number of Measures Counted and the Count Sound.....	150
Playing the Count Sound at Each Repetition.....	150
Placing a Marker in the Middle of a Measure.....	150
Adjusting the Standard Pitch (Master Tuning).....	151
Changing the Type of Reverb Effect.....	151
Changing the Type of Chorus Effect .....	152
Changing the Bend Range.....	152
Changing the Screen Settings .....	153
Hiding the On-screen Lyrics.....	153
Changing the Language .....	153
Adjusting the Contrast of the Screen.....	153
Changing the Screen Message When the Power Is Turned On (Opening Message).....	153
Maintaining Settings After the Power Is Turned Off (Memory Backup).....	154
Restoring the Factory Settings (Factory Reset).....	154
Repositioning the Touch Screen.....	155
<b>Chapter 9 Connecting External Devices .....</b>	<b>156</b>
Connecting MIDI Devices .....	156
MIDI Settings .....	157
Synchronizing with Connected MIDI Devices.....	159
MIDI Ensemble .....	159
Connecting to Audio Equipment .....	160
Connecting a Computer .....	161
<b>Appendices.....</b>	<b>162</b>
<b>Trouble Shooting .....</b>	<b>162</b>
<b>If this Message Appears on Screen .....</b>	<b>164</b>
<b>Tone List.....</b>	<b>166</b>
<b>Drum/SFX Set List.....</b>	<b>170</b>
<b>Music Style List.....</b>	<b>175</b>
<b>Rhythm Pattern List.....</b>	<b>177</b>
<b>Chord List .....</b>	<b>178</b>
<b>Effects List.....</b>	<b>180</b>
<b>Demo Song List.....</b>	<b>181</b>
<b>Data Disk Song List .....</b>	<b>182</b>
<b>Music Files That the KF-90 Can Use .....</b>	<b>183</b>
The KF-90 allows you to use the following music files .....	183
About the KF-90 Sound Generator .....	183
<b>Glossary.....</b>	<b>184</b>
<b>MIDI Implementation Chart .....</b>	<b>186</b>
<b>Main Specifications .....</b>	<b>187</b>
<b>Index.....</b>	<b>189</b>
<b>Important Notes on Combining the KF-90 and FPS-9 .....</b>	<b>193</b>

# Panel Descriptions

## ■ Rear Panel

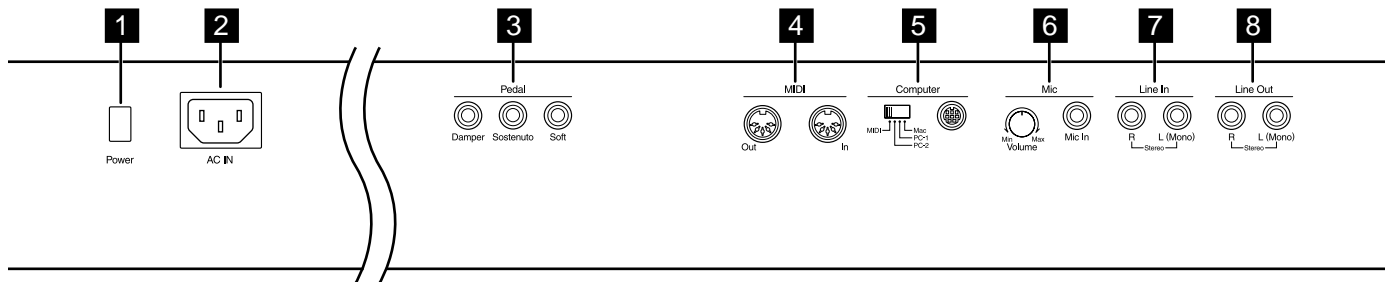

### 1 [Power] Switch

Pressed to switch the power on and off (p. 17).

### 2 AC Inlet

Used only the supplied power cable (p. 16).

### 3 Pedal Jacks

Connect the supplied pedal (DP-6) and others (p. 16).

When connected to Damper, the pedal functions as a damper pedal.

When connected to Sostenuto, the pedal functions as a sostenuto pedal.

When connected to Soft, the pedal functions as a soft pedal.

### 4 MIDI Out/In Connectors

Connect between these and external MIDI instruments to exchange performance information (p. 156).

### 5 Computer

#### Computer Switch

Switches the connections for the MIDI connectors and the computer port (p. 161).

Also, this switch is set to Mac, PC-1, or PC-2 according to the type computer that's connected.

#### Computer Connector

You can connect a computer to this jack to exchange performance information (p. 161).

\* *You can't use the MIDI Out/In connector and the Computer connector at the same time.*

### 6 Mic

#### Volume Knob

Adjusts the volume level for the microphone (p. 18).

#### Mic In Jack

Used for connecting microphones (p. 18).

### 7 Line In Jacks

You can connect audio equipment or other digital instruments and hear them through the KF-90's speakers (p. 160).

### 8 Line Out Jacks

You can use these to play the notes from the KF-90 on an audio device or record what you play on a tape recorder (p. 160).

## ■ Front Panel

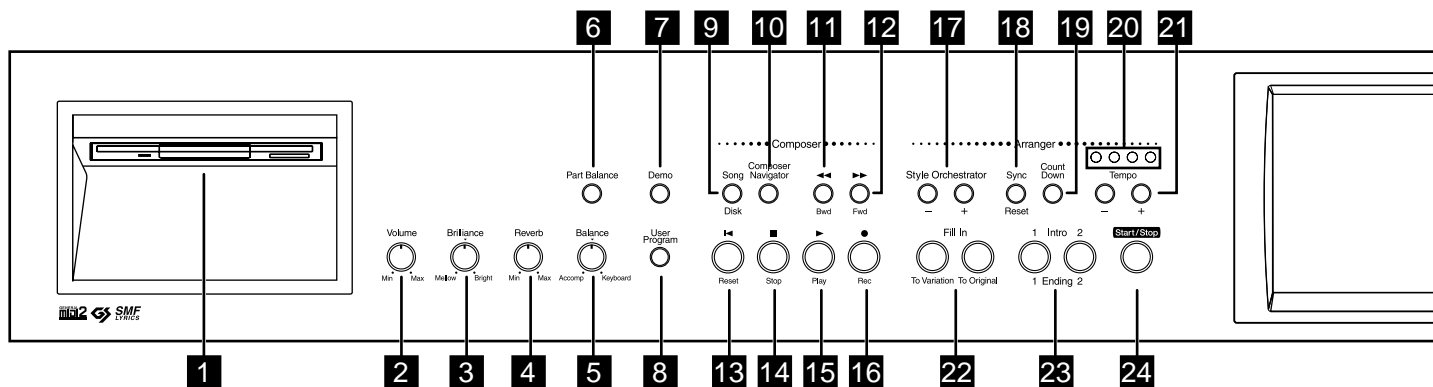

### 1 Disk Drive

You can insert a floppy disk for playing back or saving songs (p. 39, p. 109).

### 2 [Volume] Knob

Adjusts the overall volume level (p. 17).

### 3 [Brilliance] Knob

Adjusts the tone brightness (p. 17).

### 4 [Reverb] Knob

Adjusts the amount of reverb (p. 59).

### 5 [Balance] Knob

Changes the volume balance for sounds played with the keyboard and for songs and accompaniments (p. 81).

### 6 [Part Balance] Button

Use this button to adjust the relative volumes of each of the parts played in the Automatic Accompaniment, the percussion or effects sounds played with the keyboard, and the tones played with the keys (p. 81).

### 7 [Demo] Button

Press this to hear an internal demo song and to view the KF-90's main features in the display (p. 22).

### 8 [User Program] Button

Stores the selected functions and states of the buttons. It can also call up settings that have been stored (p. 138).

## Composer Section

### 9 [Song/Disk] Button

This can be used to make settings for the disk, such as saving a recorded song on floppy disk (p. 39, p. 83, p. 109).

### 10 [Composer Navigator] Button

You can select convenient functions for playing back, recording or editing a song (p. 34).

### 11 Bwd [◀◀] Button

Rewinds the song.

### 12 Fwd [▶▶] Button

Fast-forwards the song.

### 13 Reset [◀] Button

Sets the position from which playback will begin to the start of the song.

### 14 Stop [■] Button

Pressed to stop playback or recording.

### 15 Play [▶] Button

Starts playback or recording for a song.

### 16 Rec [●] Button

Puts the keyboard in record standby mode.

## Arranger Section

### 17 Style Orchestrator [-] [+] Buttons

Used to change the arrangement type for automatic accompaniment (p. 78).

### 18 [Sync/Reset] Button

This setting simultaneously starts the Automatic Accompaniment when any key in the left side of the keyboard is played (p. 74). Additionally, by pressing this button while Automatic Accompaniment is being played, you can restart with the accompaniment synchronized (p. 75).

### 19 [Count Down] Button

Lets you know the end of intro with counts down (p. 76).

### 20 Beat Indicator

This lights up in correspondence with the beat of the selected song or accompaniment.

### 21 Tempo [-] [+] Buttons

Adjust the tempo (p. 64, p. 73, p. 85).

Press the [-] and [+] buttons at the same time to return to the basic tempo.

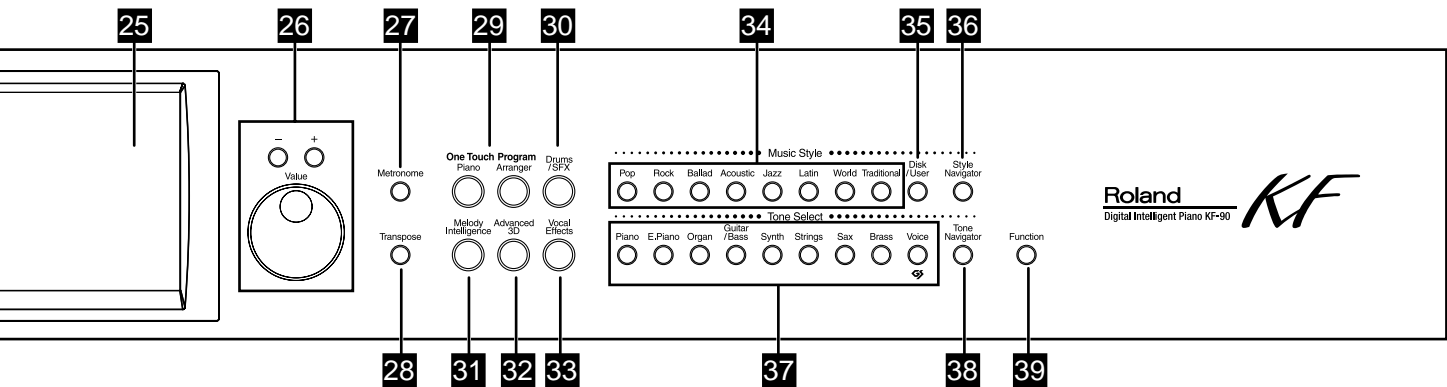

## 22 Fill In

### [To Variation] Button

Inserts a fill-in in an automatic accompaniment and changes to the Variation accompaniment pattern (p. 77).

### [To Original] Button

Inserts a fill-in in an automatic accompaniment and changes to the Original accompaniment pattern (p. 77).

## 23 Intro/Ending [1] [2] Buttons

Play an intro or ending during automatic accompaniment (p. 74).

## 24 [Start/Stop] Button

Starts and stops automatic accompaniment (p. 75).

## 25 Touch Screen

This lets you perform a variety of operations just by touching the screen (p. 18).

## 26 Value [-] [+] Buttons / Dial

You can use this to change on-screen values or select various items.

## 27 [Metronome] Button

Activates the built-in metronome. And you can change the metronome settings (p. 63).

## 28 [Transpose] Button

Transposes the keyboard or songs pitch (p. 93).

## 29 One Touch Program

### [Piano] Button

Changes the keyboard to a piano sound and makes the optimal settings for a piano performance (p. 23, p. 50).

### [Arranger] Button

Makes the optimal settings for playing with automatic accompaniment (p. 30, p. 70).

## 30 [Drums/SFX] Button

Changes the keyboard to play percussion and effect sounds (p. 58).

## 31 [Melody Intelligence] Button

Adds harmony to the sounds played with the keyboard (p. 79).

## 32 [Advanced 3D] Button

When performing along with the automatic accompaniment or the internal songs, you can add three-dimensional breadth (p. 60).

## 33 [Vocal Effect] Button

Applies a variety of effects to vocals from the microphone (p. 43).

## Music Style Section

### 34 Music Style Buttons

Selects a internal Music Style (p. 30, p. 70).

### 35 [User/Disk] Button

Selects a Style on the floppy disk (p. 71), or to choose a User Style that you've made yourself (p. 132).

### 36 [Style Navigator] Button

Press this button to select convenient functions when performing with Automatic Accompaniment or when creating Styles (p. 28).

## Tone Select Section

### 37 Tone Select Buttons

Selects the kinds of sounds (Tone groups) played by the keyboard (p. 24, p. 51).

### 38 [Tone Navigator] Button

You can select convenient functions for selecting tones (p. 25).

### 39 [Function] Button

Selects a variety of play-related functions (p. 26, p. 151-p. 155).

# Before You Play

## Installing the Music Stand

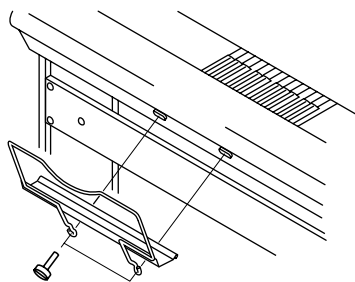

**1. Using the supplied screws, fasten the music stand to the back of the KF-90 as illustrated.**

Turn the screws clockwise to tighten them.

**2. To remove the music stand, support it with one hand while loosening the screws.**

- \* Be sure to use the supplied screws for attaching the music stand.
- \* When attaching the music stand, support it firmly with one hand to make sure that you do not drop it. Be careful, so you do not get your fingers pinched.
- \* Do not apply excessive force to the installed music stand.

## Connecting the Power Cord

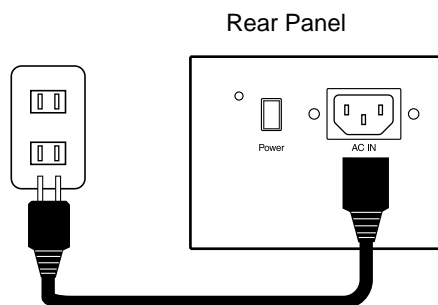

- \* Be sure to use the supplied power cord.

- 1. Connect the supplied power cord to the AC inlet on the back of the piano.**
- 2. Plug the power cord into an AC outlet.**

## Connecting Pedals

- 1. Connect the supplied pedals (DP-6) to one of the pedal jacks.**

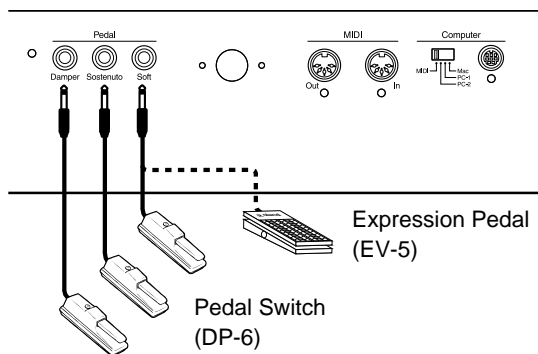

When connected to the Damper jack, the pedal can be used as a damper pedal.

When connected to Sostenuto, the pedal can be used as a sostenuto pedal.

When connected to Soft, the pedal can be used as a soft pedal.

- \* *Unplugging a pedal cord from the unit while the power is on may cause the pedal's effect to be applied without stopping. Be sure to switch off the power to the unit before attempting to disconnect or connect a pedal cord.*

### Damper Pedal

Use this pedal to sustain the sound.

While the pedal is depressed, long lingering reverberations continue to be added to the sound after you release from the keys. When you depress the damper pedal on an acoustic piano, the sound from the strings that were struck resonates with other strings, adding rich reverberations and broadness to the sound. You can adjust this resonance (Sympathetic Resonance) when the damper pedal is depressed.

- *You can vary the amount of resonance applied when the damper pedal is depressed. Refer to "Adjusting Resonance" (p. 144).*

### Sostenuto Pedal

When this pedal is depressed, reverberations are applied only to the keys being played at that time.

### Soft Pedal

This pedal is used to make the sound softer.

Playing with the soft pedal depressed produces a sound that is not as strong as when otherwise played with the equivalent strength. This is the same function as the left pedal of an acoustic piano.

- *When connected to the Sostenuto jack or the Soft jack, you can also assign other functions to the connected pedal. For more information, see "Assigning Functions to Pedals" (p. 147).*
- *By providing two more pedals, you can use three pedals at the same time. If you wish to purchase the optional pedal (DP-2/DP-6), please contact the dealer where you purchased the keyboard.*
- *You'll be able to change the pitch smoothly using the "Glide" and "Bend Up/Down" functions (p. 147), after you connect an EV-5 Expression Pedal (sold separately) to the Sostenuto or Soft jack. An expression pedal can't be used to adjust the volume, however.*



## Turning the Power On and Off

Be sure to follow the steps below when turning the power on or off. By turning on devices in the wrong order, you risk causing malfunction and/or damage to speakers and other devices.

### Turning On the Power

1. Before you switch on the power, turn the volume down all the way by rotating the [Volume] knob.

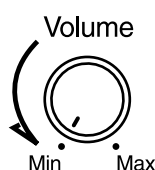

2. Press the [Power] switch on the back of the unit.

After a few seconds, the unit becomes operable and playing the keyboard produces sound. Adjust the volume at appropriate levels.

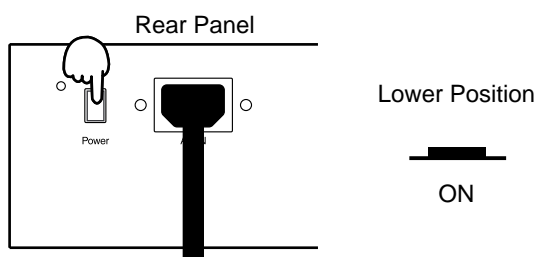

\* This unit is equipped with a protection circuit. A brief interval (a few seconds) after power up is required before the unit will operate normally.

### Turning Off the Power

1. Before switching the power off, turn the volume all the way down by rotating the [Volume] knob.
2. Press the [Power] switch on the back of the unit. The power is switched off.

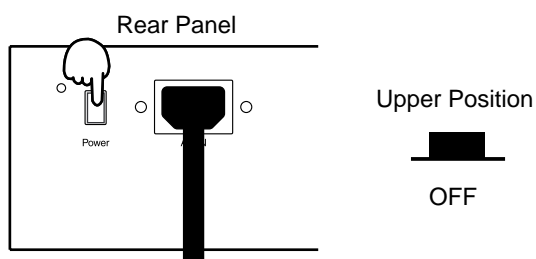

## Adjusting the Sound's Volume and Brilliance

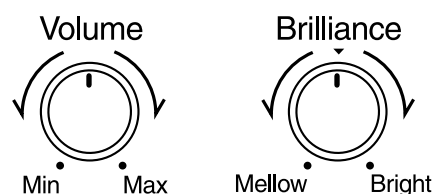

Use the [Volume] knob to adjust the overall volume level.

Rotating the knob toward the right increases the volume; rotating it toward the left decreases the volume.

3. Use the [Brilliance] knob to adjust the overall sound quality.

Rotating the knob clockwise makes the tone brighter; rotating it counterclockwise makes the sound more restrained.

## Connecting Headphones

The unit's speakers will go silent when you plug in headphones. This makes it convenient for playing at night, or at other times when you do not want to disturb others.

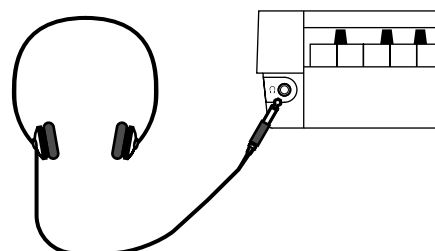

1. Plug the headphones into the Phones jack at the front, on the left side of the piano.

The sound from the built-in speakers stops. Now, sound is heard only through the headphones.

2. Use the [Volume] knob on the KF-90 to adjust the volume of the headphones.

→ Use Stereo headphones.

### Some Notes on Using Headphones

- To prevent damage to the cord, handle the headphones only by the headset or the plug.
- The headphones may be damaged if the volume is too high when they are plugged in. Lower the volume on the KF-90 before plugging in the headphones.
- To prevent possible auditory damage, loss of hearing, or damage to the headphones, the headphones should not be used at an excessively high volume. Use the headphones at a moderate volume level.

## Connecting a Microphone

You can connect a microphone into the Mic In jack, and enjoy karaoke with the KF-90.

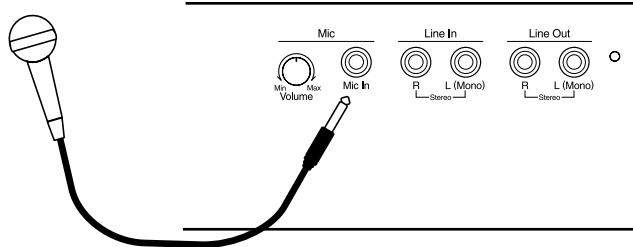

1. Connect a microphone to the Mic In jack on the back of the instrument.
2. Rotate the [Mic Volume] knob next to the Mic In jack to adjust the volume level for the microphone.

→ You can use a microphone (sold separately). When purchasing a microphone, please consult the vendor where you bought the KF-90.

### Some Notes on Using a Microphone

- Be careful of high volume levels when using mikes late at night or early in the morning.
- When connecting a microphone to the KF-90, be sure to lower the volume. If the volume control is too high when the microphone is plugged in, noise may be produced by the speakers.
- Howling could be produced depending on the location of microphones relative to speakers. This can be remedied by:
  - Changing the orientation of the microphone.
  - Relocating microphone at a greater distance from speakers.
  - Lowering volume levels.

## About the Touch Screen

The KF-90 makes use of a Touch Screen. This lets you carry out a wide variety of actions just by touching the screen.

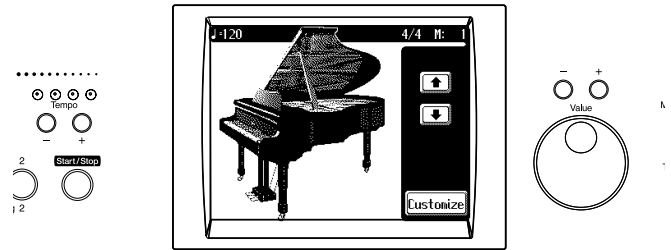

Immediately after the power is turned on, this screen appears. For more detailed information, refer to p. 50.

- \* The Touch Screen is operated by touching it with your finger. Pressing hard, or using a hard object can damage the Touch Screen. Be careful not to press too hard, and be sure to use only your fingers to operate the Touch Screen.
- \* The positioning of the Touch Screen may become displaced due to changes in the surrounding environment and over time. If this happens, follow the steps in "Repositioning the Touch Screen" (p. 155) to correct the pointer position.
- \* Do not place items on the touch panel.

## ■ Basic Screen

The following screen is called “Basic Screen.”

You can usually display this screen by touching <Exit> in the display several times.

If touching <Exit> doesn't display this screen, follow either of the procedures described below to display it.

- Press the One Touch Program [Arranger] button.  
The basic screen appears and displays the settings for Automatic Accompaniment.
- Hold down the One Touch Program [Piano] button and press any one of the Tone Select buttons, then touch <Exit>.

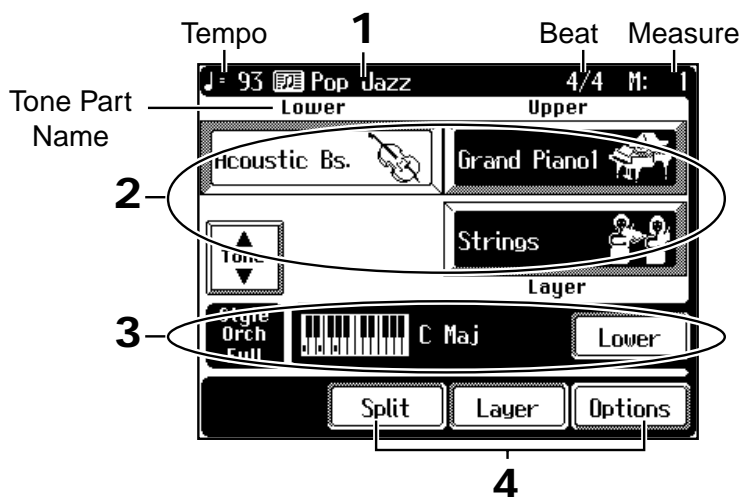

1	Such as the name of the song and Music Style appears.
2	The Tone names are selected appear.
3	Information about the Automatic Accompaniment, such as the form of each of the chords as they are played and icons are shown in the display. Information about the manner in which the chords are played is not displayed when Automatic Accompaniment is not being used.
4	The on-screen graphics that appear three dimensional work like buttons. These are called “Icons.”

### Using the Main Icons

With the KF-90, you can many other screens besides the basic screen to do things. The main icons you can use on these screens are as follows.

	Some screens consist on two or more pages. You can display the next page or the previous page of the screen by touching Page < ◀ > or < ▶ >.
	Touch this to exit the screen that is currently displayed. You can usually display the Basic screen by touching <Exit> several times.

- \* You can adjust the contrast of the screen. Check out “Adjusting the Contrast of the Screen” (p. 153).
- \* The explanations in this manual include illustrations that depict what should typically be shown by the display. Note, however, that your unit may incorporate a newer, enhanced version of the system (e.g., includes newer sounds), so what you actually see in the display may not always match what appears in the manual.

# MEMO

---

**Roland**

Digital Intelligent Piano KF-90

**KF**

***Quick Start***

# Playing the Keyboard

## Listening to the Demo Song

You can watch the introductions of KF-90's sound and keyboard, or listen to the demo songs, which use a variety of the KF-90's built-in instrument sounds and Music Styles (accompaniment styles in various musical genres).

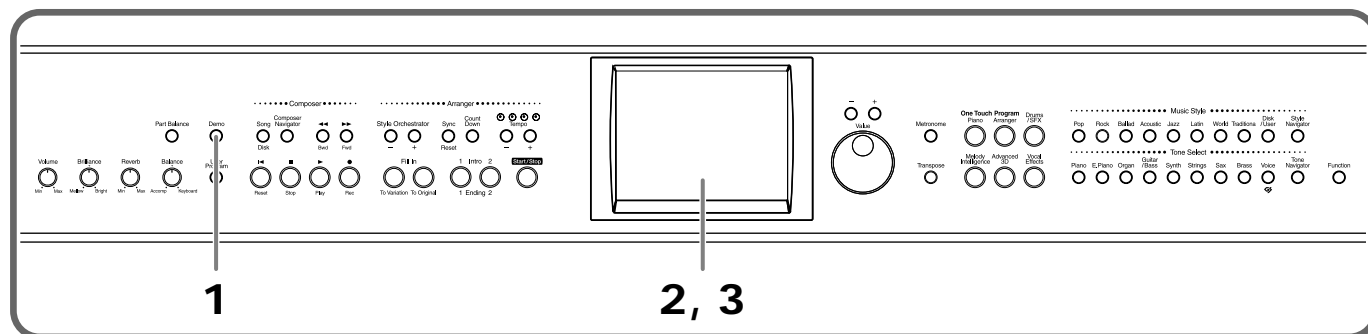

### 1. Press the [Demo] button.

A Demo screen appears.

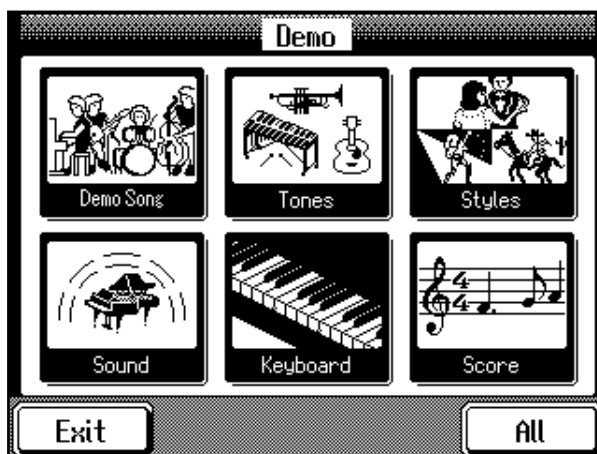

### 2. Touch the screen to select the demo type.

Display	Content
<b>Demo Songs</b>	Demo song performance
<b>Tones</b>	Demo performance of the internal tones
<b>Styles</b>	Demo performance of the internal Music Styles
<b>Sound</b>	Description of the KF-90 piano tones
<b>Keyboard</b>	Description of the KF-90 Keyboard (Progressive Hammer Action)
<b>Score</b>	Description of the scores that can be displayed on the KF-90

By touching <All>, you can view these demos in succession.

Touch <Exit> to go back to the Demo screen.

### 3. Touch <Exit> at the bottom left of the screen to end the Demo screen.

# Playing the Keyboard Like a Piano (One-touch Piano)

First, let's try piano play.

By pressing the One Touch Program [Piano] button you can instantly make the optimal settings for piano performances.

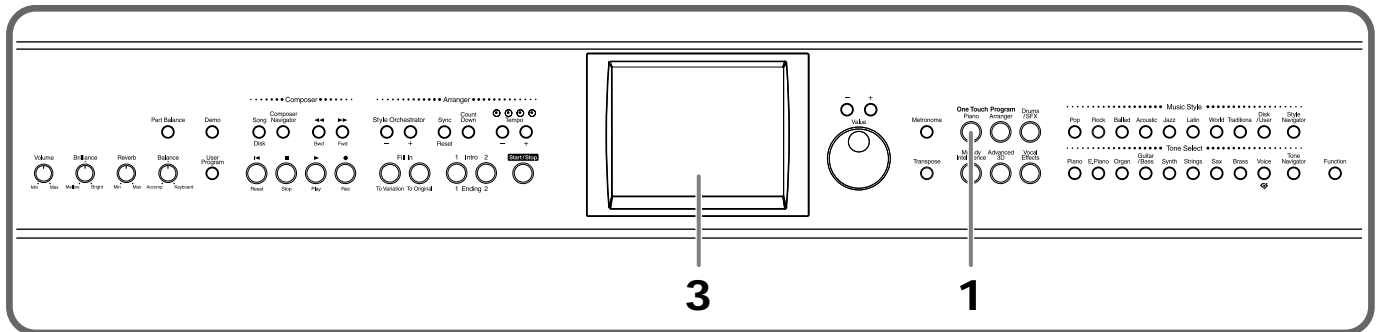

## 1. Press the One Touch Program [Piano] button.

A Piano screen like the one shown below appears.

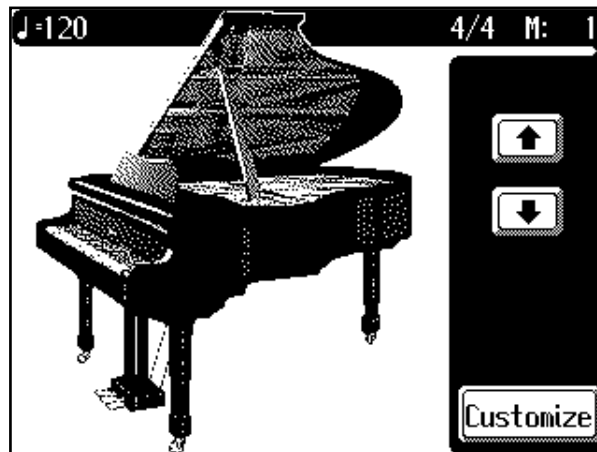

## 2. When you finger the keyboard, the piano sound is produced.

In this way, you can make the settings for piano play at any time using the One Touch Program [Piano] button.

## 3. Touch or next to the picture of the piano, then finger the keyboard.

The amount by which the piano's top is opened changes, and the sound also changes.

## Performing with Various Instrument Sounds

The KF-90 is able to produce the sounds of various instruments and effects. The various types of sounds are called “Tones.”

The tones are divided into nine separate groups, each assigned to the Tone Select buttons.

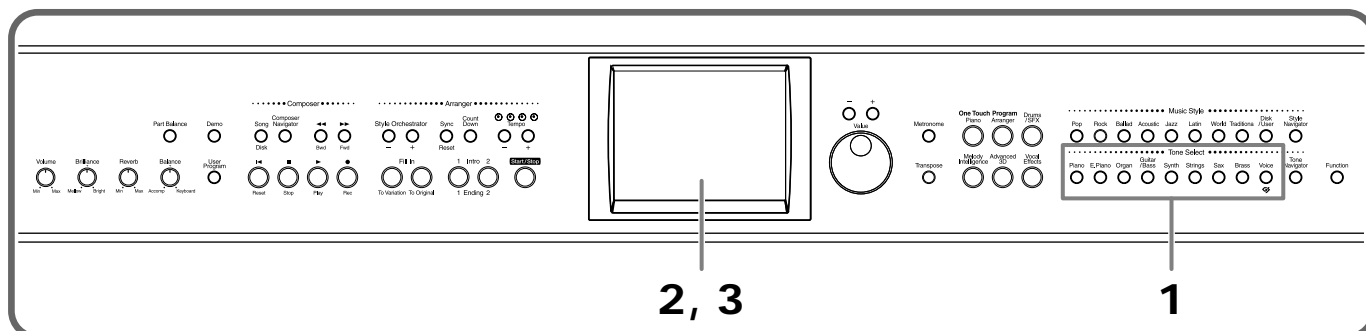

### 1. Press one of the Tone Select buttons to choose a Tone Group.

The screen shows six of the Tones included in the chosen Tone Group.



### 2. Touch Page < <> <> > to switch screens.

The screen changes, and other tones in the selected tone group are displayed. Choose the tone you want to play.

### 3. Touch the screen to choose the tone you want to select.

You can listen to a typical phrase for the Tone by touching <Audition> at the bottom right of the screen.

When you play the keyboard, the selected tone is played.

Touch <Exit> to go back to the Basic screen (p. 19).

Try choosing and playing a variety of different tones.

### About “EX” Tone

These are tones that Roland recommends you use in order to enjoy enhanced expressive capabilities.

Some of the EX Tones change according to the force with which the keys are played (velocity).



# Handy Features for Selecting Tones ([Tone Navigator] Button)

Pressing the [Tone Navigator] button lets you use a handy feature when selecting tones.

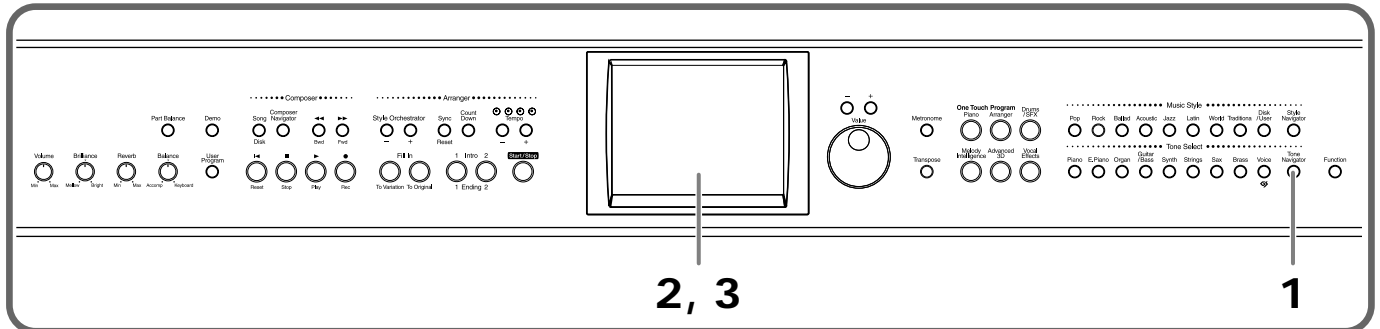

## 1. Press the [Tone Navigator] button.

A Tone Navigator screen like the one below appears.

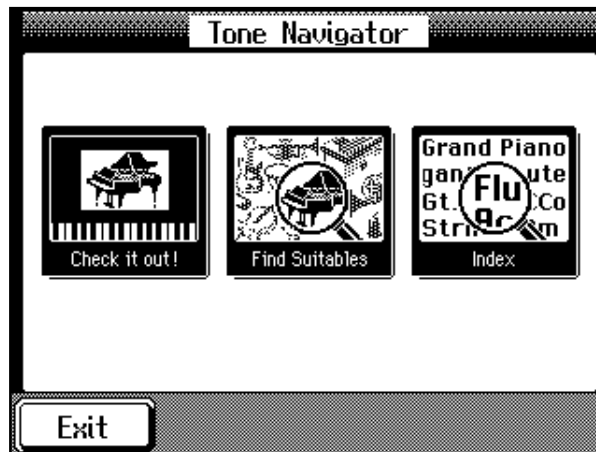

## 2. Touch the screen to choose the desired activity.

Display	Description
<b>Check It Out!</b>	You can select tones just by touching icons for the suggested tones, or combination of tones, displayed on the screen.
<b>Find Suitable</b>	After selecting the type of musical instrument and musical genre, you can then find tones that will sound good with your selections.
<b>Index</b>	Allows searching of tones using the first letter of the tone name.

Touch <Exit> to go back to the Tone Navigator screen.

## 3. Touch <Exit> at the bottom left of the screen to end the Tone Navigator screen.

## Practicing a Song Using Music Files (Piano Master)

Now, let's have some fun practicing using the song data on the Data Disk included with the KF-90.

"Piano Master" can help you master your favorite songs.

You can practice using commercially available Music Files, not just the included disk.



About Music Files, take a look at "Music Files That the KF-90 Can Use" (p. 183).

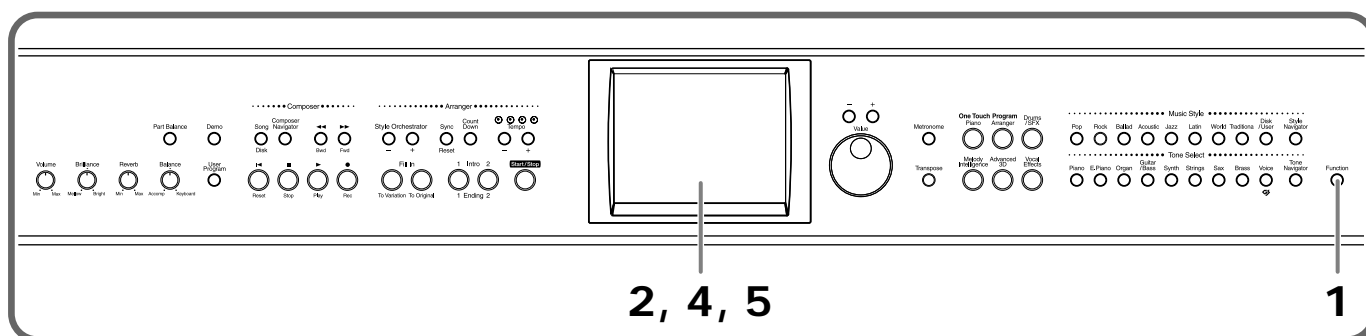

### 1. Press the [Function] button.

A Function screen like the one below appears.

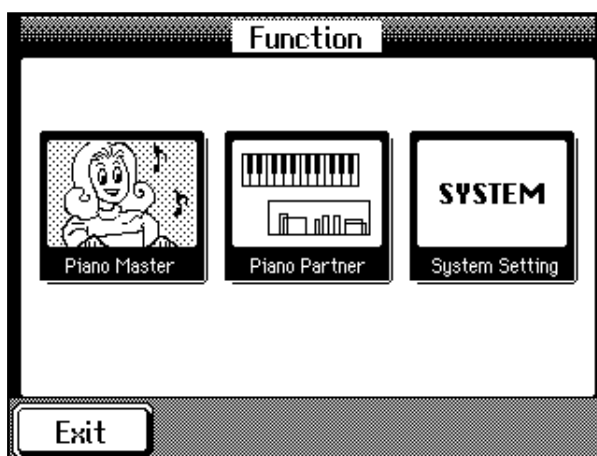

2. Touch <Piano Master> on the Touch Screen.
3. Insert a floppy disk containing a song for practice into the disk drive.
4. Follow the on-screen instructions to practice.
5. Touch <Exit> at the bottom left of the screen to end the Piano Master.

The Function screen appears.

---

# MEMO

---

# Playing with Accompaniment

## Playing with Automatic Accompaniment ([Style Navigator] Button)

Pressing the [Style Navigator] button lets you use a feature that makes play with automatic accompaniment even more enjoyable.

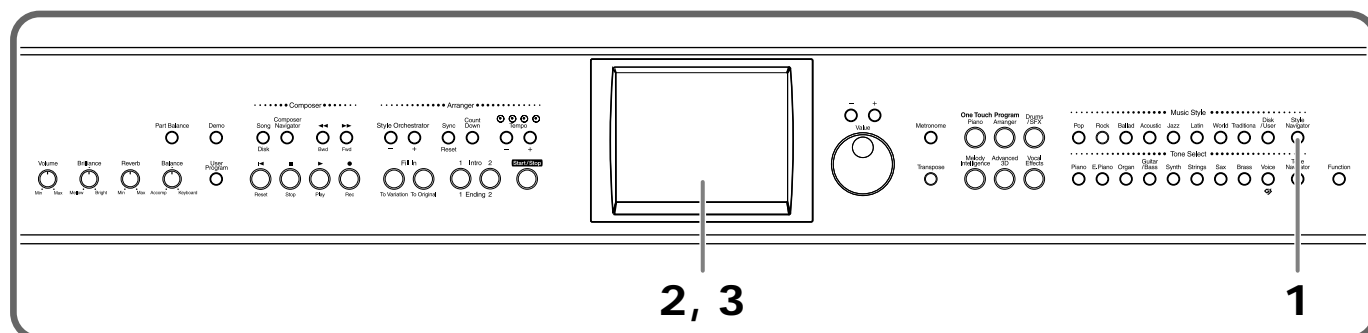

### 1. Press the [Style Navigator] button.

A Style Navigator screen like the one below appears.

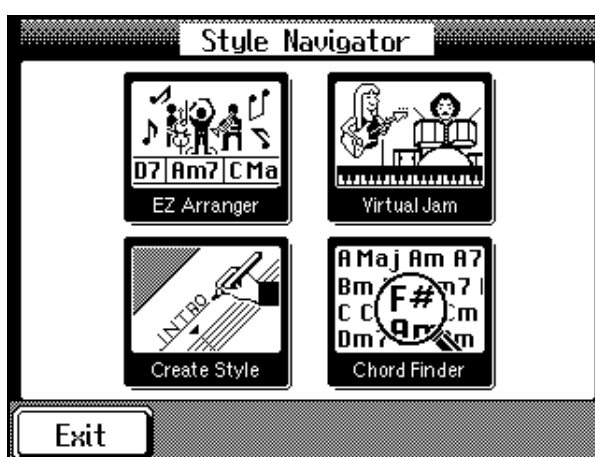

### 2. Touch the screen to choose the desired activity.

Display	Description
<b>EZ Arranger</b>	Take a look at page 29.
<b>Virtual Jam</b>	Take a look at page 29.
<b>Create Style</b>	You can Create a original style (User Style) by using the method of Style Composer and Style Converter (p. 132).
<b>Chord Finder</b>	You can have the notes comprising the chord be shown in the screen, whenever you are not sure how a certain chord is fingered (p. 69).

Touch <Exit> to go back to the Style Navigator screen.

### 3. Touch <Exit> at the bottom left of the screen to end the Style Navigator screen.

## ■ Enjoying Automatic Accompaniment with Ease (EZ Arranger)

Let's try playing using Automatic Accompaniment.

Automatic Accompaniment is a feature that creates an accompaniment matched to the chords you specify with the left hand, making the performance more impressive and enjoyable.

To use Automatic Accompaniment, you need to press some buttons and make the settings for Automatic Accompaniment, but EZ Arranger lets you use Automatic Accompaniment just by answering some onscreen questions.

### 1. Press the [Style Navigator] button.

The Style Navigator screen appears.

### 2. Touch <EZ Arranger>.

### 3. Follow the onscreen instructions.

When you've answered all the questions, you can start playing with Automatic Accompaniment right away.

When specifying the chords yourself in a performance, specify the chords in the left part of the keyboard, as illustrated below.

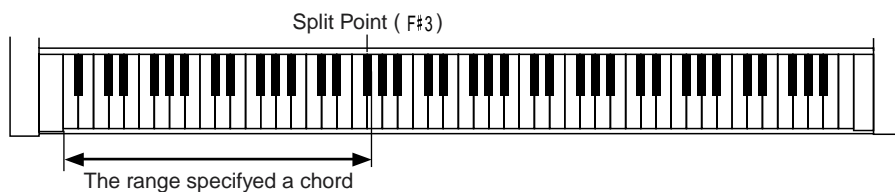

### 4. Touch <Exit> to end the EZ Arranger.

The Style Navigator screen appears.

## ■ Playing with your band (Virtual Jam)

You can select the Pattern to be performed in each Part, and have these played together just like a backing band. Furthermore, you have complete freedom in combining the Parts.

### 1. Press the [Style Navigator] button.

The Style Navigator screen appears.

### 2. Touch <Virtual Jam>.

### 3. Follow the onscreen instructions.

When you've answered all the questions, you can start playing with Automatic Accompaniment right away.

### 4. Touch <Exit> to end the Virtual Jam.

The Style Navigator screen appears.

## Playing with an Automatic Accompaniment (One-touch Arranger)

In this section we will explain how you use Automatic Accompaniment not using [Style Navigator].

When using Automatic Accompaniment, press the One Touch Program [Arranger] button. You can make the optimal settings for playing Automatic Accompaniment with just a single touch of this button.

### ■ Let's Try Playing, "Little Brown Jug"

Now, let's try playing "Little Brown Jug" (you can see the score on page 32) using Automatic Accompaniment.

In this example we'll play the song with the "Big Band" Music Style.

You can enjoy a different ambience even with the same song just by changing the Music Style. Let's try playing with a wide variety of Music Styles.

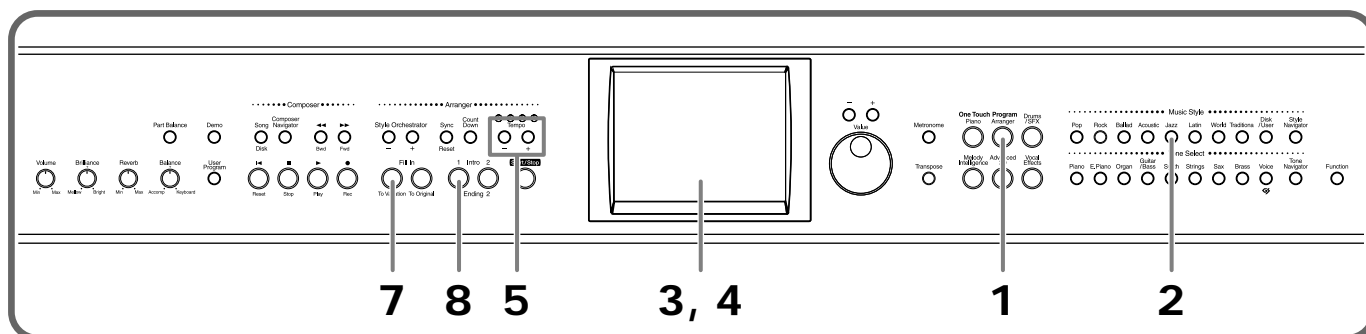

#### 1. Press the One Touch Program [Arranger] button.

The following screen like the one below, is called "Basic Screen" (p. 19).

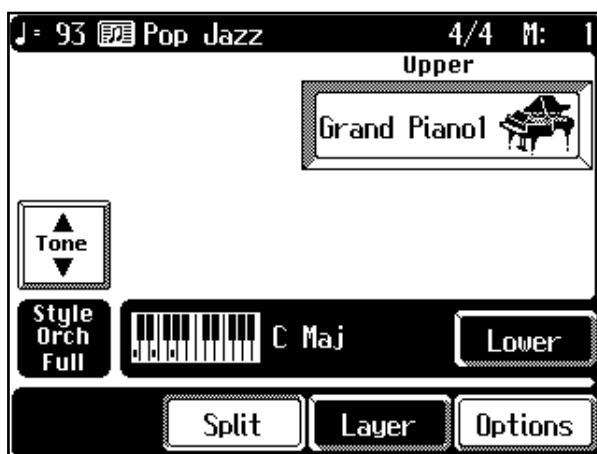

#### 2. Press the [Jazz] button.

The following screen appears.



3. Touch Page < ◀ ▶ > and < ▶ ▶ > to switch pages, then touch the screen to choose <Big Band>.

4. Touch <Exit>.

The previous screen appears.

5. Use the Tempo [-] and [+] buttons to adjust the tempo of the accompaniment.

Press the [-] and [+] buttons at the same time to return to the basic tempo.

6. Finger the “C” key in the following figure to start play.

First an intro of 8 measures is played.

Play the right-hand and left-hand parts of the score on the keyboard.

Play the “C,” “F,” and “G” keys on the keyboard with the timing indicated for “C,” “F,” and “G” on the next page score for the left-hand part, as shown in the figure. There’s no need to hold down the key, so you can get ready to finger the next one.

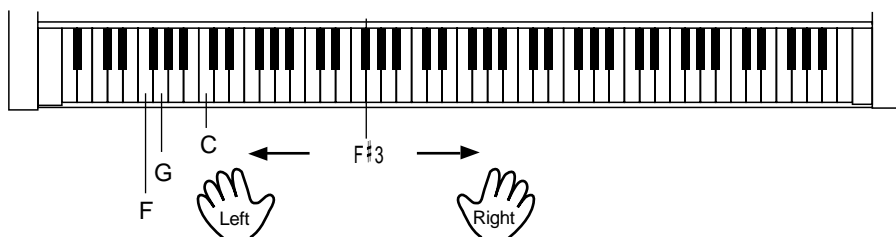

7. Press the Fill In [To Variation] button with the timing on the score.

The Accompaniment Pattern changes.

Pressing the [To Original] button returns you to the original accompaniment pattern.

Once you’ve familiarized yourself with the performance, try varying the timing for the accompaniment pattern as you like.

8. Press the Intro/Ending [1] button with the timing on the score.

After the ending plays, the accompaniment stops.

Pressing the Intro/Ending [2] button plays a simple ending.

## Little Brown Jug

Left

Play the C Key on the keyboard.

Intro 8 measures

Right

Left

C F G C

C F G C

Press the Fill In [To Variation] to change the Accompaniment Pattern.

To Variation

C F G C

C F G C

Press the Intro/Ending [1] to sound the Ending.



---

# MEMO

---

# Recording a Performance

## Recording a Song ([Composer Navigator] Button)

You can use the KF-90's "Composer" section for simple recording and playback of your performances.

When recording a song, try pressing the [Composer Navigator] button.

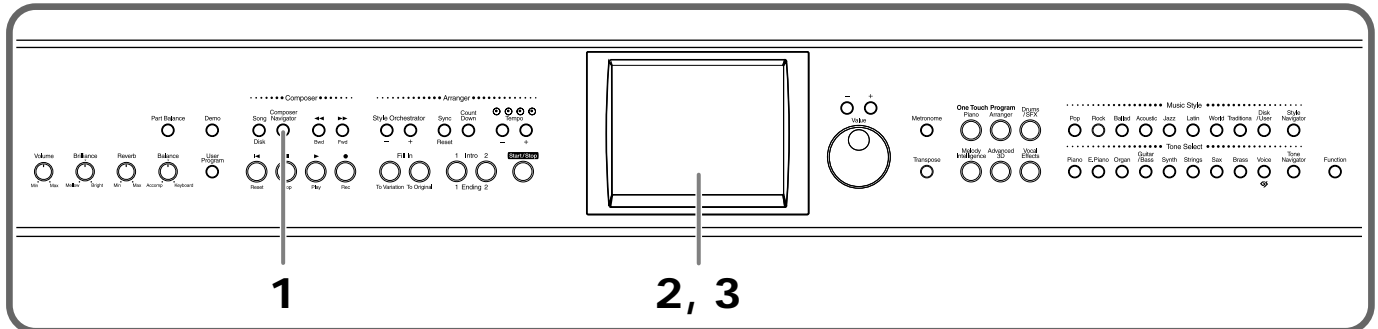

### 1. Press the [Composer Navigator] button.

A Composer Navigator screen like the one below appears.

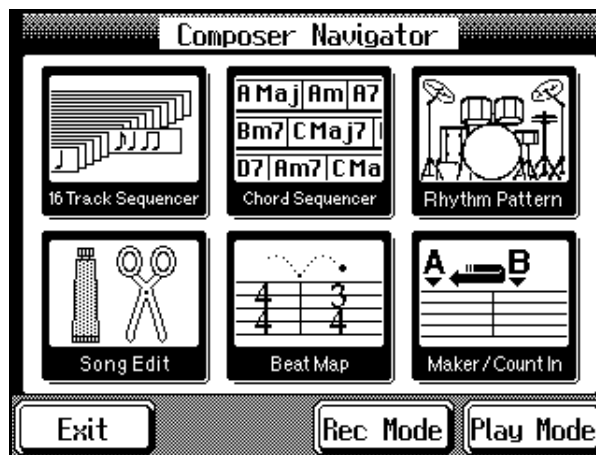

### 2. Touch the screen to choose the desired activity.

Display	Description
<b>16 Track Sequencer</b>	This allows you to record performance for up to 16 parts to create ensemble songs (p. 118).
<b>Chord Sequencer</b>	You can create an accompaniment only by entering its chord progression (p. 105).
<b>Rhythm Pattern</b>	Only selecting a rhythm pattern, you can record a rhythm part (p. 108).
<b>Song Edit</b>	You can edit a song by using a variety of ways (p. 124).
<b>Beat Map</b>	You can create songs that have beat changes during the course of the song (p. 122).

---

Display	Description
<b>Maker/Count In</b>	You can set a marker at a point within a song and then go immediately to that measure, and have a count-in be sounded before the performance starts (p. 90).
<b>Rec Mode</b>	Use this mode when making changes in the recording method and the manner in which recording is to be stopped (p. 103).
<b>Play Mode</b>	By changing the settings, you can play back portions of the data using tones particular to the KF-90 (p. 149).

Touch <Exit> to go back to the Composer Navigator screen.

- 3. Touch <Exit> at the bottom left of the screen to end the Composer Navigator screen.**

# Recording a Performance with Automatic Accompaniment

In this section, we'll record a performance with Automatic Accompaniment for "Little Brown Jug" on page 32.

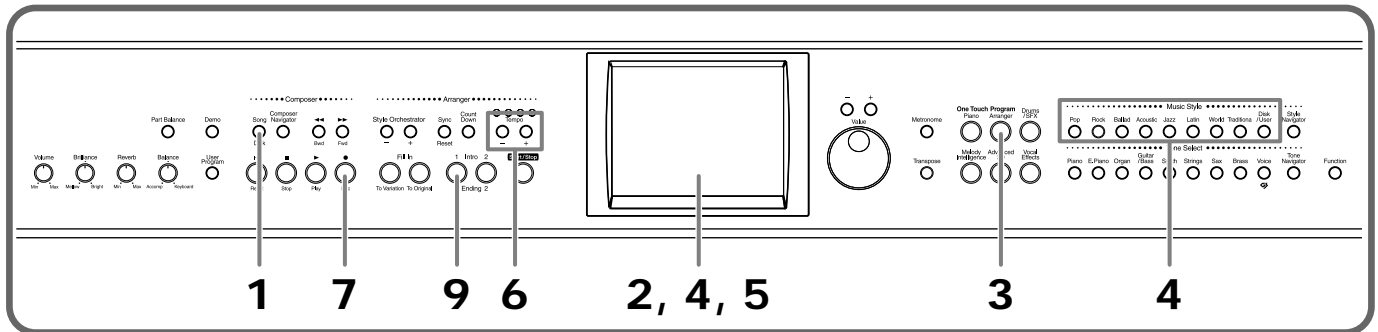

## Get ready to Record

1. Press the [Song/Disk] button.

The following screen appears.



2. Touch <0:> to display <0:New Song> on the screen.

If <0:> doesn't appear on screen, touch Page < ◀ > and < ▶ > to switch screens. Touch <Exit> to go back to the previous screen.

## Get ready to play

3. Press the One Touch Program [Arranger] button.
4. Use the Music Style buttons and the touch screen to choose a Music Style you want to play.

In the same way as on page 32, when you play "Little Brown Jug," press the [Jazz] button, then choose <Big Band>.

5. Touch <Exit> to go back to the previous screen.
6. Use the Tempo [-] and [+] buttons to adjust the tempo of the accompaniment.

### Start recording

7. Press the Rec [ ● ] button.

The KF-90 enters standby for recording.  
To stop recording, press the Stop [ ■ ] button.

8. Play on the left-hand section of the keyboard.

Automatic accompaniment starts, and recording is started at the same time.  
Now begin playing.

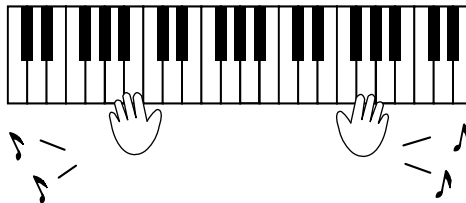

### Stop recording

9. Press the Intro/Ending [1] button.

An ending is played, then the automatic accompaniment stops, and recording is stopped at the same time.

### ● When the Following Screen is Displayed

If there's song data remaining in the internal memory, the screen shown below appears when you try to choose a song.



### If you don't want to erase the song

Touch <Cancel>.

Save the song on a floppy disk.

For information on how to save your song, see "Saving Songs to Floppy Disks" (p. 109).

### Erasing a song

Touch <OK>.

The recorded performance or song whose settings have been changed is erased.

## Listening to the Recorded Performance

Now listen to the performance you have recorded.

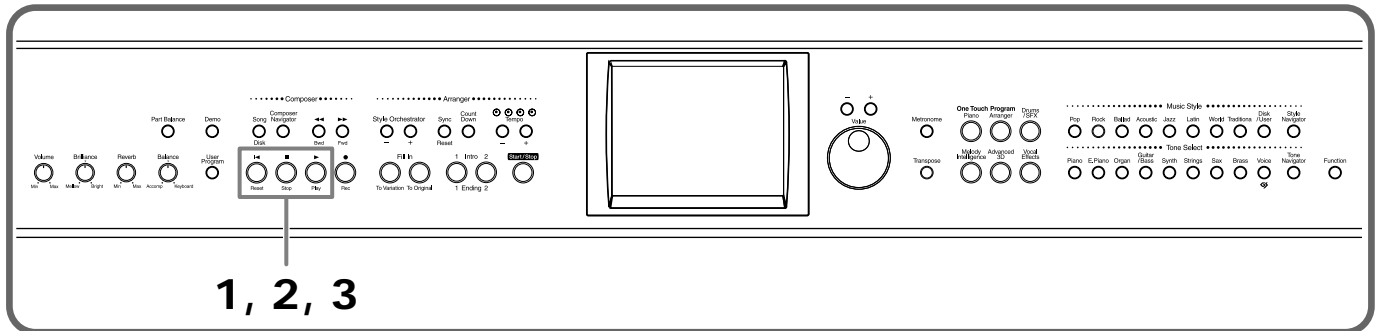

**1. Press the Reset [◀] button.**

Now, you can play back the song from the beginning.

**2. Press the Play [▶] button.**

The recorded performance is played back.

**3. Press the Stop [■] button.**

Playback stops.

**NOTE** Any performance that has been recorded is deleted when the power to the KF-90 is turned off. If you don't want to lose your recorded performance, save it on a floppy disk. For information on how to save your song, see "Saving Songs to Floppy Disks" (p. 109).

**NOTE** If there's a recorded performance in the KF-90's internal memory, you can't play back another song. Check out "Erasing a Recorded Song" (p. 102).

# Using Music Files

## Listening to Music Files

Here's where you can know how to use the disk drive to listen to commercially available music files.

You can also listen to KF-90 performance data saved on a floppy disk in the same way.

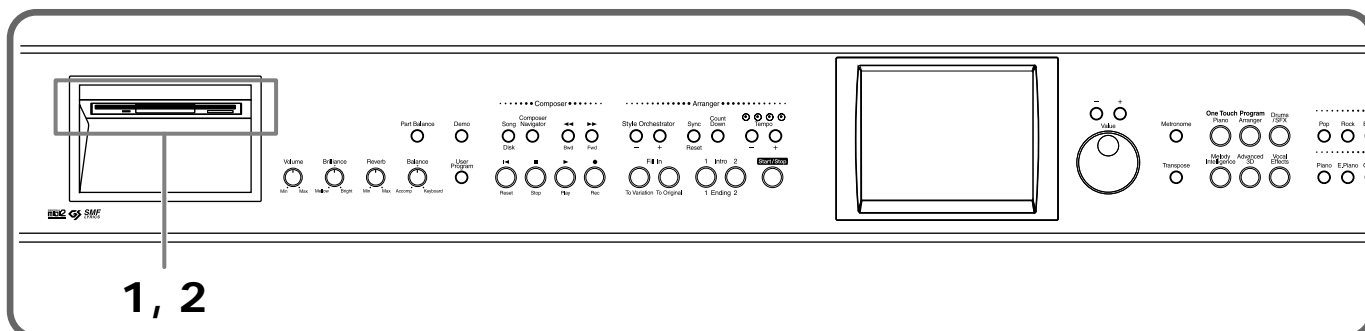

### ■ Inserting and Ejecting a Floppy Disk

**NOTE**

If you're using the disk drive for the first time, be sure to read the important notes on p. 6.

1. **Hold the floppy disk face up, and push it into the disk drive until it clicks into place.**

The disk drive is on the left side of the front panel.

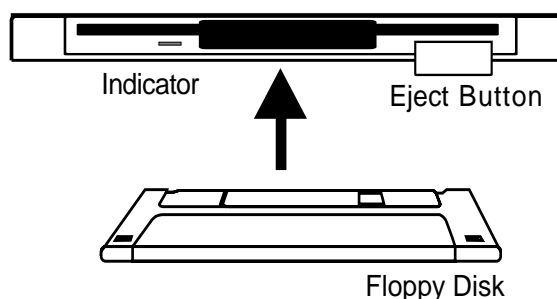

**NOTE**

Never eject a disk while reading or writing is in progress, since that can damage the magnetic surface of the disk, rendering it unusable. (The disk drive's indicator will light up at full brightness when the drive is busy reading or writing data. Ordinarily, the indicator will be less brightly lighted, or be extinguished.)

2. **To remove a disk, press the EJECT button.**

The end of the floppy disk comes out of the slot. Gently grasp the end of the floppy disk and pull it out.

## ■ Playing Back Music Files

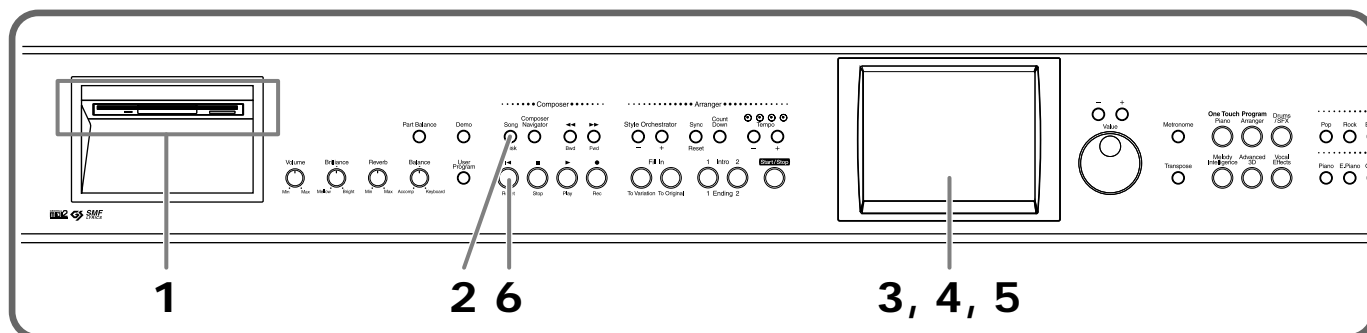

**1. Insert the floppy disk containing the songs into the disk drive (p. 39).**

**2. Press the [Song/Disk] button.**

The Song/Disk screen appears.



**3. Touch the screen to choose a song.**

If there are more than five songs on the disk, touch Page < ◀ ▶ > to switch the pages.

Touching <  > displays various information about the song you selected.

**4. Touch < ▶ > on screen to play back the song.**

You can also start playback by pressing Play [ ▶ ] button.

The on-screen < ▶ > changes to < ■ >.

**5. To stop playback of the song, touch < ■ > on the screen.**

You can also stop playback by pressing the Stop [ ■ ] button.

If you let the selected song play to the end, playback stops automatically.

The on-screen < ■ > changes to < ▶ >.

**6. Press the Reset [ ◀ ] button to go back to the beginning of the song.**



When you play a song with an upbeat (in other words, a song that starts before the first beat), the screen like the Basic screen (p. 19) shows PU, 1, 2, and so on as the measure numbers.



### ● When the Following Screen is Displayed

If there's song data remaining in the internal memory, the screen shown below appears when you try to choose a song.



#### If you don't want to erase the song

Touch <Cancel>.

Save the song on a floppy disk.

For information on how to save your song, see "Saving Songs to Floppy Disks" (p. 109).

#### Erasing a song

Touch <OK>.

The recorded performance or song whose settings have been changed is erased.

## ■ Playing Back All Songs Continuously (All Song Play)

You can continuously repeat playback of all the songs. This function is called "All Song Play."

1. Insert the floppy disk containing the songs into the disk drive.
2. Press the [Song/Disk] button.



3. Touch <  > on the screen.

All songs are played back in sequence. The on-screen <  > changes to <  >.

When the last song has finished playing, playback then repeats after returning to the first song.

4. Press the Stop [  ] button or touch <  > on screen to stop playback of the songs.

---

# Enjoying Karaoke Performances with Music Files

---

You can connect a microphone into the Mic jack, and enjoy karaoke with the KF-90.



For more on connecting a microphone, refer to “Connecting a Microphone” (p. 18).



Karaoke music files must be purchased separately. When purchasing music files, please consult the vendor where you bought the KF-90. Check out “Music Files That the KF-90 Can Use” (p. 183).

## 1. Connect the microphone, then adjust the volume with the [Mic Volume] knob on the back of the KF-90.

You can also adjust the depth of the Mic echo. (p. 44)

You can also enjoy this with the Voice Transformer function (p. 44) and Harmonist function (p. 46).

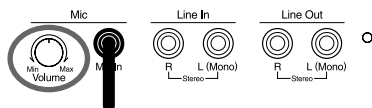

## 2. Insert the floppy disk that contains music files into the disk drive.

Please refer to “Inserting and Ejecting a Floppy Disk” (p. 39).

## 3. Press the [Song/Disk] button.

The Song/Disk screen appears.

## 4. Touch the screen to choose a song.

Touch <Exit> several times, the Basic screen (p. 19) appears.

## 5. If you need to, use the Tempo [-] [+] buttons to adjust the tempo.

## 6. If necessary, change the key of the song.

You can transpose a song being played back to match the pitch range of your voice when you sing along with it. For details, refer to “Transposing a song for playback” (p. 94).

## 7. Press the Play [▶] button to begin playback of the song.

Sing a song along with music.

When you play back a Music File with lyrics, the lyrics appear on screen.

## 8. Press the Stop [■] button to stop playback.



You can hide lyrics, if you like. Take a look at “Hiding the On-screen Lyrics” (p. 153).

# Adding the Effects to Your Voice

You can connect a microphone into the Mic jack, and enjoy modifying your voice through the mic with the KF-90.

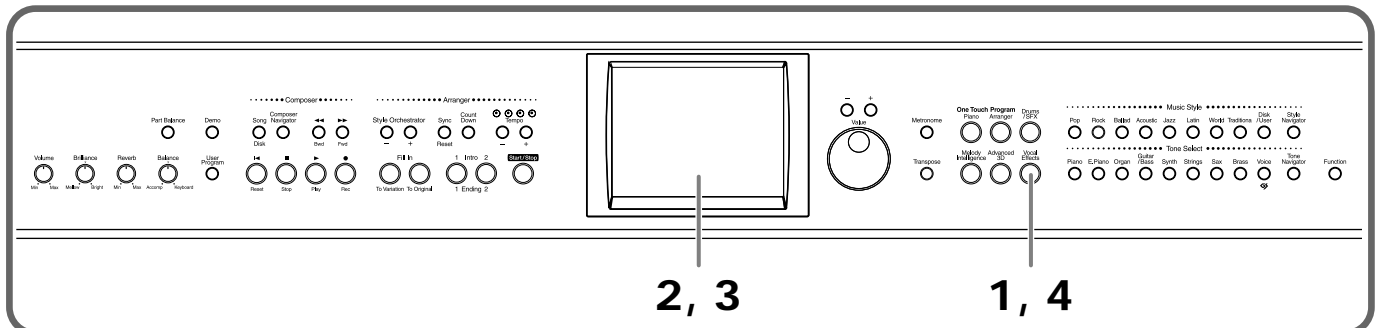

## 1. Press the [Vocal Effects] button.

A Vocal Effects screen appears.

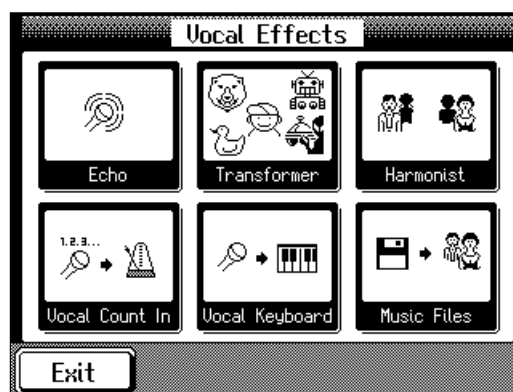

## 2. Touch the screen to choose the desired activity.

Display	Description
<b>Echo</b>	Adjusting the Mic echo (p. 44).
<b>Transformer</b>	Modifying your voice sounds (p. 44).
<b>Harmonist</b>	Adding harmony to your voice (p. 46).
<b>Vocal Count In</b>	You can start a song or Automatic Accompaniment by your counting (p. 47).
<b>Vocal Keyboard</b>	Plays the keyboard notes with a voice scale (p. 48).
<b>Music Files</b>	You can have a specified part played as harmony while a song is played back (p. 48).

Touch <Exit> to go back to the Vocal Effects screen.

3. Touch <Exit> to go back the previous screen with the Vocal Effect function still in effect.
4. To cancel the Vocal Effects, press the [Vocal Effects] button to go out the button's indicator.

## ■ Adjusting the Echo

You can adjust the echo added to the sound from a microphone connected to the KF-90.

1. Press the [Vocal Effects] button.

A Vocal Effects screen appears.

2. Touch <Echo>.

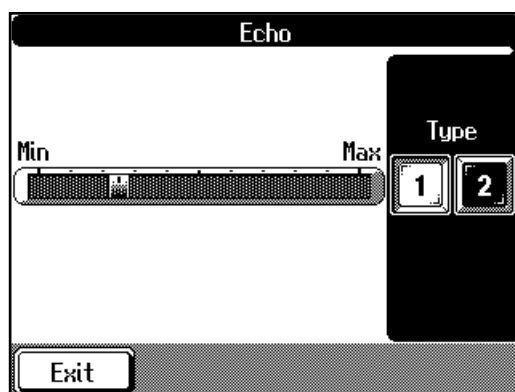

3. Touch <Echo> horizontal slider to adjust the amount of echo applied.
4. Touch Type <1> or <2> to change the type of echo.

Display	Description
1	Adds clear reverberations.
2	Adds reverberations like a karaoke-type echo.

Touch <Exit> to go back to the Vocal Effects screen.

## ■ Modifying Your Voice

With the KF-90, you can modify the way your voice sounds through the microphone. This is called the “Voice Transformer” function.

1. Press the [Vocal Effects] button.





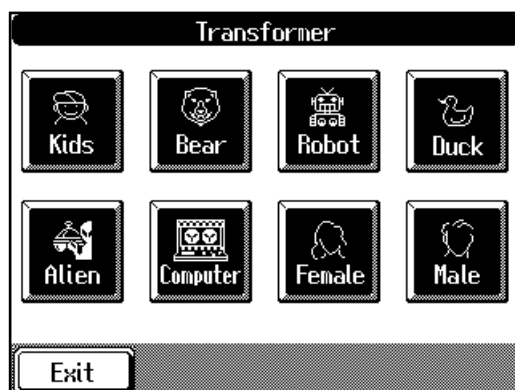



The Vocal Effects screen appears.

2. Touch <Transformer>.



### 3. Touch one of the icons on the screen.

Here's what the different icons do.

Display	Description
 Kids	Makes your voice sound like a child's.
 Bear	Makes your voice sound like a big animal's.
 Robot	Makes your voice sound like a robot's.
 Duck	Makes your voice sound like a duck's.
 Alien	Makes your voice sound like an alien's.
 Computer	Makes your voice sound like computer.
 Female	Makes a man's voice sound like a woman's.
 Male	Makes a woman's voice sound like a man's.

### 4. Sing through the microphone.

Your voice is transformed according to the item you selected.

**NOTE** When you use the Voice Transformer function, the resonance setting for the piano (see p. 144) may sometimes be reset.

### 5. Touch the icon you selected in step 3 again to cancel the Voice Transformer function.

Touch <Exit> to go back to the Vocal Effects screen.

## ■ Adding Harmony

You can sing with a harmony accompaniment, even when you're playing solo. This is called the "Harmonist" function.

### 1. Press the [Vocal Effects] button.





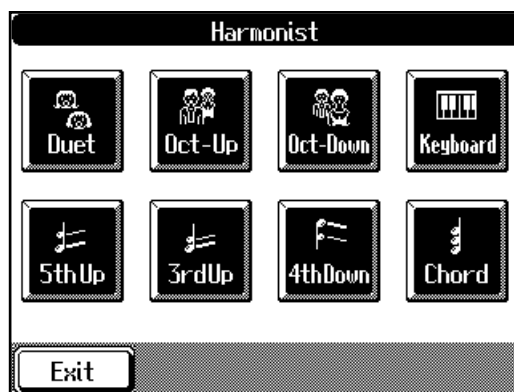

The Vocal Effects screen appears.

### 2. Touch <Harmonist>.

Now you can use the Harmonist function.



### 3. Touch one of the icons for <Harmonist> to choose how to apply the harmony.

Display	Description
	This provides an effect similar to that of two people singing a melody in unison.
	This applies a voice modified by Voice Transformer to your own voice. If you don't use the Voice Transformer function, this lets you sing with a voice one octave higher.
	This applies a voice modified by Voice Transformer to your own voice. If you don't use the Voice Transformer function, this lets you sing with a voice one octave lower.
	When you finger the keyboard, the notes played are added to your voice as harmony.
	This adds a harmony a Major fifth above your own voice.
	This adds a harmony a Major 3rd above your own voice.
	This adds a harmony a Major fourth below your own voice.

Display	Description
	Harmony is added to the chords you play on the keyboard.

**NOTE** When you use the Harmonist function, the resonance setting for the piano (p. 144) may sometimes be reset. And the effects applied to the keyboard may be canceled.

**4. Touch the icon you selected in step 3 again to cancel the Harmonist function.**

Touch <Exit> to go back to the Vocal Effects screen.

## ■ Starting Song and Automatic Accompaniment by Vocal Count

You can start the song and Automatic Accompaniment by giving the count through the microphone.

**1. Press [Voice Effects] button.**

The Vocal Effects screen appears.

**2. Touch <Vocal Count In>.**



**3. Select <Song> or <Arranger>.**

Display	Description
<b>Arranger</b>	After your counting, the Automatic Accompaniment will start.
<b>Song</b>	After your counting, the song will start.

**4. Count to four (“One, two, three, four”) into the mic.**

Be sure to count to four.

The tempo is set to the timing you counted using the microphone.

The song or Automatic Accompaniment will start.

Touch <Exit> to go back to the Vocal Effects screen.

## ■ Playing the Keyboard Notes with a Voice Scale

You can have the melody that is sung into the microphone played using the KF-90's tones.

**NOTE**

When <Vocal Keyboard> function is ON, the Voice Transformer (p. 44) and the Harmonist function (p. 46) are disabled. Both <Vocal Keyboard> and the Voice Transformer or the Harmonist cannot be selected simultaneously.

1. Press the [Vocal Effects] button.
2. Touch <Vocal Keyboard>.

If <OFF> icon is selected, touch <ON> to apply the effect.



3. Touch the one of the icons to select the tone for the keyboard.

You can also select the Tone by using the Tone Select button (p. 24).

Now, you can playing the keyboard notes with a vocal scale. The Tone you've selected is heard when you finger the keyboard.

4. Touch <OFF> to cancel the Keyboard function.

## ■ Adding the Harmony to the Song

When you sing along with the playback of a specified part in the song data, harmony is added using the scale for the specified part.

**NOTE**

When <Music Files> is selected, the Voice Transformer function (p. 44) is disabled. Both <Music Files> and the Voice Transformer cannot be selected simultaneously.

1. Select a song you want to add the harmony.

If you use the song on floppy disk, insert the floppy disk.

About selecting a song of floppy disk, please refer to page 40.

2. Press [Vocal Effects] button.

3. Touch <Music Files>.



4. Touch one of the icons to select a performance part.

A matching harmony is added to the performance of the part you chose.

5. Touch the icon you selected in step 4 again to cancel the Music Files function.



**Roland**

Digital Intelligent Piano KF-90



# *Reference*

Chapter 1

Chapter 2

Chapter 3

Chapter 4

Chapter 5

Chapter 6

Chapter 7

Chapter 8

Chapter 9

Appendices

# Chapter 1 Performance

## Playing the Keyboard Like a Piano (One-touch Piano)

You can make the optimal settings for a piano performance at the touch of a single button.

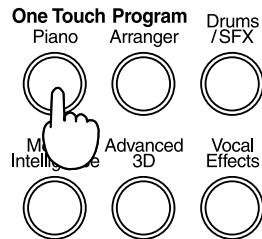

### 1. Press the One Touch Program [Piano] button.

A Piano screen like the one shown below appears.

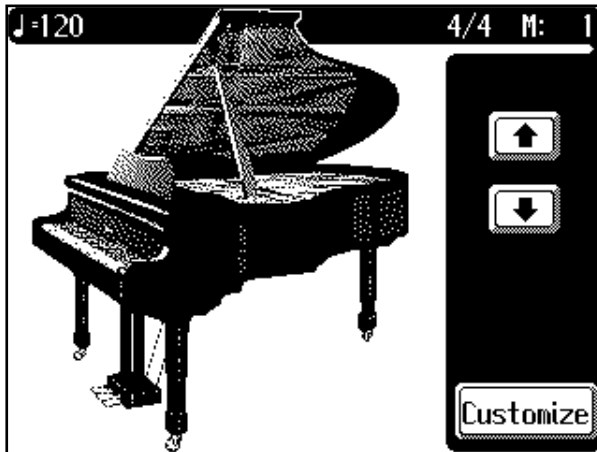

Settings are made for the following situations.

- The Grand Piano sound is selected.
- When the keyboard has been split into upper and lower sections (p. 55), this returns the keyboard to a single section.
- The functioning of the pedals returns the pedals to their usual functions (p. 16).
- The effect (p. 62) is set to “Sympathetic Resonance.”

### Changing the Piano Sound

#### 1. Touch next to the illustration of the piano.

The amount by which the piano’s top is opened changes, and the sound also changes.

This simulates the sound reflections that occur when the lid of a grand piano is open.



Since this instrument faithfully reproduces real acoustic piano action and response, sounds in the top one-and-one-half-octave range continue to play, regardless of the damper pedal action, and the tone in this range is audibly different. The Key Transpose setting (p. 93) can also be used to change the range that is unaffected by the damper pedal.



You can change settings related to the piano performance by touching <Customize> at the bottom of the screen. For more information, take a look at “Changing the Settings for One Touch Piano” (p. 142).

## Playing a Wide Variety of Instrument Sounds

The KF-90 comes with a large number of built-in instrument sounds and effects. This lets you enjoy performances with sounds matched to a wide range of musical genres. The various types of built-in sounds are called “Tones.” The tones are divided into nine separate groups, each assigned to one of the nine “Tone Select” buttons.

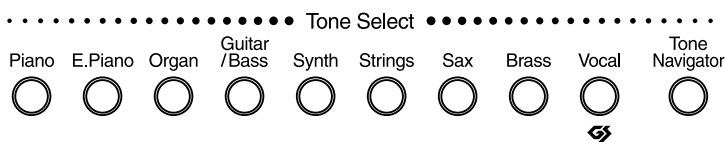

### 1. Press one of the Tone Select buttons to choose a Tone Group.

The pressed Tone Select button's indicator lights.

The screen shows six of the Tones included in the chosen Tone Group.



This screen is called the “Tone Selection” screen.

### 2. Use Page <◀> and <▶> to switch screens, and touch the screen to choose a Tone.

The Tone you've selected is heard when you finger the keyboard.

Also, the next time you press the Tone Select button you chose in step 1, the tone you selected here is sounded.

You can audition tones by listening to a typical phrase for the Tone by touching <Audition> at the bottom right of the screen.

Touch <Exit> to go back to the previous screen.

### About <EX> Tone

These are tones that Roland recommends you use in order to enjoy enhanced expressive capabilities.

Some of the EX Tones change according to the force with which the keys are played (velocity).



For more about the names of Tones, take a look at the “Tone List” (p. 166).



For information on the Tone Navigator button, take a look at the “Handy Features for Selecting Tones ([Tone Navigator] Button)” (p. 25).



For information on the Effects, take a look at the “Applying Effects to the Sound (Effects)” (p. 62).

### Changing Tones with Value [-] [+] Or the Dial

You can also use Value [-] [+] or the dial to change a Tone. When you use the Value [-] [+] button or the dial, the pages are switched automatically, without having to touch Page < ◀ > and < ▶ >.

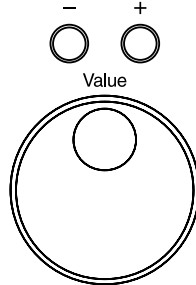

- 1. Press one of the Tone Select buttons to choose a Tone Group.**  
A Tone Selection screen appears.
- 2. Use the Value [-] and [+] buttons or the dial to select a Tone.**  
The indicator for the corresponding Tone Select button blinks.
- 3. Finger the keyboard or press the blinking Tone Select button to decide your selection.**

The Tone Select button's indicator lights up steadily. The Tone you've selected is heard when you finger the keyboard. Also, this is the Tone that you'll hear the next time you choose this Tone Select button.

Touch <Exit> to go back to the previous screen.

## Combining the Sounds of Two Instruments (Layer Play)

You can play two different sounds from a single key at the same time. This method of performance is called “Layer Play.” For instance, it’s possible to play the Tones for both Piano and Strings in combination.

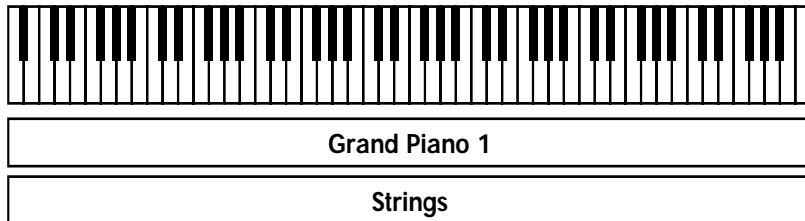

1. At the Basic screen, touch <Layer> at the bottom of the screen.

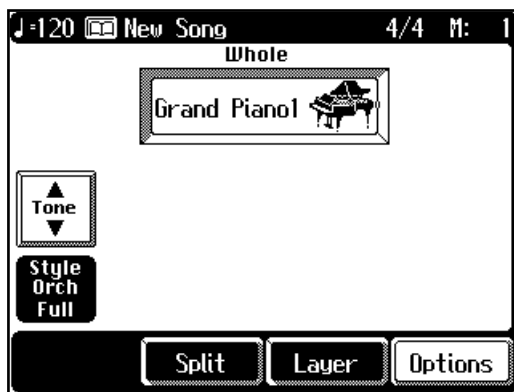

The screen changes as shown below.



This tone displayed in the lower section is called the “Layer Tone.”

When the keys are played, the tone selected in Step 1 and the Layer Tone are played together.

2. To cancel the Layer Play, touch <Layer> a second time.

When you finger the keyboard, only the sound displayed at the upper area of the screen is played.



Basic Screen (p. 19)



You can change the volume level for each of the Tones. Check out “Adjusting the Volume of Each Performance Part” (p. 81).

### Changing the Tones

1. On the Touch Screen, touch the name of the Tone you want to change.

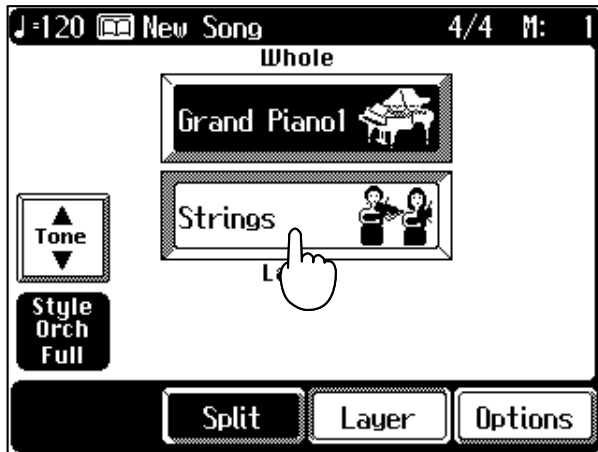

2. Press one of the Tone Select buttons.  
The Tone Selection screen appears.
3. Use Page < ◀ > and < ▶ > to switch screens, and touch the screen to choose a Tone.  
You can also select a Tone using the Value [-] and [+] buttons or the dial.
4. Touch <Exit>.  
The Basic screen appears.  
When you finger the keyboard, the selected Tone and the other Tone are played.



If you touch <- Oct> and <+ Oct> at the bottom of the Tone Selection screen, the pitch will change in one-octave steps. To learn more, check out “Shifting the Keyboard Pitch in Octave Steps (Octave Shift)” (p. 57).

## Playing Different Tones with the Left and Right Hands (Split Play)

The Split feature allows you to split the keyboard into two zones, then play a different sound in each zone.

Such a division of the keyboard into right- and left-hand sections is called a “Split,” and the key where the division takes place is called the “Split Point.” The split-point key is included in the left-hand section. Each time power to the keyboard is turned on, the split point is reset to “F#3.”

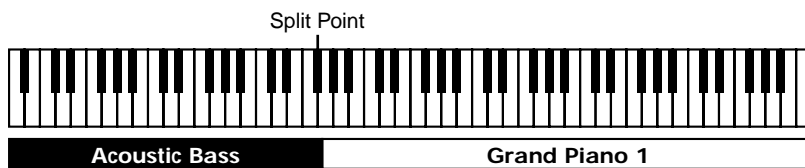

### • Switching to Split Play directly from Layer Play

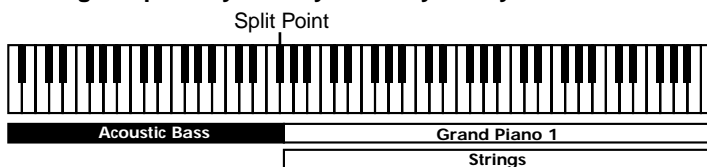

## 1. At the Basic screen, touch <Split>.

The tone in the right-hand part remains the same as it was before the keyboard was split, and the tone in the lower part switches to the tone displayed on the upper left part of the basic screen.

In this case, the tone in the right portion of the keyboard is called the “Upper Tone,” and the tone in the left portion of the keyboard is called the “Lower Tone.”

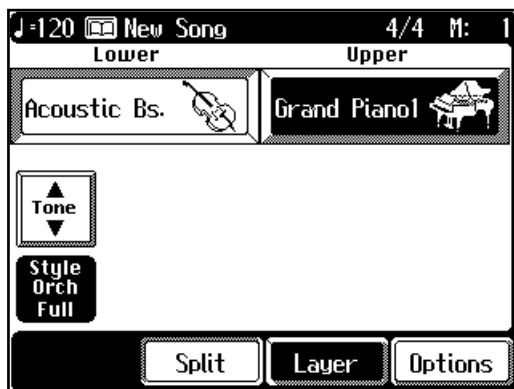

## 2. To cancel the Split Play, touch <Split>.

The tone in the upper part then is effective for the entire keyboard.



You can change the split point. Please refer to “Changing the Keyboard’s Split Point” (p. 145).



When you switch to Split mode directly from Layer Play (p. 53), the two tones played in Layer Play become the tone of the right hand of the keyboard in Split mode.



Basic Screen (p. 19)



You can independently adjust the volume levels of the notes played by the upper and lower sections of the keyboard. Check out “Adjusting the Volume of Each Performance Part” (p. 81).



When the keyboard has been divided into upper and lower sections, the damper pedal is applied to only the upper section. If you want to add lingering reverberations to the notes of the lower section, see “Assigning Functions to Pedals” (p. 147).

## Changing the Tones

1. **On the Touch Screen, touch the name of the Tone you want to change.**
2. **Press one of the Tone Select buttons.**  
The Tone Selection screen appears.
3. **Use Page <◀> and <▶> to switch screens, and touch the screen to choose a Tone.**  
You can also choose a Tone using the Value [+ ] and [- ] buttons or the dial.
4. **Touch <Exit>.**  
The Basic screen appears.  
Play the keyboard to hear the Tone you selected.

### ■ Selecting a Different Tone in the Current Tone Group

You can select a tone in the currently selected Tone group without using the Tone Select buttons.

1. **Display the Basic Screen (p. 19).**
2. **Touch <Tone> on screen.**

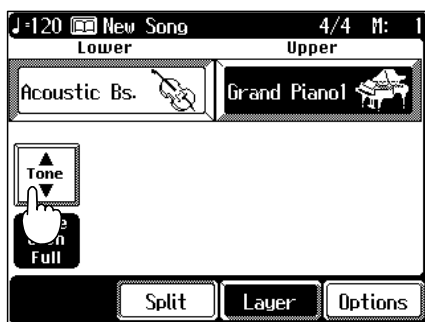

The tone selection screen appears.

3. **Touch an icon at the bottom of the screen to switch the Tone part.**

This allow you select a Tone of the Tone part displayed on the icon. Touching the icon changes the Tone part, and Tone selection screen switches of the currently Tone Group of the Tone part.

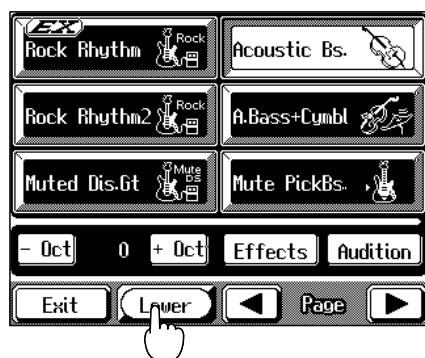

When the Split Play setting is in effect, <- Oct> and <+ Oct> appear at the bottom of the Tone Selection screen. Touching these changes the pitch of the keyboard by octaves. To learn more, check out “Shifting the Keyboard Pitch in Octave Steps (Octave Shift)” (p. 57).



Touching <Split> to cancel the split function during Automatic Accompaniment activates the Piano Style Arranger. Take a look at “Adding Automatic Accompaniment to Regular Piano Performance (Piano Style Arranger)” (p. 80).



The Tone part name is displayed at the above or below the Tone name at the Basic screen.



4. Use Page <◀> and <▶> to switch screens, and touch the screen to choose a Tone.  
You can also choose a Tone using the Value [-] and [+] buttons or the dial.
5. Touch <Exit>.  
The Basic screen appears.

## Shifting the Keyboard Pitch in Octave Steps (Octave Shift)

When the keyboard has been set up so that the right-hand and left-hand parts play different sounds (Split Play → p. 55) or so that the sounds for two instruments are played in combination (Layer Play → p. 53), you can shift the pitch of the notes you play by an octave at a time. This function is called “Octave Shift.”

For instance, you can make the pitch of the keyboard’s left-hand part match the pitch of the right-hand part during Split Play. Or, you could change the pitch of each tone, and play both tones together during Layer Play.

1. Make sure the Basic screen is displayed.
2. Touch <Layer> or <Split> to select Layer play or Split play.
3. Touch the tones on which to use Octave Shift on the touch screen.
4. Touch <Tone>.  
The Tone Selection screen appears.
5. Touch <- Oct> and <+ Oct> at the bottom of the screen to adjust the pitch of the sound.



Each touch of <+ Oct> raises the pitch one octave.

Each touch of <- Oct> lowers the pitch one octave.

You can vary the pitch within a range down two octaves or up two. The state of the pitch is displayed at the bottom of the screen.

6. Touch <Exit> to go back to the Basic screen.

### NOTE

You can't use this feature when set up so that the entire keyboard is played as a single instrument.

### MEMO

Basic Screen (p. 19)

# Playing Drum Sounds

You can use the keyboard to play percussion sounds or effects such as sirens and animal sounds.

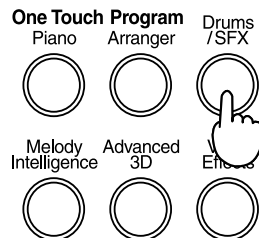

### 1. Press the [Drums/SFX] button, getting its indicator to light up.

When you finger the keyboard now, each key plays a different percussion-instrument sound.

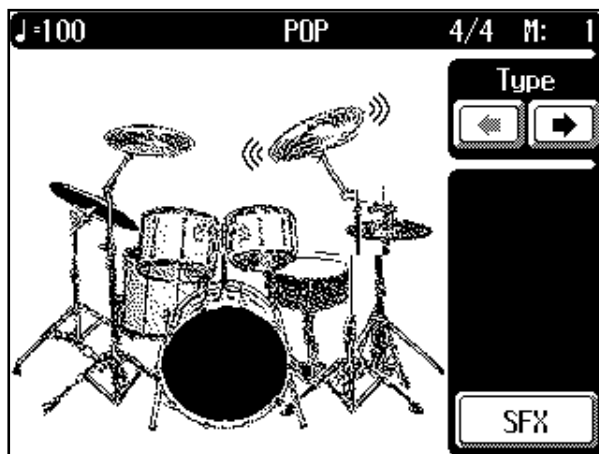

### 2. Touch <Type> ◀ ▶ to change the type of drum set.

The drum set appears in the middle of the screen.

Sets of percussion sounds, such as “STANDARD,” are called “Drum Sets.”

Each drum set contains a wide variety of percussive instrument sounds and sound effects, and each key plays a different sound.

You can play the Drum sound by touching the figure of drum set on the Drum screen.

### 3. Pressing the [Drums/SFX] button again to return to the previous sound.

The [Drum/SFX] button’s indicator goes out, and you are returned to the previous screen.

The sound played with the keyboard reverts to the instrument sound used before the [Drums/SFX] button was pressed.



The combination of sounds assigned to the keyboard varies according to the drum set. Take a look at the “Drum/SFX Set List” (p. 170).

## ■ Playing Effect Sounds

1. Press the [Drums/SFX] button, getting its indicator to light up.
2. Touch <SFX> at the bottom of the screen.

When you finger the keyboard now, each key plays a different effect sound. You can listen the Sound Effect by touching the icons on the SFX screen.

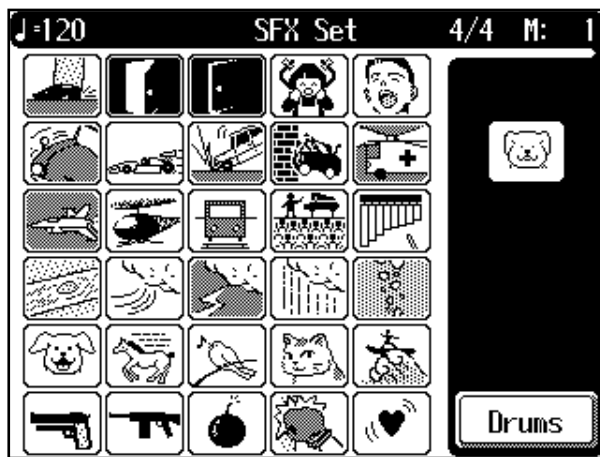

A set of effect sounds is called an “SFX set.”

Touching <Drums> at the bottom of the screen makes it so that percussion instruments are sounded.

3. Pressing the [Drums/SFX] button again to return to the previous sound.

The button’s indicator goes out, and the previous screen appears.

The sound played with the keyboard reverts to the instrument sound used before the [Drums/SFX] button was pressed.

## Adding Reverberation to Sounds (The Reverb Effect)

The KF-90 can apply a reverb effect to the notes you play on the keyboard. Applying reverb adds pleasing reverberation to what you play, so it sounds almost as if you were playing in a concert hall.

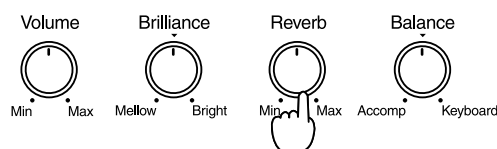

1. Adjust the [Reverb] knob to select the amount of reverb effect to be applied.

Rotating the knob clockwise applies a deeper reverb, and rotating it counterclockwise applies less reverb.



For the tones of the SFX set, refer to “Drum/SFX Set List” (p. 170).



You can change the type of reverb that’s applied. Please refer to “Changing the Type of Reverb Effect” (p. 151).



If you press the One Touch Program [Piano] button for the purposes of a piano performance, settings for the reverb effect that were made using the [Reverb] knob could get altered.

## Effects Adding Three-Dimensional Breadth to Your Performances (Advanced 3D)

When performing along with the automatic accompaniment or the songs, you can add three-dimensional breadth to the sounds. This provides the pleasant effect of “wrapping” your performance within the accompaniment.

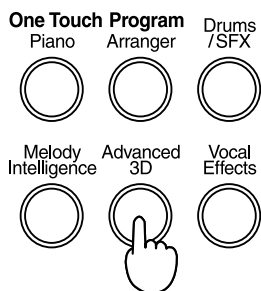

- 1. Press the [Advanced 3D] button.**  
The Advanced 3D screen appears in the display.
- 2. Touch the window icon to switch the effect on or off.**  
Three-dimensional breadth is added to the sound of the selected accompaniment part.

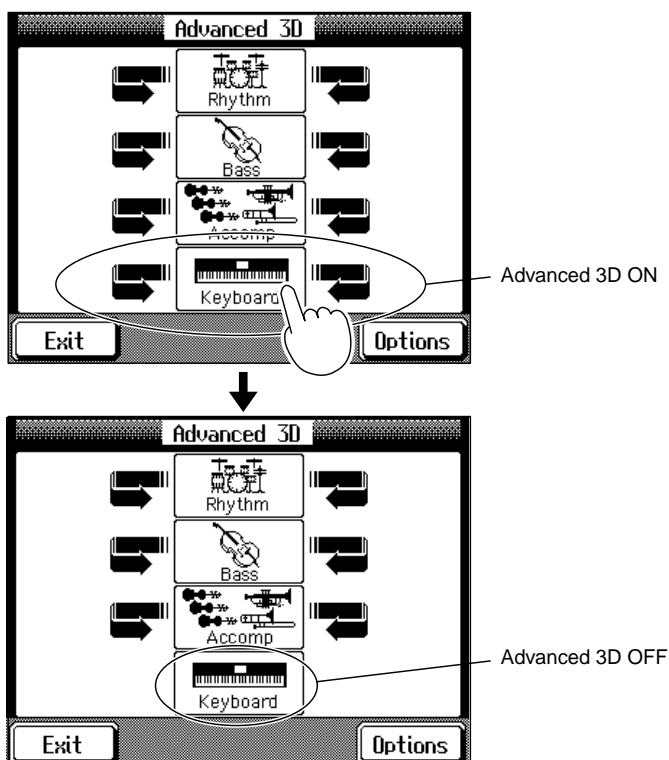

Touch <Exit> to go back to the previous screen with the Advanced 3D function still in effect.

- 3. Press the [Advanced 3D] button once more, extinguishing the button's indicator, to eliminate the effect.**

### Selecting the part to apply Advanced 3D Effect

With “Keyboard” in Advanced 3D set to On, you can select the Parts to which the 3D effect is applied when the keys are played.

#### 1. Touch <Options> at the Advanced 3D screen.

The following display appears.

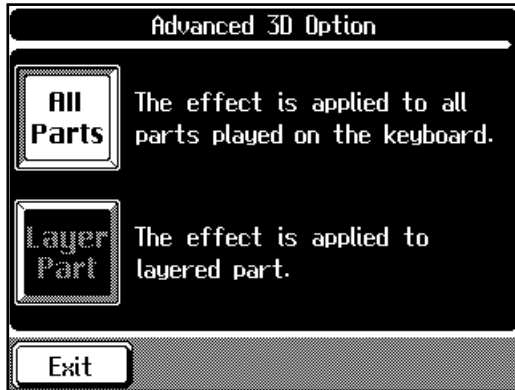

Display	Description
<b>All Parts</b>	The effect is applied to all Parts played on the keyboard.
<b>Layer Part</b>	The effect is applied to Layer Part. When the Layer play (p. 53) is not being used, the effect is not applied to what is played on the keyboard, even if “Keyboard” is set to On.

#### 2. Touch <All Parts> or <Layer Part>.

Touch <Exit> to go back the Advanced 3D screen.

## Applying Effects to the Sound (Effects)

You can apply a wide range of different effects to the notes you play on the keyboard.

1. **Press one of the Tone Select buttons to choose a Tone to which you want to apply an Effect.**

The Tone Selection screen (p. 51) appears.

2. **Touch <Effect> on the screen.**

The Effect screen appears.

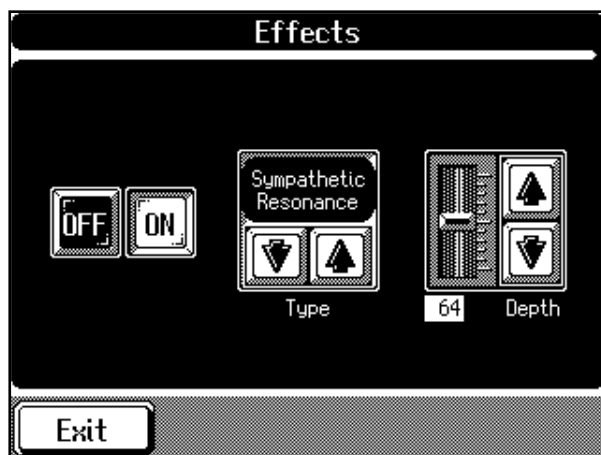

3. **Touch <ON>.**

The optimal effect for the keyboard sound is applied.

4. **Touch <Type>   to choose the type of effect.**

5. **Touch <Depth>   to adjust the amount of effect applied.**

Touch <Exit> to go back to the previous screen.

6. **To cancel the effect, touch <OFF> at the Effects screen.**

### About the Effects

When the effects is set to ON, the optimal effect is applied for the currently selected sound. Also you can apply effects for each tone. Although turning off the power returns the effects to their initial settings, carrying out Memory Backup (p. 154) allows you to save and store the effect settings even after the power is turned off.

### NOTE

When you press the One Touch Program [Piano], you cannot change the type of effects.

### NOTE

If you apply a different effect to the Layer tone (p. 53) or the Lower tone (p. 55) than the effect applied to the Upper tone (the tone shown in the upper right of the basic screen), the effect may not be applied in some cases. Select the same effect as for the Upper tone.

### MEMO

For more information on the different types of effects, take a look at the “Effects List” (p. 180).

### MEMO

You can select the type of chorus effect. Please refer to “Changing the Type of Chorus Effect” (p. 152).

### MEMO

The same effect will apply to all sounds of the [Voice/GS] button that are followed by a “GS” symbol. If you change the effect for these sounds, the effect will also change for other sounds with the “GS” symbol.

## Sounding the Metronome

The KF-90 features a built-in metronome functions.

You can start or stop the metronome sound simply by pressing the [Metronome] button. During playback of a song, or when performing with automatic accompaniment, the metronome sounds to the tempo and beat of the song in progress.

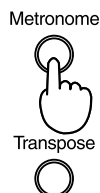

1. Press the [Metronome] button to start the metronome's sound.

The [Metronome] button's indicator lights up, and a Metronome screen like the one below appears.

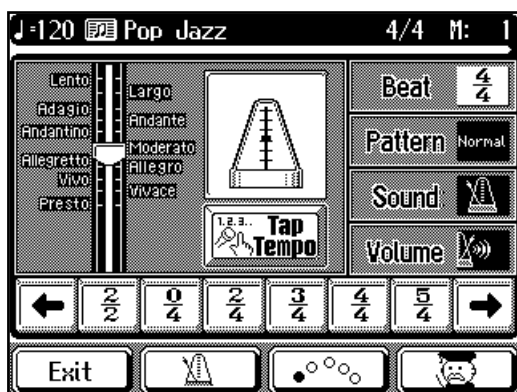

2. To stop the metronome's sound, press the [Metronome] button.

The [Metronome] button's indicator goes dark.



Touch <Exit> to go back to the previous screen.

### ■ Changing the Animation

A metronome that moves along with the tempo usually is displayed at the center of the Metronome screen. You can change this to an animated bouncing ball (a ball that moves along in time with the tempo), or other animation.

1. At the Metronome screen, touch the icons at the bottom of the screen.

The animation type will change.

	Metronome
	Bouncing Ball
	Doctor

## ■ Adjusting the Tempo

The tempo of the Metronome can be set within the range of 20 to 250. The tempo of the metronome changes automatically if you use an automatic accompaniment or play back a song.

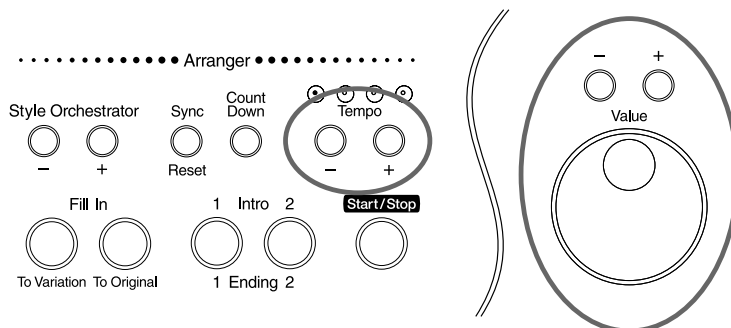

### 1. Press the Tempo [-] and [+] buttons to choose a tempo.

The setting is at “120” when the KF-90 is powered up.

You can also use the Value [-] [+] buttons or dial to adjust the tempo.

Turn the dial clockwise for a faster tempo, or counterclockwise for a slower tempo.

## ■ Determining the Tempo with Tempo Marks

You can set the tempo by choosing a tempo indicator, such as “Allegro,” indicated on the screen.

### 1. At the Metronome screen, touch the tempo mark on the screen.

The tempo is set to match the tempo mark.

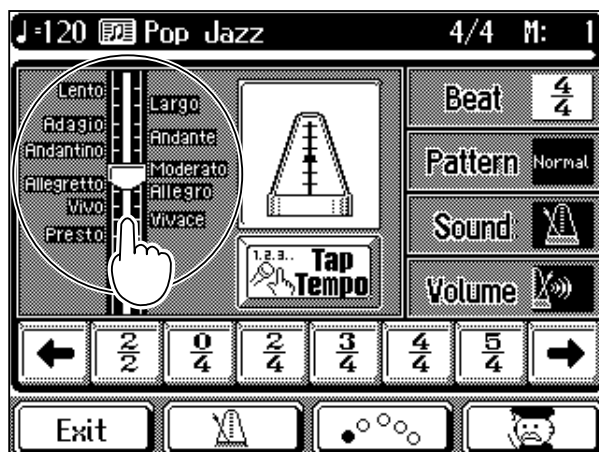

Even if you touch the bar graph on the screen directly, you can still change the tempo.





## ■ Changing the Beat of Metronome

### 1. At the Metronome screen, touch <Beat>.

The available choices for the beat appear at the bottom of the screen.

### 2. Choose the beat from among the selections by touching your choice.

You can scroll the display to one side or the other and show other choices for the beat by touching  .



When  $\frac{9}{4}$  is selected, only the upbeat will sound.



## ■ Changing How the Metronome Beat (Pattern) Sounds







The metronome usually sounds one beat per quarter note, but you can change the beat pattern to sound, for example, one beat for every dotted quarter note.

### 1. At the Metronome screen, touch <Pattern>.

The available choices for the type of pattern appear at the bottom of the screen.

### 2. Choose a pattern from among the selections by touching your choice.

You can scroll the display to one side or the other and show other choices for the pattern by touching  .

Display	Description
Normal	The metronome sounds in the ordinary way.
	Counting starts at the beginning of the measure, in intervals of dotted half-note upbeats.
	Counting starts at the beginning of the measure, in intervals of half-note upbeats.
	Counting starts at the beginning of the measure, in intervals of dotted quarter-note upbeats.
	Counting starts at the beginning of the measure, in intervals of quarter-note upbeats.
	Counting starts at the beginning of the measure, in intervals of dotted eighth-note upbeats.
	Counting starts at the beginning of the measure, in intervals of eighth-note upbeats.
	Counting starts at the beginning of the measure, in intervals of sixteenth-note upbeats.
+Doubl	Plays with backbeats as the added sound.
+Tripl	Plays with triplets as the added sound.
+Shufl	Adds a shuffle.



With a triplet beat ( $\frac{6}{8}$ ,  $\frac{9}{8}$ , or  $\frac{12}{8}$ ), added notes are sounded as triplets.

### ■ Changing the Type of Sound







You can change the type of sound of the metronome.

When you turn on the power, the setting is for “ordinary metronome sound.”

#### 1. At the Metronome screen, touch <Sound>.

The type of sound appear at the bottom of the screen.

#### 2. Touch the screen to select a metronome sound.

Display	Description
	Ordinary metronome sound
	Electronic metronome sound
いち、に、 ichi, ni,	A voice counting “1, 2, 3” in Japanese.
One, two,	A voice counting “1, 2, 3” in English
	Dog and cat cries
	Woodblock sound
	Triangle and castanet sounds
	Clapping

### ■ Changing the Volume



You can adjust the volume of the metronome to any of ten possible levels.

Metronome volume is set to “ (5)” when the keyboard is turned on.

#### 1. At the Metronome screen, touch <Volume>.

The available choices for the volume level appear at the bottom of the screen.

#### 2. Touch the volume icon you like.

Choosing  sets the volume to the lowest level, and choosing  sets it to the highest level.

Choose  to silence the metronome sound.

# Chapter 2 Using Automatic Accompaniment

## Music Style and Automatic Accompaniment

### What is Automatic Accompaniment?

With the KF-90, just by pressing the One Touch Program [Arranger] button, you can select Automatic Accompaniment. Automatic Accompaniment is a feature that immediately plays an optimal accompaniment based on the accompaniment pattern of the Music Style and the chords you finger on the keyboard. Using Automatic Accompaniment, you can play with an impressive accompaniment, even when you perform alone. Also, by varying the Music Style, accompaniment pattern, and chords, you can easily enjoy a wide range of arrangements of the same song.

For information on how to play Automatic Accompaniment, see “Choosing a Music Style” (p. 70).

### What’s a Music Style?

A Music Style is an accompaniment style that has been designed to fit in with a particular musical style.

There are many different varieties of music around the world, and each one has its own unique features. What gives jazz its “jazziness” and classical music its unmistakable classical feel is the unique combination of elements, such as the instruments used, melody, and phrasing, which interact to create the musical character of the genre. A Music Style makes use of such elements to bring out the distinctive atmosphere and mood of each musical genre.

### **The Makeup of a Music Style**

A Music Style is made up of a set of six performance states called “Divisions.”

Division	Description
<b>Intro</b>	This is the state when an intro is playing.
<b>Original</b>	This is the state where an Original accompaniment pattern is played.
<b>Variation</b>	This is the state where a Variation accompaniment pattern is played.
<b>Fill In to Original</b>	This is the state where a Variation fill-in is played.
<b>Fill In to Variation</b>	This is the state where an Original fill-in is played.
<b>Ending</b>	This is the state where an ending is played.

Also, a Music Style is made up of five performance parts: “Rhythm,” “Bass,” “Accompaniment 1,” “Accompaniment 2,” and “Accompaniment 3.”

## About Chords

A chord is a group of notes played at the same time. The pitch of the note that forms the base (the root note) is shown by a letter, and the type of constituent notes is shown by the chord type.

For instance, the chord “C Maj” has C (do) as the root note, and “Maj” (major) as the chord type. C Maj is composed of the three notes “C,” “E,” and “G.”

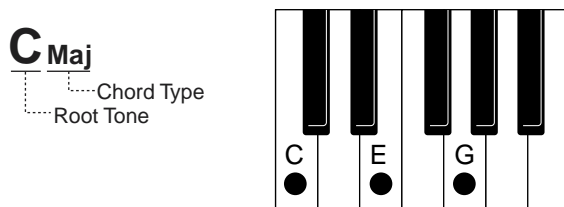

The root notes of chords are all indicated by a letter of the alphabet, # (sharp) and ♭ (flat), which correspond as follows.

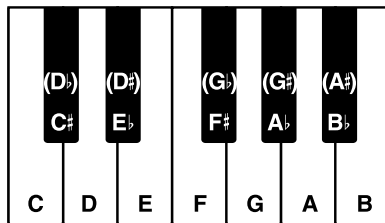

### ■ Playing Chords with Simple Fingering

“Chord Intelligence” is a feature that intelligently decides on accompaniment chords the moment you play a key (root note) specifying a chord during automatic accompaniment.

To play a C Maj chord, for example, you usually have to finger the three keys C, E, and G; but with Chord Intelligence, you only have to press the C key to initiate a C Maj chord accompaniment.

- How to play the chord in the Chord Intelligence mode

#### Major

Ex: C Maj



Play the chord root.

#### Minor

Ex: C min



Play the root and the third key above it.

#### Seventh

Ex: C 7



Play the root and the second key above it.

#### Minor Seventh

Ex: C min 7



Play the root, the third key above it, and the second key below it.

#### Major Seventh

Ex: C Maj 7



Play the root and the first key below it.

#### Diminished

Ex: C dim



Play the root and the sixth key above it.



For more information about chord fingering, refer to the “Chord List” (p. 178).



You can cancel the Chord Intelligence function. For more information, see “Canceling the Chord Intelligence Function” (p. 147).

## ■ Displaying the Chord Fingering On Screen (Chord Finder)

Whenever you are not sure how a certain chord is fingered, you can have the notes comprising the chord be shown in the screen.

### 1. Press the [Style Navigator] button.

The Style Navigator screen will appear.

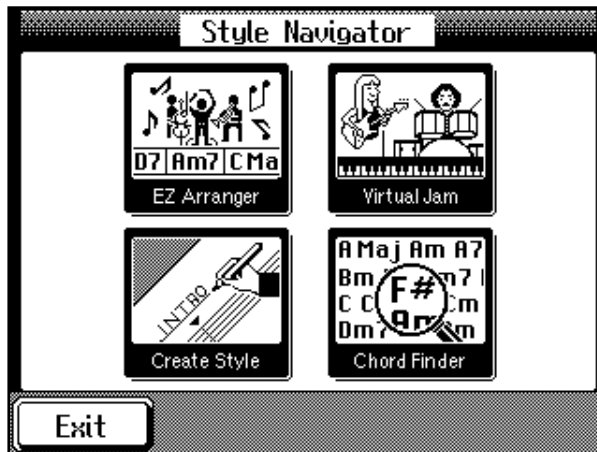

### 2. On the screen, touch <Chord Finder>.

### 3. Touch the screen to specify the root of the chord you want to learn about.

The chord fingering appears on screen.

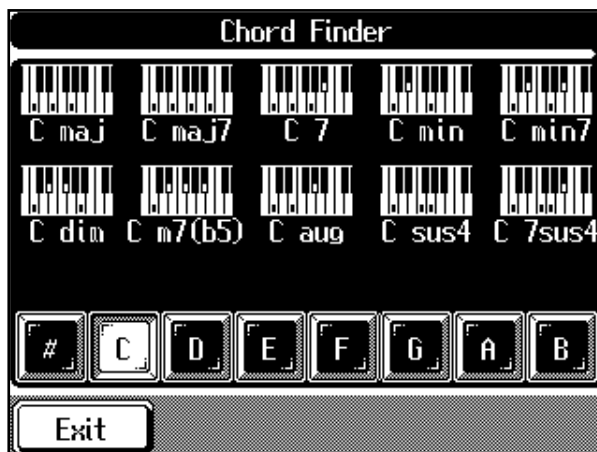

Touch <Exit> to go back to the previous screen.

## Choosing a Music Style

You can choose a wide variety of Music Styles by pressing the Music Style button. The following buttons are called Music Style buttons.



When you press the One Touch Program [Arranger] button to change the Music Style, the played notes and tempo of the right-hand part of the keyboard change to the optimal Music Style, and the settings that let you play with Automatic Accompaniment are made right away.

1. Press the One Touch Program [Arranger] button.
2. Press the Music Style button to choose the group for the Music Style.



3. Press Page <◀> and <▶> and the Touch Screen, the Value [-] [+] buttons, or the dial to choose a Music Style. When you use the Value [-] [+] buttons or the dial, the pages are switched automatically, without having to touch Page <◀> and <▶>.
4. Touch <Preset A>, <B>, <C>, or <D> on the screen. When you choose any one of <Preset A> through <D>, the Music Style's tempo, the tone of the right-hand part, the settings of the Style Orchestrator (p. 78), and the like change. By varying the tempo or Tone, you can enjoy performances with a totally different ambience, even when the Music Style is the same.
5. Touch <Exit> to go back to the Basic screen.
6. Specify a chord by playing it on the left-hand keyboard section. Automatic Accompaniment of the selected Music Style is played.

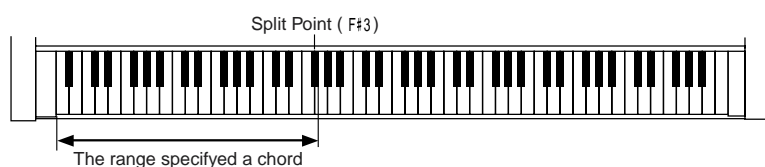

For more information about the types of Music Styles, take a look at the “Music Style List” (p. 175).



For information on the Style Navigator button, take a look at the “Playing with Automatic Accompaniment ([Style Navigator] Button)” (p. 28).



When you change the Music Style, the tempo and Tone change to match the Music Style you've chosen. If you don't want to change the tempo and Tone, take a look at “Keeping the Same Tone and Tempo When the Music Style Changes” (p. 147).



You can change the split point. Please refer to “Changing the Keyboard's Split Point” (p. 145).

7. Press the Intro/Ending [1] or [2] button to play an ending and stop performance of the accompaniment.

## ■ Choosing a Music Style from Data Disk

You can use Music Styles on the Data Disk included with the KF-90, as well as User Styles saved on floppy disk (p. 137).

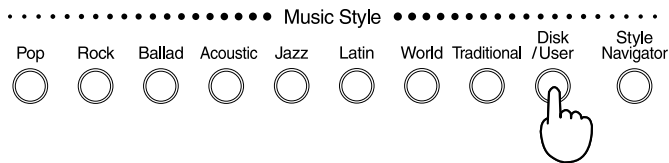

1. Insert the floppy disk into the disk drive.

For information on how to use the disk drive, see p. 39.

2. Press the [Disk/User] button.

The following screen will appear.



3. Touch Page < ◀ > or < ▶ > and the Touch Screen to choose a Music Style.

Touch Page < ◀ > several times to display the Music Styles stored in internal memory.

Styles with numbers that begin with “L” are Styles stored in internal memory.

4. Press the One Touch Program [Arranger] button.

When you specify a chord in the lower section of the keyboard, the music style you’ve chosen will be sounded.

The Music Style you’ve selected from the floppy disk remains in memory until you switch off the power. You can play the Music Style you last selected just by pressing the [Disk/User] button, even if you’ve taken the floppy disk out of the disk drive.



There are some ways how this starting and stopping works. Refer to “Playing a Music Style (Start/Stop)” (p. 74).



You can save three User Styles on the [Disk/User] button (the internal memory) of the KF-90. Take a look at “Saving a User Style” (p. 137).

## Playing Sounds with the Left Hand Along with the Automatic Accompaniment

Ordinarily, when you perform while using the Automatic Accompaniment, no sound is produced from keys in the left part of the keyboard when they are pressed. When you touch the <Lower> icon, though, you can play the tone in the left side of the keyboard while simultaneously having the Automatic Accompaniment play.

**1. Press the One Touch Program [Arranger] button.**

The Basic screen appears.

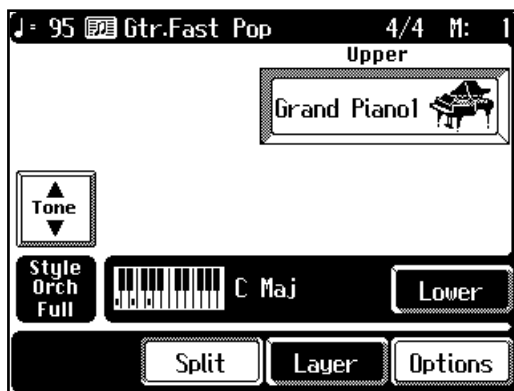

**2. Touch <Lower> on the screen.**

The screen changes as shown below.

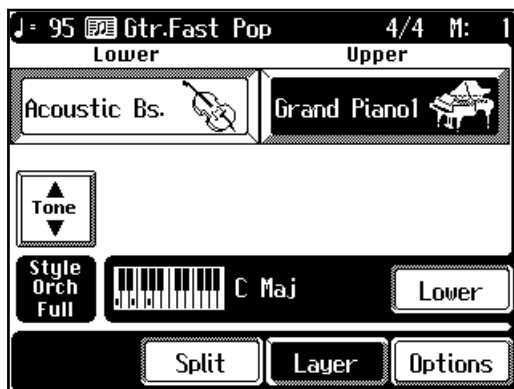

**3. Specify a chord by playing it on the left-hand keyboard section.**

Automatic Accompaniment is played.

**4. To cancel the Lower part sound, touch <Lower>.**

**MEMO**

When changing the tone in the left portion of the keyboard (the lower part), refer to “Changing the Tones” (p. 56).



## Playing Just the Rhythm Pattern

A Music Style can be made to sound only the Rhythm Pattern.

1. **Choose a Music Style.**
2. **Press the One Touch Program [Piano] button.**
3. **Press the [Start/Stop] button.**

Only the Rhythm Pattern of the selected Music Style is played.

### NOTE

There are any patterns in the Music Styles that are not included in the Rhythm Patterns. In certain cases, such as when such Music Styles are selected, the Rhythm Pattern may not play.

## Adjusting the Tempo for Automatic Accompaniment

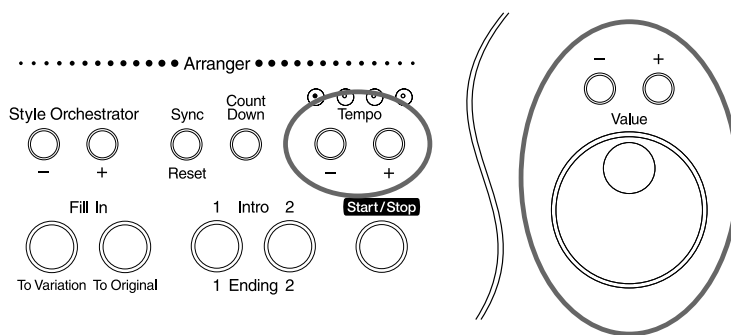

1. **Select the Music Style, then press the One Touch Program [Arranger] button.**

This makes the setting for Automatic Accompaniment.

2. **Use the Tempo [-] and [+] buttons to adjust the tempo.**

The tempo appears at the top-left area of the screen.

Pressing the [+] button makes the tempo faster, and pressing [-] makes the tempo slower.

You can return to the original tempo for the Music Style by pressing [-] and [+] at the same time.

You can also change the tempo using the Value [-] [+] buttons or the dial.



You can change the tempo of Automatic Accompaniment even while the automatic accompaniment is playing.

# Playing a Music Style (Start/Stop)

Pressing the One Touch Program [Arranger] button activates Sync Start for the accompaniment (which starts the accompaniment simultaneously when you play something in the lower section of the keyboard), and makes the setting for automatically playing an appropriate intro for the accompaniment. You can change how this starting and stopping works.

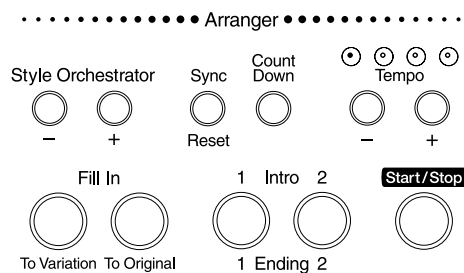

## ■ Starting Automatic Accompaniment When You Play the Left-hand Section (Sync Start)

- 1. Press the [Sync/Reset] button, getting the button indicator to light.**

The Intro/Ending [1] button's indicator will flash.

- 2. Specify the chord on the lower-part of keyboard.**

The intro is played and the automatic accompaniment starts.

### Changing the Intro

Before starting automatic accompaniment, you can follow the steps shown below to change or silence the intro.

#### **Starting Without an Intro**

Press the Intro/Ending [1] button, extinguishing the indicator, then specify the chord.

#### **Starting with a Simple Added Intro**

Press the Intro/Ending [2] button, getting the indicator to start blinking. Then, specify the chord.

## ■ Starting at the Press of a Button

### 1. Press the [Sync/Reset] button, extinguishing the indicator.

The indicator for the Intro/Ending [1] button also goes dark.

### 2. Specify the chord on the lower-part of keyboard.

Fingering a key on the left-hand section of the keyboard while the [Sync/Reset] button's indicator is dark causes a chord to be sounded.

This note is called the "Chord Tone," and the root of the chord that is played at the same time is called the "Bass Tone."

### 3. Press the Intro/Ending [1] or [2] button, or the [Start/Stop] button.

The automatic accompaniment starts.

Pressing the [Start/Stop] button starts the automatic accompaniment without an intro. Pressing the Intro/Ending [2] button plays a simple intro.



You can change the sound of the chord tone and bass tone. Take a look at "Changing the Chord Tone and Bass Tone" (p. 146).

## ■ Stopping Automatic Accompaniment

### Stopping with an Added Ending

#### 1. Press the Intro/Ending [1] or [2] button.

An ending is played, then the automatic accompaniment stops.

Pressing the Intro/Ending [2] button plays a simple ending.

### Stopping at the Press of a Button

#### 1. Press the [Start/Stop] button.

Automatic accompaniment stops as soon as you press the button.

## ■ Adjusting the Timing During a Performance and Starting Over

If the timing of the accompaniment is off during a performance, pressing this button lets you start playing over from the beginning of the division (p. 67).

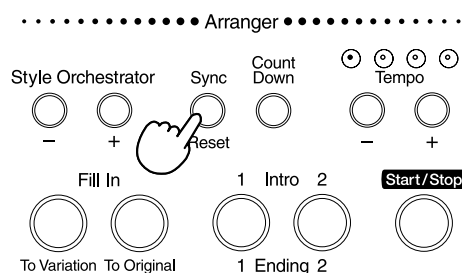

#### 1. Press the [Sync/Reset] button.

The count sound begins immediately, then the accompaniment starts.

## Playing the Count Sound at the End of the Intro

If an intro is played before your performance, you can have the count sound played to the end of the intro, allowing you to understand easily where you are to start playing.

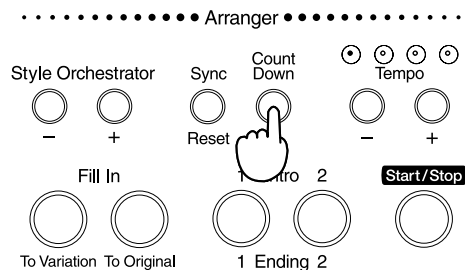

**1. Press the [Count Down] button, getting the indicator to light.**

**2. Press the Intro/Ending [1] or [2] button.**

The intro starts, and the count sound plays to the end of the intro.

If the [Sync/Reset] button's indicator is lit, specifying a chord in the left-hand area will cause the intro to start, and a count to sound in the same way.

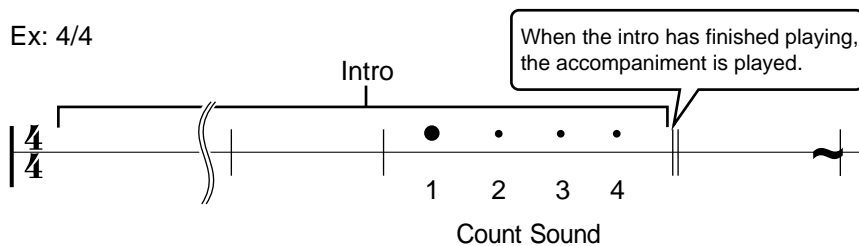

**3. To stop the count sound, press the [Count Down] button, extinguishing its indicator.**

## Modifying an Accompaniment

You can change the arrangement of automatic accompaniment and the accompaniment pattern.

### ■ Changing the Accompaniment Pattern Within a Song (Fill-In)

There are two accompaniment patterns: the original one, and a variation that's a little more flowery. In addition, a fill-in (a short phrase) is added at the points where the accompaniment patterns change, which adds more variation to the song. It can be effective to use the quieter original pattern for the first half of the song, and the variation pattern for the second half.

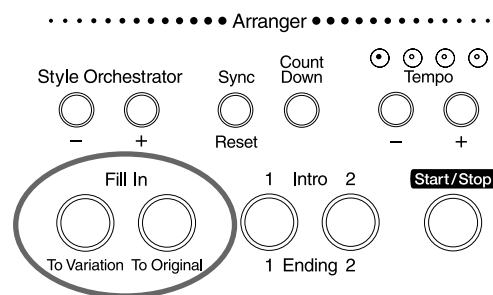

You can change the accompaniment pattern without inserting a fill-in. In that case, assign the function to the pedal and use it. See “Assigning Functions to Pedals” (p. 147).

1. Pressing the Fill In [To Variation] button (its indicator should light) makes the setting for playing the variation accompaniment pattern.
2. Pressing the Fill In [To Original] button (its indicator should light) makes the setting for playing the original accompaniment pattern.

Pressing these buttons during a performance inserts a one-bar fill-in in time with when the buttons were pressed, and the accompaniment pattern changes.

#### What's a “Fill-In”?

A short improvisational phrase inserted at the bar line is called a “Fill-In.” The KF-90 plays the optimal phrase for the selected Music Style.

### Adding a Fill-in Without Changing the Accompaniment Pattern

You can play a fill-in without changing the accompaniment pattern by pressing whichever of the Fill In [To Original] and Fill In [To Variation] buttons that is flashing while a performance is in progress.

### ■ Changing the Arrangement of the Accompaniment

You can change the arrangement of an accompaniment during the performance of automatic accompaniment or while it is stopped. This function is called “Style Orchestrator.” There are four arrangement types of the accompaniment for each Music Style.

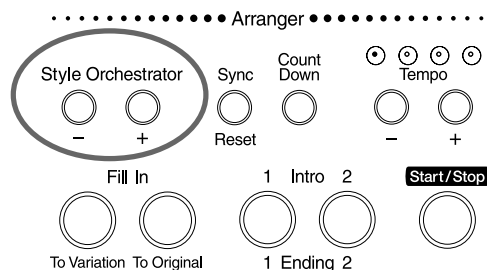

#### 1. Press the Style Orchestrator [-] or [+] button to change the arrangement of the accompaniment.

Pressing the [-] button provides a simpler arrangement; press the [+] button for a more elaborate arrangement.

The value for “Style Orch” in the basic screen changes.

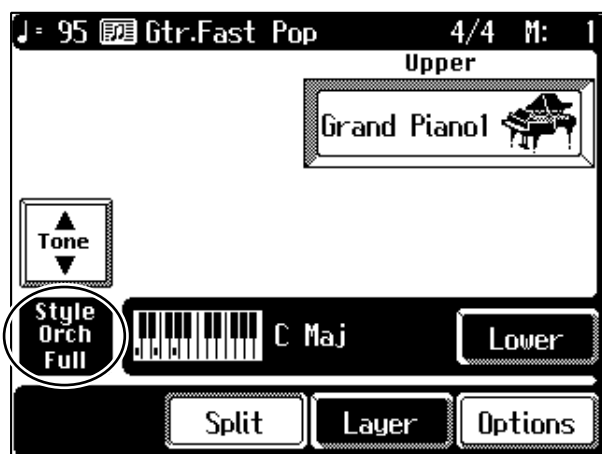

#### NOTE

Some Music Styles don't change the arrangement of the accompaniment when you've followed the steps just described.

Display	Description
<b>Basic</b>	The simplest arrangement
<b>Adv1</b>	A more elaborate arrangement
<b>Adv2</b>	
<b>Full</b>	The most elaborate arrangement

## Adding Harmony to the Right-hand Part (Melody Intelligence)

You can add a harmony to the notes you play with the keyboard.

While an automatic accompaniment is playing, a harmony matched to the chord you designate in the lower section of the keyboard is automatically added to the notes you play on the upper section. This function is called “Melody Intelligence.”

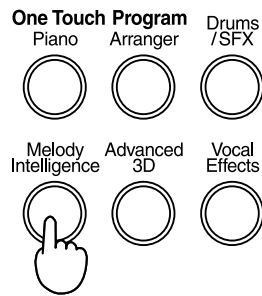

1. Press the [Melody Intelligence] button, getting its indicator to light up.

When you play something on the right-hand section of the keyboard, a harmony is added to the notes you finger.

A Melody Intelligence screen like the one following appears.

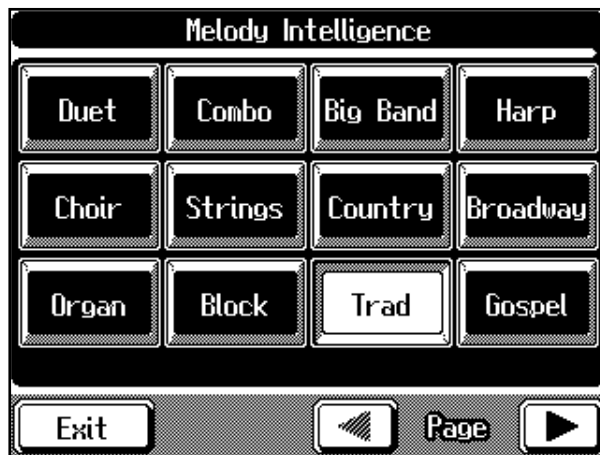

2. Use Page <◀>▶> and the Touch Screen, the Value [-] [+] buttons, or the dial to choose a Harmony type.

When you play something on the keyboard, a harmony of the type you selected is added to the notes you finger.

Touch <Exit> to go back to the previous screen with the Melody Intelligence function still in effect.

3. To cancel the Melody Intelligence function, press the [Melody Intelligence] button to extinguish the indicator.

### NOTE

The different types of harmonies include some that automatically change the Tone. Also, when you finger several keys at the same time, harmony is added to one note.

### Adding Automatic Accompaniment to Regular Piano Performance (Piano Style Arranger)

Usually, with an automatic accompaniment performance, the accompaniment is sounded by the chords you specify on the left-hand section of the keyboard, with the melody played on the right-hand section. If you like, however, you can make the KF-90 recognize chords from the entire keyboard, and perform without splitting the keyboard. This function is called the “Piano Style Arranger.”

This makes it possible to add an accompaniment automatically as you play a song by fingering chords, without giving any thought to the location of a keyboard split.

1. Press the One Touch Program [Arranger] button.
2. Touch <Split> to cancel the Split Play.

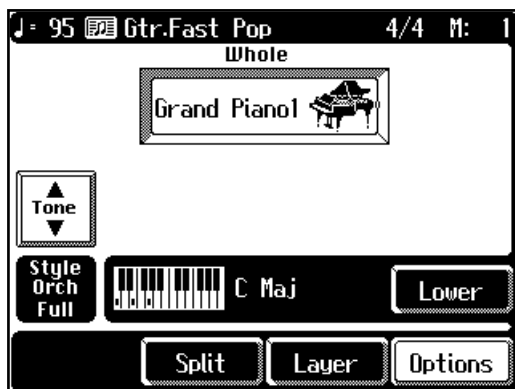

3. Use the Music Style button and Touch screen to choose a Music Style.
4. Touch <Exit> to go back to the Basic screen.
5. Finger the keyboard.

The accompaniment starts when you finger a chord.



## Changing the Volume Balance for the Accompaniment and Keyboard

You can change the volume balance for the song and accompaniment and the notes played from the keyboard.

**NOTE**

When the [Balance] knob is all the way to “Accomp,” no sound is heard when you finger the keyboard. You can usually leave the knob at the center position.

**1. Use the [Balance] knob to change the volume balance.**

Rotating the knob toward “Accomp” lowers the volume of the keyboard.

Rotating the knob toward “Keyboard” lowers the volume of the song.

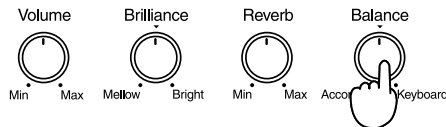

## Adjusting the Volume of Each Performance Part

You can adjust the volume balance of each part of the Music Style and of each tone when playing more than one tone with the keyboard.

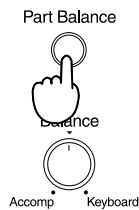

**1. Press the [Part Balance] button.**

The Part Balance screen will appear.

The Part Balance screen is made up of two pages.



This shows the volume balance of each part of the Music Style.

Display	Performance part
<b>Rhythm</b>	Rhythm
<b>Bass</b>	Bass, Bass tone (p. 75)
<b>Accomp</b>	Accompaniment 1, Accompaniment 2, and Accompaniment 3

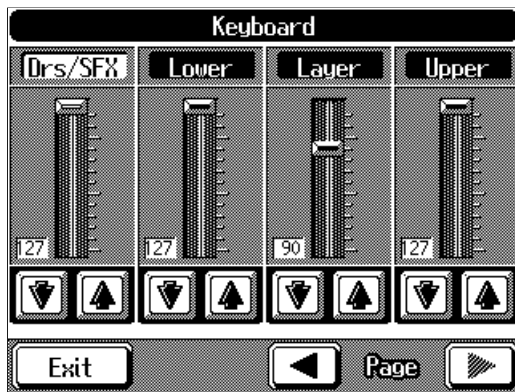

This shows the volume balance of each keyboard tone during Layer play or Split play, or when playing percussion or effect sounds with the keyboard.

<b>Drs/SFX</b>	Volume of percussion instruments/effects played with the keyboard (p. 58).
<b>Lower</b>	Volume level of the Lower Part (p. 55).
<b>Layer</b>	Volume level of the Layer Part (p. 53).
<b>Upper</b>	Volume level of the Upper Part (p. 55).

- 2. Touch   to adjust the volume of the respective Parts.**  
You can adjust the volume by touching the each slider on-screen.

Touch <Exit> to go back to the previous screen.

# Chapter 3 Some Handy Features

## Playing Back Songs for Practice

Let's try practicing along with commercial music files or songs recorded on floppy disk.

You can move to a certain measure within a song, and play back the song from that location.

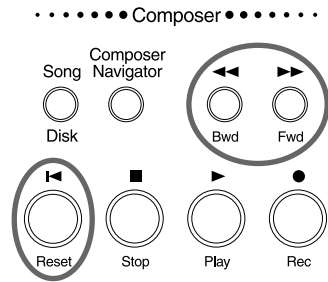

1. Insert the floppy disk into the disk drive (p. 39).
2. Press the [Song/Disk] button.

A Song/Disk screen appears.



3. Touch the screen to choose a song.  
You can also use the Value [-] [+] buttons or the dial to choose a song.
4. Touch <Exit> several times.  
Display the screen where the measure number appears in the top-right area of the screen.
5. Press the Play [▶] button to play back the song.
6. Press the Bwd [◀◀] and Fwd [▶▶] buttons to move to a bar where you want to listen.  
Pressing the button once moves your position by one measure. Hold down the button to move forward or backward continuously.
7. To stop playback of the song, press the Stop [■] button.

### MEMO

If there is song data in the KF-90's internal memory, the "Delete song" message appears. For more information, see "If the following message appears" (p. 99).

### NOTE

When you start playback of Music Files, the measure number on the Basic screen appears in reverse video. While this is in reverse video, the KF-90 is reading data from the floppy disk, so wait a few moments until it finishes.

### To go back to the beginning of the song

1. Press the Reset [ ◀ ] button.

### To move to the end of the song

1. Hold down the Stop [ ■ ] button and press the Fwd [ ▶▶ ] button.

### ■ Displaying the Score

You can have the musical score of a recorded performance or a song from floppy disk be displayed.

When you play back a Music File with lyrics, the lyrics appear on screen.

1. Press the [Song/Disk] button.

The Song/Disk screen appears.

2. Touch the screen to choose a song.

You can also use the Value [-] [+] buttons or the dial to choose a song.

3. Touch <Score> on the screen.

The Score screen appears.

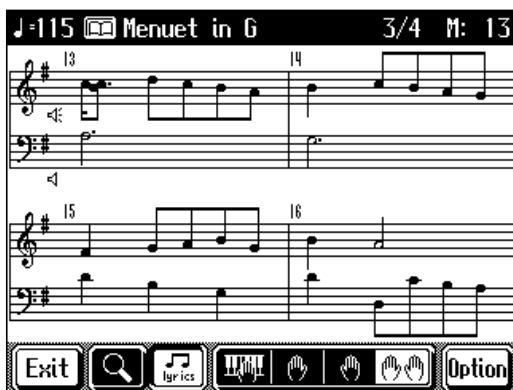

Icon	Description
	The expanded score is displayed.
	Lyrics are displayed on the score.
	Your performance data is displayed.
	The left-hand part is displayed.
	The right-hand part is displayed.
	The both-hands part is displayed on the grand staff.

### NOTE

If you've used markers to designate a passage for repeating (p. 92), you can only move forward and backward within the range specified by the A and B markers.

### MEMO

If touching can't display the lyrics when playing the Music Files containing the lyric data, the setting on the lyric is OFF. Turn ON the setting in the "Hiding the On-screen Lyrics" (p. 153)

### MEMO

No notes appear in the musical score when you select a part that contains no performance data.

Touch to change to another part.

Refer to "Changing the settings for Score screen" (p. 149).

### MEMO

For more information about a part, refer to "Multitrack Recording with 16 Parts (16-Track Sequencer)" (p. 118)

Icon	Description
	You can change the setting of the part displayed or the display setting of the score (p. 149).

#### 4. Press the Play [▶] button.

The song play back starts, and the score moves with the tune.

Touching the illustration of speaker (🔊) on-screen, you can mute the part.

#### Some notes on a Score Screen

- When you start playback of music files, the ⏱ marks appears. While this appears on the score, the KF-90 is reading data from the floppy disk and making the score. Please wait until reading of the data is complete.
- In the Score screen, some lyrics or notes could extend beyond the edges of the screen, and not be displayed.
- The scores that are presented by the display are produced based on the music files. Viewing ease is given priority over precise expression when dealing with complex, high-level music. Because of this, you may find that the score shown in the display does not match what is provided on commercially available sheet music. The score display feature is particularly unsuitable for the display of difficult, complex musical works that demand accurate notation. In addition, the display cannot show notes that are briefer than a sixteenth note.
- If you use the icons on-screen to change the displayed part while the song is playing, the song may be played back from the beginning.

## Adjusting the Tempo

With songs that are difficult to play because their tempo is too rapid, you may find it helpful to first practice the song with the tempo slowed down. Then, after becoming more familiar with the song, you can practice it at a gradually faster tempo.

Changing the tempo has no effect on the pitch of the notes. And you can change the tempo even when the song is in progress.

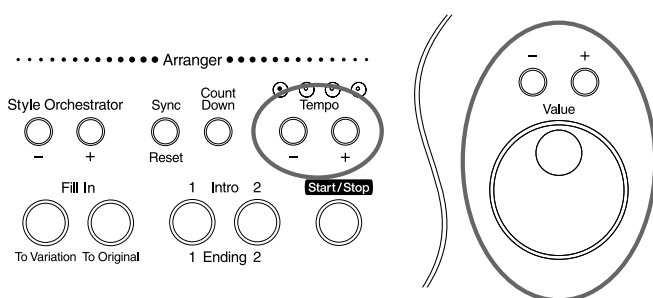

#### Use the Tempo [-] and [+] buttons to adjust the tempo.

- Pressing the [+] button once increases the tempo by one unit. Holding down the button makes the tempo change (speed up) continuously.
- Pressing the [-] button once decreases the tempo by one unit. Holding down the button makes the tempo change (slow down) continuously.
- Press [-] and [+] at the same time to return to the original tempo.

### Adjusting the tempo with the Value [+ ] and [- ] buttons or the dial

When the tempo is displayed at the upper-left area of the screen, you can use the dial to adjust the tempo.

- Turn the dial clockwise to speed up the tempo.
- Turn the dial counterclockwise to make the tempo slower.
- The Value [- ] [+ ] buttons do the same thing as the Tempo [- ] [+ ] buttons.

### ■ Determining the Tempo Using the Selected Interval

You can set the tempo according to the timing with which you tap the screen or the timing at which you count into the microphone. This feature is called “Tap Tempo.” By using the Tap Tempo function, you can quickly set the tempo you are thinking of, without specifying the tempo in numerical terms.

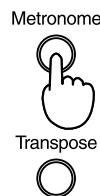

#### 1. Press the [Metronome] button.

The Metronome screen appears.

#### 2. Touch <Tap Tempo>.

The following screen appears.

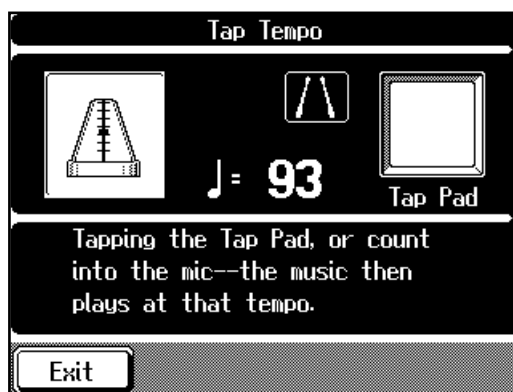

#### 3. Either lightly tap the “Tap Pad” on the screen, or count “1, 2, 3, 4” into the microphone.

The tempo is set to the timing you used when tapping the Tap Pad or counting into the microphone.

Touch <Exit> to go back to the Metronome screen.



When using your voice to set the tempo, be sure to connect a microphone (optional) to the KF-90. For more on connecting a microphone, refer to “Connecting a Microphone” (p. 18).



Tapping the “Tap Pad” too forcefully may damage the Touch Panel. Make sure not to use too much force when tapping the button.



You can count in with the microphone and start the song with the tempo you counted. For details, refer to “Starting Song and Automatic Accompaniment by Vocal Count” (p. 47).

## Playback with No Change in Tempo

If a song has difficult tempo changes, it can be effective to practice the song first at an unchanging tempo. Playback of a song at a steady tempo that doesn't change is called "Tempo Muting."

- 1. Hold down the Stop [■] button and press either the Tempo [-] or [+] button.**
- 2. Press the Play [▶] button.**

Now, songs are played back at an unchanging tempo.

When tempo muting is in effect, the tempo display appears in reverse video.



- 3. To cancel tempo muting, hold down the Stop [■] button and press either the Tempo [-] or [+] button.**

Tempo muting is canceled.

Tempo muting is also canceled if you select another song.

## Counting Down Before a Performance Starts

When you're playing along with a song, you can make sure that your playing is in time with the song by sounding a count before the song starts playing.

This audible count before the playback of a song is called a "Count-In."

**1. Press the [Composer Navigator] button.**

The Composer Navigator screen appears.

**2. Touch <Marker/Count In>.**

The Marker screen appears.

**3. Touch the <Count In> icon.**

With this setting, two measures are counted down before song playback starts.

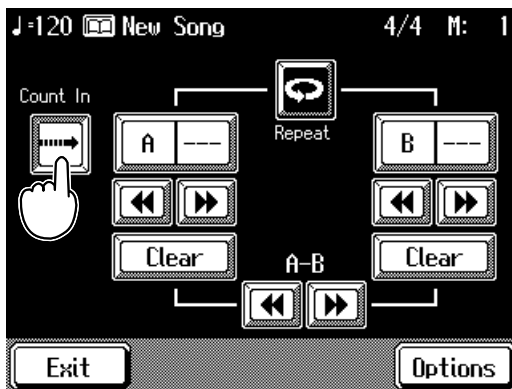

**4. To stop the count-in sound, touch the <Count In> icon.**

Touch <Exit> to go back to the previous screen.



You can change the number of measures counted and the type of sound that you hear. See "Changing the Number of Measures Counted and the Count Sound" (p. 150).



## Preventing the Part to Be Practiced from Sounding

With commercially available music files for piano lessons, you can play back the part for each hand individually. Playing the internal song's right-hand part with your right hand, and the song's left-hand part with your left hand allow you to practice each hand's part separately.

For instance, a music file for piano lessons may be assigned to the five Track buttons as shown below.

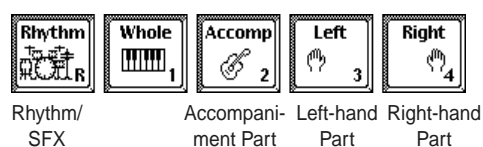

By using these Track Buttons, you can play back with the sound of a specific part removed.

The removal of this specific part's sound is referred to as "muting."

By recording your own performances to the Track Buttons in this fashion, you can mute the parts the same way.

1. Press the [Song/Disk] button to choose the song.
2. Touch <Track> to display the five Track buttons.

The 5 Track buttons screen appears.

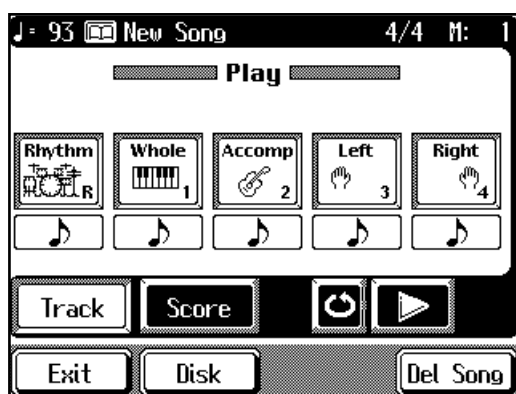

3. Touch the Track button for the part you will play yourself.

The display for the Track button you chose changes to .

The sound of the Track button you chose is muted out.

Touch the same Track button again to cancel muting. You can set and cancel mutes even while songs are being played.

4. Press the Play [▶] button to start playback.

No sound is played from the selected tracks. Practice along with the playback of other Parts.

5. To stop playback, press the Stop [■] button.

### MEMO

To learn more about music files, refer to "Music Files That the KF-90 Can Use" (p. 183).

### MEMO

A Track button has performance data when <  > appears under it.

Track buttons for which < **Empty** > is displayed have no performance data.

### MEMO

If a single Track button includes more than one instrument, and you want to mute out just one of those instruments, take a look at "Changing the Settings of Each Part" (p. 120).

### MEMO

You can change the volume balance for the keyboard and the song. Check out "Changing the Volume Balance for the Accompaniment and Keyboard" (p. 81).

### Placing a Marker Within a Song

By setting markers at points in a song that you want to practice repeatedly, you can then easily move and repeatedly play back the selected measures.

#### ■ Placing/Erasing a Marker Within a Song

You can place two separate markers (Marker A and Marker B) in one song. The marker is placed at the beginning of the bar. Placing markers is a handy way to start playback at the same place as many times as you like.

##### 1. Press the [Composer Navigator] button.

The Composer Navigator screen appears.

##### 2. Touch <Marker/Count In>.

The Marker screen appears.

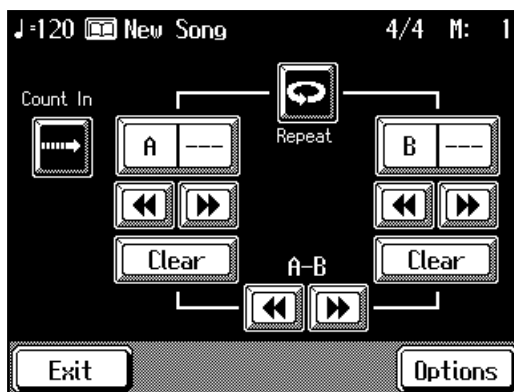

##### 3. Use the Bwd [ <<< ] and Fwd [ >>> ] buttons to move to the bar where you want to place the marker.

The measure number appears in the top-right area of the screen.

##### 4. Touch <---> for Marker <A>.

Marker A is placed at the beginning of the bar you moved to.

<---> in the screen will change to the number of the measure where you placed the marker.

##### 5. In the same way, move a position and touch <---> for Marker <B> to place Marker B.

When you've placed a marker, the number of the measure with the marker appears on screen.

#### Erasing a Marker

##### 1. At the Marker screen, touch <Clear> for the marker you want to erase.

The marker disappears and the on-screen display changes to <--->.



You can also add markers or move to a marker even while playback is in progress.



A marker is normally placed at the beginning of the measure, but you can also place a marker at a position part way through a measure. Take a look at "Placing a Marker in the Middle of a Measure" (p. 150).



You cannot place both marker A and marker B at the same location. Also, you cannot place marker B at a position earlier than marker A.

## ■ Playback from a Marker Location

1. **At the marker screen, touch the measure number of the marker you want to move to.**  
The position from which playback will start is moved to the location where marker A or marker B is set.
2. **Press the Play [▶] button to play back the song from the marker location.**  
You can move to a marker location and continue playback from there by touching measure number for <A> or <B>, even during playback of the song.

## ■ Moving a Marker

You can move a marker that has been placed in a song.  
You can move the entire segment between Marker A and Marker B forward or back, without changing the interval itself.

1. **Touch <◀◀> or <▶▶> to move to where you want to place the marker.**

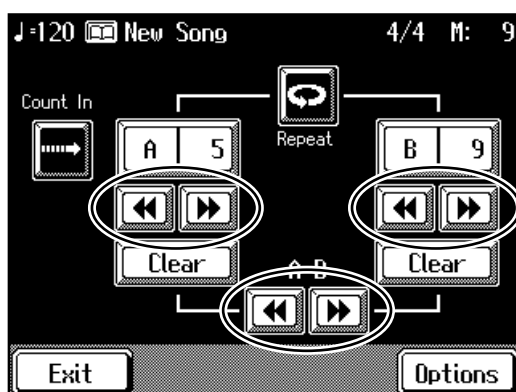

Touch <◀◀> to move toward the beginning of the song.

Touch <▶▶> to move toward the end of the song.

### Moving <A-B>

As an example, let's suppose that marker A is at the start of the fifth measure and marker B is at the start of the ninth measure.

- Touch <◀◀> to shift marker A to the beginning of the first measure and marker B to the beginning of the fifth measure.



- Touch <▶▶> to shift marker A to the beginning of the ninth measure and marker B to the beginning of the thirteenth measure.

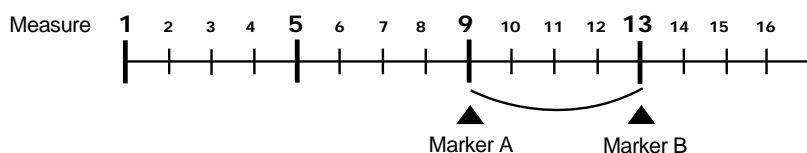

## Playing Back to the Same Passage Over and Over

You can play back a particular passage repeatedly. This is convenient when you want to practice the same passage a number of times.

**1. Press the [Composer Navigator] button.**

The Composer Navigator screen appears.

**2. Touch <Marker/Count In>.**

The Marker screen appears.

**3. Place markers A and B to enclose the passage you want to repeat.**

For instance, suppose you want to play back the passage from the fifth through eighth measures over and over. You should place marker A in the fifth bar and marker B in the ninth bar.

**4. Touch the <Repeat> icon.**

The setting is made for repeated playback of the passage from marker A to marker B.

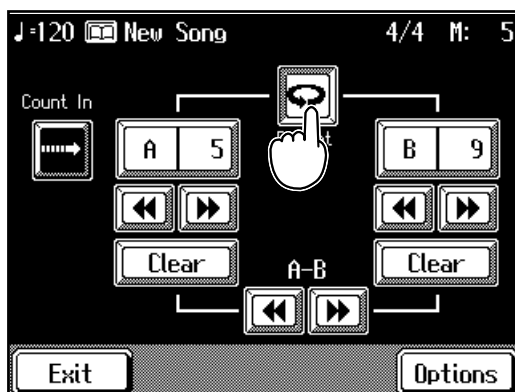

**5. Press the Play [▶] button.**

The passage from marker A to marker B is played repeatedly.

- If you don't place any markers, playback repeats from the beginning to the end of the song.
- If you only place marker A, playback repeats from marker A to the end of the song.
- If you only place marker B, playback repeats from the beginning of the song to marker B.

**6. Press the Stop [■] button to stop playback of the song.**

To cancel the setting for repeated playback, touch the <Repeat> icon in the Marker screen.

Touch <Exit> to go back to the Composer Navigator screen.



For more info about placing markers, refer to 90 pages.

## Transposing the Key of the Keyboard (Key Transpose)

You can transpose the key of a performance without having to shift the position of your fingers on the keyboard. This feature is called “Key Transpose.”

In situations such as when providing accompaniment to a song, using the Key Transpose function to match the singer’s vocal register lets you easily transpose the sounds without changing the score.

Transpose



### 1. Press the [Transpose] button.

A Transpose screen like the one below appears.

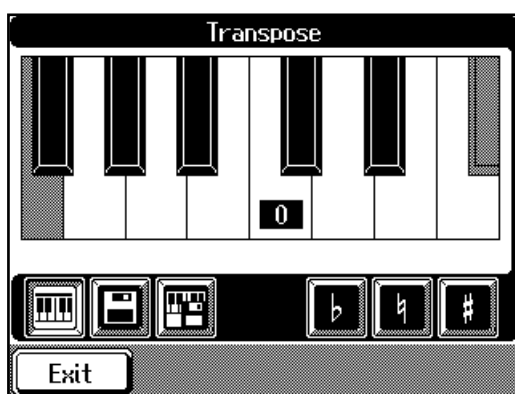

### 2. Touch .

The notes you play with the keyboard are transposed.

### 3. Choose the value for transposition by touching or on the screen.

Each touch of  or  transposes the key by a semitone.

You can also change the transpose value using the Value [-] [+] buttons or the dial.

The setting range is from -6 to 0 to +5.

The [Transpose] button’s indicator goes off when the value is “0.”

### 4. Touch to return the keyboard transposition to the original key.

The [Transpose] button’s indicator then goes out.

Touch <Exit> to go back to the previous screen.

#### NOTE

The transposition setting returns to its original value when switch off the power or choose another song.

### <Example>

In this example, we'll consider the C note in the key of C major to be the basic note. Counting from the tonic to the major third of C (E), there are four keys, including the black keys, so set the value to "+4."

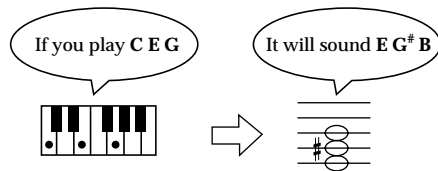

## Transposing a song for playback

You can transpose a song for playback.

When using your own recorded performances or songs from music data while playing ensemble with another instrument, you can easily transpose the playback pitch to match the pitch of the other instrument.

### 1. Press the [Transpose] button.

The Transpose screen appears.

### 2. Touch .

### 3. Choose the value for transposition by touching or on the screen.

Each press of  or  transposes the key by a semitone.

You can also change the transpose value using the Value [-] [+] buttons or the dial.

You can transpose the song within a range of -24 to 24 semitones.

### 4. Touch to return the song transposition to the original key.

Touch <Exit> to go back to the previous screen.

## Transposing Both the Keyboard Notes and the Song

### 1. At the Transpose screen, touch .

Both the sounds played with the keyboard and the those in the song being played back are transposed.

The setting range at this time is from -6 to 0 to +5.

### NOTE

The transposition setting returns to its original value when switch off the power or choose another song.

## Checking Your Performance On Screen

You can play back a Music Files song or a previously recorded model song and compare your own performance with the screen as you play back the song.

### 1. Press the [Function] button.

The Function screen appears.

### 2. Touch <Piano Partner>.

A Keyboard screen or Graph screen like the one shown below is displayed.

You can switch between the two screens by touching <Graph> or <Keyboard> at the bottom of the screen.

With either screen, the upper portion shows the playback of the song, and the lower portion shows what's played on the keyboard.

#### The Keyboard Screen

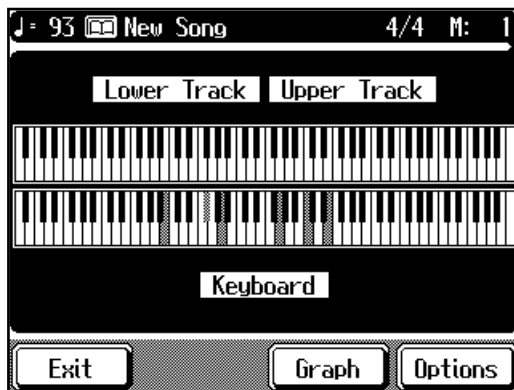

When this screen is visible, you can check the pitch.

The key for the note being played is indicated.

#### The Graph Screen



When this screen is visible, you can check a note's velocity and length.

The height shows the note's velocity, and the width shows the note's length.

### 3. Play back the song, and try playing along with it.

Now let's check your performance on the screen.

Touch <Exit> to go back to the Function screen.

#### NOTE

If the upper screen doesn't change when you play back a song, the part settings displayed in the upper screen do not match. Take a look at "Specifying the Part to Display" (p. 96) and make the settings for the part to display.

### ■ Specifying the Part to Display

You can display a different Part of the model song.

1. At the Keyboard screen or the Graph screen, touch <Options>.

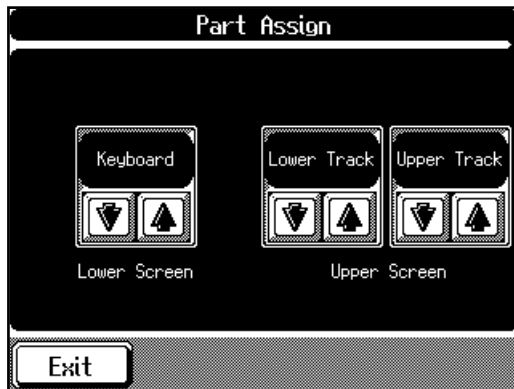

2. Touch   to switch the Part that's displayed.

Setting	Value
Lower Screen	Keyboard, Whole Track, Parts 1–16, OFF
Upper Screen (Left)	Lower Track, Parts 1–16, OFF
Upper Screen (Right)	Upper Track, Parts 1–16, OFF

The upper display can show two parts simultaneously.

When the power is turned on, this is set to display the “Lower Track” and “Upper Track” simultaneously, but you may select parts 1–16 as necessary.

When <Keyboard> is selected in the Lower Screen, the keyboard performance appears.

After recording your performance, if you want to compare it with the model performance again, all you have to do is to choose the part where you recorded your performance.

3. When you're done making the settings, touch <Exit>.

You are returned to the previous screen.







For more information about Parts, refer to “Multitrack Recording with 16 Parts (16-Track Sequencer)” (p. 118).



# Chapter 4 Recording and Saving the Performance

## What is a Track Button?

A recorded performance is automatically assigned to 5 Track buttons. The Track buttons appear in the display whenever a performance is being recorded or played back.

Track button name	Performance recorded
	The Rhythm Part of an Automatic Accompaniment is recorded here. When a Tone set such as a drum set or an SFX set has been chosen (p. 58), it is also recorded here.
	The performance of the entire keyboard is recorded. Performances without Automatic Accompaniment are normally recorded here. Layer Part (p. 53) is also recorded here. When the Piano Style Arranger is active (p. 80), your performance is recorded here.
	The Bass Part of an Automatic Accompaniment and the Accompaniment Part are recorded here.
	With Automatic Accompaniment set to play along with the sounds you play in the left part of the keyboard (p. 72), your own performance with the left hand is recorded. When you're using split play (p. 55), the left-hand part is recorded.
	When you're using split play (p. 55) or Automatic Accompaniment (p. 70), the right-hand part is recorded.



## Displaying the Track buttons

Track buttons appear on the touch panel when needed, and let you perform a wide variety of operations such as recording and playing back performances.

**To display the Track buttons, press the [Song/Disk] button, and touch <Track> on the Song/Disk screen.**

With songs in the KF-90's internal memory, the Track buttons are shown when the Rec [●] button is pressed.



A Track button has performance data when  appears under it. Track buttons for which  is displayed have no performance data.

## Recording Your Playing with Ease

This records only what you play on the keyboard, without using Automatic Accompaniment.

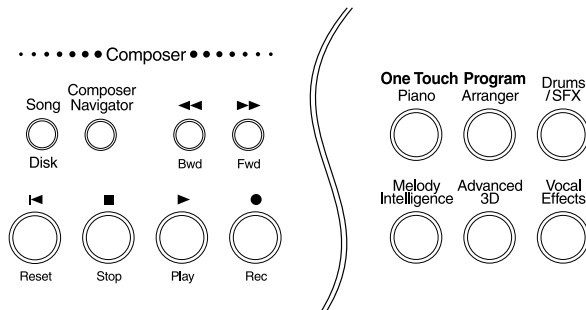

**1. Press the [Song/Disk] button.**

A Song/Disk screen like the one following appears.



**2. Touch <0:> to display <0:New Song> on the screen.**

If <0: > doesn't appear on screen, touch Page < ◀▶ ▶ > to switch screens.

**3. Press the One Touch Program [Piano] button.**

**4. Decide on the tone, tempo, and beat of the performance.**

Use the Tone Select buttons and the touch screen to choose the tone. If necessary, press the [Metronome] button to play the metronome.

**5. Press the Rec [ ● ] button.**

The Play [ ▶ ] button indicator will flash, and the KF-90 will be ready for recording.

To cancel recording, press the Stop [ ■ ] button.

**6. Press the Play [ ▶ ] button to start recording.**

A two-bar count-in sounds, then recording starts.

Recording will begin when you start playing the keyboard, even if you do not press the Play [ ▶ ] button. In this case, the count will not be heard.

The Rec [ ● ] button and Play [ ▶ ] button indicators will light.

**7. Press the Stop [ ■ ] button when your recording is completed.**



To record a performance using Automatic Accompaniment, see “Recording a Performance Using Automatic Accompaniment” (p. 100).



If there is song data in the KF-90's internal memory, the “Delete song” message appears. For more information, see “If the following message appears” (p. 99).



For an explanation of how to select the tempo and the beat, refer to p. 63.

**Listening to the Recorded Songs**

Play back the recorded performance.

- 1. Press the Reset [ ⏮ ] button.**  
Now you can play back the song from the beginning.
- 2. Press the Play [ ▶ ] button.**  
The recorded performance is played back.
- 3. To stop playback, press the Stop [ ■ ] button.**

**If the following message appears**

If you've recorded a tune, the following message appears on the screen when you try to choose another song.

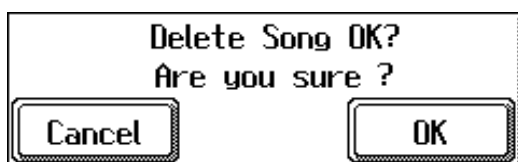

- **If you don't want to erase the song**

Touch <Cancel>.

Save the song on a floppy disk.

For information on how to save your song, see "Saving Songs to Floppy Disks" (p. 109).

- **Erasing a song**

Touch <OK>.

The recorded performance or song whose settings have been changed is erased.

**NOTE**

Any performance that has been recorded is deleted when the power to the KF-90 is turned off. If you don't want to lose your recorded performance, save it on a floppy disk. For information on how to save your song, see "Saving Songs to Floppy Disks" (p. 109).

**NOTE**

Until a recorded performance is erased, you can't listen to other tunes. Check out "Erasing a Recorded Song" (p. 102).

## Recording a Performance Using Automatic Accompaniment

You can record the performance with Automatic Accompaniment easily.  
A recorded performance is automatically assigned to Track buttons.

**1. Press the [Song/Disk] button.**

A Song/Disk screen like the one shown below appears.



**2. Touch <0:> to display <0:New Song> on the screen.**

If <0: > doesn't appear on screen, touch Page < ◀ > ▶ > to switch screens.  
You can also choose it using the Value [-] [+] buttons or the dial.

**3. Press the One Touch Program [Arranger] button.**

This makes the setting for Automatic Accompaniment.

**4. Use the Music Style buttons and the Touch Screen to choose a Music Style.**

**5. Touch <Exit> to go back to the Basic screen.**

**6. Use the Tempo [-] and [+] buttons or the dial to adjust the tempo of the accompaniment.**

**7. Press the Rec [ ● ] button.**

The Play [ ▶ ] button indicator will blink, and the KF-90 will be ready for recording.

To stop recording, press the Stop [ ■ ] button.

**8. Specify a chord by playing it in the lower section of the keyboard to begin recording.**

Automatic accompaniment starts, and recording is started at the same time.

**9. To stop recording, press the Intro/Ending [1] or [2] button.**

An ending is played, then the automatic accompaniment stops, and recording is stopped at the same time.

Press the [Start/Stop] button to stop the accompaniment and recording without ending.

Let's follow the procedure described in "Listening to the Recorded Songs" (p. 99) and listen the recorded performance.



If there is song data in the KF-90's internal memory, the "Delete song" message appears. For more information, see "If the following message appears" (p. 99).



You can start recording by pressing the Play [ ▶ ] button.



You can change how recording is stopped when recording a performance with Automatic Accompaniment. To learn how, see "Changing How Recording Stops" (p. 103).

## Redoing a Recording

Redoing a recording involves specifying a Track button you want to record over and then recording over again.

When you select a Track button and record over a track that has already been recorded, the newly recorded performance occupies a position extending from the location where you started recording to where you stopped recording.

### 1. Using the Bwd [ ◀◀ ] and Fwd [ ▶▶ ] buttons, move to the measure where you wish to start recording.

Press the Reset [ ◀ ] button at the beginning of the song.

### 2. Press the Rec [ ● ] button.

The Rec [ ● ] button's indicator lights up.

The 5 Track screen appears.

To stop recording, press the Stop [ ■ ] button.

### 3. Touch the Track button for the track you want to record over.

< Standby > will appear above the selected Track button.

The Rec [ ● ] button and Play [ ▶ ] button indicators will flash, and the KF-90 will be ready for recording.



### 4. Begin recording.

If you redo a recording with Automatic Accompaniment, specify a chord in the left-hand section of the keyboard, or press the [Start/Stop] button.

If you don't use automatic accompaniment, press the [Sync/Reset] button to extinguish the indicator, and then press the Play [ ▶ ] button.

The mark < Standby > changes < Rec >.

### 5. To stop recording, press the Stop [ ■ ] button.

To record the ending over again, press the Intro/Ending [1] or [2] button.



If you want to erase a previous performance before recording over it, take a look at "Erasing the Sound Recorded at Specific Track Buttons" (p. 102).



With songs in the KF-90's internal memory, the Track buttons are shown when the Rec [ ● ] button is pressed.

For information on the Track buttons, take a look at "What is a Track Button?" (p. 97).



The song's tempo is determined when the song is first recorded. Even when each track is recorded over with the tempo changed, the song is played back at the tempo selected when the song was first recorded. To change the tempo of a song that has already been recorded, refer to "Changing a Song's Basic Tempo" (p. 122).

# Erasing a Recorded Song

You can erase a song that's been recorded.

### Erasing using the buttons

1. **Hold down the [Song/Disk] button and press the Rec [ ● ] button.**

The following screen appears.

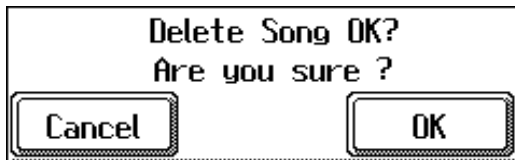

2. **Touch <OK> to erase the recorded song.**

If you touch <Cancel>, the recorded tune is not erased.

### Erasing at the 5 Track Screen

1. **Display the 5 Track Screen.**

To display the screen, press the [Song/Disk] button, then touch <Track> (p. 97).

2. **Touch <Del Song> at the bottom of the screen.**

The confirmation screen appears.

3. **Touch <OK> to delete the song.**

If you touch <Cancel>, the song is not erased.

### ■ Erasing the Sound Recorded at Specific Track Buttons

Here's how to erase what's been recorded to a particular Track button:

1. **Press the [Song/Disk] button.**

The Song/Disk screen appears.

2. **Touch <Track> on the screen to display the Track buttons.**

A Track button has performance data when <  > appears under it.

Track buttons for which <  > is displayed have no performance data.

3. **While touching the Track button where the sound you want to erase on the Touch Screen, press the Rec [ ● ] button.**

The recorded performance is deleted.

The displayed Track button changes to <  >.

#### NOTE

You can't erase the settings for the recorded song's basic tempo or beat.

## Changing How Recording Stops

You can change how recording is stopped when recording a performance using Automatic Accompaniment.

1. Press the [Composer Navigator] button, getting its indicator to light up.

The Composer Navigator screen appears.

2. Touch <Rec. Mode>.

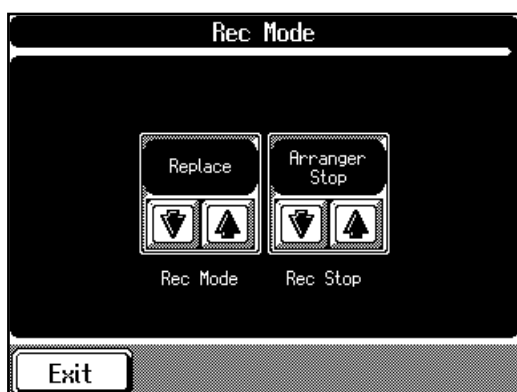

3. Touch <Rec Stop>   to switch between “Arranger Stop” and “Composer Stop.”

Indication	Description
<b>Arranger Stop</b>	When Automatic Accompaniment stops, recording also stops at the same time.
<b>Composer Stop</b>	Recording doesn't end when Automatic Accompaniment stops. Press the Stop [ ■ ] button to stop recording.

Touch <Exit> several times to go back to the previous screen.

## Recording Songs Starting with Pickups

You can record songs that start with pickups. Songs that begin on a beat other than the downbeat are called “songs with pickups.”

**1. Press the [Song/Disk] button.**

**2. Touch <0: > to display <0: New Song>.**

If <0: > doesn't appear on screen, touch Page < ◀ > and < ▶ > to switch screens.

**3. Touch <Exit> several times.**

Display the screen where the measure number appears in the top-right area of the screen.

**4. Press the Rec [ ● ] button, turning on that button's indicator.**

The KF-90 enters standby for recording.

**5. Press the Bwd [ ◀◀ ] button once.**

The measure number at the top-right area of the screen changes to “PU” (pickup).

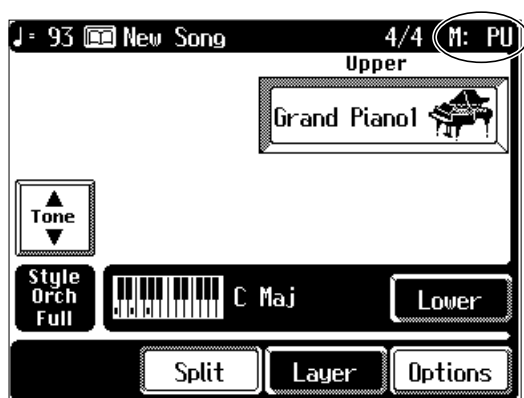

**6. Press the Play [ ▶ ] button to start recording.**

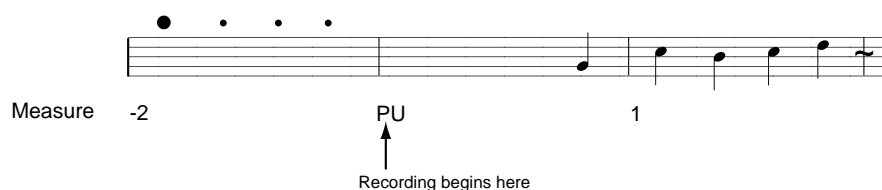

**7. Press the Stop [ ■ ] button to stop recording.**

### MEMO

If there is song data in the KF-90's internal memory, the “Delete song” message appears. For more information, see “If the following message appears” (p. 99).



## Composing an Accompaniment By Entering Chords (Chord Sequencer)

You can enter its chord progression, the places where the accompaniment pattern changes, and so on to create an accompaniment for the song. This feature is called “Chord Sequencer.”

With chord sequencer, you can create an accompaniment ahead of time and play along with this accompaniment using just your right hand. This makes it easier to enjoy automatic accompaniment.

Creating an accompaniment with Chord Sequencer is carried out at the Chord Sequencer screen.

### 1. Press the [Composer Navigator] button, getting its indicator to light up.

The Composer Navigator screen appears.

### 2. Touch <Chord Sequencer>.

The screen like the one shown below is called “Chord Sequencer screen.”

This is the “cursor.” The cursor shows where the chord change or other information is input.

This indicates the position where the accompaniment pattern (Division) or the Style Orchestrator changes.

This is the end of the song. When continuing to add input, insert measures by touching <Ins>.

	One measure is inserted after the measure indicated by the cursor.
	This deletes the measure indicated by the cursor.
	In the Chord Selector screen, specify the chord. Refer to “Inputting Chords Without Playing the Keyboard” (p. 107)
	Erase all of the data that has been input.
	This clears the settings in the place where the cursor is positioned.
	This records the accompaniment you have composed. Touch here when you have finished creating all your input

3. Use the Music Style buttons and the touch screen to choose a Music Style.
4. Touch <Exit>. You are returned to the Chord Sequencer screen.
5. Enter the chord progression and the accompaniment pattern.

### Inputting Chords with the Chord Sequencer

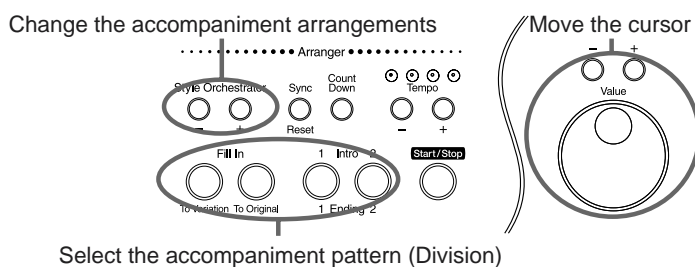

Select the accompaniment pattern (Division)

1. Use the Value [+/-] buttons or the dial to move the cursor to where you want to make an insertion.  
Use the Bwd [◀] and Fwd [▶] buttons to move the cursor a bar at a time.
2. Enter the chord progression and the changes in the accompaniment pattern and arrangement.  
Just as when performing with Automatic Accompaniment, press the keys to specify a chord, and press a button to select the accompaniment pattern (p. 77). You can change the accompaniment arrangements with the Style Orchestrator [-] and [+] buttons (p. 78).
3. Touching <Ins> once inserts a measure after the bar where the cursor is located. Conversely, touching <Del> deletes the measure containing the cursor and moves the cursor to the next bar.

### Check the Accompaniment You Inputted

Let's listen to the completed accompaniment while inputting data.

1. Press the Play [▶] button to play back the accompaniment.
2. Press the Stop [■] button to stop playback.

## 6. When you have finished inputting all the data, touch <Execute>.

The accompaniment you've composed is registered at "0:New Song." Press the Play [▶] button and try fingering the melody while the accompaniment you've composed is played back.

### MEMO

Pressing the [To Variation] button or the [To Original] button adds a fill-in at the cursor position and a Variation or Original Division at the measure after the fill-in. If you want to enter a Variation or Original Division without inserting a fill-in, you need to assign the function to the pedal. See "Assigning Functions to Pedals" (p. 147).

### MEMO

To insert fractional chords such as Fm/C, assign the "Leading Bass function" to a Pad button or a pedal. See "Assigning Functions to Pedals" (p. 147).

### MEMO

You can only insert an intro at the beginning of a song. When you add an intro, the number of bars corresponding to the length of the intro is inserted automatically.

### MEMO

If you assign the function to a pedal, you can insert a break in the middle of a song. See "Assigning Functions to Pedals" (p. 147).

### MEMO

The song you've created disappears when you turn off the power. If you don't want to lose it, you should save it on a floppy disk. Take a look at "Saving Songs to Floppy Disks" (p. 109).

## Inputting Chords Without Playing the Keyboard

You can use <Chord> at the bottom of the Chord Sequencer screen to specify chords on the screen.

### 1. At the Chord Sequencer screen, touch <Chord>.

The following screen will appear.

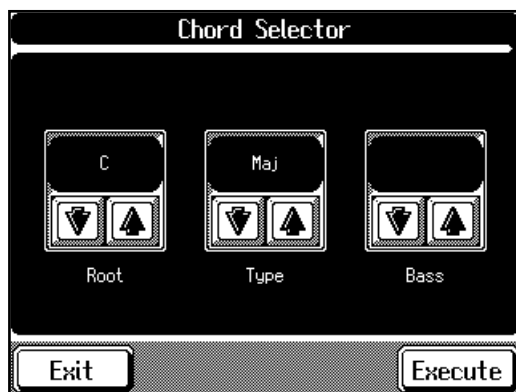

### 2. Touch the to specify a chord.

Touch <Exit> to return the Chord Sequencer Screen.

### 3. Touch <Execute> to enter the chord.

You are returned to the Chord Sequencer screen.

# Creating a Rhythm Part with Ease

The KF-90 has a large number of onboard rhythm patterns. You can use these onboard rhythm patterns to create a rhythm part with ease.

### 1. Press the [Composer Navigator] button, getting its indicator to light up.

The Composer Navigator screen appears.

### 2. Touch <Rhythm Pattern>.

The following screen will appear.



Touch <Exit> to go back to the previous screen.

### 3. Use the touch screen to choose a rhythm pattern.

You can use the Value [-] [+] buttons or the dial.

Rhythm patterns are shown in the format “name (number of bars).”

### 4. Touch <Audition> on screen to hear the rhythm pattern.

Make sure the rhythm pattern you hear is the one you chose.

To stop the rhythm pattern, touch <Stop> on the screen.

### 5. Touch <Record> on the screen to start recording.

The rhythm pattern begins to play, and at the same time, recording starts.

Record rhythm patterns only for the necessary number of measures.

### 6. Touch <Stop> on the screen to stop recording.

The rhythm pattern stops, and recording ends.



The rhythm pattern is recorded to the <R/Rhythm> Track button. When using the 16-track sequencer (p. 118), you can record only to Part D (10).



For more information about onboard rhythm patterns, please refer to “Rhythm Pattern List” (p. 177).



You can also paste a rhythm pattern into a song without recording anything. Take a look at “Copying a Rhythm Pattern” (p. 126).

## Saving Songs to Floppy Disks

The performance data recorded in the KF-90's internal memory will be lost when you switch to another song or when the power is turned off.

Be sure to save unfinished performance data as well as other important performance data to a floppy disk.

### ■ Formatting Floppy Disks (Format)

New floppy disks or disks that have been used on another device cannot be used with the KF-90 just as they are. The operation that readies floppy disks for use with the KF-90 is called "Format."

#### Caution!

Formatting a disk destroys all data previously stored on the disk. If you're formatting a used floppy disk for reuse, be sure to check first to make sure the disk doesn't contain any data you don't want to lose.

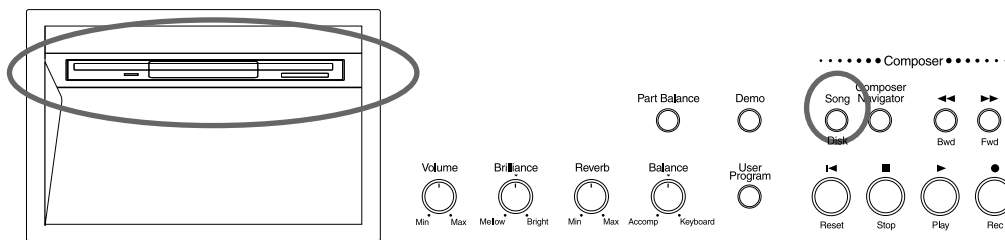

#### NOTE

If you're using the disk drive for the first time, be sure to read the important notes on p. 6.

### 1. Press the [Song/Disk] button.

A Song/Disk screen like the one following appears.



### 2. Touch <Disk> on the screen.

A Song Disk Menu screen like the one shown below appears.



### 3. Make sure the write-protect tab on the floppy disk is positioned at "WRITE" (write enabled).

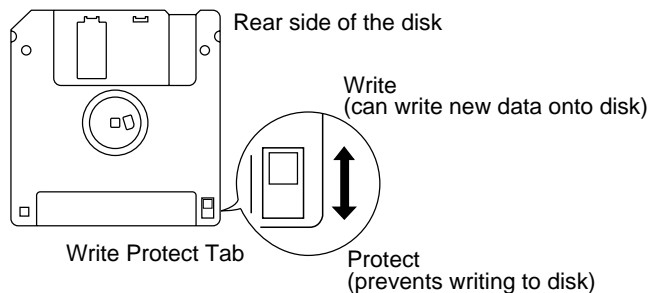

### 4. With the label of the floppy disk facing upward, insert it into the disk drive until it clicks into position.

### 5. Touch <Format Disk>.

The following screen appears.



Touch <Cancel> to go back to the Song Disk Menu screen.

### 6. Touch <OK> to start formatting.

When the format is finished, the Song Disk Menu screen returns.

Touch <Exit> several times to go back to the previous screen.

#### NOTE

Never eject a disk while reading or writing is in progress, since that can damage the magnetic surface of the disk, rendering it unusable. (The disk drive's indicator will light up at full brightness when the drive is busy reading or writing data. Ordinarily, the indicator will be less brightly lighted, or be extinguished.)

#### NOTE

Don't try to take the floppy disk out of the disk drive until the formatting process is finished.

#### MEMO

If "Error" appears on screen, take a look at "If this Message Appears on Screen" (p. 164).

## ■ Saving Your Songs on Floppy Disk

A recorded performance is discarded when you switch off the power, or choose another song. The process of storing data such as recorded performances on floppy disk is called “saving.” It’s a good idea to store important songs on floppy disk.

Before using a new floppy disk or a floppy disk used on another device, it must be formatted on the KF-90. Take a look at “Formatting Floppy Disks (Format)” (p. 109).

### 1. Make sure the write-protect tab on the floppy disk is positioned at “WRITE” (write enabled).

For details, refer to p. 110.

### 2. With the label of the floppy disk facing upward, insert it into the disk drive until it clicks into position.

### 3. Press the [Song/Disk] button.

A Song/Disk screen appears.

### 4. Touch <Disk> on the screen.

A Song Disk Menu screen appears.

### 5. Touch <Save>.

The following screen will appear.

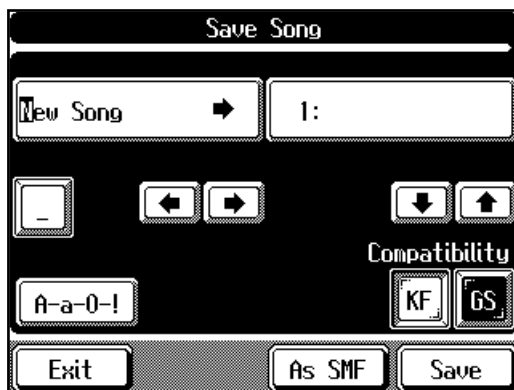

Touch <Exit> to go back to the Song Disk Menu screen.

### 6. Touch to scroll the cursor sideways, and enter the name of the song by using the Value [-] [+] buttons or the dial to choose the letters.

Assign a name to the song to be saved.

Touch <A-a-0-!> at the bottom of the screen to change the type of script.

Each touch of <A-a-0-!> cycles the type of characters through “English (upper case),” “English (lower case),” “numerals,” “symbols,” then back to “English (upper case).”

Touching <\_> inserts a blank space at the cursor location.

#### NOTE

Depending on the playback instrument, some notes may drop out or sound different.

#### NOTE

Some commercially available music files cannot be saved because they are copyrighted.

#### MEMO

If not handled with care, a floppy disk can get cracked, or the data on it can get corrupted, making playback impossible. We recommend saving your songs on two different floppy disks. By putting away for safekeeping an additional copy of a floppy disk on which your songs are saved, you can feel safer.

#### NOTE

Inserting a floppy disk containing one or more saved songs into another device (such as a computer) with the floppy disk’s protect tab left in the “write” position may, depending on the device, render the songs on that floppy disk permanently unplayable (refer to the cautions on p. 6).

### 7. After you've entered the name of the song, touch to choose a song number.

When you select a song number that is already being used for another song, the name of the song appears in the save destination column. If you then proceed to save the new material to that song, the song previously saved in that destination is erased, and the new song is saved in its place. If you don't want to erase a previously saved song, choose a number where no song name appears in the destination column.

### 8. Touch Compatibility <KF> or <GS>.

The KF-90 feature specially created tones, exclusive to the KF-90, which provide richer, more realistic musical expression on these instruments. However, song data recorded using these tones may not be reproduced correctly when played back on other instruments. If you want to save your data so that it can be played back on other GS (p. 183) devices, save the data with Compatibility "GS" enabled.

Indication	Description
<b>KF</b>	Saves the data using sounds exclusive to the KF-90, for rich, expressive performances.
<b>GS</b>	Saves the data in a form that allows you to enjoy play-back on other GS devices.

### 9. Touch <Save> or <As SMF> to start saving.

There is a difference described below between <Save> and <As SMF> in format for saving.

Indication	Description
<b>Save</b>	Saves the song in KF-90 format. You can listen to songs saved in this format on the Roland HP-G series and KR series keyboards as well as on Roland MT series devices. This format is called "i-format".
<b>As SMF</b>	Saves the song as a SMF (Standard MIDI File). Songs saved in this SMF format can be listened to on many instruments that can play SMF music files (p. 183).

Saving may take from several second, to several dozen seconds.

When the saving process is finished, the Song Disk Menu screen appears.

Touch <Exit> to go back to the previous screen.



If the Compatibility function is "GS" when you save the data, the performance may differ slightly from the original recording when played back on the KF-90.



You can only save songs in one format on a single floppy disk. And a song recorded using commercial music files can't be saved in "Save As SMF" format for reasons of copyright protection.



Don't take the floppy disk out of the disk drive until the saving process is finished.



It's a good idea to get into the habit of moving the write-protect tab on the floppy disk to the "Protect" position when you've finished saving your data. Keeping the tab at "Protect" prevents operations that could erase your songs by mistake.





## Deleting Songs from Floppy Disks

You can delete songs that have been saved to floppy disks.

- 1. Make sure the write-protect tab on the floppy disk is positioned at “WRITE” (write enabled).**  
For details, refer to p. 110.
- 2. With the label of the floppy disk facing upward, insert it into the disk drive until it clicks into position.**
- 3. Press the [Song/Disk] button.**  
A Song/Disk screen appears.
- 4. Touch <Disk> on the screen.**  
A Song Disk Menu screen appears.
- 5. Choose <Delete>.**  
The following screen will appear.



Touch <Exit> to go back to the Song Disk Menu screen.

- 6. Touch the   to specify a song you want to delete.**
- 7. Touch <Delete> to display a message like the one shown below.**



- 8. Touch <OK>.**  
The song selected is deleted.  
Touching <Cancel> cancels deleting the song.

## Changing the Order of Songs on Floppy Disk

Here's how you can change the order of songs saved on a floppy disk.

- 1. Have ready an empty, formatted floppy disk.**
- 2. Insert the floppy disk containing the saved songs into the disk drive.**
- 3. Press the [Song/Disk] button.**
- 4. Use the touch screen or Page < ◀ > and < ▶ > to select the song to which you would like to assign song number one.**
- 5. After you've chosen a song, touch <Exit> several times.**  
Display the screen where the measure number appears in the top-right area of the screen.
- 6. Press the Play [ ▶ ] button.**  
The measure number on the screen appears in reverse video.
- 7. When the measure number display returns to its original appearance, press the Stop [ ■ ] button.**
- 8. Take the floppy disk out of the disk drive.**
- 9. Insert a blank floppy disk.**
- 10. Save the song in the usual way (p. 109).**

Repeat these steps to save the song you want to have song number 2, the song you want to have song number 3, and so on to the blank floppy disk in the desired song sequence.



For more about formatting, take a look at “Formatting Floppy Disks (Format)” (p. 109).

### NOTE

The measure number of the screen appears in reverse video while the KF-90 reads the song data from floppy disk. Don't take the floppy disk out of the drive until the display returns to its original state.

### NOTE

Some commercially available music files cannot be saved because they are copyrighted.

# Chapter 5 Advanced Recording Function

In addition to the functions introduced in “Chapter 4 Recording and Saving Performances,” the KF-90 features a variety of other recording functions.

## Selecting the Recording Method

You can use any of the four methods below to record with the KF-90.

Although you will normally be using “Replace Recording,” whereby previously recorded material is erased when new sounds are recorded, you’ll find that you can record songs easily by using this method in combination with other recording methods.

- **Replace Recording (p. 116)**

This is the normal method for recording. New material is recorded as previously recorded material is erased.

- **Mix Recording (p. 116)**

New notes are recorded as a layer on top of notes recorded earlier.

- **Loop Recording (p. 116)**

Specified measures are recorded repeatedly, with new notes being combined with existing ones. This is handy when you’re making rhythm parts, such as by layering different percussion tones while recording the same passage over and over.

- **Punch In Recording (p. 117)**

You can re-record only a specified passage as you listen to a recorded performance.

\* *Immediately after the power is turned on, the Replace Recording is selected.*

## How to Choose the Recording Method

### 1. Press the [Composer Navigator] button.

A Composer Navigator screen appears.

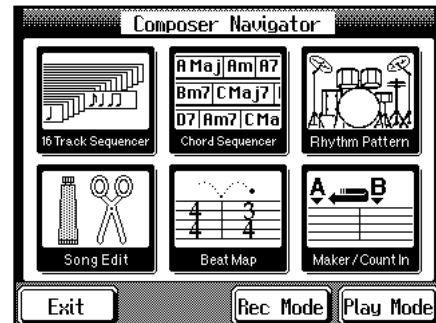

### 2. Touch <Rec Mode>.

A Recording Mode screen like the one shown below appears.



### 3. Touch <Rec Mode> to choose the recording type.

Display	Recording Method
<b>Replace</b>	Replace Recording
<b>Mix</b>	Mix Recording
<b>Loop</b>	Loop Recording
<b>Auto Punch In/OUT</b>	Punch In Recording at the passage between the markers.
<b>Manual Punch In/Out</b>	Punch In Recording starts at the place where you depress the pedal.
<b>Tempo</b>	You can add tempo changes to a recorded composition. See p. 123.

Touch <Exit> to go back to the previous screen.

### ■ Recording While Erasing the Previous Recording (Replace Recording)

Recording whereby you erase previously recorded material as you record something new is called “Replace Recording.” This setting is in effect when you turn on the power.

#### 1. At the Rec Mode screen (p. 115), choose <Replace>.

Touch <Exit> to go back to the previous screen.

The KF-90 enters the Replace Recording mode.

Follow the recording method in Chapter 4 (p. 97) or the procedures described in “Multitrack Recording with 16 Parts (16-Track Sequencer)” (p. 118) to record the performance.

### ■ Overdubbing Without Erasing the Previous Recording (Mix Recording)

You can record a performance layered over an previously recorded performance. This method is called “Mix Recording.”

#### 1. At the Rec Mode screen (p. 115), choose <Mix>.

Touch <Exit> to go back to the previous screen.

The recording method changes to mixing recording.

Record the performance, following the procedures described in “Redoing a Recording” (p. 101) or “Multitrack Recording with 16 Parts (16-Track Sequencer)” (p. 118).

\* After you have finished with mix recording, return to the usual replace recording mode.

### ■ Repeatedly Recording Over the Same Location (Loop Recording)

You can record a specified passage over and over again as many times as you like, layering the sound with each pass. This method is called “Loop Recording.” This is handy when recording a Rhythm Part.

For example, use this method to make a Loop Recording of a four-measure segment.

First record the bass drum, the snare drum next, then the hi-hat after that, and so on, repeatedly layering a different instrument onto the same four measures. After you have finished recording the four-measure rhythm pattern, you can then just use the procedure in “Copying a Measure” (p. 125) to create as many copies of the four measures as you need, making completion of the Rhythm Part very simple.

#### 1. Place A and B markers at the beginning and end of the passage you want to record.

Take a look at “Placing/Erasing a Marker Within a Song” (p. 90).

If you haven’t recorded anything yet, then perform “Blank Recording” for the necessary number of measures before placing the markers.

#### What is Blank Recording?

Blank Recording is the recording of blank measures, that is, measures with no performance recorded to them.

1. Set the basic tempo and beat of the song.
2. Press the Rec [ ● ] button, then press the Play [ ► ] button.

The indicators for the Rec [ ● ] and Play [ ► ] buttons light up, and recording starts.

3. Without actually playing anything, record the necessary number of measures, then press the Stop [ ■ ] button.

The indicators for the Rec [ ● ] and Play [ ► ] buttons go dark, and recording stops.

2. At the Rec Mode screen (p. 115), choose <Loop>.  
Touch <Exit> to go back to the previous screen.  
The recording method changes to loop recording.
3. Press the [Song/Disk] button and touch <Track> to display the Track buttons.
4. Press the Rec [ ● ] button.
5. Touch the Track button for the track you want to record.  
The KF-90 enters standby for recording.
6. Press the Play [ ► ] button to start recording.  
Recording start from the measure which Marker A is placed.  
When the song advances to Marker B, it then returns to Marker A, where recording continues.  
Each time the recording is looped, the sounds being played are layered over the sounds recorded on previous passes.
7. Press the Stop [ ■ ] button to stop recording.

#### Loop Recording Shortcut

You can also use the method described below to make the setting for Loop Recording.

1. Place A and B markers at the beginning and end of the passage you want to record.

Take a look at “Placing/Erasing a Marker Within a Song” (p. 90).

If you haven’t recorded anything yet, then perform “Blank Recording” for the necessary number of measures before placing the markers.

2. At the Marker screen (p. 90), touch the <Repeat> icon.  
This sets the loop recording mode.  
Start a recording.

\* When you’re finished with Loop Recording, return to the ordinary Replace Recording mode at the “Recording Mode” screen.

## ■ Re-Recording Part of Your Performance (Punch-in Recording)

You can re-record only a specified passage as you listen to a recorded performance.

This recording method is called “Punch-in Recording.”

This function lets you record over only at a specified point in a part, as you listen to a prerecorded performance in another section. This is a very convenient feature to have in situations such as when you want to record over only one part of the melody.

Punch-In Recording offers the following two methods.

- **Recording the passage specified by markers A and B (Auto Punch In/Out)**

Before you start recording, place markers A and B to define the passage you want to record over. Make the setting for punch-in recording, and carry out recording. You can re-record just the passage between markers A and B.

- **Beginning recording at the point where the pedal is pressed (Manual Punch In/Out)**

You can play back a recorded performance and depress the pedal at the desired place to start recording. Depressing the pedal a second time cancels recording and returns you to playback.

### Recording a Passage specified by markers

1. **Before you start recording, place markers A and B to define the passage you want to record over.**

Following the procedures described in “Placing/Erasing a Marker Within a Song” (p. 90), use Markers A and B to specify the interval.

2. **At the Rec Mode screen, choose <Auto Punch In/Out>.**

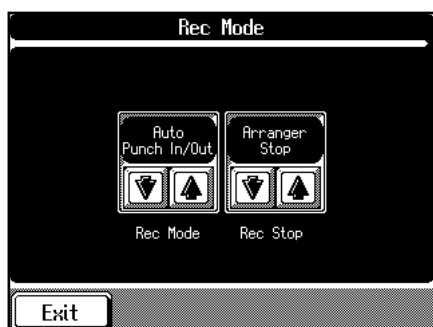

This changes the recording mode to “Punch-In Recording.”

Touch <Exit> to go back to the previous screen.

3. **Start recording.**

Start recording as described in “Redoing a Recording” (p. 101).

Up until the specified interval, the performance as already recorded is played back.

When you reach the specified interval, sounds are erased as recording starts; begin playing now.

When the end of the specified interval is passed, recording stops, and the KF-90 returns to playback of the performance already recorded.

4. **Press the Stop [ ■ ] button to stop playback.**

### Starting Recording from the Measure Specified by Pedals

When you’re using pedals, change the action of the pedal ahead of time.

Follow the steps in “Assigning Functions to Pedals” (p. 147) and assign <Punch In/Out> to the pedal.

1. **At the Rec Mode screen (p. 115), choose <Manual Punch In/Out>.**

This changes the recording mode to “Punch-In Recording.”

Touch <Exit> to go back to the previous screen.

2. **Begin recording.**

Start recording as described in “Redoing a Recording” (p. 101).

The performance that you recorded will be played back. Depress the pedal, and recording will start.

Depressing the pedal again stops recording, and the KF-90 returns to playback of the performance already recorded.

3. **Press the Stop [ ■ ] button, and playback of the song is stopped.**

\* When you’re finished with Punch In Recording, return to the ordinary Replace Recording mode. Take a look at “Selecting the Recording Method” (p. 115).

### Multitrack Recording with 16 Parts (16-Track Sequencer)

Multitrack recording is a method of recording whereby you listen to previously recorded material while continuing to add performances of other parts.

The KF-90 is capable of multitrack recording of up to sixteen parts. Since each part's performance is recorded using one tone, you can layer performances, using up to sixteen tones for the data in one song.

The function used to layer these sixteen parts one at a time is called the "16 Track Sequencer."

#### 16 Track Sequencer

You can record performances for up to 16 parts, overlaying them part by part, to create a single song.

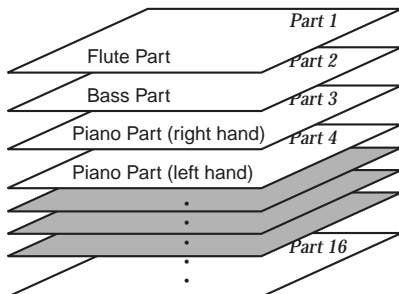

#### 16 Track Sequencer and Track Buttons

In addition to the "16-Track Sequencer" function, the "Track Buttons" are another of the KF-90's recording functions.

These "Track buttons" comprise five buttons used for organizing 16 Track Sequencer's sixteen parts. This allows you to use the 16 Track Sequencer to add even more sounds to performances recorded with the Track buttons, and make even more detailed edits of the songs.

Additionally, you can easily play back the original song data with the 16 Track Sequencer, mute parts just by touching the Track Buttons, and more.

The track buttons correspond to 16-track sequencer parts as shown below.

Track button	Part
[R/Rhythm]	D(10), S(11)
[1/Whole]	1
[2/Accomp]	2, 5 to 9, 12 to 16
[3/Left]	3
[4/Right]	4

Since the 16 Track Sequencer records one tone to one part, you cannot use Layer Play (p. 53), Split Play (p. 55), or other such functions to record two or more tones to one Part simultaneously. Also, you can't record the performance with Automatic Accompaniment.

When you want to record with Automatic Accompaniment, then you should use the Track Buttons for recording. (Refer to "What is a Track Button?" (p. 97).)

#### Commercially Available Music Files

Commercially available song data recorded in Roland's SMF format is also composed of sixteen parts.

By loading the song data from the floppy disk and using the 16 Track Sequencer, you can then also edit the song data.

- \* *Although Part 11 on commercial Roland SMF music data is included in the [Accomp] Track Button, the correspondence between all other parts and the Track Buttons remains unchanged.*
- \* *With some commercially available music files, you cannot edit the data.*

## ■ The 16-track Sequencer Screen

When recording with 16-track Sequencer, display the 16-track Sequencer screen.

1. Press the [Composer Navigator] button.

2. Touch <16Tr. Sequencer>.

The following screen will appear. This is called the “16-track Sequencer screen.”

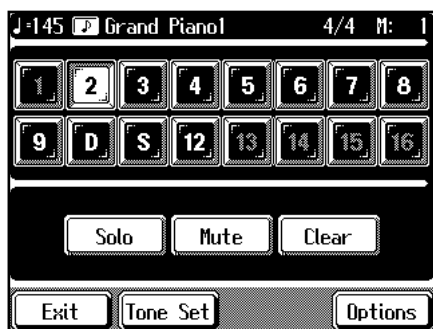

Icon	Description
<1>-<16>	Touch to select the part to be recorded, or the part whose settings are to be changed. The Part you choose is highlighted.
	The selected part
	This Part to be played back
	The Part not to be played back (Muted Part)
	Parts that do not have performance data recorded to them.
<Solo>	Only the selected Part is played back.
<Mute>	This allows you to prevent the sound for the selected part from playing.
<Clear>	This clears the performance data in the selected part.
<Tone Set>	This displays the Tone Set screen. For details, refer to p. 120.
<Options>	This displays the Part Settings screen, in which you can make detailed settings for each part. For more detailed information, refer to p. 120.

## ■ Recording with the 16 Track Sequencer

Step 1 Get ready to record

1. Press the [Song/Disk] button.

2. Select the song number to which you want to record.

To record a new song, select <0: >.

Touch <0: > to change the display to <0:New Song>.

If <0:New Song> doesn't appear on screen, touch Page

< ◀ > and < ▶ > to switch screens.

If you have recorded a song or changed a song's settings, the message “Delete Song OK?” appears on the screen when you touch <0:New Song>. For more information, take a look at “If the following message appears” (p. 99).

3. Press the [Metronome] button and choose the beat (p. 63).

If you do not use the metronome, press the [Metronome] button, turning off the button's indicator.

\* You can't change a song's beat once it's been recorded. If you want to compose a song whose beat changes partway through the song, take a look at “Composing a Song That Changes the Beat Partway Through” (p. 122).

4. Press the Tempo [-] and [+] buttons to set the basic tempo of the song.

\* This procedure cannot be used to change the tempo when prerecorded song data is used. To change the basic tempo of a song, please refer to “Changing a Song's Basic Tempo” (p. 122).

Step 2 Start recording

If necessary, choose a recording method.

For more information, take a look at p. 115 through p. 117.

1. Display the 16-track Sequencer screen.

Follow the procedure described in “16 Track Sequencer Screen” above.

2. Touch the number for the Part you want to record.

The Part you touch appears in reverse video.

You can only record drum sounds or effect sounds on Part D(10) or Part S(11).

### 3. Use the Tone Select buttons to choose a Tone to play.

To record a drum sound or effect sound, press the [Drums/SFX] button (p. 58).

After you've chosen a Tone, touch <Exit> to display the 16-track Sequencer screen.

### 4. Press the Reset [⏮] button.

This makes it so that recording starts at the beginning of the song.

When you want to start recording from a point in the song other than the beginning, use the Bwd [⏪] or Fwd [⏩] button to select the measure from which to start.

### 5. Press the Rec [●] button, getting its indicator to light up.

The KF-90 enters standby for recording.

### 6. Press the Play [▶] button.

A two-bar count-in sounds, then recording starts. Start a recording.

### 7. Press the Stop [■] button.

Recording stops.

When the recording of one part is finished, select another part and continue by recording that part.

Record the parts you need, layering each additional part, to complete the song.

\* You only need to follow the procedure described in "Step 1 Get ready to record" when you're recording the first Part. For the second Part and after, you can skip step 1 and proceed from "Step 2 Start recording."

\* The song you've recorded disappears when you switch off the power. Save the song on a floppy disk. For more information, see "Saving Songs to Floppy Disks" (p. 109).

## ■ Getting the Most Suitable Part Tones for the Musical Genre (Tone Set)

"Tone Set" is a function that assigns to each of the sixteen parts the most suitable tones for the selected musical genre. Whenever you find yourself knowing the kind of song you want to create, but not the tones to use, let Tone Set assign the tones, then alter the tones as necessary to fit the image you have in mind.

### 1. Display the 16-track Sequencer screen.

Press the [Composer Navigator] button and touch <16Track Sequence> to display the screen.

### 2. Touch <Tone Set> at the bottom of the screen.

The following screen will appear.

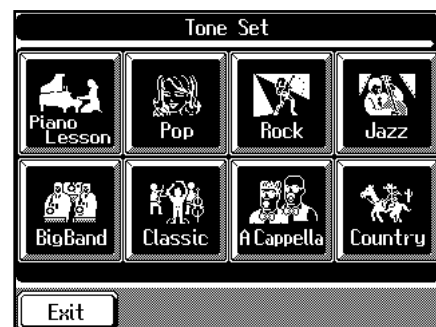

### 3. Touch the screen to select a musical genre.

### 4. Touch <Exit>.

## Changing the Settings of Each Part

---

When you've recorded a song with the 16-track sequencer, you can change the volume level, Tone, or set to mute out the sound for a single Part.

\* Because commercially available Roland SMF Music Data is also made up of 16 Parts for sounding the notes of individual instruments, you can change the settings for the individual Parts and play them back in the same way.

### 1. Press the [Song/Disk] button, and touch the screen to choose the song.

Touch <Exit> to go back to the previous screen.

### 2. Display the 16-track Sequencer screen.

Press the [Composer Navigator] button and touch <16Track Sequence> to display the screen.

A 16-track Sequencer screen like the one shown below appears.



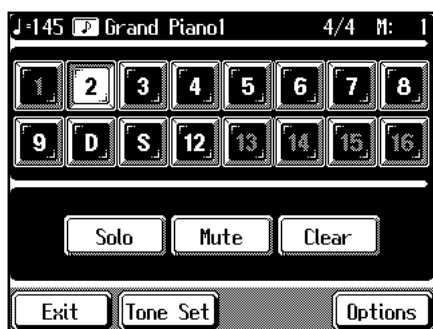

3. Touch the screen to choose the Part for which you want to make settings.

4. Change the settings for the selected Part.

Display	Function
<b>Solo</b>	Only the selected Part is played back.
<b>Mute</b>	Toggles playback of the selected Part on or off.
<b>Clear</b>	Erases the performance information for the Part. Touching <Clear> displays the Message for confirm. To erase the recorded sound, touch <Yes>. If you don't want to erase the recorded sound, touch <Cancel>. Once a performance has been erased, it can't be restored.

5. You can make detailed settings for the selected Part by touching <Options>.

The following screen will appear.

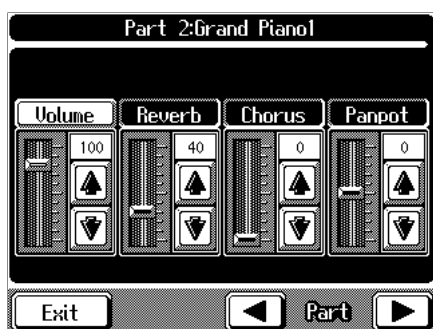

You can change the Tone for the selected Part by pressing a Tone Select button to change the Tone while this screen is displayed. The Part name and the tone name is displayed at the top of the screen.

6. Touch for the corresponding item to change the setting.

Display	Description
<b>Volume</b>	Changes the volume level.
<b>Reverb</b>	Changes the depth of the reverb effect.
<b>Chorus</b>	Changes the amount of chorus applied.
<b>Panpot</b>	Shifts the direction the sound is heard from to the left or right. Touch  to shift the sound to the right, or touch  to shift it to the left.

**What's Panpot?**

Panpot is the control that determines the placement of the sound in the stereo sound field between left and right speakers. By altering the Panpot setting, you can change the perceived location of the sound between the left and right speakers.

7. Press the Play [▶] button to play back the song with the changed settings.

Monitor the effect by actually listening to the song. Press the Stop [■] button to stop playback of the song.

8. If necessary, change the settings for other Parts as well.

Touch Part <◀> and <▶> to change the Parts. The Part name appears at the upper part of the screen.

9. While pressing the Rec [●] button, also press the Reset [◀] button.

This operation set the changes in the settings. The song can then be saved to a floppy disk. If you don't want to lose the song whose settings for individual Parts you've changed, you should save it on a floppy disk (p. 109).

\* The setting that determines whether an individual Part is played or not can't be saved to floppy disk.

**If the following message appears**

If you try to display another screen after you've changed the song's settings for each Part, a message like the one below may appear.



Touch <Yes> to change the song's settings. Touch <No> to discard the changes in settings.

### Composing a Song That Changes the Beat Partway Through

You can create songs that have beat changes during the course of the song.

\* *You can't change a song's beat once it's been recorded. Before recording the performance, determine the beat to be used.*

**1. Press the [Composer Navigator] button.**

The Composer Navigator screen appears.

**2. Touch <Beat Map>.**

The following screen will appear.

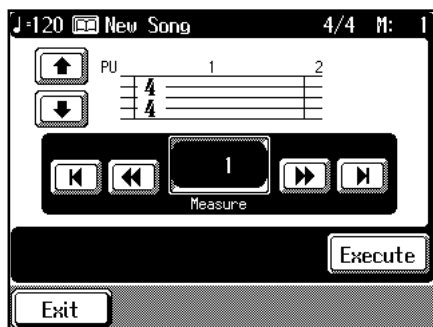

**3. Use the Bwd [ << ] and Fwd [ >> ] buttons or < << >> > on the screen to move to the bar where you want to change the beat.**

The measure number appears in the top-right area of the screen.

Touching < << > goes back to the beginning of the song.

Touching < >> > moves to the end of the song.

**4. Touch [ Up ] [ Down ] to choose the beat, and touch <Execute>.**

The beat change starting with the measure where you moved to.

**5. Touch <Exit> twice.**

The screen displayed before you pressed the [Composer Navigator] button appears.

**6. Press the Reset [ << ] button to return the measure number to "1."**

**7. Start a recording.**

Record the performance, following the procedures described in Chapter 4 (p. 97) or "Multitrack Recording with 16 Parts" (p. 118).

### Changing a Song's Basic Tempo

You can change the basic tempo of a composition. The basic tempo is that was initially set when the song was recorded.

**1. Press the Tempo [-] and [+] buttons to choose a tempo.**

**2. Hold down the Rec [ ● ] button and press the Reset [ << ] button.**

The song's basic tempo changes.

The changed setting is discarded when you turn off the power or choose a different song.

It is a good idea to save important song data to floppy disk (p. 109).

\* *For songs that have tempo changes within the song, first press the Reset [ << ] button to return to the beginning of the song before carrying out this procedure. Changing the tempo without returning to the start of the song causes the proportion by which the tempo is altered at the location of the tempo change to affect the overall tempo of the composition.*

## Changing the Tempo Within the Song

You can add tempo changes to a recorded composition. The KF-90 stores song tempo information and performance data separately. Therefore, when making changes to the tempo in a song, you must record the changes in the tempo information independently of the performance data. This recording of the tempo is called “Tempo Recording.”

### ■ Adjusting the Tempo While Listening to a Song

You can add ritardando and other such gradual tempo changes.

#### 1. Press the [Composer Navigator] button.

The Composer Navigator screen appears.

#### 2. Touch <Rec Mode>.

A Recording Mode screen like the one shown below appears.



#### 3. Touch <Rec Mode> , and choose <Tempo>.

This makes the setting for tempo recording.

Touch <Exit> several times to go back to the screen that shows the measure number in the top-right area of the screen.

#### 4. Press the Bwd [ <<< ] and Fwd [ >>> ] buttons to move to a place a little earlier than the bar where you want to change the tempo.

#### 5. Press the Rec [ ● ] button and confirm that its indicator blinking.

The KF-90 enters standby for recording.

#### 6. Press the Play [ ▶ ] button to start recording.

#### 7. When you get to the place where you want to change the tempo, use the Tempo [-] and [+] buttons or the dial to vary the tempo as desired.

#### 8. Press the Stop [ ■ ] button to stop recording.

The song's tempo changes.

\* You cannot record performances while in Tempo Recording mode. When you're finished tempo recording, go back to the ordinary Replace Recording. Take a look at “Selecting the Recording Method” (p. 115).

### ■ Adjusting the Tempo at a Particular Measure

You can have the tempo change at the beginning of a measure where you moved to. This is handy when you want to make a sudden change in tempo.

#### 1. Make the setting for Tempo Recording at the Recording Mode screen.

The steps are the same as the steps 1 to 3 in “Adjusting the Tempo While Listening to a Song”.

#### 2. Using the Bwd [ <<< ] and Fwd [ >>> ] buttons, move to the measure where you wish to change the tempo.

The measure number appears in the top-right area of the Basic screen (p. 19).

#### 3. When you press the Rec [ ● ] button, the button's indicator flashes.

The KF-90 enters standby for recording.

#### 4. Use the Tempo [-] and [+] buttons or the dial to adjust the tempo.

#### 5. Press the Rec [ ● ] button.

The song's tempo changes starting with the measure where you moved to.

#### 6. Press the Stop [ ■ ] button to end recording.

\* You cannot record performances while in Tempo Recording mode. When you're finished tempo recording, go back to the ordinary Replace Recording. Take a look at “Selecting the Recording Method” (p. 115).

\* If you want to restore the previous tempo, delete the tempo data at the place where the tempo was recorded. For an explanation of how to delete the information of tempo settings, refer to the “Making a Measure Blank” (p. 129).

#### Tempo Recording Shortcut

You can also enter the Tempo Recording mode by holding down the Tempo [-] or [+] button and pressing the Rec [ ● ] button.

Record tempo information.

In this case, tempo recording is canceled when recording ends.

# Chapter 6 Editing Functions

## Choosing an Editing Function

There is a variety of ways you can edit performances recorded using the KF-90 Track buttons or 16-track sequencer.

1. Press the [Composer Navigator] button, getting its indicator to light up.

The Composer Navigator screen appears.

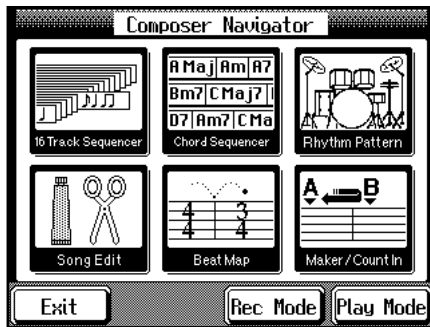

2. Touch <Song Edit>.

A Song Edit screen like the one shown below appears.

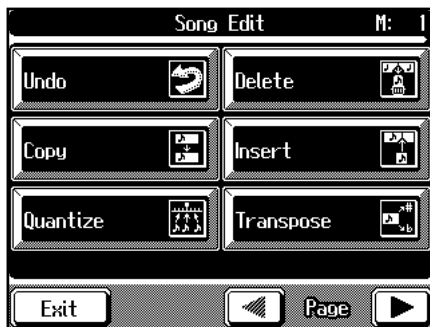

Touch Page <◀> and <▶> to switch screens and display other editing functions.

3. Touch Page <◀> and <▶> to switch screens and choose an editing function.

After you make your choice, follow the steps on the page for the selected function to carry out the operation.

Display	Description
<b>Undo</b>	Cancels an editing operating (p. 124).
<b>Copy</b>	Copies a measure or onboard rhythm pattern (p. 125, p. 126).
<b>Quantize</b>	Corrects discrepancies in the timing of notes in a recorded performance (p. 126).
<b>Delete</b>	Deletes a measure (p. 127).
<b>Insert</b>	Adds a blank measure (p. 128).
<b>Transpose</b>	Transposes a Part (p. 128).
<b>Erase</b>	Makes a measure blank (p. 129).

**Part Exchange** Exchanges (swaps) the notes in two Parts (p. 130).

**Note Edit** Used to correct individual notes one at a time (p. 130).

**PC Edit** Used to correct changes in Tones during the course of a song (p. 131).

Touch <Exit> to go back to the previous screen.

→ “PC” is an abbreviation for Program Change, which is a command that means “Change the Tone.” In a song that changes Tones partway through, a “PC” is inserted at the place where the Tone changes.

## Canceling an Edit

You can cancel an editing operation that you’ve just carried out. This is handy when you want to undo an edit and restore it to the way it was before.

1. Follow the steps in “Choosing an Editing Function” to choose <Undo>.

Editing functions that can be undone appear on screen.

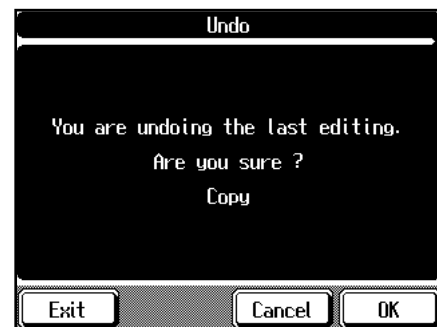

2. Touch <OK> to cancel the editing function shown on screen.

Touch <Cancel> to go back to the Edit screen.

→ Some edits can’t be undone, not even by choosing “Undo.” We recommend saving your song on a floppy disk or User Memory before you edit it. For information on how to save your song, see “Saving Songs to Floppy Disks” (p. 109).

## Copying a Measure

You can copy a portion of a performance to a different bar in the same Part or to a measure in another Part. This is handy when you're composing a song that repeats a similar phrase.

Ex. To copy measure 5-7 to measure 8.

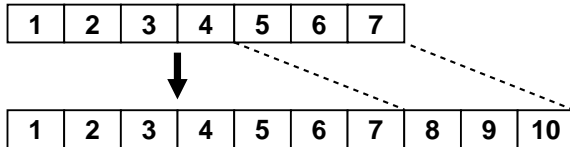

### 1. Follow the steps in “Choosing an Editing Function” (p. 124) to choose <Copy>.

The following screen will appear.

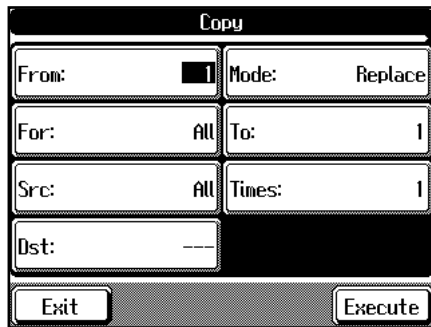

Display	Description
<b>From</b>	The first measure in the passage you want to copy
<b>For</b>	The number of measures to copy
<b>Src</b>	Track button or Part number of the copy source Choosing “All” copies all Parts. When you do this, <Dst> changes to “- - -.” Choosing “R.Pattern” copies the KF-90’s built-in Rhythm Patterns. For more information, take a look at “Copying a Rhythm Pattern” (p. 126). If you choose a Track button, you can only copy to the selected Track button.
<b>Dst</b>	Track button or Part number of the copy destination
<b>Mode</b>	Copy type There are three types of copying, which are described below.  <b>“Replace”</b> When a recorded performance exists at the copy destination, the previous recording is deleted and replaced with the copied passage.

### “Mix”

When a recorded performance exists at the copy destination, the newly copied passage is mixed with the previous recording. When the Tones of the copy source and destination are different, the Tone of the destination is used.

### “Insert”

When a recorded performance exists at the copy destination, the newly copied passage is inserted without deleting the previous recording. This makes the song longer by an amount equal to the number of inserted measures.

<b>To</b>	The measure number of the copy destination Choosing “End” copies to the end of the song.
<b>Times</b>	The number of times to copy

### 2. Touch the screen to choose the item you want to make the setting for.

### 3. Use the Value [-] [+] buttons or the dial to set the item.

To cancel copying, touch <Exit>.

The copy is canceled, then you are returned to the Song Edit screen.

### 4. When you're done making all the settings, touch <Execute>.

Copying starts.

When copying is done, you are returned to the Song Edit screen.

## Copying a Rhythm Pattern

The KF-90 has a large number of onboard rhythm patterns. You can copy these rhythm patterns to create a rhythm part. For more information about the kind of Rhythm Patterns, please refer to “Rhythm Pattern List” (p. 177).

1. Follow the steps in “Choosing an Editing Function” (p. 124) to choose <Copy>. For more about ordinary copying, please refer to “Copying a Measure” (p. 125).
2. Touch <Src>, and use the dial to choose “R.Pattern.” This makes the setting for copying a built-in Rhythm Pattern.

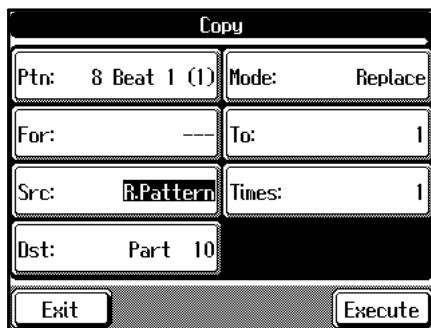

- <From> changes <Ptn>, and the column displays the Rhythm Pattern’s name and number of bars.
- <Dst> is fixed at “Part 10 (D),” and can’t be changed.
- Switching <Src> to something other than “R.Pattern” makes the setting for ordinary copying.

3. Touch the screen to choose the item you want to make the setting for.
4. Use the Value [-] and [+] buttons or the dial to set the item.

Press the Play [▶] button to hear the rhythm pattern. Press the Stop [■] button to stop playing the rhythm pattern. Touching <Exit> returns you to the “Song Edit screen,” without the copy being executed.

5. When you’re done making all the settings, touch <Execute>.

Copying starts. When copying is done, you are returned to the Song Edit screen.

→ You can also record the rhythm pattern. Take a look at “Creating a Rhythm Part with Ease” (p. 108).

## Correcting Timing Discrepancies

You can correct for timing discrepancies in a recorded performance by having the music be aligned with a timing you specify. This is called “Quantizing.”

As an example, let’s say that the timing of some quarter-notes in a performance is a little off. In this case, you can quantize the performance with quarter-note timing, thus making the timing accurate.

Example: Quarter-note resolution

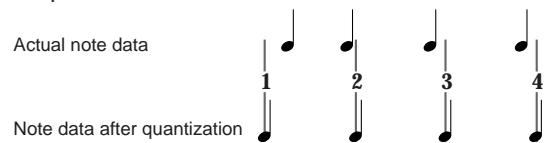

Example: Sixteenth-note resolution

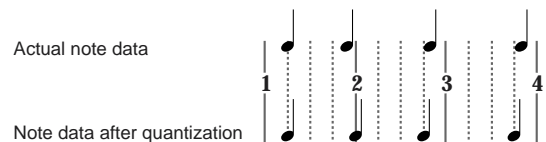

1. Follow the steps in “Choosing an Editing Function” (p. 124) to choose <Quantize>.

The following screen will appear.

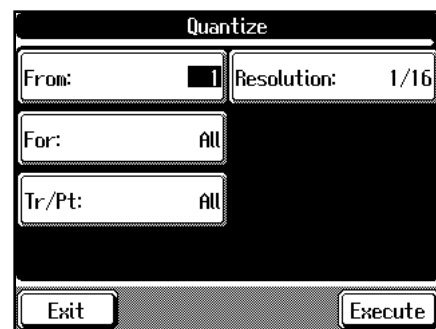

Display	Description
<b>From</b>	The first measure in the passage you want to quantize
<b>For</b>	The number of measures you want to quantize
<b>Tr/Pt</b>	Track button or Part number to quantize Choosing “All” quantizes the same passage in all Parts.
<b>Resolution</b>	Timing of quantizing Select one of the following values. 1/2 (half note), 1/4 (quarter note), 1/6 (quarter-note triplet), 1/8 (eighth note), 1/12 (eighth-note triplet), 1/16 (sixteenth note), 1/24 (sixteenth-note triplet), 1/32 (thirty-second note)

2. Touch the screen to choose the item you want to make the setting for.

3. Use the Value [-] [+] buttons or the dial to make the setting for the item.

If you want to cancel quantizing, touch <Exit>. The Quantize operation will be canceled, and the Song Edit screen will reappear.

4. When you're done making all the settings, touch <Execute>.

Quantizing starts. When the quantization is finished, you are returned to the Song Edit screen.

## Deleting a Specific Measure

You can delete a part of a performance measure by measure. When a portion of a performance is deleted, the rest of the performance is shifted up to fill the gap. This erasure of portions of a performance is called "Deleting."

Ex. To delete measures (bars) 5-8

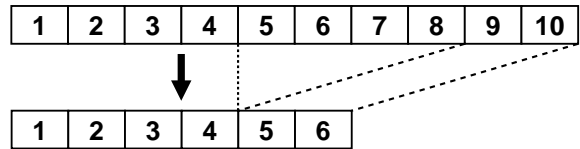

1. Follow the steps in "Choosing an Editing Function" (p. 124) to choose <Delete>.

The following screen will appear.



Display	Description
From	The first measure in the passage you want to delete
For	The number of measures to delete
Tr/Pt	Track button or Part number to delete Choosing "All" deletes the same location in all Parts.

2. Touch the screen to choose the item you want to make the setting for.

3. Use the Value [-] [+] buttons or the dial to set the item.

To cancel deletion of the measure, touch <Exit>. The deletion is canceled and the KF-90 goes back to the Song Edit screen.

4. When you're done making all the settings, touch <Execute>.

The deletion process starts. When the deletion is finished, you are returned to the Song Edit screen.

### Inserting a Blank Measure

You can add a blank measure at a location you specify. This addition of a blank measure is called “Insertion.”

Ex. To insert measures (bars) 5-7

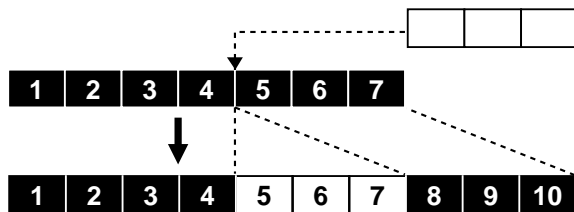

1. Follow the steps in “Choosing an Editing Function” (p. 124) to choose <Insert>.

The following screen will appear.



Display	Description
<b>From</b>	The first measure in the passage you want to insert
<b>For</b>	The number of measures to insert
<b>Tr/Pt</b>	Track button or Part number to insert Choosing “All” inserts the blank measures at the same location in all Parts.

2. Touch the screen to choose the item you want to make the setting for.
3. Use the Value [-] [+] buttons or the dial to set the item.  
To cancel insertion of a blank measure, touch <Exit>. The insertion is canceled and the KF-90 goes back to the Song Edit screen.
4. When you’re done making all the settings, touch <Execute>.  
Insertion of a blank measure starts. When insertion is finished, you are returned to the Song Edit screen.

### Transposing Individual Parts

You can transpose specified parts and tracks individually.

1. Follow the steps in “Choosing an Editing Function” (p. 124) to choose <Transpose>.

The following screen will appear.

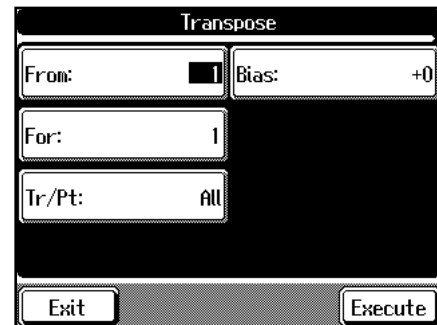

Display	Description
<b>From</b>	The first measure in the passage you want to transpose
<b>For</b>	The number of measures to transpose
<b>Tr/Pt</b>	Track button or Part number to transpose Choosing “All” transposes the same location in all Parts.
<b>Bias</b>	The amount of transposition You can choose a value from -24 (two octaves lower) to +24 (two octaves higher), in semitone increments.

2. Touch the screen to choose the item you want to make the setting for.
3. Use the Value [-] [+] buttons or the dial to set the item.  
To cancel transposition, touch <Exit>. The transposition is canceled and the KF-90 goes back to the Song Edit screen.
4. When you’re done making all the settings, touch <Execute>.  
The passage you specified is transposed at the specified value. When transposition is finished, you are returned to the Song Edit screen.



## Making a Measure Blank

You can delete the performance data in a specified block of measures, making these blank measures, without reducing the length of the song. This process of making certain measures blank is called “Erasing.”

Ex. To erase measures (bars) 5-8

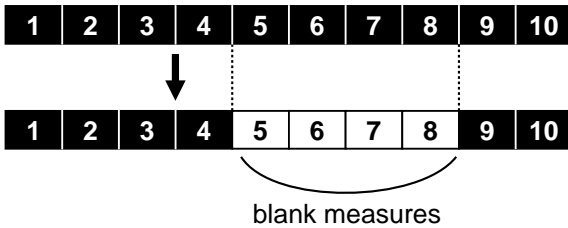

1. Follow the steps in “Choosing an Editing Function” (p. 124) to choose <Erase>.

The following screen will appear.



Display	Description
<b>From</b>	The first measure in the passage you want to blank out
<b>For</b>	The number of measures to blank out
<b>Tr/Pt</b>	Track button or Part number to blank out Choosing “All” blanks out the same location in all Parts.
<b>Event</b>	Performance information to erase Select from the following settings.  <b>“All”</b> Erases all performance information, such as the notes, tempo, tone changes, and volume-level changes.  <b>“Tempo”</b> Erases tempo information. By erasing the tempo information for all bars, the song will change with a uniform tempo. In this case, please choose “All” for <Tr/Pt>.

**“Prog.Change”**

Erases tone change information.

**“Note”**

Erases only notes.

**“Except Note”**

Erases performance information for everything but notes.

**“Expression”**

Erases Expression (volume change) information.

2. Touch the screen to choose the item you want to make the setting for.
3. Use the Value [-] [+] buttons or the dial to set the item.  
To cancel the erase operation, touch <Exit>. The erase operation is canceled and the KF-90 goes back to the Song Edit screen.
4. When you’re done making all the settings, touch <Execute>.  
The specified passage is blanked out. When erasing is finished, you are returned to the Song Edit screen.

### Exchanging Parts



You can exchange the notes recorded for a particular part with the notes recorded for another part.

This process of swapping parts is called “Part Exchange.”

1. Follow the steps in “Choosing an Editing Function” (p. 124) to choose <Part Exchange>.

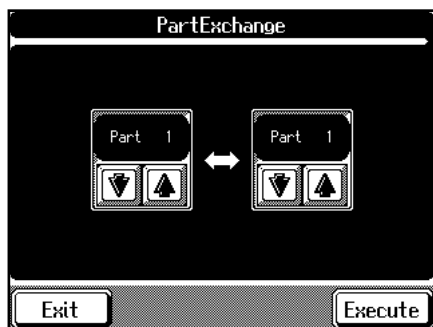
The following screen will appear.



2. Touch each   to choose Parts you want to exchange.

If you want to cancel the Part exchange, touch <Exit>. The part-exchanging is canceled, then you are returned to the Song Edit screen.

3. When you're done making all the settings, touch <Execute>.

When the part-exchanging process is finished, you are returned to the Song Edit screen.

### Correcting Notes One by One

You can make corrections in a recorded performance one note at a time. This process of making changes in individual notes is called “Note Editing.”

- You can make the corrections described below by using Note Editing.
  - Deleting misplayed notes
  - Changing the scale of a single note
  - Changing the key velocity of a single note

1. Follow the steps in “Choosing an Editing Function” (p. 124) to choose <Note Edit>.

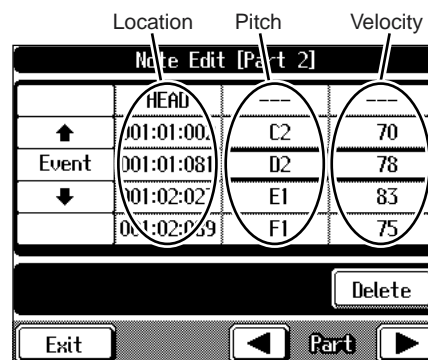

The following screen will appear.



The note-location display uses “Measure: Beat: Tick” as the format. A tick is a unit of time that’s shorter than a beat.

2. Touch Part <◀> and <▶> to choose the Part that contains the note you want to change.

The Part number appears at the top of the screen.

3. Press the Bwd [◀◀] and Fwd [▶▶] buttons or touch   on the screen to find the note you want to correct.

Once you touch <Event>, then you can also search the note by the dial.

4. When you've found the note you want to correct, touch <Pitch> or <Velocity> for the note.

5. Use the dial or the Value [-] [+] buttons to correct the pitch or velocity. If you want to delete the note, touch <Delete>.

6. When you're done making all the settings, touch <Exit>.

You are returned to the Song Edit screen.

## Modifying the Tone Changes in a Song

In some songs, the instrument sound changes during the course of the song (that is, the Tone changes in the middle of a Part). In such songs, an instruction to switch the Tone is inserted at the place where you want the sound to change. This instruction is called a “Program Change” (PC), and actions such as deleting program changes, or changing the Tone that is selected by them are called “PC Editing.”

### 1. Follow the steps in “Choosing an Editing Function” (p. 124) to choose <PC Edit>.

The following screen will appear.

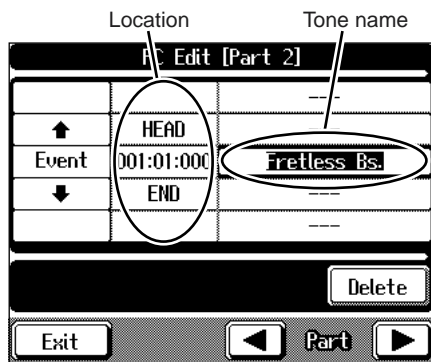

The PC-location display uses “Measure: Beat: Tick” as the format. A tick is a unit of time that’s shorter than a beat.

### 2. Touch Part < ◀ > and < ▶ > to choose the Part that contains the note you want to change.

The Part number appears at the top of the screen.

### 3. Press the Bwd [ ◀◀ ] and Fwd [ ▶▶ ] buttons or touch [ ↑ ] [ ↓ ] on the screen to find the note you want to correct.

Once you touch <Event>, then you can also search the note by the dial.

### 4. When you’ve found the Program Change you want to modify, touch <Tone Name> on the screen.

### 5. Use the Tone Select buttons to choose the Tone group, and use the dial to choose one of the tones.

If you want to delete the Program Change, touch <Delete>.

### 6. When you’re done making all the settings, touch <Exit>.

You are returned to the Song Edit screen.

# Chapter 7 Using Other Functions

## Creating an Original Style (User Style)

The KF-90 has built-in Music Styles in a variety of genres, but you can also create your own original styles.

An original style is called a “User Style.”

You can use either of the two methods described below to create a User Style with the KF-90.

### Style Composer

This method combines the KF-90's onboard styles to create a new style.

You can create a new style just by selecting from among the Rhythm, Bass, Accompaniment 1, Accompaniment 2, and Accompaniment 3 parts from different styles.

### Style Converter (p. 134)

This method extracts the portions you need from songs composed with the 16-track sequencer to create a new style.

When you're composing a song, there's no need to specify all the chords. You can specify just some of the chords, and working on that, the KF-90 automatically extrapolates the other chords, and arranges the style.

The Style Converter has an “Auto Mode” for creating Music Styles simply from a song with a single chord, and a “Manual Mode” for creating a Music Style from a song of three chords (major, minor, and diminished seventh).

## ■ Combining Styles to Create a New Style (Style Composer)

You can create a new User Style by selecting the Rhythm, Bass, Accompaniment 1, Accompaniment 2, and Accompaniment 3 parts from different styles. This function is called the “Style Composer”.

\* You can only combine the KF-90's built-in styles.

### 1. Press the [Style Navigator] button.

The Style Navigator screen appears.

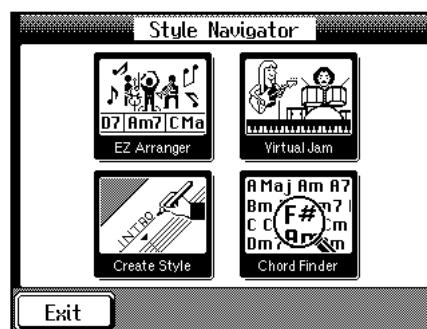

### 2. Touch <Create Style>.



### 3. Touch <Style Composer>.

\* If a User Style has already been recorded, a message like the one shown below appears.

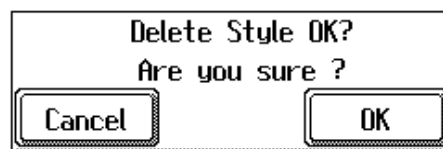

- Touch <Cancel> to display the Style Navigator screen. Please save the User Style on a floppy disk or in the internal memory (p. 137).
- Touch <OK> to erase the previous User Style.

A Style Composer Screen like the one shown below appears.



Display	Part
R	Rhythm
B	Bass
A1	Accompaniment 1
A2	Accompaniment 2
A3	Accompaniment 3
<All Clear>	Erase all of the data that has been input.
<Mute>	You can mute the sound of particular Parts in specific Divisions. For more information, take a look at “Muting Parts for a Particular Division” (p. 133).
<Clear>	Cancels the selection of the Style.
<Options>	Displays the Part Settings screen, in which you can make detailed settings for each part. For more information, take a look at “Changing the Settings for Each Part” (p. 134)
<Execute>	This records the style you have composed. Touch here when you finished creating a style.

4. Touch the screen to choose the Part whose style you want to change.  
The Part you touched appears in reverse video.
5. Press the Music Style button, then choose a Style by using the Touch Screen, the Value [-] [+] buttons or the dial.
6. After you've chosen a style, touch <Exit> to display the Style Composer screen.
7. Repeat steps 4, 5, and 6 to determine the style for each Part.
8. When you have finished setting the Styles for all Parts, touch <Execute>.  
You create a new Style.  
The User Style is recorded to the [Disk/User] button. Try playing with the created Style to play.

\* If you turn off the power or record a new User Style, any User Style you've previously recorded is lost. If you don't want to lose it, you should save it on a floppy disk. Take a look at “Saving a User Style” (p. 137).

### Muting Parts for a Particular Division

You can mute the sound of particular Parts in specific Divisions.

For instance, you can sound all parts when in Variation (the Variation accompaniment pattern), or mute out Accompaniment 2 and Accompaniment 3 when in Original (the Original accompaniment pattern). This has the effect of making the accompaniment more lively when you change the accompaniment pattern from Original to Variation.

→ For more about Division, see “The Makeup of a Style” (p. 134).

1. Touch the Part you want to mute out at the Style Composer screen.
2. Press the button to switch to the Division that you want to silence.

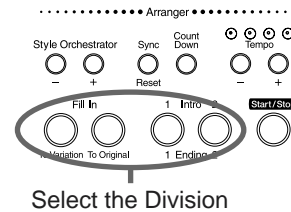

3. Touch <Mute> on the screen.  
The Part you chose is muted out in just the Division you selected. If you want to hear the muted-out Part, touch <Mute> again.  
To mute out a Division that changes after a few seconds (intro, ending, or fill-in), touch <Mute> immediately after switching to the Division.

### Changing the Settings for Each Part

1. At the Style Composer screen, touch <Options>.

The following screen will appear.



2. Press Part < ◀ > and < ▶ > to choose the Part that contains the settings you want to change.

The Part number and the tone name is displayed at the top of the screen.

3. Touch the corresponding to change the settings for each item.

Display	Description
<b>Volume</b>	Adjusts the volume level.
<b>Reverb</b>	Adjusts the depth of the reverb effect.
<b>Chorus</b>	Adjusts the amount of chorus.
<b>Panpot</b>	Shifts the direction the sound is heard from to the left or right. Touch  to shift the sound to the right, or touch  to shift it to the left.

You can change the Tone for the selected Part by pressing the Tone Select button.

4. When you're done changing the settings, touch <Exit>.

The Style Composer screen appears.

### ■ Creating a Style from a Song You Composed Yourself (Style Converter)

You can take a song you've composed yourself and extract the portions you need to create your own original Style.

Note that when you're composing a song, there's no need to specify all the chords. You can specify just some of the chords, and working on that, the KF-90 automatically extrapolates the other chords, and arranges the style.

The Style Converter has an "Auto Mode" for creating Music Styles simply from a song with a single chord, and a "Manual Mode" for creating a Music Style from a song of three chords (major, minor, and diminished seventh).

When you're creating a song for User Style, think about the structure of the style.

### The Makeup of a Style

A Music Style is made up of five performance parts:

"Rhythm," "Bass," "Accompaniment 1," "Accompaniment 2," and "Accompaniment 3."

Also, a song progresses in a sequence, such as intro, melody A, melody B, bridge, and ending.

With the KF-90, such changes in songs are allocated to the following six performance states. The six performance states are called "Divisions" for Style.

Division	Performance division
<b>Intro</b>	The intro is played at the start of a song.
<b>Ending</b>	This is played at the end of a song.
<b>Original</b>	This is a basic accompaniment pattern.
<b>Variation</b>	This is a developmental accompaniment pattern.
<b>Fill In To Variation</b>	This is a one-measure phrase inserted at a juncture where the mood changes. It is used to make a song more lively.
<b>Fill In To Original</b>	This is a one-measure phrase inserted at a juncture where the mood changes. It is used to make a song more sedate.

You can make a song more lively or more restrained by increasing or reducing performance parts by Divisions. You can also modify a song by changing the tone of the performance parts by Divisions.

## Creating a Style in Auto Mode

### Tips on creating a song

- Use one of the major, minor, or diminished seventh chords to create the song. We recommend using diminished seventh chords to compose the song.
- It can be convenient to record the sounds shown below for the Parts of the 16-track sequencer.

Rhythm	Bass	Accomp1	Accomp2	Accomp3
D (10)	2	7	8	9

→ If you want to extract the performance of a part other than Part 2, 7, 8, 9, or D, check out “Changing an Extracted Part” (p. 136).

### 1. Use the 16-track sequencer to record the song.

→ Refer to “Recording with the 16 Track Sequencer” (p. 119) and record the song.

### 2. Press the [Style Navigator] button.

The Style Navigator screen appears (p. 132).

### 3. Touch <Create Style>.

### 4. Touch <Style Converter>.

\* If a User Style has already been recorded, a message like the one shown below appears.



- Touch <Cancel> to return the Style Navigator screen. Please save the User Style on a floppy disk or in the internal memory (p. 137).
- Touch <OK> to erase the previous User Style.

A Style Converter Screen like the one shown below appears.

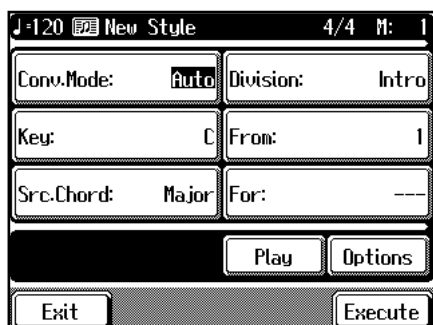

Display	Description
Conv. Mode	Changes the Style Converter Mode (Auto/Manual)
Key	The basic key of the recorded performance
Src. Chord	The chord of the recorded performance (Major/Minor/7th)
Division	Division
From	The first measure in the passage you want to extract
For	The number of measures to extract

### 5. Touch <Conv. Mode>, then use the Value [-] [+] buttons or the dial to switch to “Auto.”

This makes the setting for the Auto mode.

### 6. Touch <Key> and <Src. Chord>, then use the Value [-] [+] buttons or the dial to enter the basic key and chord for the recorded song.

### 7. Touch <Division> and use the Value [-] [+] buttons or the dial to choose a division.

Display	Performance division
Intro	Intro
Original	Original accompaniment pattern
Fill to Vari	Fill-in to Variation
Variation	Variation accompaniment pattern
Fill to Org	Fill-in to Original
Ending	Ending

\* If you select “Fill to Vari” (Fill-in to Variation) or “Fill to Org” (Fill-in to Original) as the Division, you can only extract one measure. The number of measures may be limited for other Divisions as well.

### 8. Touch <From> and <For>, and use the Value [-] [+] buttons or the dial to choose the measures you want to extract.

Touching <Play>, you can listen to performance of the portion which you chose.

### 9. Repeat steps 7 and 8 to make the settings for all Divisions.

\* If no setting is made for a Division, it uses a simple drum pattern.

### 10. When you’re done making all the Division settings, touch <Execute>.

The User Style is recorded to the [Disk/User] button.

## Chapter 7 Using Other Functions

- \* If you turn off the power or record a new User Style, any User Style you've previously recorded is lost. If you don't want to lose it, you should save it on a floppy disk or in the internal memory. Take a look at "Saving a User Style" (p. 137).
- \* The data described below is saved in a User Style. If a song includes data other than this, the results you get might not be what was intended.
  - Keyboard performance information
  - Depth of Reverb
  - Amount of Chorus

### Creating a Style in Manual Mode

When you create a Music Style in the Manual mode, you can clearly point up the differences in accompaniment for each individual chord.

#### Tips on creating a song

- Record your performance with the three chord types of diminished seventh, major, and minor.
- It can be convenient to record the sounds shown below for the Parts of the 16-track sequencer.

Chords	Rhythm	Bass	Accomp1	Accomp2	Accomp3
Major	D(10)	3	4	5	6
Sevens	-	2	7	8	9
Minor	-	12	13	14	15

→ The chords all share the same Rhythm Part.

→ If you want to use the performance of other part, check out "Changing an Extracted Part."

#### 1. Use the 16-track sequencer to record the song.

→ Refer to "Recording with the 16 Track Sequencer" (p. 119) and record the song.

#### 2. Press the [Style Navigator] button.

#### 3. Touch <Create Style>.

#### 4. Touch <Style Converter>.

#### 5. Touch <Conv. Mode>, then use the Value [-] [+] or the dial to switch to "Manual."

This makes the setting for the Manual mode.

After that, the steps are the same as for "Creating a Style in Auto Mode" (p. 135).

→ You can listen to a performance of the part selected with <Options> by touching <Play> at the bottom of the screen.

### Changing an Extracted Part

You can choose which part of the 16-track sequencer to extract the performance from.

#### 1. Touch <Options> at the Style Converter screen.

The following screen will appear.

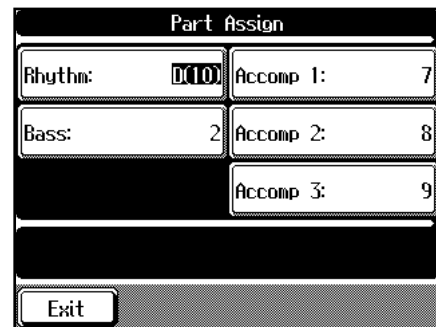

#### 2. Choose the performance Part you want to change, and press the Value [-] [+] buttons or the dial to determine which 16-track Sequencer part has the performance you want to extract.

- \* In the Manual Mode, the type of chords appear at the bottom of the screen. Set the Parts for all chords.

#### 3. Touch <Exit> to go back to the previous screen.



## Saving a User Style

You can save a User Style you've created on a floppy disk or the [Disk/User] button (the KF-90's internal memory). When you save a User Style to the [Disk/User] button, the style doesn't disappear even when you switch off the power. You can choose the saved User Style by pressing the [Disk/User] button. You can save up to 3 User Styles on the [Disk/User] button.

### ■ Saving on the Floppy Disk

**1. Insert a floppy disk into the disk drive.**

→ Refer to "Inserting and Ejecting a Floppy Disk" (p. 39).

**2. Press the [Disk/User] button.**

The Disk/User screen will appear.



**3. Touch <Disk>.**

**4. Touch <Save>.**

The following screen is called up.

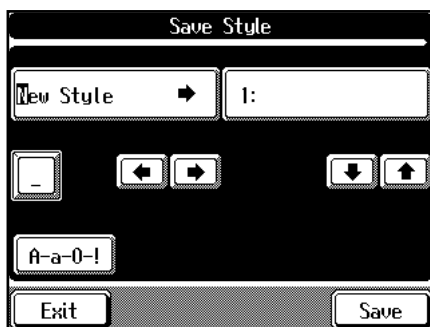

**5. Touch [Left] [Right] to scroll the cursor sideways, and enter the name of the style by using the Value [-] [+] buttons or the dial to choose the letters.**

Touch <A-a-0-!> at the bottom of the screen to change the type of script.

Each touch of <A-a-0-!> cycles the type of characters through "English (upper case)," "English (lower case)," "numerals," "symbols," then back to "English (upper case)."

To delete the character under the cursor, touch <\_>.

**6. After you've enter the style name, use [Up] [Down] to choose the destination for saving it.**

\* If you select a location where a User Style has already been saved, the previously saved User Style is erased and the new one is saved.

Touching <Exit> takes you back to the previous screen without saving the User Style.

**7. Touch <Save> on the screen.**

The saving process starts.

\* Don't take the floppy disk out of the disk drive until the saving process is finished.

### ■ Saving on the [Disk/User] button

**1. Press the [Disk/User] button.**

The Disk/User screen will appear.

**2. Touch <Memorize>.**

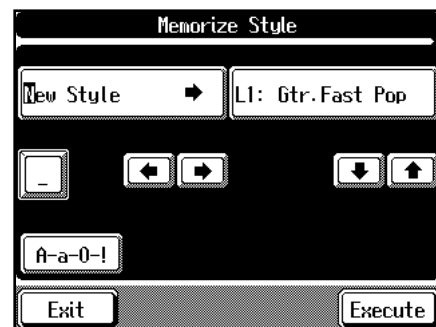

**3. Enter the name of the style and choose the destination for saving it following the step 5 and 6 described in "Saving on the Floppy Disk."**

**4. Touch <Execute>.**

The User style is stored on the KF-90's [Disk/User] button.

\* Never try to switch off the power while this operation is in progress. Doing so may damage the internal memory, making it impossible to use this instrument.

→ You can return the settings stored on the [Disk/User] button to the product's factory defaults. Check out "Restoring the Factory Settings (Factory Reset)" (p. 154).

\* Attempting to save a User Style containing a lot of performance data to the [Disk/User] button may cause another User Style to be erased.

### ■ Deleting a User Style Saved on Floppy Disk



You can erase a User Style saved on a floppy disk.

1. **Insert the floppy disk into the disk drive.**  
→ Refer to “Inserting and Ejecting a Floppy Disk” (p. 39).
2. **Press the [Disk/User] button.**
3. **Touch <Disk>.**



4. **Touch <Delete>.**



5. **Touch   to select the Style you want to delete.**

6. **Touch <Delete> on screen.**  
The following screen will appear.

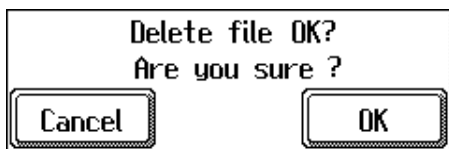

7. **Touch <OK>.**  
The Style selected is deleted.  
Touching <Cancel> cancels deleting the Style.

### Storing the Panel Settings (User Program)



You can store the presently selected buttons, feature settings, and the like to the [User Program] button (internal memory). You can then call up the stored settings by pressing the [User Program] button. This is handy for storing often-used combinations of styles, tone, and other settings. Such a set of stored settings is called a “User Program.”  
With the KF-90, you can store up to 36 User Programs in memory.



1. **Press the [User Program] button.**  
The following screen will appear.

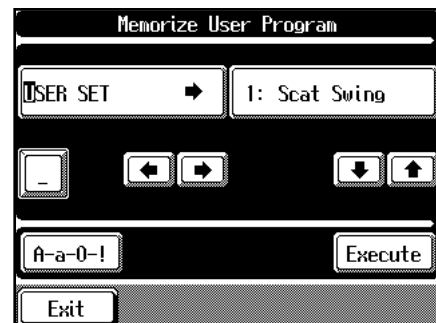

2. **Touch <Memorize>.**  
The following screen is called up.



3. **Touch   to scroll the cursor sideways, and enter the name of the button by using the Value [-] [+] buttons or the dial to choose the letters.**  
Touch <A-a-0-!> at the bottom of the screen to change the type of script.  
Each touch of <A-a-0-!> cycles the type of characters through “English (upper case),” “English (lower case),” “numerals,” “symbols,” then back to “English (upper case).”  
To delete the character under the cursor, touch <\_>.

4. After you've entered a name, touch   to choose a destination for saving the button settings.

Touch <Exit> to go back to the previous screen.

5. Touch <Execute> on the screen.

The present panel settings (User Program) are stored on the KF-90's [User Program] button.

\* Never try to switch off the power while this operation is in progress. Doing so may damage the internal memory, making it impossible to use this instrument.

→ You can return the settings stored on the [User Program] button to the product's factory defaults. Check out "Restoring the Factory Settings (Factory Reset)" (p. 154).

## Calling Up User Program

1. Press the [User Program] button.
2. Touch the name of the User Program you want to call up.

If the User Program you want to call up is not displayed, touch Page < ◀ > and < ▶ > to switch screens.

Touching the User Program name changes the panel settings to the stored values.

### ■ Changing How Button Settings Are Called Up

If you wish, for times when you call up a User Program, you can set it so settings related to automatic accompaniment aren't changed unless you continue touching the Touch Screen for a certain period of time.

1. Press the [User Program] button.
2. Touch <Options>.

A screen like the one shown below appear.

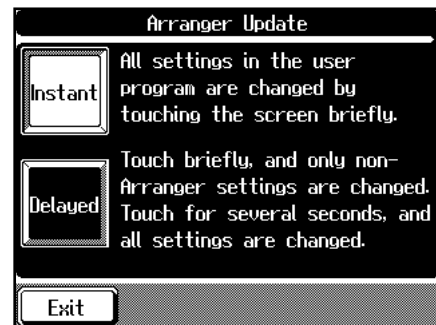

3. Touch <Instant> or <Delayed>.

Display	Description
<b>Instant</b>	The settings related to automatic accompaniment are also switched right away when you touch the screen.
<b>Delayed</b>	To change the settings related to automatic accompaniment, touch and continue pressing the screen for a short while.

Touch <Exit> to go back to the previous screen.

## Saving User Programs on Floppy Disk

You can save all User Programs now stored on the [User Program] button (internal memory) on floppy disk as a single set.

1. **Insert the floppy disk into the disk drive.**  
→ For details refer to “Inserting and Ejecting a Floppy Disk” (p. 39).
2. **Press the [User Program] button.**
3. **Touch <Disk>.**



4. **Touch <Save>.**  
The following screen will appear.

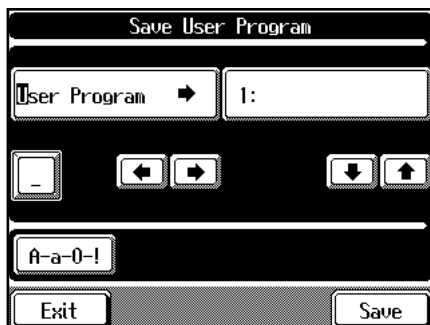

5. **Touch [Left Arrow] and [Right Arrow] to scroll the cursor sideways, and enter the name of the button by using the Value [-] [+] buttons or the dial to choose the letters.**

Touch <A-a-0-!> at the bottom of the screen to change the type of script.

Each touch of <A-a-0-!> cycles the type of characters through “English (upper case),” “English (lower case),” “numerals,” “symbols,” then back to “English (upper case).”

To delete the character under the cursor, touch <->.

6. **After you’ve entered a name, touch [Up Arrow] [Down Arrow] to choose a destination for saving the User Program.**  
\* If you save a User Program at a place where another User Program has already been saved, the previously saved User Program is erased and the new one is saved.  
Touch <Exit> to go back to the previous screen.
7. **Touch <Save> to start saving.**  
→ You can erase a User Program saved on a floppy disk. Take a look at “Erasing a User Program Saved on a Floppy Disk” (p. 141).  
\* Don’t take the floppy disk out of the disk drive until the saving process is finished.

## Calling Up Saved User Programs from Floppy Disk

You can call up an entire set of User Programs saved on floppy disk to the [User Program] button.

\* Please note that calling up User Programs from floppy disk erases all User Programs stored at the [User Program] button.

1. **Insert the floppy disk into the disk drive.**  
→ For details refer to “Inserting and Ejecting a Floppy Disk” (p. 39).
2. **Press the [User Program] button.**
3. **Touch <Disk>.**
4. **Touch <Load>.**  
The following screen will appear.



5. **Touch the screen to select the User Program set you want to call up.**
6. **Touch <Load> at the bottom of the screen.**  
The User Program saved on a floppy disk will be loaded to the [User Program] button (internal memory).

## ■ Erasing a User Program Saved on a Floppy Disk

You can erase an entire set of User Programs saved on a floppy disk.

1. **Insert the floppy disk into the disk drive.**  
→ For details, refer to “Inserting and Ejecting a Floppy Disk” (p. 39).

2. **Press the [User Program] button.**

3. **Touch <Disk>.**

A screen like the one shown below appear.



4. **Touch <Delete> on the screen.**

The following screen will appear.



5. **Touch ↑ ↓ to choose the User Program you want to erase.**

6. **Touch <Delete> on the screen.**

The following screen will appear.



7. **Touch <OK>.**

The selected User Program is erased.  
Touching <Cancel> takes you back to the previous screen without deleting the User Program.

## Disabling Everything Except Piano Play (Panel Lock)

Making the setting for the panel lock enables a state where only piano play is possible, and all buttons are disabled. Even if the buttons are pressed mistakenly, such as might be the case with children, no unwanted settings or changes will result.

\* When the panel is locked, only Grand Piano sounds are played.

1. **Turn down the volume all the way.**

2. **Press the [Power] switch to turn off the power.**

3. **While holding down the [Function] button, press the [Power] switch to turn the power on.**

Then, continue to hold down these two buttons for a few seconds.

4. **Adjust the volume.**

All buttons except for piano play are disabled.

When you play the keyboard Grand Piano tone is played.

By turning the power off and then on once again, the keyboard returns to its normal status with Panel Lock cancelled.

# Chapter 8 Changing Various Settings

## Changing the Settings for One Touch Piano

You can change settings related to the piano performance in the Piano Customize screen.

These settings remains in effect until you turn off the power. At the Piano screen (p. 50), touch <Customize> to display the screen shown below.

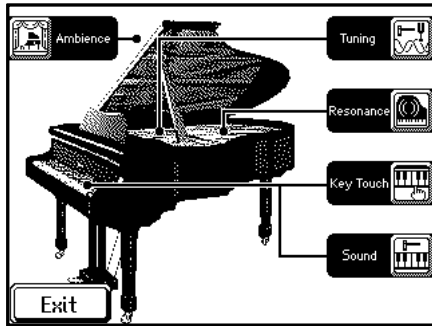

This is called the Piano Customize screen.

You can make the settings for an item by touching the corresponding icon.

Indication	Description
<b>Ambience</b>	This lets you enjoy the atmosphere of performance in a wide variety of different locations.
<b>Tuning</b>	Changes the tuning of the piano.
<b>Resonance</b>	Adjusts the Sympathetic Resonance.
<b>Key Touch</b>	Adjusts the “touch,” or response of the keys.
<b>Sound</b>	This lets you make more detailed adjustments to the piano’s tone.

### ○ What’s Sympathetic Resonance?

When you depress the damper pedal on an acoustic piano, the sound from the strings that were struck resonates with other strings, adding rich reverberations and broadness to the sound. This resonance is called “Sympathetic Resonance.”

## ■ Adding Ambience from Different Venues to Songs (Ambience)

You can savor the same atmosphere as experienced when performing in a concert hall, studio and other venues.

1. At the Piano Customize screen, touch <Ambience>.

The following screen will appear.

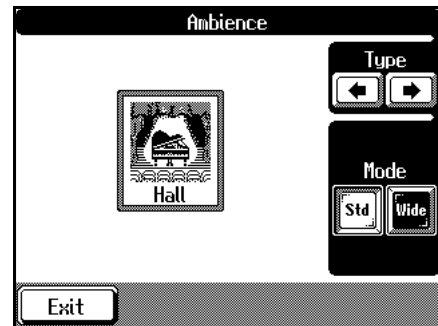

2. Touch the ◀ and ▶ icon to select the type of performance space.

Indication	Description
<b>Ground</b>	On a large open ground
<b>Room</b>	In a small room
<b>Lounge</b>	A large room
<b>Studio</b>	A recording studio
<b>Gymnasium</b>	In a gymnasium
<b>Hall</b>	Concert hall
<b>Dome</b>	A domed ballpark
<b>Cave</b>	In a cavern

3. Touch the “Mode” icon to select the size of performance space.

Indication	Description
<b>Std</b>	This is the normal condition.
<b>Wide</b>	Provides an effect simulating the sound as it would be perceived in a larger, wider space.

Touch <Exit> to go back to the Piano Customize screen.

\* When you change the <Ambience> setting in the Piano Customize screen, the way in which reverb is applied may change.

## ■ Changing the Tuning

### Choosing the Tuning

You can play classical music such as baroque pieces using their original tuning.

Most modern songs are composed and played with the assumption that equal temperament (the most common tuning in use today) will be used, but when classical music was composed, there were a wide variety of other tuning systems in existence. Playing a composition with its original tuning lets you enjoy the sonorities of the chords that the composer originally intended.

1. At the Piano Customize screen (p. 142), touch <Tuning>.

The following screen will appear.



2. Touch any one of the icons to choose the tuning system.

You can choose from among the eight tunings described below.

Tuning system	Characteristics
<b>Equal</b>	This tuning divides an octave into 12 equal parts. Every interval produces about the same amount of slight dissonance. This setting is in effect when you turn on the power.
<b>Just Major</b>	This scale eliminates dissonance in fifths and thirds. It is unsuited to playing melodies and cannot be transposed, but produces beautiful chords.
<b>Just Minor</b>	The scales of the major and minor just intonations are different. You can get the same effect with the minor scale as with the major scale.
<b>Arabic</b>	This scale is suitable for Arabic music.
<b>Kirnberger</b>	This scale is a modification of the meantone and just intonations that permits greater freedom in transposition to other keys. Performances are possible in all keys (III).

<b>Mean Tone</b>	This scale makes some compromises in just intonation, enabling transposition to other keys.
<b>Pythagorean</b>	This scale devised by the philosopher Pythagoras eliminates dissonance in fourths and fifths. Dissonance is produced by third-interval chords, but melodies are euphonious.
<b>Werckmeister</b>	This is a combination of the mean tone and Pythagorean scales. Performances are possible in all keys (first technique, III).

3. Touch to choose the keynote.

When playing with tuning other than equal temperament, you need to specify the ground note for tuning the song to be performed (that is, the note that corresponds to C for a major key or to A for a minor key).

If you choose an equal temperament, there's no need to select a keynote.

### Changing the Tuning Curve

A piano is generally tuned to a pitch with a lower bass range and a higher treble range than equal temperament. This special tuning method for pianos is called "Stretch Tuning." A graph that shows the changes in pitch of actual tuning compared with the changes in equal temperament pitch is called a tuning curve. Changing the tuning curve produces subtle variations in the reverberations of the chords you play.

1. Touch the <Stretch Tuning> icon to choose the tuning curve.

Display	Characteristics
<b>ON</b>	This tuning curve expands the bass and treble ends somewhat (Stretch Tuning). It is suitable for performances such as piano solos. This setting is in effect when you turn on the power.
<b>OFF</b>	This is the standard tuning curve. It is suitable when playing layered tones, or for playing in ensemble with other instruments.

Touch <Exit> to go back to the Piano Customize screen.

### ■ Adjusting Resonance

You can adjust this resonance (Sympathetic Resonance) when the damper pedal is depressed.

1. At the Piano Customize screen (p. 142), touch **<Resonance>**.

The following screen will appear.

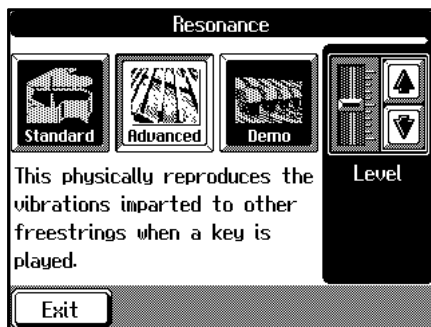

2. Touch the **<Standard>**, **<Advanced>**, or **<Demo>** icon to choose the type of resonant sound.

Indication	Description
<b>Standard</b>	This replicates the resonance inside a piano.
<b>Advanced</b>	This physically reproduces the vibrations imparted to other free strings when a key is played, so it can give you the same feel as the reverberations of an acoustic piano.
<b>Demo</b>	In addition to the effects of Advanced, this also replicates the noise when you depress the pedal.

3. Touch **↑** **↓** to adjust the amount of Resonance Sound.

Touching **↑** intensifies the effect; touch **↓** to reduce the amount of effect.

Touch **<Exit>** to go back to the Piano Customize screen.

\* If you use the Voice Transformer (p. 44) or the Harmonist (p. 46), the resonant sound may sometimes be reset to its original value.

→ When you've chosen **<Demo>**, touching **<Exit>** changes the setting for resonant notes to **<Advanced>**.

### ■ Changing Key Touch (Key Touch)

You can vary the touch of the keyboard when you finger the keys.

1. At the Piano Customize screen (p. 142), touch **<Key Touch>**.

The following screen will appear.

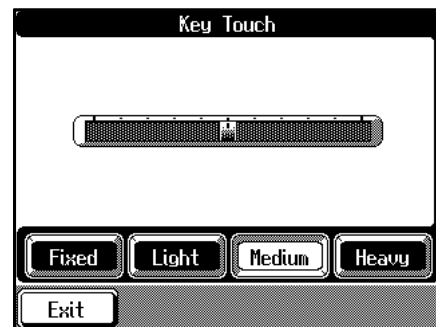

2. Touch the **<Fixed>**, **<Light>**, **<Medium>**, or **<Heavy>** icon to make the setting for keyboard touch.

Indication	Description
<b>Fixed</b>	Notes are sounded at an unchanging volume level, regardless of how lightly or forcefully you finger the keyboard.
<b>Light</b>	This sets the keyboard to a light touch. You can achieve fortissimo (ff) play with a less forceful touch than usual, so the keyboard feels lighter. This setting makes it easy to play, even for children.
<b>Medium</b>	This sets the keyboard to the standard touch. You can play with the most natural touch. This is the closest to the touch of an acoustic piano.
<b>Heavy</b>	This sets the keyboard to a heavy touch. You have to finger the keyboard more forcefully than usual in order to play fortissimo (ff), so the keyboard touch feels heavier. Dynamic fingering adds even more feeling to what you play.

3. To make fine adjustments, touch the bar graph.

The on-screen bar graph shows the keyboard touch.

Touch **<Exit>** to go back to the Piano Customize screen.



## ■ Fine Adjustment of the Piano Tone

You can make more detailed adjustments to the piano's tone.

1. At the Piano Customize screen (p. 142), touch <Sound>.

The following screen will appear.



2. Touch the icons on the screen to adjust the piano sound.

Indication	Description
<b>Dynamic Range</b>	Adjusts the range of change in the tone made in response to velocity, or the force with which the keys are played. Select " <b>Wide</b> " to widen the dynamic range of the sound; select " <b>Narrow</b> " to narrow the dynamic range.
<b>Brightness</b>	Allows you to change the brightness of the piano tone. Select " <b>Bright</b> " to brighten the sound; select " <b>Dark</b> " to make the sound darker.
<b>Release</b>	Sets the length of decay of the sound after the keys are released. Select " <b>Long</b> " to lengthen the sound's release time; select " <b>Short</b> " to shorten the sound's release.

Touch <Exit> to go back to the Piano Customize screen.

## Changing the Settings for Automatic Accompaniment

You can change a variety of settings for automatic accompaniment.

Touch <Options> at the bottom right of the Basic screen (p. 19) to display the setting screen.

The following screen like the one is called "Arranger Option screen."

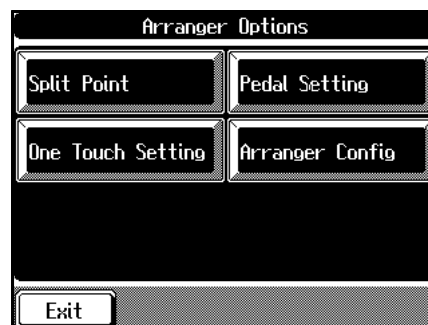

## ■ Changing the Keyboard's Split Point

You can change the location where the keyboard is divided (the split point).

The setting is at "F#3" when the piano is powered up.

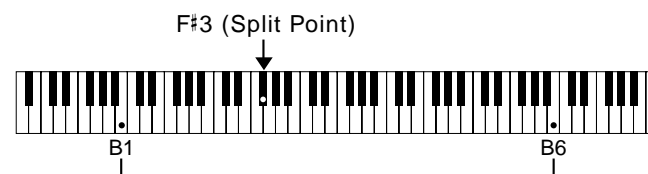

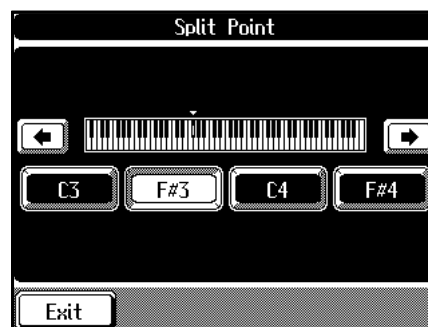

1. Press the One Touch Program [Arranger] button to display the Basic screen.
2. Touch <Options> at the bottom right of the screen.
3. Touch <Split Point> to display the screen shown below.



4. Touch <C3>, <F#3>, <C4> or <F#4>.

The key you chose becomes the split point.

→ The key you chose for the split point belongs to the left-hand section of the keyboard.

5. To make another key the split point, touch   to move the cursor on screen.

You can set the split point within a range of B1 to B6.

Touch <Exit> to go back to the Arranger Option screen.

→ See “Playing Different Tones with the Left and Right Hands (Split Play)” (p. 55).

### ■ Changing How the Automatic Accompaniment Plays

You can set it the setting so that instead of sounding all the parts of a Music Style, only the Music Style’s rhythm part, chord tone, and bass tone are played.

1. Press the One Touch Program [Arranger] button to display the Basic screen.
2. At the Basic screen, touch <Options> at the bottom right of the screen.
3. Touch <Arranger Config.> to display a screen like the one shown below.

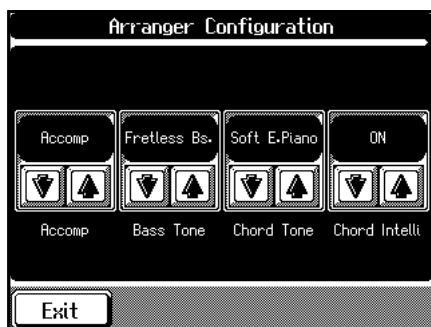

4. Use <Accomp>   to choose the tone you want to play.

Indication	Description
<b>Accomp</b>	Sounds all Parts of the Music Style.
<b>Chord&amp;Bs</b>	Only the Music Style’s rhythm part, chord tone, and bass tone are sounded.

Touch <Exit> to go back to the Arranger Option screen.

→ For more on Chord Tones and Bass Tones, refer to the section “Changing the Chord Tone and Bass Tone,” which follows.

### ■ Changing the Chord Tone and Bass Tone





You can change the sound of the chord tone and bass tone.

#### What Are the Chord Tone and Bass Tone?

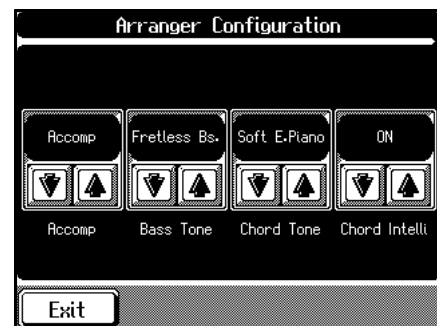
When automatic accompaniment is stopped and the [Sync/Reset] button’s indicator is dark, fingering the left-hand section of the keyboard causes a chord to be sounded. This is called the “chord tone,” and the root of the chord that is played at the same time is called the “bass tone.”

1. Press the One Touch Program [Arranger] button to display the Basic screen.
2. At the Basic screen, touch <Options> at the bottom right of the screen.
3. Touch <Arranger Config.> to make the following screen appear in the display.



4. Touch   of <Bass Tone> to choose the Bass Tone, and touch   of <Chord Tone> to choose the Chord Tone.

When “OFF” is selected, the bass tone or chord tone sound is muted.

Tone	Available tones
<b>Bass Tone</b>	OFF, Acoustic Bs., A.Bass + Cymb1, Fingered Bs., Picked Bs., Fretless Bs., Slap Bass, Organ Bass, SynthBass101, Thum Voice
<b>Code Tone</b>	OFF, E.Piano 1, E.Piano 2, Soft E.Piano, Hard E.Piano, Slow Strings, Strings, Choir, Doos Voice

Touch <Exit> to go back to the Arranger Option screen.

## ■ Canceling the Chord Intelligence Function

The Chord Intelligence function (p. 68) is the function in Automatic Accompaniment that instantly recognizes the accompaniment chord that is to be played, merely when you press the key specifying the chord (the root). Although the Chord Intelligence function is normally turned on when you press the One Touch Program [Arranger] button and have Automatic Accompaniment play, you can turn off the Chord Intelligence function in the following screen.

1. Press the One Touch Program [Arranger] button to display the Basic screen.
2. At the Basic screen, touch <Options> at the bottom right of the screen.
3. Touch <Arranger Config.> to make the following screen appear in the display.

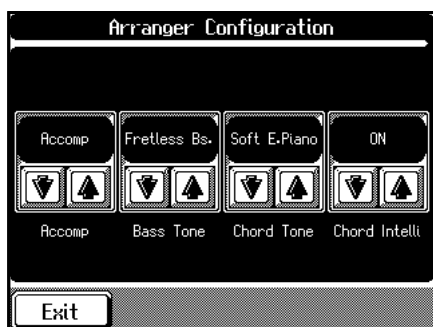

4. Touch the <Chord Intelli>   to select "ON" or "OFF."

Indication	Description
ON	The Chord Intelligence function can be used.
OFF	The Chord Intelligence function cannot be used. You have to finger all the keys to specify the chord.

Touch <Exit> to go back to the Arranger Option screen.

## ■ Keeping the Same Tone and Tempo When the Music Style Changes

Normally, when you select a Music Style, the default setting has the tone in the right hand and the tempo selected automatically. This setting prevents the tempo and tone from changing, even when the Music Style is changed. All items are set to ON when you turn on the power.

1. Press the One Touch Program [Arranger] button to display the Basic screen.
2. At the Basic screen, touch <Options> at the bottom right of the screen.

3. Touch <One Touch Setting> to display a screen like the one shown below.

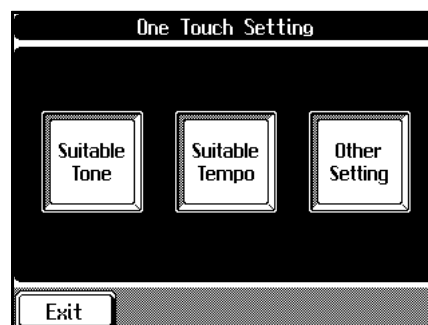

4. Touch the icons to switch On/Off. This feature is on when the icon has a white background, and off when the background is black.

Indication	Description
Suitable Tone	The suitable tone for a Music Style will be selected automatically.
Suitable Tempo	The suitable tempo for a Music Style will be selected automatically.
Other Setting	Other settings (Style Orchestrator settings, Phrase, etc.) are changed automatically.



The parameters that are turned off do not change, even when the Music Style is changed. Touch <Exit> to go back to the Arranger Option screen.

## ■ Assigning Functions to Pedals

You can assign a variety of different functions to the soft pedal and the sostenuto pedal. You can then call up the assigned feature simply by pressing the corresponding pedal.

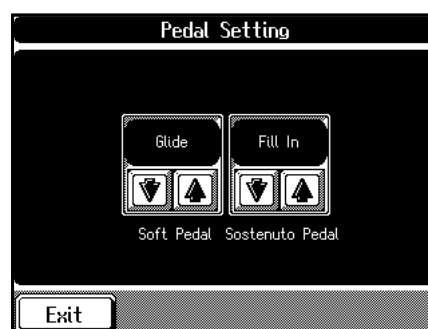
1. Press the One Touch Program [Arranger] button to display the Basic screen.
2. At the Basic screen, touch <Options> at the bottom right of the screen.
3. Touch <Pedal Setting> to display a screen like the one shown below.



4. Touch   to assign the function to the desired pedal. Touch <Exit> to go back to the Arranger Option screen.

## Chapter 8 Changing Various Settings

### ○ Assignable Functions

Indication	Description
<b>Leading Bass</b>	Toggles the Leading Bass function on or off. It is turned on while you depress the pedal.
<b>Break</b>	During a performance with automatic accompaniment, you can stop the accompaniment for exactly one measure.
<b>Fill In to Variation</b>	This does the same thing as the Fill In [To Variation] button (p. 77).
<b>Fill In to Original</b>	This does the same thing as the Fill In [To Original] button (p. 77).
<b>Fill In</b>	A fill-in is inserted, but the accompaniment pattern after that doesn't change.
<b>Half Fill In Variation</b>	This play a fill-in half a measure long, then switches to the Variation accompaniment pattern.
<b>Half Fill In Original</b>	This plays a fill-in half a measure long, then switches to the Original accompaniment pattern.
<b>Original/Variation</b>	This changes the accompaniment pattern without inserting a fill-in.
<b>Arranger Reset</b>	Using this function while Automatic Accompaniment is in use returns the accompaniment to the start of the Division.
<b>Intro 1/Ending 1</b>	This does the same thing as the Intro/Ending [1] button (p. 74).
<b>Intro 2/Ending 2</b>	This does the same thing as the Intro/Ending [2] button (p. 75).
<b>Arranger Start/Stop</b>	This does the same thing as the [Start/Stop] button (p. 74).
<b>Orchestrator Up</b>	This changes the automatic accompaniment to a more florid arrangement.
<b>Orchestrator Down</b>	This changes the automatic accompaniment to a simpler arrangement.
<b>Melody Intelligence</b>	This toggles the Melody Intelligence function on and off (p. 79).
<b>Fade In/Out</b>	This starts automatic accompaniment with a fade-in (where the volume gets progressively louder), ends it with a fade-out (where the volume gets progressively softer), then stops.
<b>Rotary Slow/Fast</b>	This switches the speed of the rotary effect (p. 180).

<b>Glide</b>	The sound's pitch is temporarily lowered while the Glide pedal is pressed; when the pedal is released, the pitch gradually returns to normal. This can be effective for simulating the performance of instruments like a Hawaiian guitar.
<b>Composer Play/Stop</b>	This does the same thing as the Play [▶] button and the Stop [■] button.
<b>Punch In/Out</b>	During Punch-in Recording, this starts and stops recording (p. 117).
<b>Tap Tempo</b>	This sets the tempo according to the timing with which you tap the button (p. 86).
<b>Upper Soft</b>	The pedal in the left functions the Soft pedal (p. 16).
<b>Upper Sostenuto</b>	The pedal in the middle functions the Sostenuto pedal (p. 16).
<b>Lower Damper</b>	This applies lingering reverberations to notes played with the left-hand section of the keyboard while the damper pedal is depressed.
<b>Bend Up</b>	This raises the pitch of notes you play on the keyboard.
<b>Bend Down</b>	This lowers the pitch of notes you play on the keyboard.

### What is the Leading Bass function?

The function that sounds the lowest note of a fingered chord as the bass tone is called "Leading Bass." When set to "ON," the bass tone changes when an inverted chord is used. Usually the tonic of the fingered chord is sounded as the bass tone.

- If you've assigned "Leading Bass" to a pedal, the Leading Bass function is active while you depress the pedal.
- When the "Bend Up" or "Bend Down" function is used with Split (p. 55) selected, the pitch of the sounds played in the right hand are then altered. Additionally, the maximum degree of change in the pitch when the Bender effect is used is called the "Bend Range." Take a look at "Changing the Bend Range" (p. 152).

### What's the Bend Range?

The effect of smoothly raising or lowering the pitch of a played note is known as the "Bender Effect," and the pitch's range of change is called the "Bend Range." With the KF-90, you can apply the bender effect by depressing and releasing a pedal.

- \* Pressing the One Touch Program [Piano] button returns the pedals to their original functions (p. 16).

## Changing the settings for Score screen

You can set which parts are displayed, and how the scores are to be displayed.

**1. Press the [Song/Disk] button.**

A Song/Disk screen appears.

**2. Touch <Score>.**

The score screen appears (p. 84).

**3. Touch <Option> at the bottom of the screen.**

The following screens appears.

This screen consists of two pages. Use Page < ◀ ▶ > to change pages.



Display	Value	Description
Pitches	C,D,E	Letter names (fixed do) are displayed in the detailed score.
	Do,Re,Mi	Solmization syllables (movable do) are displayed in the detailed score.
	Off	Not displayed
Clef L	Auto	Changes automatically
	G Clef	Display the G-clef staff of the left-hand part
	F Clef	Display the F-clef staff of the left-hand part
Clef R	G Clef	Display the G-clef staff of the right-hand part
	F Clef	Display the F-clef staff of the right-hand part
	Auto	Changes automatically
Key	Auto	Display automatically
	b x 5-0-# x 6	Display the score in the selected key

Display	Value	Description
Lower Part	Lower Track, 1-16	Select the part to be displayed as the left-hand part. The power-up default is "Lower Track."
Upper Part	Upper Track, 1-16	Select the part to be displayed as the right-hand part. The power-up default is "Upper Track."
User Part	Whole Track, 1-16	Select the part used for recording your performance. The power-up default is "Whole Track."

**4. Touch [Up] [Down] to set each setting.**

Touch <Exit> to go back to the Score screen.

## Changing the Tone Set When Playing Back a Song

When playing back song data, the data is normally set to be played back using GS tones (tones compatible with other GS devices). By changing the settings, you can play back portions of the data using tones particular to the KF-90.

**1. Press the [Composer Navigator] button.**

The Composer Navigator screen appears.

**2. Touch <Play Mode>.**

The following screen appears.

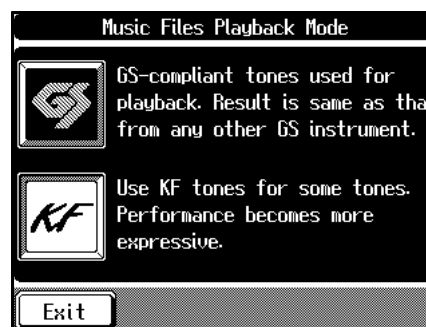

**3. Touch an icon to select the setting.**

Display	Description
GS	Playback uses GS-compatible tones. Result is same as that from any other GS instrument.
KF	Playback will use KF tones for some tones. This will make the performance more expressive. However when the data is played back on non-KF models, the nuances of the performance may be different.

Touch <Exit> to go back to the Function screen.

### Changing the Settings for the Marker and the Count Sound

You can set markers at points within measures and change the sound used with the CountIn feature. To change these settings, use the following procedure to bring up the “Marker Option Screen.”

1. Press the [Composer Navigator] button.  
The Composer Navigator screen appears.
2. Touch <Marker/Count In>.  
The Marker/Count In Screen (p. 90) appears.
3. At the Marker screen, touch <Option> at the bottom right of the screen.  
The following screen will appear.

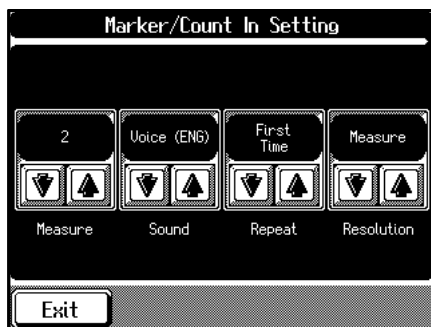

This is called the “Marker Option screen.”  
Touch <Exit> to go back to the Marker screen.

#### ■ Changing the Number of Measures Counted and the Count Sound

When you’ve made the setting for sounding an audible count (p. 88), you can change the number of measures that are counted, as well as the type of counting sound.

1. Display the Marker Option screen.
2. Use <Measure> to choose the number of measures to count and the count sound.

Indication	Description
1	The one-bar count will sound.
2	The two-bar count will sound.

3. Use <Sound> to choose the count sound.

Indication	Description
Sticks	Sound of tapping with a stick
Click	A bell and a clicking sound
Electronic	Electronic sound

Voice(JP)	A voice counting “1, 2” in Japanese
Voice(ENG)	A voice counting “1, 2” in English
Wood Block	Wood Block
Triangle/Castanet	Triangle and castanet sound
Handclap	Clapping
Animal	Animal Voice

Touch <Exit> to go back to the Marker screen.

→ Take a look at “Counting Down Before a Performance Starts” (p. 88).

#### ■ Playing the Count Sound at Each Repetition

You can choose whether the count is sounded at every repetition when you repeat playback of a song or a particular passage.

1. Display the Marker Option screen.
2. Select the way this is to be played with the <Repeat> .

Indication	Description
First Time	The count is sounded only before the first playback.
Every Time	The count-in is sounded each time the song is played.

Touch <Exit> to go back to the Marker screen.

→ Take a look at “Counting Down Before a Performance Starts” (p. 88).

#### ■ Placing a Marker in the Middle of a Measure

A marker is normally placed at the start of the selected measure, but you can also set it so that a marker is placed at a position partway through a measure.

1. Display the Marker Option screen.
2. Touch <Resolution> to choose the marker setting.

Indication	Description
Measure	This lets you place a marker at the beginning of the measure.
Beat	This lets you place a marker at each beat.

Touch <Exit> to go back to the Marker screen.

\* When “Beat” is selected for this setting, place the markers while the song is played back.

→ Take a look at “Placing/Erasing a Marker Within a Song” (p. 90).

## Adjusting the Standard Pitch (Master Tuning)

The standard pitch generally refers to the pitch of the note that's played when you finger the middle A key. For a cleaner ensemble sound while performing with one or more other instruments, ensure that each instrument's basic pitch is in tune with that of the other instruments. This tuning of all the instruments to a standard pitch is called "Master Tuning."

### 1. Press the [Function] button.

The Function screen appears.

### 2. Touch <System Setting>.

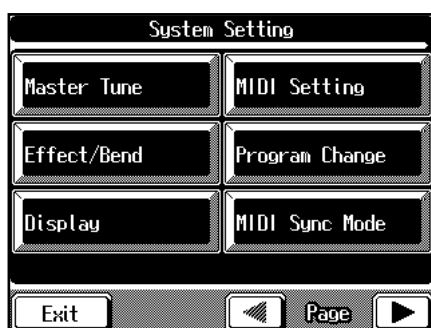

### 3. Touch <Master Tune>.

If <Master Tune> is not displayed, touch Page < ◀ > and < ▶ > to switch screens.



### 4. Touch to change the standard pitch.

The standard pitch can be set to any value from 415.3–466.2 Hz. The setting is at "440.0 Hz" when the piano is powered up.

Touch <Exit> to go back to the Function screen.

## Changing the Type of Reverb Effect

By changing the reverberations of the notes, you can enjoy the atmosphere of performance in a wide variety of different locations.

### 1. Press the [Function] button.

The Function screen appears.

### 2. Touch <System Setting>.

### 3. Touch <Effect/Bend>.

If <Effect/Bend> is not displayed, touch Page < ◀ > and < ▶ > to switch screens.

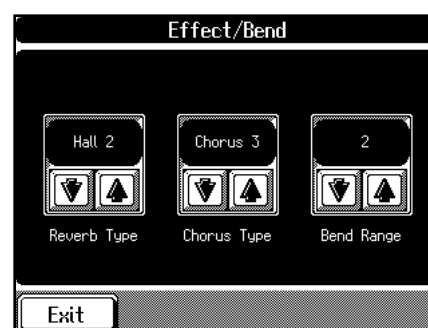

### 4. Touch <Reverb Type> to change the type of reverb.

Display	Type Description
Room 1	Simulates the reverb of a conference room
Room 2	Simulates the reverb of a performance lounge
Room 3	Simulates the reverb of a large, open room
Hall 1	Simulates the reverb of a large concert hall
Hall 2	Simulates the reverb of a small concert hall
Plate	Applies a bright, metallic reverb
Delay	Repeats the sound many times, like an echo
Panning Delay	Makes the sound jump back and forth between the left and right speakers

Touch <Exit> to go back to the Function screen.

\* *Changing the type of Reverb effect may also change the setting for "Adding Ambience from Different Venues to Songs (Ambience)" (p. 142).*

→ *Check out "Adding Reverberation to Sounds (The Reverb Effect)" (p. 59).*

### Changing the Type of Chorus Effect

When the “Chorus” effect is applied (p. 62), you can change the chorus effect type.

\* If <Depth> is set to “0” when the “Chorus” effect is selected in the Effect Screen, the chorus effect is not applied to the sound.

**1. Press the [Function] button.**

The Function screen appears.

**2. Touch <System Setting>.**

**3. Touch <Effect/Bend>.**

If <Effect/Bend> is not displayed, touch Page < ◀ > and < ▶ > to switch screens.

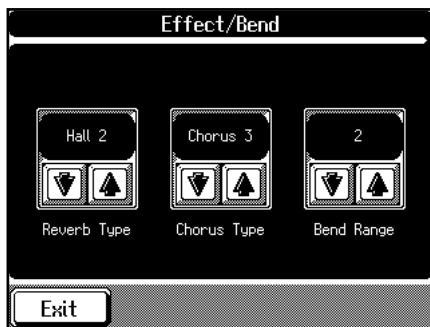

**4. Use <Chorus Type> ↑ ↓ to change the type of chorus effect.**

Display	Type Description
<b>Chorus 1</b>	Applies a light chorus effect with slow undulations
<b>Chorus 2</b>	Applies a light chorus effect with quick undulations
<b>Chorus 3</b>	Applies a deep chorus effect with slow undulations
<b>Chorus 4</b>	Applies a deep chorus effect with quick undulations
<b>Feedback Chorus</b>	A soft sound with a flanger effect
<b>Short Delay</b>	A short echo effect
<b>Flanger</b>	An effect that sounds like a jet plane's ascent/descent
<b>Short Delay (Feedback)</b>	A short echo with many repetitions

Touch <Exit> to go back to the Function screen.

### Changing the Bend Range

The effect of smoothly raising or lowering the pitch of a played note is called the “Bender Effect.”

With the KF-90, you can assign the bender effect to a pedal, then apply the bender by depressing and releasing the pedal (p. 147).

You can also make a setting that determines how much the pitch of the note changes when you apply the bender. The maximum range of change in pitch is called the “Bend Range.”

**1. Press the [Function] button.**

The Function screen appears.

**2. Touch <System Setting>.**

**3. Touch <Effect/Bend>.**

If <Effect/Bend> is not displayed, touch Page < ◀ > and < ▶ > to switch screens.

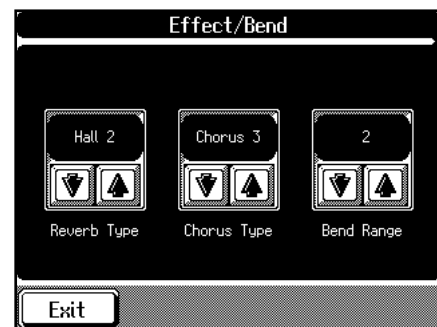

**4. Use <Bend Range> ↑ ↓ to set the bend range.**

You can set this to any value within a range of 1 to 12 (in half-tone steps, up to one octave).

Touch <Exit> to go back to the Function screen.

→ Take a look at “Assigning Functions to Pedals” (p. 147).



## Changing the Screen Settings

Some karaoke Music Files show lyrics on screen. You can hide the on-screen lyrics displayed by such music files. With the KF-90, you can also change the language and vary the contrast of the screen.

### 1. Press the [Function] button.

The Function screen appears.

### 2. Touch <System Setting>.

### 3. Touch <Display/Language>.

If <Display/Language> is not displayed, touch Page <◀> and <▶> to switch screens.



Touch <Exit> to go back to the Function screen.

## ■ Hiding the On-screen Lyrics

\* This setting is enabled only when playing back music files that include the lyrics.

### 1. Touch <Lyric> to choose the setting.

Indication	Description
On	Lyrics are displayed (when performance data containing lyrics is played back).
Off	Lyrics are not displayed.

## ■ Changing the Language

### 1. Use <Language> to choose the language.

Indication: English, Japanese

## ■ Adjusting the Contrast of the Screen

### 1. Touch <Contrast> to adjust the contrast of the screen.

You can adjust the contrast level along a ten-stage range. The higher the value set, the brighter it is displayed.

## Changing the Screen Message When the Power Is Turned On (Opening Message)

You can select the words and other messages you want to have displayed on the KF-90's screen when the power is turned on.

### 1. Press the [Function] button.

The Function screen appears.

### 2. Touch <System Setting>.

### 3. Touch <Opening Message>.

If <Opening Message> is not displayed, touch Page <◀> and <▶> to switch screens.

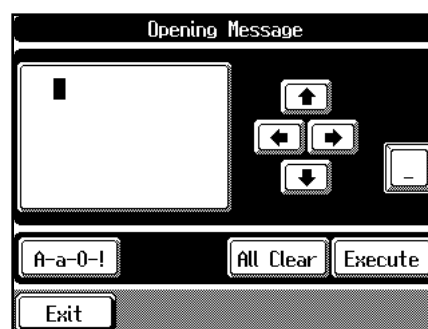

### 4. Use to scroll the cursor, and enter the message by using Value [-] [+] button or the dial to choose the letters.

Touch <A-a-0-!> at the bottom of the screen to change the type of script.

Touching <\_> inserts a blank space at the cursor location.

### 5. When you're done entering the text, touch <Execute>.

Touch <Exit> to go back to the Function screen.

\* Never switch off the power while this operation is in progress. Doing so can damage the internal memory, making it impossible to use this instrument.

→ If you touch <All Clear> at the bottom of the screen, followed by <Execute>, the piano will revert to using its original opening message.

### Maintaining Settings After the Power Is Turned Off (Memory Backup)

Ordinarily, when you turn off the power, settings return to their default values. However, some settings can be stored, so they won't be discarded when you turn off the power. This function is called "Memory Backup."

1. Press the [Function] button.
2. Touch <System Setting>.
3. Touch <Memory Backup>.

If <Memory Backup> is not displayed, touch Page < ◀ > and < ▶ > to switch screens.

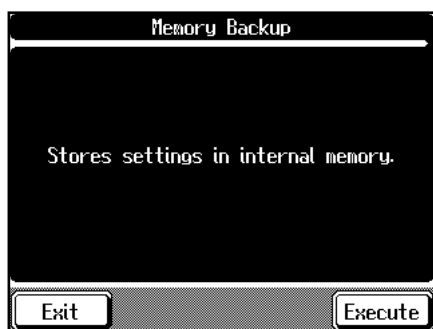

Touch <Exit> to go back to the Function screen.

4. Touch <Execute> on the screen.  
The confirmation message appears on screen.
  5. Touch <OK> to store the settings in memory.  
When the setting has been stored in memory, the previous screen will reappear.  
Touch <Cancel> to make the message disappear without storing the settings.
- \* Never switch off the power while a Memory Backup operation is in progress. Doing so can damage the internal memory, making it impossible to use this instrument.

### Restoring the Factory Settings (Factory Reset)

You can restore the settings stored in memory with "Memory Backup" (p. 154) to these original factory-default values. This function is called "Factory Reset."

- \* When you perform a Factory Reset, all settings that have been stored in memory up to then are erased and reset to their factory defaults.

1. Press the [Function] button.  
The Function screen appears.
2. Touch <System Setting>.
3. Touch <Factory Reset>.

If <Factory Reset> is not displayed, touch Page < ◀ > and < ▶ > to switch screens.

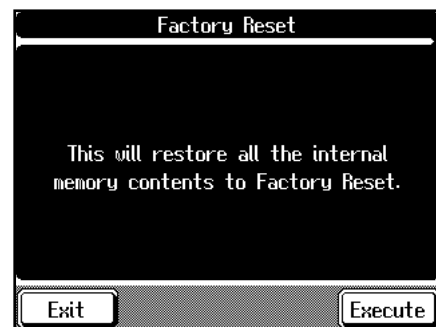

Touch <Exit> to go back to the Function screen.

4. Touch <Execute> on the screen.  
The confirmation message appears on screen.
  5. Touch <OK> to restore the settings to their factory defaults.  
When the setting is changed, the previous screen returns.  
Turn the KF-90 off, then on again.  
Touch <Cancel> to make the message disappear without changing the settings.
- \* Never switch off the power while this operation is in progress! Doing so can damage the internal memory, making it impossible to use this instrument.

## Repositioning the Touch Screen

If you've been using the Touch Screen for some time, the pointer may be shifted, making the KF-90 react incorrectly. You should correct this displacement when necessary by performing calibration (repositioning).

**1. Press the [Function] button.**

**2. Touch <System Setting>.**

**3. Touch <Touch Screen>.**

If <Touch Screen> is not displayed, touch Page < ◀ > and < ▶ > to switch screens.



Touch <Exit> to go back to the Function screen.

**4. Touch <Execute> on the screen.**

**5. Touch the points indicated on the touch screen.**

\* *Do this carefully, because touching a location that's different from the one indicated for the pointer may make the displacement even worse. Be sure to touch the pointer accurately.*

**6. Touch <Memorize> at the bottom of screen to store the setting of calibration to KF-90.**

\* *If you turn the power off before doing step 6, the setting of calibration will go away.*

# Chapter 9 Connecting External Devices

By connecting the KF-90 to external devices such as audio equipment and MIDI instruments, you can enjoy in the following ways.

## ○ Connecting MIDI Devices (p. 156)

You can connect a MIDI sequencer and record performance data from the KF-90 or play performance data from the KF-90 on the sequencer. Also, when you connect a MIDI sound module, you can perform on the KF-90 and hear the sounds played through the MIDI sound module.

## ○ Connecting a Computer (p. 161)

You can use a sequencer program (such as Roland Visual-MT) to record performance data from the KF-90 and play performance data from the program on the KF-90.

## ○ Connecting Audio Equipment (p. 160)

The KF-90 has high-quality built-in stereo speakers, but you can also hook up a stereo system, and enjoy performances that are even more impressive.

You can also connect it to a tape recorder or other recording equipment and record your performances.

## Connecting MIDI Devices

By connecting an external MIDI device and exchanging performance data, you can control the performances on one device from the other. For instance, you can output sound from the other instrument or switch Tones on the other instrument.

### What's MIDI?

MIDI, short for "Musical Instrument Digital Interface," was developed as a standard for the exchange of performance data between electronic instruments and computers. The KF-90 is equipped with MIDI connectors and a Computer connector to let it exchange performance data with external devices. These connectors can be used to connect the KF-90 to an external device for even greater versatility.

- \* A separate publication titled "MIDI Implementation" is also available. It provides complete details concerning the way MIDI has been implemented on this unit. If you should require this publication (such as when you intend to carry out byte-level programming), please contact the nearest Roland Service Center or authorized Roland distributor.

## ■ Connectors

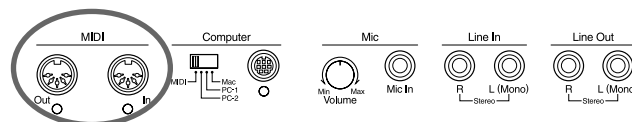

### MIDI Out Connector

Connect this to the MIDI In connector on an external MIDI device using a MIDI cable (sold separately).

Performance data when you finger the keyboard or depress a pedal is sent from this connector to the external MIDI connector.

### MIDI In Connector

Connect this to the MIDI Out connector on an external MIDI device using a MIDI cable (sold separately).

This receives MIDI messages that are sent from external MIDI devices. The KF-90 that receives MIDI messages can output sounds, exchange tones, and perform other operations.

## Making the Connections

\* To prevent malfunction and/or damage to speakers or other devices, always turn down the volume, and turn off the power on all devices before making any connections.

1. Turn the volume all the way down on the KF-90 and on the device you're about to connect.
2. Switch off the power to the KF-90 and the device you're about to connect.
3. Set the Computer switch on the back of the unit to "MIDI."
4. Use a MIDI cable (sold separately) to connect the MIDI connectors to each other.  
Please refer to the connection examples below.
5. Switch on the power to the KF-90 and the connected device.
6. Adjust the volume level on the KF-90 and the connected device.
7. You should also set the MIDI settings as needed.  
For details on the MIDI-related settings, refer to p. 157–p. 159.

### Connecting with MIDI Sequencer

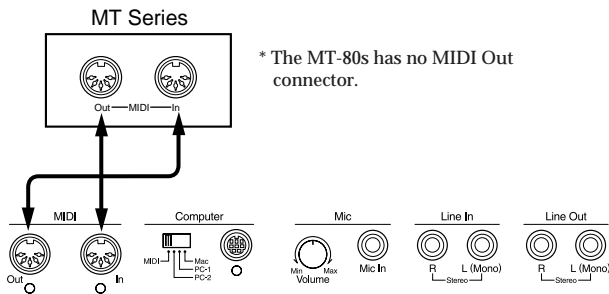

\* The MT-80s has no MIDI Out connector.

\* When the KF-90 is connected to a MIDI sequencer, set it to Local OFF. Refer to "Disconnecting the Keyboard from the Internal Sound Generator (Local On/Off)" (p. 158).

### Connecting with a MIDI Sound Module

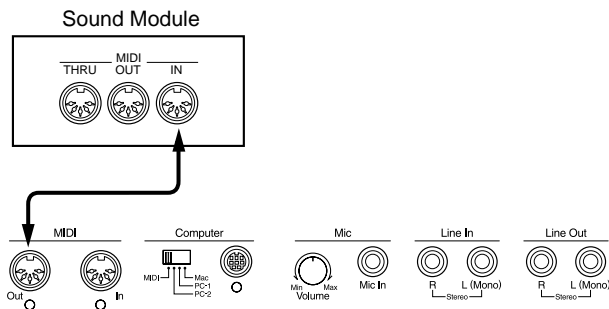

## MIDI Settings

With the KF-90, you can make MIDI settings like those described below.

### "MIDI Setting Screen"

Display	Description
<b>TX. Channel</b>	Chooses the MIDI send channel (p. 158).
<b>Local Control</b>	Switches Local Control on or off (p. 158).
<b>Composer Out</b>	Determines whether a recorded performance is sent to the MIDI instrument. (p. 158)

### "Program Change Screen"

<b>Program Change</b>	Sends Program Change messages (Program Numbers). (p. 158)
<b>Bankselect MSB</b>	Sends Bank Select MSB messages. (p. 158)
<b>Bankselect LSB</b>	Sends Bank Select LSB messages. (p. 158)

## Making the Settings

1. Press the [Function] button.
2. Touch <System Setting>.
3. Touch <MIDI Setting> or <Program Change>.

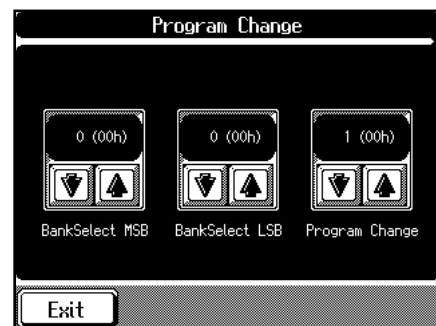
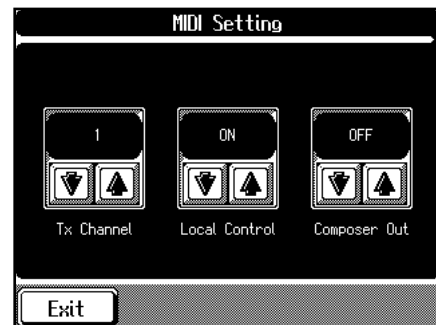

4. Touch to make the setting for the corresponding item.

Touch <Exit> or press the [Function] button to go back to the previous screen.

### ■ Selecting the Transmit Channel (Tx. Channel)

MIDI organizes things into “channels,” which are numbered from 1 through 16. Simply connecting a cable is not enough for communication to take place. The connected devices must be set to use the same MIDI channels. Otherwise, no sound will be produced, and no sounds can be selected.

Select the transmit channel (1–16) of the KF-90.

The channel setting is at “1” when the KF-90 is powered up.

If the keyboard has been split into right-hand and left-hand sections, messages from the left-hand section are not sent.

The KF-90 receives messages on all channels from 1 through 16.

### ■ Disconnecting the Internal Sound Generator and Keyboard (Local Control)

When connecting a MIDI sequencer, set Local Control to “off.” The setting is at “Local Control ON” when the KF-90 is powered up.

As illustrated, information describing what has been played on the keyboard is passed to the sound module over two different routes, (1) and (2). As a result, you hear overlapping or intermittent sounds. To prevent this from happening, route (1) must be severed, by setting the unit to what is known as “Local Off.”

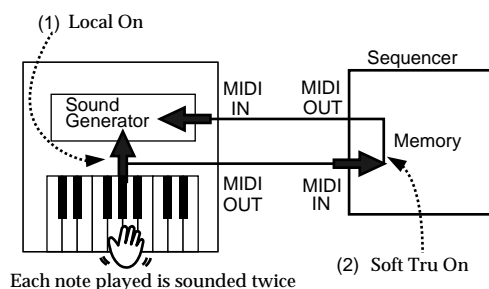

**Local On:** The keyboard and internal sound generator are connected.

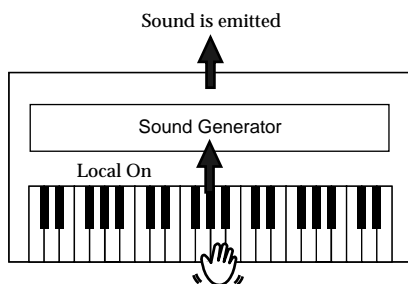

**Local Off:** The keyboard and internal sound generator are separated. No sound will be produced by the keyboard when it is played.

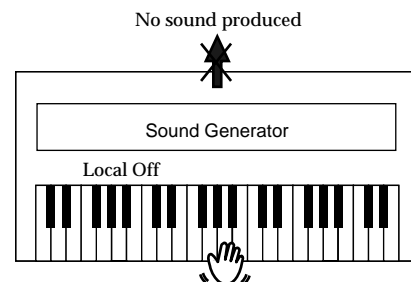

→ When connecting a unit in the Roland MT series, you don't need to switch off Local Control. MT units transmit Local Off messages when their power is switched on. If you first switch on the KF-90, then the MT-series device, Local Control is automatically switched off on the KF-90.

### ■ Sending Recorded Performance Data to a MIDI Device (Composer Out)

When Composer Out is active, you can send performance data recorded with the KF-90 to a connected MIDI device or computer.

When you turn on the power, this is set to “OFF” (data is not sent).

### ■ Sending Tone Change Messages (Program Change/BankSelect MSB/BankSelect LSB)

A Program Change is a message that means “change to the tone of the specified number.” The device that receives this changes to the tone of the corresponding number.

When you choose a Program Change message (Program Number), the Program Number will be transmitted to the MIDI device connected to the KF-90. The MIDI device that receives the Program Number changes the tone to the corresponding Program Number.

Normally, the Tone is selected from the 128 Tones available. Some MIDI devices, however, have more than 128 Tones.

With such devices, the Tone is selected through a combination of Program Change messages and Bank Select messages. There are two parts of a Bank Select message: the MSB (Controller 0, with a value of 0–127) and the LSB (Controller 32, with a value of 0–127).

\* Some MIDI instruments can't handle Bank Select messages. Others can handle Bank Selects, but do not recognize the LSB part.

→ If you want to know more about how sounds are changed upon reception of Program Change messages, please see “MIDI Implementation” (Sold separately).

## Synchronizing with Connected MIDI Devices

You can have connected MIDI devices played by the tempo produced by the KF-90; you can also have the tempo produced by connected MIDI devices play the KF-90. This setting is called the “MIDI Sync.”

Having connected MIDI devices work at the same tempo, and start and stop at the same timing is called “synchronization.”

**1. Press the [Function] button.**

The Function screen appears.

**2. Touch <System Setting>.**

**3. Touch <MIDI Sync Mode>.**

The following screen is appeared.

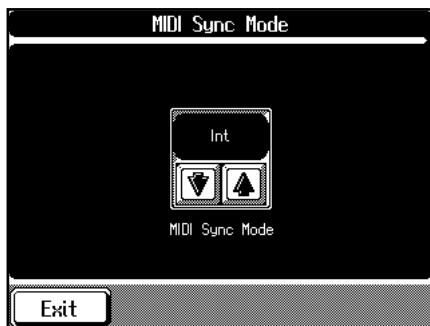

**4. Touch   to make the setting.**

Displayed	Description
<b>Int</b>	Adjustment of the KF-90's tempo and starting and stopping of playback and recording is performed by the KF-90.
<b>Ext</b>	The KF-90's tempo as well as the starting and stopping of playback and recording is controlled by the MIDI device connected to the KF-90's MIDI In connector. When there is no MIDI device connected, then tempo changing operation can not be controlled by the KF-90.
<b>Remote</b>	Playback and recording of songs is controlled by the connected MIDI device.
<b>Auto</b>	The KF-90's tempo as well as the starting and stopping of playback and recording is controlled by the MIDI device connected to the KF-90's MIDI In connector. When there is no MIDI device connected, then these operations can be performed by the KF-90.

\* Unless the above is set to either “Int” or “Auto,” the KF-90's buttons cannot be used to adjust the KF-90's tempo. Ordinarily, you should set this to “Int.”

Touch <Exit> to go back to the Function screen.

## MIDI Ensemble

Performing in Ensemble with MIDI Instruments (MIDI Ensemble)

You can connect an electronic percussion device or other such MIDI instrument to the KF-90's MIDI In connector to allow ensemble playing. Making the MIDI settings for the instrument connected to the MIDI In connector is easy. The sounds from the connected MIDI instrument are played from the KF-90's speaker.

**1. Press the [Function] button.**

The Function screen appears.

**2. Touch <System Setting>.**

**3. Touch <MIDI Ensemble>.**

The following screen is appeared.



**4. Select the method for using the MIDI In connector.**

Displayed	Meaning
<b>Normal</b>	Normal setting. Make changes in tone and other settings from the connected device.
<b>Pad</b>	Choose this when a percussion pad (such as the Roland SPD-20 Total Percussion Pad) is connected to the MIDI In connector on the KF-90. You don't need to make any MIDI settings on the KF-90. Make the settings for the pad sounds or others on the pad. (For more information, refer to the pad's manual.)
<b>Keyboard</b>	Choose this when a keyboard (such as the Roland PC-180 or AX-1 MIDI Keyboard Controller) is connected to the MIDI In connector on the KF-90. You can choose the tones played with the connected keyboard on the KF-90.

**5. When “Keyboard” is selected in Step 3 above, use**

** or  to select the tone.**

The connected keyboard plays using the selected tone.

Touch <Exit> to go back to the Function screen.

### Connecting to Audio Equipment

When you connect the KF-90 to audio equipment, you can play the sounds from the KF-90 through the speakers on the audio equipment or record your performances on a tape recorder or other recording device.

When connecting, please use an audio cable with a standard phone plug (sold separately).

#### Connectors

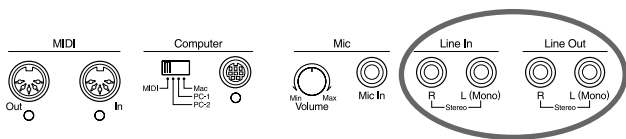

#### Output Jacks

You can connect audio equipment using audio cables (sold separately) and play the sounds from the KF-90 through the speakers on the connected equipment or record your performances on a tape recorder or other recording device. If the input of the connected device is monaural, you must use the L (Mono) jack.

#### Input Jacks

You can connect another sound source, such as audio equipment or an electronic instrument using audio cables (sold separately) and play the sounds from the connected device through the speakers on the KF-90.

If the input of the connected device is monaural, you must use the L (Mono) jack.

#### Making the Connections

*\* To prevent malfunction and/or damage to speakers or other devices, always turn down the volume, and turn off the power on all devices before making any connections.*

#### Playing Sounds from the KF-90 Through the Speakers on Audio Equipment or Recording Your Performances on a Recording Device

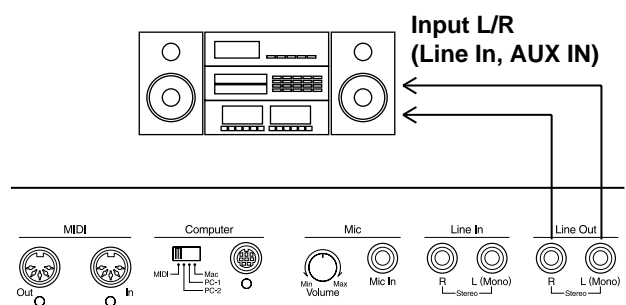

1. Turn the volume all the way down on the KF-90 and on the device you're about to connect.

2. Turn off the power to the KF-90 and other connected equipment.
3. Use audio cables (sold separately) to make the connection.
4. Switch on the KF-90.
5. Switch on the connected device.
6. Adjust the volume level on the KF-90 and the connected device.

Recording KF-90 Performances on a Recording Device

7. Start recording with the connected device.
8. Play the keyboard.
9. When the performance ends, stop recording on the connected equipment.

#### Playing Audio Equipment Sounds Through the Speakers on the KF-90

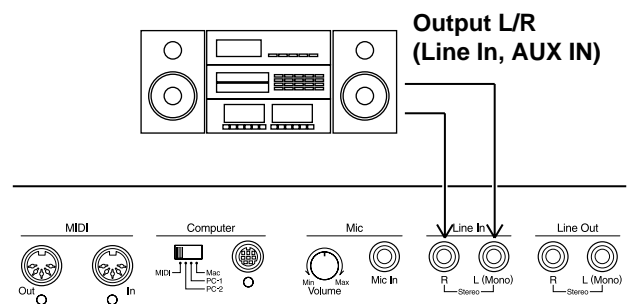

1. Turn the volume all the way down on the KF-90 and on the device you're about to connect.
2. Turn off the power to the KF-90 and other connected equipment.
3. Use audio cables (sold separately) to make the connection.
4. Turn on the connected equipment.
5. Turn on the KF-90.
6. Adjust the volume level on the KF-90 and the connected device.

After use, turn off the power using the following procedure.

1. Turn the volume all the way down on the KF-90 and on the device you're about to connect.
2. Turn off the connected equipment.
3. Turn off the KF-90.



## Connecting a Computer

You can connect a computer on which a sequencing program such as Roland Visual MT is installed and play sounds from the software sound generator through the KF-90's speakers or save songs recorded on the KF-90 on the computer.

### Connectors

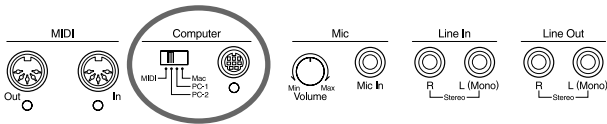

#### Computer Connector

You can connect a computer to this connector to exchange performance data.

Use a computer cable (sold separately) to make the connection.

The type of cable required will depend on your computer.

#### Computer Switch

The setting for this switch is made depending on the computer connected— Mac/PC-1/PC-2.

When this switch is set to MIDI, this connector cannot be used.

### Making the Connections

\* *To prevent malfunction and/or damage to speakers or other devices, always turn down the volume, and turn off the power on all devices before making any connections.*

1. Turn on the KF-90 and the computer.
2. Using a compatible computer cable (sold separately), connect the Computer connector on the back of the keyboard with the computer's serial port.
3. Set the computer switch on the underside of the keyboard to match the type of computer connected.

Please refer to the connection examples below.

\* *Change the setting of the Computer switch only after the power to the unit is off.*

4. Turn on the computer.
5. Turn on the KF-90.
6. Make the settings for baud rate (transmission speed) for the computer and the software.

For more information on this procedure, please refer to the owner's manual for your computer.

7. You should also make the settings for the MIDI send channel (p. 158) and Local Control on or off as needed (p. 158).

#### Connection Examples:

##### ○ Connection with an Apple Macintosh computer

Use a computer cable (sold separately) to connect the Computer connector on the KF-90 to the modem port (or printer port) on the Apple Macintosh. Set the Computer switch to "Mac."

When using the Macintosh "Patch Bay" utility, specify 1 MHz as the Interface Type (MIDI Interface Clock).

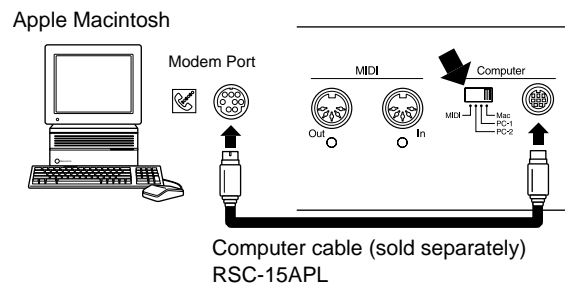

##### ○ Connection with an IBM PC

Use a computer cable (sold separately) to connect the Computer connector on the KF-90 to the COM1 or COM2 serial port on the IBM PC. Set the Computer switch to "PC-2."

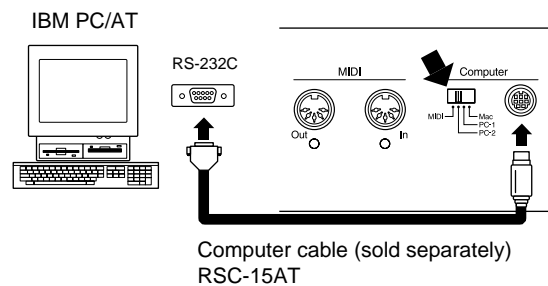

# Trouble Shooting

If you think there's a problem, read this first.

## The power doesn't come on.

- Is the power cord connected and plugged in correctly? (p. 16)

## The button doesn't work.

- Is the panel locked? (p. 141)  
Turn the power off, then back on.

## No sound is heard.

- Has the [Volume] knob been moved all the way to the left? (p. 17)
- Are headphones plugged in? (p. 17)
- Has the [Balance] knob been moved all the way to the "Accomp" or "Keyboard"? (p. 81)
- Has the volume been set to "0" using the Part Balance function? (p. 81)

## No sound is heard (when a MIDI instrument is connected).

- Have all devices been switched on? (p. 156)
- Is the Computer switch on the rear of the KF-90 set to "MIDI"? (p. 156)

## No sound is heard when the keyboard is played.

- Has Local Control been set to "off"? (p. 157)

## Sounds are heard twice (doubled) when the keyboard is played.

- Has the Layer Play mode been enabled? (p. 53)
- When the KF-90 is connected to an external sequencer, set it to the Local OFF mode. Alternatively, the sequencer could be set so its Soft Thru feature is OFF (p. 157).

## Not all played notes are sounded.

- The maximum number of notes that the KF-90 can play simultaneously is 64 (stereo). Frequent use of the damper pedal during automatic accompaniment or when playing along with a song on floppy disk may result in performance data with too many notes, causing some notes to drop out.

## The tuning or pitch of the keyboard or song is off.

- Has the setting for transposition been made? (p. 93, 94)
- Are the settings for the Temperament and tuning curve correct? (p. 143)
- Is the setting for Master Tune correct? (p. 151)

## Effects cannot be applied to Tones.

- It's not possible to apply more than one effect at the same time, so when a performance has been recorded on multiple tracks or when playing along with a song as it's played back, the desired effect may not be applied.

## Automatic accompaniment is not heard.

- Has the [Balance] knob been moved all the way to the

Keyboard? (p. 81)

- Have you pressed the One Touch Program [Arranger] button?  
If the One Touch Program [Arranger] button has not been pressed, only the rhythm pattern is played (p. 73).
- Is the 16-track Sequencer screen displayed (p. 119)?

## Certain instruments are not heard while playing a song.

- Have song settings been changed for each Part (p. 120)?
- Is the track button set so as to mute the sound (black background)?  
Sounds on a track for which the track button is muted (indicated by a black background) are not played. Touch the button to enable play of the sounds (white background) (p. 89).

## A Tone or Music Style cannot be selected.

- Touch <Exit> several times to display the Basic screen (p. 19), then choose the Tone or Music Style.

## There is a slight delay before playback of a song on floppy disk starts.

- There are two types of SMF music data: format 0 and format 1. If the song uses SMF format 1 data, there will be a slight delay until playback starts. Refer to the booklet that came with the music data you're using to determine the format type.

## When song playback starts, the on-screen measure number reads "PU" (pickup).

- If the song starts in the middle of a measure, the display shows "PU" (pickup) at the beginning of the song. After that, the measure number is displayed.

## The Fwd [ >>> ] and Bwd [ <<< ] buttons don't work.

- The fast-forward and reverse buttons are ignored while music data is being read in. Wait until processing finishes.

## Pressing the Reset [ ◀ ] button doesn't return to the beginning of the song.

- Some music data may contain settings that stop play at a point partway through the song. When playing such songs, pressing the Reset [ ◀ ] button moves the song to the point that has been set. Press the button several times more to return to the beginning of the tune.

## The Tone has changed.

- During automatic accompaniment, changing the Music Style automatically changes the Tones and tempo of the upper part of the keyboard to match the new Music Style. If you want to change only the Music Style without also altering the tempo and Tone, check out "Keeping the Same Tone and Tempo When the Music Style Changes" (p. 147).
- When a performance made along with a Music Data tune has been recorded, recording the performance to track button [1/Whole] may make the Tones for buttons [3/Left] and [4/Right] change as well.

## Chord Intelligence can't be used.

- Has Chord Intelligence been switched off? (p. 147)
- Is the setting for "Piano Style Arranger" active? (p. 80)

## A note doesn't stop playing

- Have the Chord Tone and Bass Tone been changed (p. 146)?  
Some Chord Tone and Bass Tone notes may be sounded continuously.

## Recording is not possible.

- Has one of the track buttons for recording been selected? (p. 101)
- Has the setting for "Punch-in Recording" (p. 117) or "Tempo Recording" (p. 123) been made?  
To go back to the usual recording method.

## The recorded performance has disappeared.

- Any performance that has been recorded is deleted when the power to the KF-90 is turned off or a song is selected. A performance cannot be restored once it's been deleted, so be sure to save it on a floppy disk before you turn off the power (p. 109).

## The tempo of the recorded song or metronome is not right.

- When you record after selecting an internal song that features a changing tempo, the tempos on the other tracks are changed in keeping with these tempo changes. In addition, the metronome tempo is also changed the same way.

## Nothing appears on screen.

- The KF-90 uses a liquid-crystal screen, so text may not be displayed when the ambient temperature is below freezing.

## Lyrics are not indicated properly in the display.

- With some music files, the lyrics cannot be displayed correctly.
- Lyrics data can not be saved on a floppy disk.
- If you press a button while the lyrics are being shown in the display, the lyrics will disappear. To recall them, press the Play [▶] button.

## Score is not indicated properly in the display.

- In the Score screen, some lyrics or notes could extend beyond the edges of the screen, and not be displayed.
- The score display feature is particularly unsuitable for the display of difficult, complex musical works that demand accurate notation.  
Refer to "Some notes on a Score Screen" (p. 85).
- If you select a part that does not contain performance data, notes will not be displayed in the score.  
Change the part that is displayed (p. 149).

## The Touch Screen doesn't respond correctly.

- The positioning of the Touch Screen may become displaced if some time has passed since it was last used. Take a look at "Repositioning the Touch Screen" (p. 155) to correct the positioning.

## Depressing a pedal has no effect, or the pedal effect doesn't stop.

- Is the pedal connected correctly? (p. 16)
- Has a different function been assigned to the pedal? See "Assigning Functions to Pedals" (p. 147).
- Normal pedal operation is automatically enabled when the One Touch Program [Piano] button is pressed.
- Unplugging a pedal cord from the unit while the power is on may cause the pedal's effect to be applied without stopping. Be sure to switch off the power to the unit before attempting to disconnect or connect a pedal cord.

## A High-Pitched Whine Is Produced

### ● When listening through headphones:

Some of the more flamboyant and effervescent piano tones feature an ample high-end component, which may make the sound appear to have metallic reverberation added. Since this reverberation becomes particularly audible when supplemented by heavy reverb, you may be able to diminish the problem by reducing the amount of reverb applied to the sound.

### When listening through speakers:

Here, a different cause (such as resonance produced by the KF-90) would be suspect. Consult your Roland dealer or nearest Roland Service Center.

## The Bass Range Sounds Odd, or There Is a Vibrating Resonance

### ● When listening through speakers:

Playing at loud volumes may cause instruments near the KF-90 to resonate. Resonance can also occur with fluorescent light tubes, glass doors, and other objects. In particular, this problem occurs more easily when the bass component is increased, and when the sound is played at higher volumes. Use the following measures to suppress such resonance.

- Place speakers so they are 10–15 cm from walls and other surfaces.
- Reduce the volume.
- Move the speakers away from any resonating objects.

### When listening through headphones:

Here, a different cause (such as resonance produced by the KF-90) would be suspect. Consult your Roland dealer or nearest Roland Service Center.

## Reverberation Still Audible Even with Reverb Turned Off

- Since the KF-90's piano sounds faithfully reproduce the sense of spaciousness and reverberation of an actual acoustic piano's sound, a certain amount of reverberation is still perceptible, even with the reverb effect deactivated.

## The volume level of the instrument connected to KF-90 is too low.

- Could you be using a connection cable that contains a resistor?  
Use a connection cable that does not contain a resistor.

# If this Message Appears on Screen

**Indication: PU**

Meaning: When a song with a pickup (a song that does not start on the first beat) is played back, the measure numbers will be indicated in the display as PU, 1, 2, and so forth.

**Indication: Error.00**

Meaning: To protect the copyright, this music file cannot be saved as an SMF. Also, the music file can not be saved. If you want to save it, please save on the same floppy disk.

**Indication: Error.01**

Meaning: You can only read the music file or music style. It can not be saved on a floppy disk or internal memory.

**Indication: Error.02**

Meaning: The protect tab on the floppy disk is set to the Protect position. Change it to the Write position. Repeat the procedure.

**Indication: Error.03**

Meaning: This floppy disk cannot store the format or save any data. Insert a different disk and repeat the procedure.

**Indication: Error.04**

Meaning: The data cannot be saved onto this floppy disk because the format is different. Use the floppy disk in the same format.

**Indication: Error.05**

Meaning: A new song cannot be written on this song. Select a different song number or use a different floppy disk, and repeat the procedure.

**Indication: Error.10**

Meaning: No floppy disk is connected to the disk drive. Insert the disk correctly, and repeat the procedure.

**Indication: Error.11**

Meaning: There is not sufficient space left on the floppy disk or internal memory for the data to be saved. Save the data onto a different floppy disk.

**Indication: Error.12**

Meaning: The floppy disk inserted into the disk drive can't be read. Be sure you're using Roland SMF Music Files or other music files compatible with Roland digital pianos (p. 183). Also, if you want to save your work on floppy disk, you need to format the floppy disk first (p. 109).

**Indication: Error.13**

Meaning: The floppy disk was removed from the disk drive while reading or writing was in progress. Insert the floppy disk and repeat the procedure.

**Indication: Error.14**

Meaning: This floppy disk is damaged and cannot be used. Insert a different disk and repeat the procedure.

**Indication: Error.15**

Meaning: This song or music style cannot be read. Also, you can only use User Programs that have been saved with the KF-90 (p. 140).

**Indication: Error.16**

Meaning: The KF-90 cannot read the floppy disk quickly enough. Press the Stop [ ■ ] button, then press the Reset [ ◀ ] button and Play [ ▶ ] button to play the song.

**Indication: Error.30**

Meaning: The internal memory capacity of the KF-90 is full. Save the song or music style data on a floppy disk to delete the song data or the User style stored on the KF-90 memory.

**Indication: Error.40**

Meaning: The KF-90 cannot deal with the excessive MIDI data sent from the external MIDI device. Reduce the amount of MIDI data sent to the KF-90.

**Indication: Error.41**

Meaning: A MIDI cable or computer cable has been disconnected. Connect it properly and securely.

**Indication: Error.42**

Meaning: An excessive amount of performance data has been sent to KF-90 in one time and therefore could not be recorded. Change the tempo more slowly to record the performance again.

**Indication: Error.43**

Meaning: The Computer Switch is set to a wrong position or the computer is set wrongly. Switch off the KF-90 then set the Computer Switch to the correct position and set the computer correctly. After that, switch on the KF-90 again.

**Indication: Error.51**

Meaning: There is something wrong with the system. Repeat the procedure from the beginning.

*\* If it is not solved after you have tried several times, contact the Roland service center.*

# Tone List

## [Piano] Group

---

Grand Piano1  
Ballad Piano  
Bright Piano  
Piano Choir  
PianoStrings  
Air Grand  
Rock Piano  
Honky-tonk  
Honky-tonk 2  
Harpsi.Singl  
Harpsi.Doubl  
Harpichord  
Grand Piano2  
Bell Piano  
Piano Oohs  
Synth Harpsi  
Harpsi.o  
Coupled Hps.  
UprightPiano  
MIDI Piano1  
MIDI Piano2  
Piano 1  
Piano 2  
Piano 3

## [E.Piano] Group

---

Stage Rhodes  
Dyno Rhodes  
Suitcase  
E.Piano 1  
E.Piano 2  
E.Piano 3  
Wurly  
EG+Rhodes 1  
EG+Rhodes 2  
Vibraphone  
Marimba  
Soft Marimba  
Clav.  
Hard Clav.  
Soft Clav.  
Glockenspiel  
Xylophone  
Vibra Bells  
Soft E.Piano  
60's E.Piano  
Hard E.Piano  
Pop Vibe.  
Pop Celesta  
Music Box  
FM+SA EP

St.FM EP  
Hard FM EP  
Balafon  
Santur  
Steel Drums  
Detuned EP 1  
Detuned EP 2  
Hard Rhodes  
SynRingClav.  
Reso Clav.  
Phase Clav.  
Tubular-bell  
Kalimba  
Celesta  
Analog Clav.

## [Organ] Group

---

Rock Organ1  
Rock Organ2  
Jazz Organ 1  
Rotary Org.S  
Rotary Org.F  
L-Organ  
Full Organ 1  
Full Organ 2  
Full Organ 3  
Jazz Organ2  
Jazz Organ3  
Jazz Organ4  
Nason flt 8'  
Diapason 8'  
Organ Flute  
Accordion  
Hard Accord  
Harmonica  
Lower Organ1  
Lower Organ2  
Full Organ 4  
Pop Organ  
VS Organ  
CheeseOrgan  
Organ Bass  
Pipe Org. Bs  
Metalic Org.  
Trem.Flute  
Church Organ  
Theater Org.  
Organ 1  
Organ 2  
Digi Church

## [Guitar/Bass] Group

---

EX Ac.Guitar  
Nylon Guitar  
Steel Guitar  
Jazz Guitar  
JC E.Guitar  
DistortionGt  
Gut Guitar  
12str Guitar  
Overdrive Gt  
Fingered Bs.  
Picked Bs.  
Fretless Bs.  
Rock Rhythm  
Rock Rhythm2  
Muted Dis.Gt  
Acoustic Bs.  
A.Bass+Cymb  
Mute PickBs.  
Power Guitar  
Power Gt.2  
Open Hard  
Mandolin  
Hawaiian Gt.  
Shamisen  
Feedback Gt.  
Feedback Gt2  
Dazed Guitar  
Ukulele  
Banjo  
Koto  
Nylon+Steel  
Nylon Gt.o  
Steel Vox  
Jungle Bass  
Modular Bass  
WireStr Bass  
Muted Gt.  
Muted Gt.2  
Mellow Gt.  
Synth Bass 1  
Synth Bass 2  
Mr.Smooth  
5th Dist.  
Gt.Harmonics  
Slap Bass  
ResoSH Bass  
SH101 Bass  
SynthBass101

**[Synth] Group**

JP SuperSaw  
 LM PureLead  
 SquareWave2  
 Holy Voices  
 New Age Pad  
 Sugar Key  
 Natural Lead  
 2600 SubOsc  
 Acid Guitar  
 Org Bells  
 Clear Bells  
 Fantasia  
 LM Square  
 Warm SquPad  
 HollowReleas  
 Soft Crystal  
 Crystal  
 Fantasia 2  
 FM Lead 1  
 FM Lead 2  
 Mg Lead  
 Harpvox  
 CC Solo  
 Brightness  
 Dual Sqr&Saw  
 P5 Saw Lead  
 Rhythmic Saw  
 Waspy Synth  
 JP8 Pulse  
 Cheese Saw  
 Syn.Square  
 JP8 Square  
 Warm Pad  
 Digi Bells  
 Nylon Harp  
 Nylon+Rhodes  
 Soft Pad  
 P5 Poly  
 Reso Saw  
 RAVE Vox  
 Fat & Perky  
 Heaven II  
 JP8 Sqr Pad  
 Sweep Pad 2  
 Converge  
 Big Panner  
 Ai-yai-a  
 Echo Pan 2  
 Falling Down  
 Poly King  
 Octave Stack  
 Vox Sweep  
 Rising Osc

**[Strings] Group**

Strings  
 Slow Strings  
 Velo Strings  
 Violin  
 Cello  
 Harp  
 Tremolo Str  
 Suspense Str  
 SlowStrings2  
 EX Orchestra  
 Slow Violin  
 Contrabass  
 Choir Str  
 Harp Strings  
 Bell Strings  
 PizzicatoStr  
 Mellow Pizz.  
 Timpani  
 Strings 2  
 Legato Str  
 Warm Strings  
 Syn.Strings1  
 Syn.Strings2  
 Syn.Slow Str  
 Orchestra  
 OrchestraHit  
 Oct Strings  
 Warm JP Str  
 JP Saw Str  
 OB Strings  
 Euro Hit  
 Philly Hit  
 6th Hit  
 Bass Hit

**[Sax] Group**

EX Alto Sax  
 AltoSax Soft  
 Tenor Sax f  
 Flute  
 Oboe  
 Pan Flute  
 Soprano Sax  
 Blow Sax  
 Sax Section  
 English Horn  
 Clarinet  
 Bs Clarinet  
 Baritone Sax  
 AltoSax + Tp  
 Grow Sax

Bottle Blow  
 BottleBlow2  
 GS Eng.Horn  
 Alto Sax  
 Tenor Sax  
 GS Bari Sax  
 Bassoon  
 Piccolo  
 Recorder  
 GS Pan Flute  
 Shakuhachi  
 Ocarina  
 Blow Pipe

**[Brass] Group**

Power Brass  
 Bright Brass  
 BrassSection  
 EX Trumpet  
 Brass ff  
 SuperF.Horns  
 Trombone  
 Flugel Horn  
 Fr.Horn Solo  
 Trumpet  
 MutedTrumpet  
 Tuba  
 Tp Shake  
 EX Tp&Shake  
 St. Brass ff  
 TromboneSoft  
 Trombone2  
 OrchestraBrs  
 Brass 1  
 Brass 2  
 Soft Brass  
 DeepSynBrass  
 Oct SynBrass  
 Jump Brass  
 Synth Brass1  
 Synth Brass2  
 French Horn  
 GS Tuba

## Tone List

---

### [Voice/GS] Group

---

Jazz Scat	Detuned Or.1	Orchestra	Warm Pad
Dreamy Choir	Detuned Or.2	GS Sl.Str	Polysynth
Humming	Church Org.1	Syn.Strings1	Space Voice
Rich Choir	Church Org.2	Syn.Strings2	Bowed Glass
Doos Voice	Church Org.3	Syn.Strings3	Metal Pad
Choir Oohs	Full Organ 4	Choir Aahs	Halo Pad
Pop Voice	Jazz Organ 1	Choir	Sweep Pad
SynVox	Rock Organ2	Pop Voice	Ice Rain
Thum Voice	Reed Organ	SynVox	Soundtrack
Doot Accent	Accordion Fr	OrchestraHit	Crystal
Dat Accent	Accordion It	GS Trumpet	Syn Mallet
Bop Accent	GS Harmonica	GS Trombone	Atmosphere
Choir	Bandoneon	Trombone 2	Brightness
Choir Aahs	GS Nylon Gt.	GS Tuba	Goblin
	Nylon Guitar	MutedTrumpet	Echo Drops
	Nylon Gt.o	French Horn	Echo Bell
	Ukulele	Fr.Horn 2	Echo Pan
	Steel-str.Gt	Brass 1	Star Theme
	12-str.Gt	Brass 2	Sitar
Piano 1	GS Mandolin	Synth Brass1	Sitar 2
Piano 1w	Jazz Guitar	Synth Brass2	Banjo
Piano 1d	GS Hawaiian	Synth Brass3	GS Shamisen
Piano 2	Clean Gt.	Synth Brass4	Koto
Piano 2w	Chorus Gt.	AnalogBrass1	Taisho Koto
Piano 3	Muted Gt.	AnalogBrass2	Kalimba
Piano 3w	Funk Gt.	GS Sop.Sax	Bagpipe
GS Honkytonk	Funk Gt.2	Alto Sax	Fiddle
Honky-tonk 2	Overdrive Gt	Tenor Sax	Shanai
GS E.Piano1	GS Dist.Gt	GS Bari Sax	Tinkle Bell
GS E.Piano2	Feedback Gt.	GS Oboe	Agogo
60's E.Piano	Gt.Harmonics	GS Eng.Horn	Steel Drums
E.Piano 1v	Gt. Feedback	Bassoon	Woodblock
E.Piano 2v	GS Ac.Bass	Clarinet	Castanets
Detuned EP 1	GS Fing.Bass	Piccolo	Taiko
Detuned EP 2	GS Picked Bs	GS Flute	Concert BD
GS Harpsi.	Fretless Bs.	Recorder	Melo. Tom 1
Coupled Hps.	Slap Bass	GS Pan Flute	Melo. Tom 2
Harpsi.w	Slap Bass 2	Bottle Blow	Synth Drum
Harpsi.o	SynthBass101	Shakuhachi	808 Tom
Soft Clav.	Synth Bass 1	Whistle	Elec Perc.
Celesta	Synth Bass 2	Ocarina	Reverse Cym.
GS Glocken	Synth Bass 3	Square Wave	Gt.FretNoise
GS Music Box	Synth Bass 4	Square	Gt.Cut Noise
GS Vibe	Rubber Bass	Sine Wave	String Slap
Vibe.w	GS Violin	Saw Wave	Breath Noise
GS Marimba	Slow Violin	Saw	Fl.Key Click
Marimba	Viola	Doctor Solo	Seashore
Xylophone	GS Cello	Syn.Calliope	Rain
Tubular-bell	Contrabass	Chiffer Lead	Thunder
Church Bell	GS Trem.Str	Charang	Wind
Carillon	PizzicatoStr	Solo Vox	Stream
GS Santur	GS Harp	5th Saw Wave	Bubble
Organ 1	Timpani	Bass & Lead	Bird
Organ 2	GS Strings	Fantasia	Dog
Pop Organ 1			



Horse-Gallop	Steel-strGt*	Bottle Blow*
Bird 2	Jazz Guitar*	Shakuhachi*
Telephone 1	Clean Gt.*	Whistle*
Telephone 2	Muted Gt.*	Ocarina*
DoorCreaking	Funk Gt.*	Square Wave*
Door	OverdriveGt*	Saw Wave*
Scratch	Dist.Guitar*	Doctor Solo*
Windchime	Gt.Harmo*	SynCalliope*
Helicopter	Acoustic Bs*	ChifferLead*
Car-Engine	Fingered Bs*	Charang*
Car-Stop	Picked Bs.*	Solo Vox*
Car-Pass	Fretless Bs*	5th SawWave*
Car-Crash	Slap Bass 1*	Bass & Lead*
Siren	Slap Bass 2*	Fantasia*
Train	Synth Bass1*	Warm Pad*
Jetplane	Synth Bass2*	Polysynth*
Starship	Rubber Bass*	Space Voice*
Burst Noise	Violin*	Bowed Glass*
Applause	Viola*	Metal Pad*
Laughing	Cello*	Halo Pad*
Screaming	Contrabass*	Sweep Pad*
Punch	Tremolo Str*	Ice Rain*
Heart Beat	Pizzicato*	Soundtrack*
Footsteps	Harp*	Crystal*
Gun Shot	Timpani*	Syn Mallet*
Machine Gun	Strings*	Atmosphere*
Lasergun	SlowStrings*	Brightness*
Explosion	Syn.Str 1*	Goblin*
Piano 1*	Syn.Str 2*	Echo Drops*
Piano 2*	Choir Aahs*	Star Theme*
Piano 3*	Pop Voice*	Sitar*
Honky-tonk*	SynVox*	Banjo*
E.Piano 1*	Orche.Hit*	Shamisen*
E.Piano 2*	Trumpet*	Koto*
Harpichord*	Trombone*	Kalimba*
Clav.*	Tuba*	Bagpipe*
Celesta*	M.Trumpet*	Fiddle*
Glocken*	FrenchHorns*	Shanai*
Music Box*	Brass 1*	Tinkle Bell*
Vibraphone*	SynthBrass1*	Agogo*
Marimba*	SynthBrass2*	Steel Drums*
Xylophone*	A.Brass 1*	Woodblock*
Tubularbell*	Soprano Sax*	Taiko*
Santur*	Alto Sax*	Melo.Tom 1*
Organ 1*	Tenor Sax*	Synth Drum*
Organ 2*	BaritoneSax*	ReverseCym.*
Pop Organ 1*	Oboe*	Fret Noise*
Rock Organ2*	EnglishHorn*	BreathNoise*
ChurchOrg.1*	Bassoon*	Seashore*
Reed Organ*	Clarinet*	Bird*
AccordionFr*	Piccolo*	Telephone 1*
Harmonica*	Flute*	Helicopter*
Bandoneon*	Recorder*	Applause*
Nylon-strGt*	Pan Flute*	Gun Shot*

\* Tone with a "\*" symbol appended to their name may not play back satisfactorily on other GS sound generating devices.

# Drum/SFX Set List

\* -----: No sound.

\* [EXC]: will not sound simultaneously with other percussion instruments of the same number.

	POP	ROCK	JAZZ BRUSH	VOX DRUM
21	R&B Snare	R&B Snare	R&B Snare	R&B Snare
22	Rock Snare	Pop Snare m	Pop Snare m	Rock Snare
23	Rock Snare	Pop Snare m	Pop Snare m	Rock Snare
24	Pop Snare m	Pop Snare m	Pop Snare m	Pop Snare m
25	Pop Snare Ghost	Pop Snare Ghost	Pop Snare Ghost	Pop Snare Ghost
26	Pop Snare m	Pop Snare m	Pop Snare m	Pop Snare m
27	Finger Snap	Finger Snap	Finger Snap	Finger Snap
28	707 Claps	707 Claps	707 Claps	707 Claps
29	Hand Clap [EXC7]	Hand Clap [EXC7]	Hand Clap [EXC7]	Hand Clap [EXC7]
30	Hand Clap2 [EXC7]	Hand Clap2 [EXC7]	Hand Clap2 [EXC7]	Hand Clap2 [EXC7]
31	Hand Clap	Hand Clap	Hand Clap	Hand Clap
32	Pop Pedal HH [EXC1]	Pop Pedal HH [EXC1]	Pop Pedal HH [EXC1]	Pop Pedal HH
33	Gospel Hand Clap	Gospel Hand Clap	Gospel Hand Clap	Gospel Hand Clap
34	Snare Roll	Snare Roll	Snare Roll	Vox Dut
35	Pop Kick	Rock Kick	Pop Kick	Vox Dom
C2 36	Pop Kick	Rock Kick	Pop Kick	Vox Tuush
37	Pop Side Stick	Rock Side Stick	Jazz Snare Swing	Vox Hehho
38	Pop Sanre s	Rock Sanre s	Jazz Sanre	Vox Doyear
39	Pop Snare Ghost	Rock Snare Ghost	Pop Snare Swing	Vox Thu!
40	Pop Snare s	Rock Snare s	Jazz Sanre	Vox That
41	Pop Low Tom f	Rock Low Tom f	Jazz Low Tom f	Vox Aahhh
42	Pop CHH 1 [EXC1]	Rock CHH 1 [EXC1]	Pop CHH 1 [EXC1]	Vox Tu
43	Pop Low Tom	Rock Low Tom	Jazz Low Tom	Vox Dooh
44	Pop CHH 2 [EXC1]	Rock CHH 2 [EXC1]	Pop CHH 2 [EXC1]	Vox Ptu
45	Pop Mid Tom f	Rock Mid Tom f	Jazz Mid Tom f	Vox Down
46	Pop OHH [EXC1]	Rock OHH [EXC1]	Pop OHH [EXC1]	Vox Pa
47	Pop Mid Tom	Rock Mid Tom	Jazz Mid Tom	Vox Bom
C3 48	Pop High Tom f	Rock High Tom f	Jazz High Tom f	Vox Toear
49	Pop Crash Cymbal 1	Rock Crash Cymbal	Jazz Crash Cymbal 1	Vox Aahhu
50	Pop High Tom	Rock High Tom	Jazz High Tom	Vox Toya
51	Pop Ride Cymbal 1	Rock Ride Cymbal 1	Jazz Ride Cymbal 1	Vox Thu
52	Pop Chinees Cymbal	Pop Chinees Cymbal	Jazz Chinees Cymbal	Vox Cheey
53	Pop Ride Bell	Pop Ride Bell	Jazz Ride Cymbal 2	Vox Cymm
54	Tambourine 2	Tambourine 2	Tambourine 2	Vox Tub
55	Splash Cymbal	Splash Cymbal	Splash Cymbal	Vox Pruru
56	Cha Cha Cowbell	Cha Cha Cowbell	Cha Cha Cowbell	Vox Tut
57	Pop Crash Cymbal 2	Chinees Cymbal	Jazz Crash Cymbal 2	Vox Tyun
58	Vibra-slap 2	Vibra-slap 2	Vibra-slap 2	Vox Tdum
59	Pop Ride Cymbal 2	Pop Ride Cymbal 3	Pop Ride Cymbal 2	Vox Afahhhh
C4 60	High Bongo 2	High Bongo 2	High Bongo 2	High Bongo 2
61	Low Bongo 2	Low Bongo 2	Low Bongo 2	Low Bongo 2
62	Mute Conga	Mute Conga	Mute Conga	Mute Conga
63	High Conga 2	High Conga 2	High Conga 2	High Conga 2
64	Low Conga 2	Low Conga 2	Low Conga 2	Low Conga 2
65	High Timbale 2	High Timbale 2	High Timbale 2	High Timbale 2
66	Low Timbale 2	Low Timbale 2	Low Timbale 2	Low Timbale 2
67	High Agogo	High Agogo	High Agogo	High Agogo
68	Low Agogo	Low Agogo	Low Agogo	Low Agogo
69	Shaker 3	Shaker 3	Shaker 3	Shaker 3
70	Shaker 4	Shaker 4	Shaker 4	Shaker 4
71	Short Hi Whistle [EXC2]	Short Hi Whistle [EXC2]	Short Hi Whistle [EXC2]	Short Hi Whistle [EXC2]
C5 72	Long Low Whistle [EXC2]	Long Low Whistle [EXC2]	Long Low Whistle [EXC2]	Long Low Whistle [EXC2]
73	Short Guiro [EXC3]	Short Guiro [EXC3]	Short Guiro [EXC3]	Short Guiro [EXC3]
74	Long Guiro [EXC3]	Long Guiro [EXC3]	Long Guiro [EXC3]	Long Guiro [EXC3]
75	Claves	Claves	Claves	Claves
76	High Wood Block	High Wood Block	High Wood Block	High Wood Block
77	Low Wood Block	Low Wood Block	Low Wood Block	Low Wood Block
78	Mute Cuica [EXC4]	Mute Cuica [EXC4]	Mute Cuica [EXC4]	Mute Cuica [EXC4]
79	Open Cuica [EXC4]	Open Cuica [EXC4]	Open Cuica [EXC4]	Open Cuica [EXC4]
80	Mute Triangle [EXC5]	Mute Triangle [EXC5]	Mute Triangle [EXC5]	Mute Triangle [EXC5]
81	Open Triangle [EXC5]	Open Triangle [EXC5]	Open Triangle [EXC5]	Open Triangle [EXC5]
82	Shaker	Shaker	Shaker	Shaker
83	Jingle Bell	Jingle Bell	Jingle Bell	Jingle Bell
C6 84	Bell Tree	Bell Tree	Bell Tree	Bell Tree
85	Castanets	Castanets	Castanets	Castanets
86	Mute Surdo [EXC6]	Mute Surdo [EXC6]	Mute Surdo [EXC6]	Mute Surdo [EXC6]
87	Open Surdo [EXC6]	Open Surdo [EXC6]	Open Surdo [EXC6]	Open Surdo [EXC6]
88	Cana	Cana	Cana	Cana

	POP	ROCK	JAZZ BRUSH	VOX DRUM
89	90 Falamenco Hi-Timbale	Falamenco Hi-Timbale	Falamenco Hi-Timbale	Falamenco Hi-Timbale
	Falamenco Lo-Timbale	Falamenco Lo-Timbale	Falamenco Lo-Timbale	Falamenco Lo-Timbale
91	Falamenco Tmbl Flam	Falamenco Tmbl Flam	Falamenco Tmbl Flam	Falamenco Tmbl Flam
	92 Shekere 1	Shekere 1	Shekere 1	Shekere 1
93	Shekere 2	Shekere 2	Shekere 2	Shekere 2
	94 Low Bongo Mute	Low Bongo Mute	Low Bongo Mute	Low Bongo Mute
95	High Bongo Mute	High Bongo Mute	High Bongo Mute	High Bongo Mute
C7 96	-----	-----	-----	-----
	97 -----	-----	-----	-----
98	-----	-----	-----	-----
	99 -----	-----	-----	-----
100	Falamenco HC	Falamenco HC	Falamenco HC	Falamenco HC
101	Falamenco HC	Falamenco HC	Falamenco HC	Falamenco HC
	102 Bongo Cowbell	Bongo Cowbell	Bongo Cowbell	Bongo Cowbell
103	-----	-----	-----	-----
	104 Bongo Cowbell	Bongo Cowbell	Bongo Cowbell	Bongo Cowbell
105	-----	-----	-----	-----

# Drum/SFX Set List

	STANDARD*	ROOM*	POWER	ELECTRONIC
21	----	----	----	----
22	----	----	----	----
23	----	----	----	----
24	Bar Chime	Bar Chime	Bar Chime	Bar Chime
25	Snare Roll	Snare Roll	Snare Roll	Snare Roll
26	Finger Snap	Finger Snap	Finger Snap	Finger Snap
27	High Q	High Q	High Q	High Q
28	Slap	Slap	Slap	Slap
29	Scratch Push [EXC7]	Scratch Push [EXC7]	Scratch Push [EXC7]	Scratch Push [EXC7]
30	Scratch Pull [EXC7]	Scratch Pull [EXC7]	Scratch Pull [EXC7]	Scratch Pull [EXC7]
31	Sticks	Sticks	Sticks	Sticks
32	Square Click	Square Click	Square Click	Square Click
33	Metronome Click	Metronome Click	Metronome Click	Metronome Click
34	Metronome Bell	Metronome Bell	Metronome Bell	Metronome Bell
35	Std Kick 2'	Kick1	Std Kick 2'	Std Kick 2'
C2 36	Kick 1	Room Kick	MONDO Kick	Elec BD
37	Side Stick	Side Stick	Side Stick	Side Stick
38	Std Snr 1	Room Snr 1	Gated SD	Elec SD
39	Hand Clap	Hand Clap	Hand Clap	Hand Clap
40	Std Snr 2	Std Snr 1	Snare Drum 2	Gated SD
41	Low Tom 2	Room Low Tom 2'	Room Low Tom 2	Elec Low Tom 2
42	Closed Hi-hat 1' [EXC1]	Closed Hi-hat 1' [EXC1]	Closed Hi-hat 1 [EXC1]	Closed Hi-hat 1 [EXC1]
43	Low Tom 1	Room Low Tom 1'	Room Low Tom 1	Elec Low Tom 1
44	Pedal Hi-hat 1' [EXC1]	Pedal Hi-hat 1' [EXC1]	Pedal Hi-hat 1 [EXC1]	Pedal Hi-hat 1 [EXC1]
45	Mid Tom 2	Room Mid Tom 2'	Room Mid Tom 2	Elec Mid Tom 2
46	Open Hi-hat 1' [EXC1]	Open Hi-hat 1' [EXC1]	Open Hi-hat 1 [EXC1]	Open Hi-hat 1 [EXC1]
47	Mid Tom 1	Room Mid Tom 1'	Room Mid Tom 1	Elec Mid Tom 1
C3 48	High Tom 2	Room Hi Tom 2'	Room Hi Tom 2	Elec Hi Tom 2
49	Crash Cymbal 1	Crash Cymbal 1	Crash Cymbal 1	Crash Cymbal 1
50	High Tom 1	Room Hi Tom 1'	Room Hi Tom 1	Elec Hi Tom 1
51	Ride Cymbal 1	Ride Cymbal 1	Ride Cymbal 1	Ride Cymbal 1
52	Chinese Cymbal	Chinese Cymbal	Chinese Cymbal	Reverse Cymbal
53	Ride Bell	Ride Bell	Ride Bell	Ride Bell
54	Tambourine	Tambourine	Tambourine	Tambourine
55	Splash Cymbal	Splash Cymbal	Splash Cymbal	Splash Cymbal
56	Cowbell	Cowbell	Cowbell	Cowbell
57	Crash Cymbal 2	Crash Cymbal 2	Crash Cymbal 2	Crash Cymbal 2
58	Vibra-slap	Vibra-slap	Vibra-slap	Vibra-slap
59	Ride Cymbal 2	Ride Cymbal 2	Ride Cymbal 2	Ride Cymbal 2
C4 60	High Bongo	High Bongo	High Bongo	High Bongo
61	Low Bongo	Low Bongo	Low Bongo	Low Bongo
62	Mute High Conga	Mute High Conga	Mute High Conga	Mute High Conga
63	Open High Conga	Open High Conga	Open High Conga	Open High Conga
64	Low Conga	Low Conga	Low Conga	Low Conga
65	High Timbale	High Timbale	High Timbale	High Timbale
66	Low Timbale	Low Timbale	Low Timbale	Low Timbale
67	High Agogo	High Agogo	High Agogo	High Agogo
68	Low Agogo	Low Agogo	Low Agogo	Low Agogo
69	Cabasa	Cabasa	Cabasa	Cabasa
70	Maracas	Maracas	Maracas	Maracas
71	Short Hi Whistle [EXC2]	Short Hi Whistle [EXC2]	Short Hi Whistle [EXC2]	Short Hi Whistle [EXC2]
C5 72	Long Low Whistle [EXC2]	Long Low Whistle [EXC2]	Long Low Whistle [EXC2]	Long Low Whistle [EXC2]
73	Short Guiro [EXC3]	Short Guiro [EXC3]	Short Guiro [EXC3]	Short Guiro [EXC3]
74	Long Guiro [EXC3]	Long Guiro [EXC3]	Long Guiro [EXC3]	Long Guiro [EXC3]
75	Claves	Claves	Claves	Claves
76	High Wood Block	High Wood Block	High Wood Block	High Wood Block
77	Low Wood Block	Low Wood Block	Low Wood Block	Low Wood Block
78	Mute Cuica [EXC4]	Mute Cuica [EXC4]	Mute Cuica [EXC4]	Mute Cuica [EXC4]
79	Open Cuica [EXC4]	Open Cuica [EXC4]	Open Cuica [EXC4]	Open Cuica [EXC4]
80	Mute Triangle [EXC5]	Mute Triangle [EXC5]	Mute Triangle [EXC5]	Mute Triangle [EXC5]
81	Open Triangle [EXC5]	Open Triangle [EXC5]	Open Triangle [EXC5]	Open Triangle [EXC5]
82	Shaker	Shaker	Shaker	Shaker
83	Jingle Bell	Jingle Bell	Jingle Bell	Jingle Bell
C6 84	Bell Tree	Bell Tree	Bell Tree	Bell Tree
85	Castanets	Castanets	Castanets	Castanets
86	Mute Surdo [EXC6]	Mute Surdo [EXC6]	Mute Surdo [EXC6]	Mute Surdo [EXC6]
87	Open Surdo [EXC6]	Open Surdo [EXC6]	Open Surdo [EXC6]	Open Surdo [EXC6]
88	----	----	----	----

	TR-808	DANCE	JAZZ GS STANDARD	BRUSH
21	----	----	----	----
22	----	----	----	----
23	----	----	----	----
24	Bar Chime	Bar Chime	Bar Chime	Bar Chime
25	Snare Roll	Snare Roll	Snare Roll	Snare Roll
26	Finger Snap	Finger Snap	Finger Snap	Finger Snap
27	High Q	High Q	High Q	High Q
28	Slap	Slap	Slap	Slap
29	Scratch Push [EXC7]	Scratch Push [EXC7]	Scratch Push [EXC7]	Scratch Push [EXC7]
30	Scratch Pull [EXC7]	Scratch Pull [EXC7]	Scratch Pull [EXC7]	Scratch Pull [EXC7]
31	Sticks	Dance Snr 1	Sticks	Sticks
32	Square Click	Square Click	Square Click	Square Click
33	Metronome Click	Metronome Click	Metronome Click	Metronome Click
34	Metronome Bell	Metronome Bell	Metronome Bell	Metronome Bell
35	Std Kick 2	Kick 1	Std Kick 2	Kick 2
C2 36	808 Bass Drum 1	808 Bass Drum 2	Std Kick 1	Kick 1
37	808 Rim Shot	808 Rim Shot	Side Stick	Side Stick
38	808 Snare Drum	TR-909 Snr	Snare Drum 1	Brush Tap
39	Hand Clap	Hand Clap	Hand Clap	Brush Slap
40	Snare Drum 2	Dance Snr 2	Snare Drum 2	Brush Swirl
41	808 Low Tom 2	808 Low Tom 2	Low Tom 2	Brush Low Tom 2
42	808 CHH [EXC1]	808 CHH [EXC1]	Closed Hi-hat 1 [EXC1]	Closed Hi-hat 2 [EXC1]
43	808 Low Tom 1	808 Low Tom 1	Low Tom 1	Brush Low Tom 1
44	808 CHH [EXC1]	808 CHH [EXC1]	Pedal Hi-hat 1 [EXC1]	Pedal Hi-hat 2 [EXC1]
45	808 Mid Tom 2	808 Mid Tom 2	Mid Tom 2	Brush Mid Tom 2
46	808 OHH [EXC1]	808 OHH [EXC1]	Open Hi-hat 1 [EXC1]	Open Hi-hat 2 [EXC1]
47	808 Mid Tom 1	808 Mid Tom 1	Mid Tom 1	Brush Mid Tom 1
C3 48	808 Hi Tom 2	808 Hi Tom 2	High Tom 2	Brush Hi Tom 2
49	808 Cymbal	808 Cymbal	Crash Cymbal 1	Crash Cymbal 1
50	808 Hi Tom 1	808 Hi Tom 1	High Tom 1	Brush Hi Tom 1
51	Ride Cymbal 1	Ride Cymbal 1	Ride Cymbal 1	Ride Cymbal 1
52	Chinese Cymbal	Chinese Cymbal	Chinese Cymbal	Chinese Cymbal
53	Ride Bell	Ride Bell	Ride Bell	Ride Bell
54	Tambourine	Tambourine	Tambourine	Tambourine
55	Splash Cymbal	Splash Cymbal	Splash Cymbal	Splash Cymbal
56	808 Cowbell	808 Cowbell	Cowbell	Cowbell
57	Crash Cymbal 2	Crash Cymbal 2	Crash Cymbal 2	Crash Cymbal 2
58	Vibra-slap	Vibra-slap	Vibra-slap	Vibra-slap
59	Ride Cymbal 2	Ride Cymbal 2	Ride Cymbal 2	Ride Cymbal 2
C4 60	High Bongo	High Bongo	High Bongo	High Bongo
61	Low Bongo	Low Bongo	Low Bongo	Low Bongo
62	808 High Conga	808 High Conga	Mute High Conga	Mute High Conga
63	808 Mid Conga	808 Mid Conga	Open High Conga	Open High Conga
64	808 Low Conga	808 Low Conga	Low Conga	Low Conga
65	High Timbale	High Timbale	High Timbale	High Timbale
66	Low Timbale	Low Timbale	Low Timbale	Low Timbale
67	High Agogo	High Agogo	High Agogo	High Agogo
68	Low Agogo	Low Agogo	Low Agogo	Low Agogo
69	Cabasa	Cabasa	Cabasa	Cabasa
70	808 Maracas	808 Maracas	Maracas	Maracas
71	Short Hi Whistle [EXC2]	Short Hi Whistle [EXC2]	Short Hi Whistle [EXC2]	Short Hi Whistle [EXC2]
C5 72	Long Low Whistle [EXC2]	Long Low Whistle [EXC2]	Long Low Whistle [EXC2]	Long Low Whistle [EXC2]
73	Short Guiro [EXC3]	Short Guiro [EXC3]	Short Guiro [EXC3]	Short Guiro [EXC3]
74	Long Guiro [EXC3]	Long Guiro [EXC3]	Long Guiro [EXC3]	Long Guiro [EXC3]
75	808 Claves	808 Claves	Claves	Claves
76	High Wood Block	High Wood Block	High Wood Block	High Wood Block
77	Low Wood Block	Low Wood Block	Low Wood Block	Low Wood Block
78	Mute Cuica [EXC4]	Mute Cuica [EXC4]	Mute Cuica [EXC4]	Mute Cuica [EXC4]
79	Open Cuica [EXC4]	Open Cuica [EXC4]	Open Cuica [EXC4]	Open Cuica [EXC4]
80	Mute Triangle [EXC5]	Mute Triangle [EXC5]	Mute Triangle [EXC5]	Mute Triangle [EXC5]
81	Open Triangle [EXC5]	Open Triangle [EXC5]	Open Triangle [EXC5]	Open Triangle [EXC5]
82	Shaker	Shaker	Shaker	Shaker
83	Jingle Bell	Jingle Bell	Jingle Bell	Jingle Bell
C6 84	Bell Tree	Bell Tree	Bell Tree	Bell Tree
85	Castanets	Castanets	Castanets	Castanets
86	Mute Surdo [EXC6]	Mute Surdo [EXC6]	Mute Surdo [EXC6]	Mute Surdo [EXC6]
87	Open Surdo [EXC6]	Open Surdo [EXC6]	Open Surdo [EXC6]	Open Surdo [EXC6]
88	----	----	----	----

# Drum/SFX Set List

## SFX

	ORCHESTRA	GS ROOM	GS BRUSH	SOUND EFFECTS
21	----	----	----	----
22	----	----	----	----
23	----	----	----	----
24	Bar Chime	Bar Chime	Bar Chime	----
25	Snare Roll	Snare Roll	Snare Roll	----
26	Finger Snap	Finger Snap	Finger Snap	----
27	Close Hi-hat [EXC1]	High Q	High Q	----
28	Pedal Hi-hat [EXC1]	Slap	Slap	----
29	Open Hi-hat [EXC1]	Scratch Push [EXC7]	Scratch Push [EXC7]	----
30	Ride Cymbal	Scratch Pull [EXC7]	Scratch Pull [EXC7]	----
31	Sticks	Sticks	Sticks	----
32	Square Click	Square Click	Square Click	----
33	Metronome Click	Metronome Click	Metronome Click	----
34	Metronome Bell	Metronome Bell	Metronome Bell	----
35	Concert BD 2	Std Kick 2	Std Kick 2	----
C2 36	Concert BD 1	Std Kick 1	Std Kick 1	----
37	Side Stick	Side Stick	Side Stick	----
38	Concert SD	Snare Drum 1	Brush Tap	----
39	Castanets	Hand Clap	Brush Slap	High Q
40	Concert SD	Snare Drum 2	Brush Swirl	Slap
41	Timpani F	Room Low Tom 2	Low Tom 2	Scratch Push [EXC7]
42	Timpani F#	Closed Hi-hat 1 [EXC1]	Closed Hi-hat 1 [EXC1]	Scratch Pull [EXC7]
43	Timpani G	Room Low Tom 1	Low Tom 1	Sticks
44	Timpani G#	Pedal Hi-hat 1 [EXC1]	Pedal Hi-hat 1 [EXC1]	Square Click
45	Timpani A	Room Mid Tom 2	Mid Tom 2	Metronome Click
46	Timpani A#	Open Hi-hat 1 [EXC1]	Open Hi-hat 1 [EXC1]	Metronome Bell
47	Timpani B	Room Mid Tom 1	Mid Tom 1	Guitar sliding Finger
C3 48	Timpani c	Room Hi Tom 2	High Tom 2	Guitar cutting noise (up)
49	Timpani c#	Crash Cymbal 1	Crash Cymbal 1	Guitar cutting noise (down)
50	Timpani d	Room Hi Tom 1	High Tom 1	String slap of double bass
51	Timpani d#	Ride Cymbal 1	Ride Cymbal 1	Fl.Key Click
52	Timpani e	Chinese Cymbal	Chinese Cymbal	Laughing
53	Timpani f	Ride Bell	Ride Bell	Screaming
54	Tambourine	Tambourine	Tambourine	Punch
55	Splash Cymbal	Splash Cymbal	Splash Cymbal	Heart Beat
56	Cowbell	Cowbell	Cowbell	Footsteps1
57	Concert Cymbal 2	Crash Cymbal 2	Crash Cymbal 2	Footsteps2
58	Vibra-slap	Vibra-slap	Vibra-slap	Applause
59	Concert Cymbal 1	Ride Cymbal 2	Ride Cymbal 2	Door Creaking
C4 60	High Bongo	High Bongo	High Bongo	Door
61	Low Bongo	Low Bongo	Low Bongo	Scratch
62	Mute High Conga	Mute High Conga	Mute High Conga	Wind Chimes
63	Open High Conga	Open High Conga	Open High Conga	Car-Engine
64	Low Conga	Low Conga	Low Conga	Car-Stop
65	High Timbale	High Timbale	High Timbale	Car-Pass
66	Low Timbale	Low Timbale	Low Timbale	Car-Crash
67	High Agogo	High Agogo	High Agogo	Siren
68	Low Agogo	Low Agogo	Low Agogo	Train
69	Cabasa	Cabasa	Cabasa	Jetplane
70	Maracas	Maracas	Maracas	Helicopter
71	Short Hi Whistle [EXC2]	Short Hi Whistle [EXC2]	Short Hi Whistle [EXC2]	Starship
C5 72	Long Low Whistle [EXC2]	Long Low Whistle [EXC2]	Long Low Whistle [EXC2]	Gun Shot
73	Short Guiro [EXC3]	Short Guiro [EXC3]	Short Guiro [EXC3]	Machine Gun
74	Long Guiro [EXC3]	Long Guiro [EXC3]	Long Guiro [EXC3]	Lasergun
75	Claves	Claves	Claves	Explosion
76	High Wood Block	High Wood Block	High Wood Block	Dog
77	Low Wood Block	Low Wood Block	Low Wood Block	Horse-Gallop
78	Mute Cuica [EXC4]	Mute Cuica [EXC4]	Mute Cuica [EXC4]	Birds
79	Open Cuica [EXC4]	Open Cuica [EXC4]	Open Cuica [EXC4]	Rain
80	Mute Triangle [EXC5]	Mute Triangle [EXC5]	Mute Triangle [EXC5]	Thunder
81	Open Triangle [EXC5]	Open Triangle [EXC5]	Open Triangle [EXC5]	Wind
82	Shaker	Shaker	Shaker	Seashore
83	Jingle Bell	Jingle Bell	Jingle Bell	Stream
C6 84	Bell Tree	Bell Tree	Bell Tree	Bubble
85	Castanets	Castanets	Castanets	Cat
86	Mute Surdo [EXC6]	Mute Surdo [EXC6]	Mute Surdo [EXC6]	----
87	Open Surdo [EXC6]	Open Surdo [EXC6]	Open Surdo [EXC6]	----
88	Applause	----	----	----

# Music Style List

## [Pop]

---

Pop Jazz  
Michael'sPop  
Groovin  
70's 1  
70's 2  
Latin Pop  
  
House Pop  
Euro Dance  
Fusion  
Medium Pop  
Funk Pop  
Contemporary  
  
8Beat Pop 1  
8Beat Pop 2  
16Beat Pop 1  
Cool Al  
Light Pop  
West Coast  
  
Surffun  
50's Pop 1  
50's Pop 2  
Beach Sound  
Mersey Beat  
Acoustic Pop  
  
MorningLight  
Swing Pop  
Light Fusion  
Power 8Beat

## [Rock]

---

Light Rock  
Fast Rock  
Power Pop  
JB Soul  
Lets Twist  
Cntry Rockin  
  
Easy Rock  
Shuffle Rock  
80's Rock  
BigBand Pop  
60's R&B  
50's R&B  
  
Rock 1  
Rock 2  
16Beat Rock  
Rock n Roll  
AcousticRck1  
AcousticRck2

## [Ballad]

---

Soulful Sax  
Swing Ballad  
Pop Ballad  
8BeatBallad1  
8BeatBallad2  
8BeatBallad3  
  
MediumBallad  
70's Ballad  
70's 8beat  
12/8 Ballad  
6/8 SlowRock  
6/8 Ballad  
  
Torch Song  
Dreamin'  
Slow Dance  
Crystal

## [Acoustic]

---

Piano Jazz  
Piano Night  
Piano Pop  
Gtr.Fast Pop  
GuitarBallad  
Cntry Pickin  
  
PianoRagtime  
Piano Slow  
Piano Latin  
Camp Fire  
Guitar Bossa  
Guitar Waltz  
  
PianoShuffle  
Piano Ballad  
Piano Waltz  
Pf Concerto  
PianoBoogie

## [Jazz]

---

Scat Swing  
Slow Swing  
On The Town  
Jazz Waltz  
The Blues  
Big Band  
  
A Cappella  
Organ Swing  
Jazz Band  
Big Serenade  
Fast Waltz  
Big Band 2

## Music Style List

### [Latin]

Mambo  
Latin  
Plena  
Bossa Nova 1  
Bossa Nova 2  
Bossa Nova 3  
  
Merengue  
Bomba  
Salsa  
Fast Bossa  
Slow Beguine  
Slow Bossa  
  
Rhumba  
Samba  
Chacha

### [World]

Mariachi  
Island  
German Rock  
Gospel Shout  
ClassicCntry  
Country Song  
  
Ireland  
Scotland 6/8  
Paris Waltz  
Tejano  
Gospel Pop  
Hawaiian  
  
Scotland  
C&W Ballad  
Western  
Gospel Piano  
Bluegrass  
Rock'n Cntry  
  
Country Folk  
Country Rock  
CountryWaltz  
Festival

### [Traditional]

Foxtrot 2  
Dixieland  
Charleston  
Slow Waltz  
Slow Waltz 2  
Musette  
  
Parade  
Tango  
Last Dance  
Vienna Waltz  
ClasicPolka  
Polka  
  
March  
Foxtrot

### Data Disk Style

01 Ocean Side  
02 16Beat Pop  
03 70's Disco  
04 Pop'n Roll  
05 16BeatBallad  
06 60's Ballad  
07 Swayin'  
08 Contemporary \*  
09 Club Piano  
10 G.Pop  
11 Twist  
12 Shuffle  
13 PianoBoogie2  
14 CountryRoads  
15 CtrySerenade  
16 CountryPiano  
17 Easy Country  
18 Hoedown  
19 Cajun  
20 CountryBlues  
21 BigBandSwing  
22 BigBndBallad  
23 Slow Swing \*  
24 Blues  
25 Combo  
26 Mambo \*  
27 Merengue \*  
28 Calypso  
29 NewBossaNova  
30 Broadway  
31 Jazz Waltz \*  
32 March \*  
33 Habanera  
34 Sevilla  
35 Enka 1  
36 Enka 2

\* A Music Style indicated by "\*" has the same name as a built-in Music Style, but its contents are different.



# Rhythm Pattern List

<b>Prythm Pattern</b>	<b>(Measure)</b>
8 Beat 1	(1)
8 Beat 2	(1)
8 Beat 3	(2)
8 Beat 4	(1)
16Beat 1	(1)
16Beat 2	(2)
Rock 1	(2)
Rock 2	(2)
House 1	(2)
House 2	(1)
Shuffle1	(1)
Shuffle2	(1)
Brush	(2)
Swing 1	(1)
Swing 2	(4)
Waltz	(2)
March 1	(1)
March 2	(2)
BossaNova	(2)
Samba 1	(1)
Samba 2	(1)
Rhumba	(2)
Mambo	(2)
Tango	(2)
Beguine	(1)
Simple4/4	(1)
Simple3/4	(1)
Simple6/8	(2)
CountIn 1	(1)
CountIn 2	(1)
C.InSwing	(1)
Fill In1	(1)
Fill In2	(1)
Fill In3	(1)
Ending 1	(1)
Ending 2	(1)
Ending 3	(1)
Stick 4/4	(1)
Stick 3/4	(1)
Stick 6/8	(1)

# Chord List

● symbol : Indicates the constituent note of chords.

★ symbol : Chord shown with an “★” can be played by pressing just the key marked with the “★” (p. 68).

C	C#	D	E $\flat$	E	F
CM7	C#M7	DM7	E $\flat$ M7	EM7	FM7
C7	C#7	D7	E $\flat$ 7	E7	F7
Cm	C#m	Dm	E $\flat$ m	Em	Fm
Cm7	C#m7	Dm7	E $\flat$ m7	Em7	Fm7
Cdim	C#dim	Ddim	E $\flat$ dim	Edim	Fdim
Cm7 (b5)	C#m7 (b5)	Dm7 (b5)	E $\flat$ m7 (b5)	Em7 (b5)	Fm7 (b5)
Caug	C#aug	Daug	E $\flat$ aug	Eaug	Faug
Csus4	C#sus4	Dsus4	E $\flat$ sus4	Esus4	Fsus4
C7sus4	C#7sus4	D7sus4	E $\flat$ 7sus4	E7sus4	F7sus4
C6	C#6	D6	E $\flat$ 6	E6	F6
Cm6	C#m6	Dm6	E $\flat$ m6	Em6	Fm6

F#	G	A $\flat$	A	B $\flat$	B
F#M7	GM7	A $\flat$ M7	AM7	B $\flat$ M7	BM7
F#7	G7	A $\flat$ 7	A7	B $\flat$ 7	B7
F#m	Gm	A $\flat$ m	Am	B $\flat$ m	Bm
F#m7	Gm7	A $\flat$ m7	Am7	B $\flat$ m7	Bm7
F#dim	Gdim	A $\flat$ dim	Adim	B $\flat$ dim	Bdim
F#m7 (b5)	Gm7 (b5)	A $\flat$ m7 (b5)	Am7 (b5)	B $\flat$ m7 (b5)	Bm7 (b5)
F#aug	Gaug	A $\flat$ aug	Aaug	B $\flat$ aug	Baug
F#sus4	Gsus4	A $\flat$ sus4	Asus4	B $\flat$ sus4	Bsus4
F#7sus4	G7sus4	A $\flat$ 7sus4	A7sus4	B $\flat$ 7sus4	B7sus4
F#6	G6	A $\flat$ 6	A6	B $\flat$ 6	B6
F#m6	Gm6	A $\flat$ m6	Am6	B $\flat$ m6	Bm6

# Effects List

Display	Description
<b>Chorus</b>	Makes sounds broader and fatter.
<b>Stereo Chorus</b>	A stereo chorus.
<b>Hexa Chorus</b>	A multilayer chorus.
<b>Tremolo Chorus</b>	A chorus with a tremolo effect.
<b>Space D</b>	A clear chorus.
<b>Rotary</b>	Adds a rotary-speaker effect.
<b>Stereo Delay</b>	Delays the sound with a stereo effect.
<b>Modulation Delay</b>	Adds a wavering effect to the delayed sound.
<b>Triple Tap Delay</b>	A three-way delay.
<b>Quadruple Tap Delay</b>	A four-way delay.
<b>Phaser</b>	Adds undulations to the sound.
<b>Stereo Flanger</b>	Adds metallic reverberations.
<b>Step Flanger</b>	A flanger that varies the pitch in a stepwise fashion.
<b>Enhancer</b>	Adds modulation to the sound.
<b>Overdrive</b>	Applies soft distortion to the sound.
<b>Distortion</b>	Applies hard distortion to the sound.
<b>Auto Wah</b>	Changes the tone in a cyclical manner.
<b>Compressor</b>	Suppresses fluctuations in volume.
<b>Gate Reverb</b>	Cuts off the reverberations before they fade away completely.
<b>2V Pitch Shifter</b>	Adds two pitch-shifted sounds to the original sound (two-voice pitch shifter).
<b>FB Pitch Shifter</b>	The pitch will change in steps (feedback pitch shifter).
<b>Enhancer-&gt;Chorus</b>	Applies both enhancer and chorus effects.
<b>Enhancer-&gt;Flanger</b>	Applies both enhancer and flanger effects.
<b>Enhancer-&gt;Delay</b>	Applies both enhancer and delay effects.
<b>Chorus-&gt;Delay</b>	Applies both chorus and delay effects.
<b>Flanger-&gt;Delay</b>	Applies both flanger and delay effects.
<b>Overdrive-&gt;Chorus</b>	Applies both overdrive and chorus effects.
<b>Overdrive-&gt;Flanger</b>	Applies both overdrive and flanger effects.
<b>Overdrive-&gt;Delay</b>	Applies both overdrive and delay effects.
<b>Distortion-&gt;Chorus</b>	Applies both distortion and chorus effects.
<b>Distortion-&gt;Flanger</b>	Applies both distortion and flanger effects.
<b>Distortion-&gt;Delay</b>	Applies both distortion and delay effects.
<b>Sympathetic Resonance</b>	Applies a resonance effect when the damper pedal is depressed.
<b>Wave Chorus</b>	Produces a chorus with strong undulations.
<b>2 Band Chorus</b>	Applies different chorus effects in the treble and bass bands.
<b>Space Chorus</b>	A chorus with extremely small undulations.
<b>Chorus-&gt;Flanger</b>	Applies both chorus and flanger effects.
<b>Rhodes Multi</b>	The optimal effect for an electric piano.
<b>Clean Guitar Multi 1</b>	Applies an effect that combines compressor, chorus, and delay.
<b>Clean Guitar Multi 2</b>	Applies an effect that combines Auto Wah, Equalizer, chorus, and delay.
<b>Tremolo</b>	Produces cyclical changes in volume.
<b>Auto Pan</b>	Makes the sonic position of the sound move to the left or right.
<b>Chorus/Delay</b>	This effect connect a chorus and a delay in parallel.
<b>Chorus/Flanger</b>	This effect connect a chorus and a flanger in parallel.
<b>Rotary Multi</b>	Applies an effect that combines rotary, Equalizer and Over Drive.
<b>Keyboard Multi</b>	Applies an effect that combines Ring Modulator, Equalizer, Pitch Shifter, Phaser, and Delay.

# Demo Song List

No.	Title	Composer	Copyright
1	First Time Around	Scott Wilkie	© 2000 Scott Wilkie (ASCAP)
2	Jobs For The Boys	John Maul	© 2000 John Maul
3	Howz It Feel?	Scott Wilkie	© 2000 Scott Wilkie (ASCAP)
4	Midnight Blue	Masashi & Kazuko Hirashita	© 2000 Roland Corporation
5	Joyful Sunday	Masashi & Kazuko Hirashita	© 2000 Roland Corporation

\* Use of the song data and music style data supplied with this product for any purpose other than private, personal enjoyment without the permission of the copyright holder is prohibited by law. Additionally, this data must not be copied, nor used in a secondary copyrighted work without the permission of the copyright holder.

\* No data for the music that is played will be output from MIDI OUT.

## Profile

### John Maul

John Maul is a musician, composer and arranger having graduated from the Royal Academy of Music in London. John's work encompasses studio recordings and live performances including work with top UK Jazz artists.

His writing credits include commercial music for BBC radio and television, as well as scoring jazz and classical works.

Having been a product specialist for Roland U.K., John is now actively involved in music software composing/programming for both Roland Japan and various music publishers. Quite recently his "Musical Picture Book," a volume of original piano music encompassing all standards of musical ability, which included the piano and orchestral accompaniment data in SMF format, was published and printed.

### Scott Wilkie

Scott Wilkie is a contemporary jazz recording artist, based in southern California. He has several recordings available on NaradaJazz Records, and he tours frequently with his own band. He also appears worldwide as an artist for Roland. You can find him on-line at [www.scottwilkie.com](http://www.scottwilkie.com).

### Kazuko Hirashita, Masashi Hirashita

Masashi and Kazuko both started studying classical piano when they were in their infancy. Both went on to study composition.

At the same time, they had started their own music careers as keyboardists and composers. Their work covers a wide spectrum of styles and activities, including pop, fusion and jazz music as well as many writing and producing jobs.

# Data Disk Song List

No.	Title	Composer	Copyright
1	Menuet in G Major, BWV. Anh. 114 from "Notebook Of Anna Magdalena Bach"	J. S. Bach	© 1992 Roland Corporation
2	Gymnopedie No. 1	E. Satie	© 1997 Roland Corporation
3	Piano Sonata No. 15 in C Major, 1st Movement	W. A. Mozart	© 1996 Roland Corporation
4	"Fröhlicher Landmann" from "Album Für Die Jugend" Op. 68	R. Schumann	© 1996 Roland Corporation
5	Londonderry Air	Irish Folksong	© 1993 Roland Corporation
6	A Maiden's Prayer	T. Badarzewska	© 1996 Roland Corporation
7	Ave Maria	C. Gounod	© 1993 Roland Corporation
8	The Entertainer	S. Joplin	© 1994 Roland Corporation
9	Air from Ouverture No.3 BWV.1068	J. S. Bach	© 1996 Roland Corporation
10	Etude No. 74 from "Beyer Piano Textbook"	F. Beyer	© 1996 Roland Corporation
11	Etude No. 78 from "Beyer Piano Textbook"	F. Beyer	© 1996 Roland Corporation
12	Etude No. 90 from "Beyer Piano Textbook"	F. Beyer	© 1996 Roland Corporation

\* Use of the song data and music style data supplied with this product for any purpose other than private, personal enjoyment without the permission of the copyright holder is prohibited by law. Additionally, this data must not be copied, nor used in a secondary copyrighted work without the permission of the copyright holder.

# Music Files That the KF-90 Can Use

## What Are Music Files?

Music files contain information describing the details of a musical performance, such as “the C3 key on a keyboard was pressed for this amount of time, using this amount of force.” By inserting the floppy disk into the disk drive on the KF-90, the performance information is sent from the floppy disk to the piano, and played faithfully by the piano. This is different than a CD, since the music file does not contain a recording of the sound itself. This makes it possible to erase certain parts, or to change instruments, tempos and keys freely, allowing you to use it in many different ways.

## Regarding Copyright

Use of the song data supplied with the Data Disk attached to this product for any purpose other than private, personal enjoyment without the permission of the copyright holder is prohibited by law. Additionally, this data must not be copied, nor used in a secondary copyrighted work without the permission of the copyright holder.

## ■ The KF-90 allows you to use the following music files

### ● Floppy disks saved on a Roland MT Series, or Roland Piano Digital HP-G/KR Series instrument

### ● Roland Digital Piano Compatible music files

Roland’s original music file is made specifically for practicing the piano. Some follow an instructional curriculum, allowing for a complete range of lessons, such as “practicing each hand separately” or “listening to only the accompaniment.”

### ● SMF Music files (720KB/1.44MB format)

SMFs (Standard MIDI Files) use a standard format for music file that was formulated so that files containing music file could be widely compatible, regardless of the manufacturer of the listening device. An enormous variety of music is available, whether it be for listening, for practicing musical instruments, for Karaoke, etc.

If you wish to purchase SMF music files, please consult the retailer where you purchased your KF-90.

### SMF with Lyrics

“SMF with Lyrics” refers to SMF (Standard MIDI File) that contains the lyrics. When music files carrying the “SMF with Lyrics” logo are played back on a compatible device (one bearing the same logo), the lyrics will appear in its display.

## ■ About the KF-90 Sound Generator

The KF-90 come equipped with GM 2/GS sound generators.

### General MIDI

The General MIDI is a set of recommendations which seeks to provide a way to go beyond the limitations of proprietary designs, and standardize the MIDI capabilities of sound generating devices. Sound generating devices and music files that meets the General MIDI standard bears the General MIDI logo. Music files bearing the General MIDI logo can be played back using any General MIDI sound generating unit to produce essentially the same musical performance.

### General MIDI 2

The upwardly compatible General MIDI 2 recommendations pick up where the original General MIDI left off, offering enhanced expressive capabilities, and even greater compatibility.

Issues that were not covered by the original General MIDI recommendations, such as how sounds are to be edited, and how effects should be handled, have now been precisely defined. Moreover, the available sounds have been expanded.

General MIDI 2 compliant sound generators are capable of reliably playing back music files that carry either the General MIDI or General MIDI 2 logo.

In some cases, the conventional form of General MIDI, which does not include the new enhancements, is referred to as “General MIDI 1” as a way of distinguishing it from General MIDI 2.

### GS Format

The GS Format is Roland’s set of specifications for standardizing the performance of sound generating devices. In addition to including support for everything defined by the General MIDI, the highly compatible GS Format additionally offers an expanded number of sounds, provides for the editing of sounds, and spells out many details for a wide range of extra features, including effects such as reverb and chorus.

Designed with the future in mind, the GS Format can readily include new sounds and support new hardware features when they arrive.

Since it is upwardly compatible with the General MIDI, Roland’s GS Format is capable of reliably playing back GM Scores equally as well as it performs GS music files (music files that have been created with the GS Format in mind). This product supports both the General MIDI 2 and the GS Format, and can be used to play back music data carrying either of these logos.

# Glossary

## Arrange

This is an abbreviation of “Arrangement.” It refers to changes that have been made in an original tune, by adding a new accompaniment or by changing the instruments used.

## Automatic Accompaniment

The KF-90 automatically plays accompaniment when just a few keys in the lower section of the keyboard are pressed to specify the chord. This is called the “One Touch Arranger” (p. 67).

## Bouncing Ball

The flashing dot that moves in a semicircular pattern across the screen of the KF-90 is called a “Bouncing Ball” (p. 63).

## Chord

Two or more notes sounding at the same time (p. 68).

## Division

The six performance states that make up a Music Style are called “Divisions” (p. 67).

## Drum Set

A Drum Set is a collection of percussive instrument sounds. With drum sets, a different sound can be heard for each key on the keyboard. The special effects sound set is called the “SFX Set” (p. 58).

## Edit

Editing is to change the song you have recorded, such as by erasing part of the song, or copying a measure (p. 124).

## Ending

This is the last part of the accompaniment. When you stop playing the automatic accompaniment, the KF-90 plays an ending appropriate for the style (p. 74).

## Ensemble

A combined performance of two or more instruments is called an “Ensemble.”

## Icon

The on-screen graphics that appear three dimensional work like buttons. These are called “Icons.”

## Intro

This is the introductory portion of an automatic accompaniment performance. The KF-90 plays an intro ideally suited to each style when it starts playing the automatic accompaniment (p. 74).

## Key Touch

This is the sensation of heaviness—the “touch”—of the keys when the keyboard is played.

The KF-90 100 levels of adjustment (p. 144).

## Layer Play

Playing with two different tones on a key simultaneously is called “Layer Play” (p. 53).

## Music Style

Music Styles are performance patterns in various musical genres. A Music Style is played automatically in accord with the specified chord using the KF-90’s One-touch Arranger Function (p. 67).

## Part

On the KF-90, “Part” can have two different meanings. One meaning refers to a performance part (p. 67), such as the right-hand part of a piano song. The other refers to the 16 parts in the 16-track sequencer (p. 118).

## Pickup

A song with a pickup does not start on the first beat (p. 104).

## PU (Pickup)

A song that does not start on the first beat starts with what is called a pickup. When playing a pickup song, the measures will be shown in the display as “PU, 1, 2...”.

## Save

Saving is storing the recorded performance data onto a floppy disk (p. 109).

## Sound Generator

The sound generator of the KF-90 supports GM2/GS, and can play 608 different sounds (p. 183).

## Split Play

The division of the keyboard into upper and lower zones is referred to as “Split,” and different tones can be played in the keys on different sides of the key that acts as the boundary between the upper part and lower part (p. 55).

## Standard Pitch

The pitch of the sound created by playing the middle A on the keyboard is called the “Standard Pitch.” Changing the standard pitch of the KF-90 is called “Master Tune,” and tuning to other musical instrument is called “Tuning” (p. 151).



### **Tone**

Tones are the musical instruments or effect sounds stored in the internal memory of the KF-90. The display shows "TONE."

### **Tuning Curves**

Graphic representations of the changes in pitch of the equally-tempered tuning versus those of actual tunings are called "Tuning Curves" (p. 143).

# MIDI Implementation Chart

DIGITAL PIANO

Date : Mar. 1, 2000

Model KF-90

## MIDI Implementation Chart

Version : 1.00

Function...	Transmitted	Recognized	Remarks
Basic Channel Default Changed	1 1-16	1-16 1-16	
Mode Default Messages Altered	Mode 3 x *****	Mode 3 Mode 3, 4(M=1)	* 2
Note Number : True Voice	15-113 *****	0-127 0-127	
Velocity Note ON Note OFF	O x 8n v=64	O x	
After Touch Key's Ch's	x x	O O	*1 *1
Pitch Bend	O	O	
Control Change	0, 32 O 1 O *1 5 O *1 6, 38 O *1 7 O 10 O *1 11 O *1 64 O 65 O *1 66 O 67 O 84 O *1 91 O 93 O 98, 99 O *1 100, 101 O *1	O *1 O *1 O *1 O *1 O *1 O *1 O *1 O *1 O *1 O *1 O *1 O (Reverb) *1 O (Chorus) *1 O *1 O *1	Bank select Modulation Portamento time Data entry Volume Panpot Expression Hold 1 Portamento Sostenuto Soft Portamento control Effect1 depth Effect3 depth NRPN LSB, MSB RPN LSB, MSB
Prog Change : True #	O 0-127 *****	O 0-127	Program number 1-128
System Exclusive	O	O	
System Common : Song Pos : Song Sel : Tune	x x x	x x x	
System Real Time : Clock : Commands	O O	O O	*3 *3
Aux Message : All sound off : Reset all controllers : Local Control : All Notes OFF : Active Sense : Reset	x x x x O x	O (120, 126, 127) O O O (123-125) O x	
Notes	* 1 O x is selectable by SysEx. * 2 Recognized as M=1 even if M≠1. * 3 O x is selectable.		

Mode 1 : OMNI ON, POLY  
Mode 3 : OMNI OFF, POLY

Mode 2 : OMNI ON, MONO  
Mode 4 : OMNI OFF, MONO

O : Yes  
X : No

# Main Specifications

## <Keyboard>

### Keyboard

88 keys Progressive Hammer Action mechanism

### Touch Sensitivity

100 Levels

### Keyboard Mode

Whole

Split (adjustable Split Point)

Layer

Arranger

Piano Style Arranger

Manual Drum/SFX

## <Sound Source>

Conforms to GM2/GS

### Max. Polyphony

Stereo 64 voices

### Tones

9 groups 608 variations (including 16 drum sets, 1 SFX set)

### Temperament

8 types, selectable tonic

### Stretched Tuning

2 types

### Master Tunings

415.3 Hz to 466.2 Hz (0.1 Hz steps)

### Transpose

Key Transpose (-6 to +5 half-steps)

Playback Transpose (-24 to +24 half-steps)

### Effects

Reverb (8 types, stepless level adjustable)

Chorus (8 types, 127 levels)

Advanced 3D

Sympathetic Resonance, Rotary and 45 other types

Physical Damper Simulation

## <Arranger>

### Music Style

Internal: 8 groups 142 styles x 4 types (Style Orchestrator)

Music Style Disk: 36 styles

### Programmable Music Styles

Style Converter

Style Composer

### Melody Intelligence

24 types

### User Programs

Internal: 36

Disk: Max. 99 sets

## Control

Start/Stop, Intro/Ending (2 types for each styles), Sync.

Start, Fill-In (Variation/Original), Arranger Reset, Count

Down, Melody Intelligence, Break, Leading Bass, Half Fill-

In (Variation/Original)

## <Composer>

### Metronome

Beat: 2/2, 0/4, 2/4, 3/4, 4/4, 5/4, 6/4, 7/4, 3/8, 6/8, 9/8, 12/8

Volume: 10 levels

Pattern: 11 patterns

Sounds: 8 types

### Track

5/16 tracks

### Song

1 song

### Note Storage

Approx. 30,000 notes

### Tempo

Quarter note = 20 to 250

### Resolution

120 ticks per quarter note

### Recording Method

Realtime (Replace, Mix, Auto Punch In,

Manual Punch In, Loop, Tempo)

Step (on Chord Sequence Mode)

Beat Map

### Edit

Copy, Quantize, Delete, Insert, Erase, Transpose, Part

Exchange, Note Edit, PC Edit

### Rhythm Pattern

40 types

### Control

Song Select, Reset, Stop, Play, Rec, Bwd, Fwd, All Song

Play, Track Select, Count In, Playback Balance, Marker

Set, Repeat, Tempo Mute

## Main Specifications

---

### <Disk Drive/Disk Storage>

#### Disk Drive / Disk Storage

3.5 inch micro floppy disk

#### Disk Format

720K bytes (2DD)

1.44M bytes (2HD)

#### Songs

Max. 99 songs

#### Note Storage

Approx. 120,000 notes (2DD)

Approx. 240,000 notes (2HD)

#### Playable Software

Standard MIDI Files (format 0/1)

Roland Original Format (i-format)

#### Save

Standard MIDI Files (format 0)

Roland Original Format (i-format)

### <Others>

#### Rated Power Output

10W x 2

#### Speakers

10cm x 2, 5cm x 2

#### Display

Beat Indicator

Graphic 320 x 240 dot backlit LCD

Language: English/Japanese

#### Lyrics

Yes (Built-in Display, MIDI Out)

#### Control

Volume, Brilliance, Reverb, Balance, Microphone Volume

#### One Touch Play

One Touch Piano, One Touch Arranger

#### Vocal Effects

Echo

Voice Transformer

Harmonist

#### Other Functions

Style Navigator, Tone Navigator, Composer Navigator,

Piano Master, Score, Audition, Panel Lock

### Connectors

Output jacks (L/Mono, R)

Input jacks (L/Mono, R)

Microphone jack

Headphone jack (stereo)

MIDI In connector

MIDI Out connector

Computer connector

Pedal jacks (Damper, Sostenuto, Soft)

### Power supply

AC 117V/ 230V/ 240V

### Power Consumption

38W

### Dimensions (Without the music rest)

Piano (KF-90):

1,321 (W) x 421 (D) x 136 (H) mm

52-1/16 (W) x 16-5/8 (D) x 5-3/8 (H) inches

Stand (FPS-9: Sold separately):

1,258 (W) x 390 (D) x 639 (H) mm

49-9/16 (W) x 15-3/8 (D) x 25-3/16 (H) inches

Total:

1,321 (W) x 421 (D) x 774 (H) mm

52-1/16 (W) x 16-5/8 (D) x 30-1/2 (H) inches

### Weights (Without the music rest)

Piano (KF-90): 30 kg / 66 lbs 3 oz

Stand (FPS-9: Sold separately): 9.1 kg / 20 lbs 1 oz

Total: 39.1 kg / 86 lbs 4 oz

### Accessories

Owner's manual

Power Cord

DP-6

Music rest

Keyboard cover

Data Disk

\* *In the interest of product improvement, the specifications and/or appearance of this unit are subject to change without prior notice.*

# Index

## Numerics

16-Track Sequencer .....	118
5 Track buttons .....	97

## A

Advanced 3D .....	60
All Song Play .....	41
Ambience .....	142
Arrangement .....	78
Audio Equipment .....	160
Auto Punch In/Out .....	117
Automatic Accompaniment .....	28, 67

## B

Basic Screen .....	19
Balance .....	81
Bankselect .....	157
Basic Tempo .....	122
Bass Tone .....	146
Beat .....	65
Beat Map .....	122
Bend Range .....	148, 152
Bender Effect .....	148, 152
Blank Recording .....	116
Bouncing Ball .....	63
Break .....	148
Brilliance .....	17
Bwd (Backward) .....	83

## C

Calibration .....	155
Check It Out! .....	25
Chord Finder .....	69
Chord Intelligence .....	68, 147
Chord Sequencer .....	105
Chord Tone .....	146
Chords .....	68
Chorus Effect .....	152
Compatible .....	112
Computer .....	161
Contrast .....	153
Copy .....	125
Measure .....	125
Rhythm Pattern .....	126
Count Down .....	76
Count Sound .....	150
Count-In .....	88

## D

Data Disk .....	71
Delete .....	127
Songs .....	113
User Program .....	141
User Style .....	138
Demo .....	22
Disk drive .....	39
Divisions .....	67, 134
Drum Set .....	58
Drum Sounds .....	58
Dynamic Range .....	145

## E

Echo .....	44
Edit .....	124
Effect Sounds (SFX) .....	59
Effects .....	43, 62
Ending .....	67
Erase .....	129
Erasing a Recorded Song .....	102
EX Tones .....	24, 51
EZ Arranger .....	29

## F

Factory Reset .....	154
Fade In/Out .....	148
Fill-In .....	77
Fill In to Original .....	67
Fill In to Variation .....	67
Find Suitable .....	25
Floppy Disk .....	39, 109
Format .....	109
Write-protect tab .....	110
Fwd (Forward) .....	83

## G

General MIDI .....	183
Glide .....	148
GS .....	149, 183

## H

Harmonist .....	46
Headphones .....	17

## I

i-format .....	112
Index .....	25
Inputting Chords .....	107
Insert .....	128
Intro .....	67

## K

Karaoke .....	42
Key Touch .....	144
Key Transpose .....	93
Keyboard .....	48

## L

Language .....	153
Layer Play .....	53
Layer Part .....	53
Leading Bass .....	148
Local Control .....	157
Loop Recording .....	116
Lower .....	72
Lower Part .....	55
Lyric .....	153

## M

Manual Punch In/Out .....	117
Marker .....	90, 150
Moving a Marker .....	91
Master Tuning .....	151
Melody Intelligence .....	79
Memory Backup .....	154

# Index

---

Metronome .....	63
Animation .....	63
Beat .....	65
Sound .....	66
Tempo .....	64
Tempo Marks .....	64
Volume .....	66
MIDI .....	156
MIDI Devices .....	156
MIDI Ensemble .....	159
MIDI Sync .....	159
Mix Recording .....	116
Music Files .....	39
Music Style .....	67, 70
Mute .....	89
<b>N</b>	
Note Edit .....	130
<b>O</b>	
Octave Shift .....	57
One-touch Arranger .....	30
One-touch Piano .....	23, 50, 142
Opening Message .....	153
<b>P</b>	
Panel Lock .....	141
Panpot .....	121
Part Balance .....	81
Part Exchange .....	130
Parts .....	67, 118
Pattern .....	65
PC .....	124, 131
PC Edit .....	131
Pedal .....	16, 147
Piano Master .....	26
Piano Partner .....	95
Piano Tone .....	145
Pickup (PU) .....	104
Placing/Erasing a Marker .....	90
Playing Back Songs .....	83
Preset .....	70
Program Change .....	131, 157
PU (Pickup) .....	104
Punch-in Recording .....	117
<b>Q</b>	
Quantize .....	126
<b>R</b>	
Recording .....	36, 98, 100, 119
Recording Method .....	115
Redoing a Recording .....	101
Repeat .....	92
Replace Recording .....	116
Reset .....	75, 84
Resonance .....	144
Reverb Effect .....	59, 151
Rhythm Pattern .....	73, 108
Root Note .....	68
Rotary Slow/Fast .....	148

<b>S</b>	
Save .....	111
Save As SMF .....	112
Songs .....	109
User Programs .....	140
User Style .....	137
Score .....	84, 149
Screen Settings .....	153
Sequencer (16-Track Sequencer) .....	118
SFX .....	59
SMF .....	112
SMF Music files .....	183
Song Edit .....	124
Sound .....	66, 145
Split Play .....	55
Split Point .....	145
Stop .....	83
Stretch Tuning .....	143
Style Composer .....	132
Style Converter .....	134
Style Orchestrator .....	78
Sympathetic Resonance .....	142
Sync Start .....	74
<b>T</b>	
Tap Tempo .....	86
Tempo .....	85
Automatic Accompaniment .....	73
Metronome .....	64
Tempo Muting .....	87
Tempo Recording .....	123
Tone Set .....	120
Tones .....	24–25, 51
Track Button .....	89, 97, 101
Transformer .....	44
Transpose .....	
Keyboard .....	93, 128
Song .....	94
Tuning .....	143
Tuning Curve .....	143
TX. Channel .....	157
<b>U</b>	
Undo .....	124
Upper Part .....	55
User Program .....	138–139
User Style .....	71, 132
<b>V</b>	
Velocity .....	130
Virtual Jam .....	29
Vocal Count In .....	47
Volume .....	
Master .....	17
Metronome .....	66
Microphone .....	18
Volume Balance .....	81
<b>W</b>	
Write-protect tab .....	110

---

# MEMO

---

---

# MEMO

---



# Important Notes on Combining the KF-90 and FPS-9

To fasten the KF-90 piano to the FPS-9 stand, refer to the illustration below.

\* If the long knobbed bolts are mistakenly used for the holes at the front, it will be impossible to tighten the bolts properly.  
Be sure to use the appropriate bolts.

\* If you are combining the Roland FP-9 digital piano with the FPS-9 stand, use all four of the long knobbed bolts supplied with the FPS-9 stand.

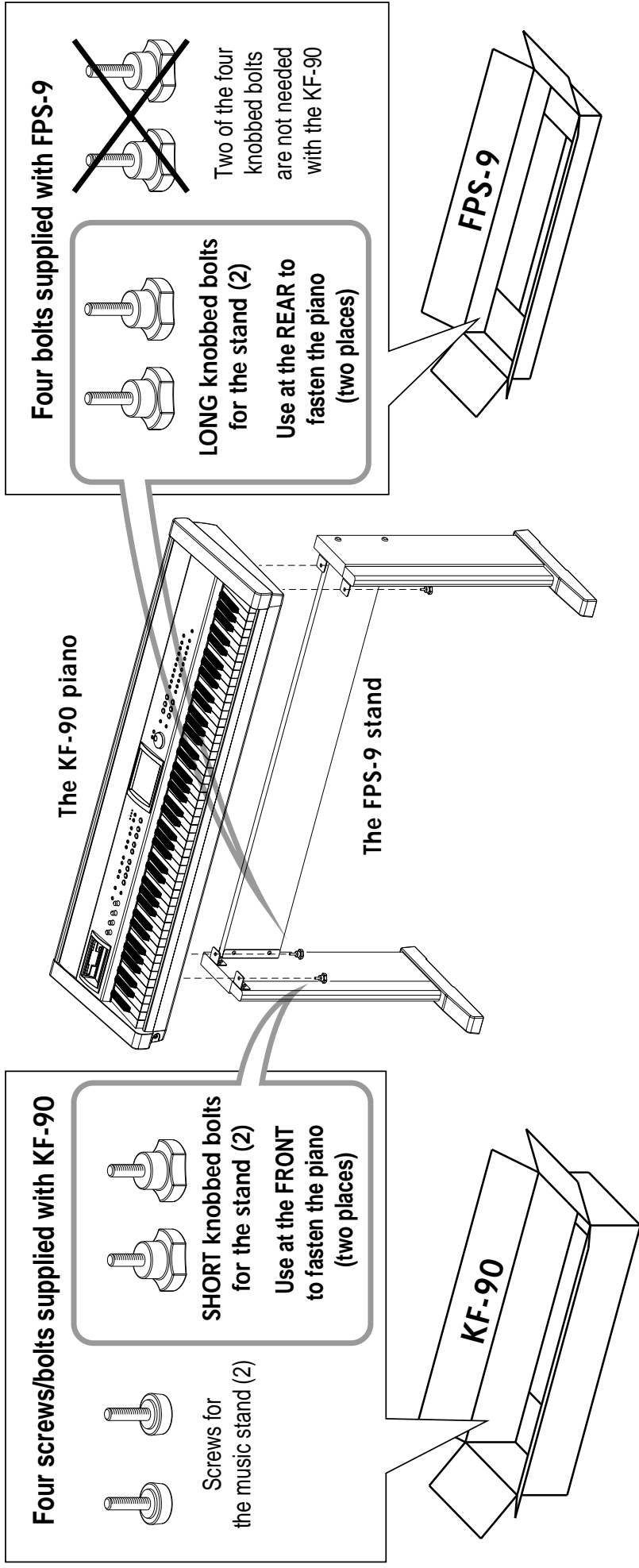





For EU Countries

This product complies with the requirements of European Directives EMC 89/336/EEC and LVD 73/23/EEC.

For the USA

## FEDERAL COMMUNICATIONS COMMISSION RADIO FREQUENCY INTERFERENCE STATEMENT

This equipment has been tested and found to comply with the limits for a Class B digital device, pursuant to Part 15 of the FCC Rules. These limits are designed to provide reasonable protection against harmful interference in a residential installation. This equipment generates, uses, and can radiate radio frequency energy and, if not installed and used in accordance with the instructions, may cause harmful interference to radio communications. However, there is no guarantee that interference will not occur in a particular installation. If this equipment does cause harmful interference to radio or television reception, which can be determined by turning the equipment off and on, the user is encouraged to try to correct the interference by one or more of the following measures:

- Reorient or relocate the receiving antenna.
- Increase the separation between the equipment and receiver.
- Connect the equipment into an outlet on a circuit different from that to which the receiver is connected.
- Consult the dealer or an experienced radio/TV technician for help.

Unauthorized changes or modification to this system can void the users authority to operate this equipment.  
This equipment requires shielded interface cables in order to meet FCC class B Limit.

For Canada

### NOTICE

This Class B digital apparatus meets all requirements of the Canadian Interference-Causing Equipment Regulations.

### AVIS

Cet appareil numérique de la classe B respecte toutes les exigences du Règlement sur le matériel brouilleur du Canada.

This owner's manual is printed on recycled paper.

**Roland Corporation**

02123634

'02-7-C2-61N