

Roland®

*FP*

## Digital Piano FP-9 Owner's Manual



Thank you, and congratulations on your choice of the Roland FP-9 Digital Piano.

**Before using this unit, carefully read the sections entitled: "IMPORTANT SAFETY INSTRUCTIONS" (p. 2), "USING THE UNIT SAFELY" (p. 3), and "IMPORTANT NOTES" (p. 4). These sections provide important information concerning the proper operation of the unit. Additionally, in order to feel assured that you have gained a good grasp of every feature provided by your new unit, this Owner's Manual should be read in its entirety. The manual should be saved and kept on hand as a convenient reference.**

- \* Apple is a registered trademark of Apple Computer, Inc.
- \* Macintosh is a registered trademark of Apple Computer, Inc.
- \* IBM PC/AT is a registered trademark of International Business Machines Corporation.

**Copyright © 1998 ROLAND CORPORATION**

All rights reserved. No part of this publication may be reproduced in any form without the written permission of ROLAND CORPORATION.

	<b>CAUTION</b> RISK OF ELECTRIC SHOCK DO NOT OPEN	
<b>ATTENTION:</b> RISQUE DE CHOC ELECTRIQUE NE PAS OUVRIR		
<p><b>CAUTION:</b> TO REDUCE THE RISK OF ELECTRIC SHOCK, DO NOT REMOVE COVER (OR BACK). NO USER-SERVICEABLE PARTS INSIDE. REFER SERVICING TO QUALIFIED SERVICE PERSONNEL.</p>		



The lightning flash with arrowhead symbol, within an equilateral triangle, is intended to alert the user to the presence of uninsulated "dangerous voltage" within the product's enclosure that may be of sufficient magnitude to constitute a risk of electric shock to persons.



The exclamation point within an equilateral triangle is intended to alert the user to the presence of important operating and maintenance (servicing) instructions in the literature accompanying the product.

INSTRUCTIONS PERTAINING TO A RISK OF FIRE, ELECTRIC SHOCK, OR INJURY TO PERSONS.

## IMPORTANT SAFETY INSTRUCTIONS SAVE THESE INSTRUCTIONS

**WARNING** - When using electric products, basic precautions should always be followed, including the following:

1. Read all the instructions before using the product.
2. Do not use this product near water — for example, near a bathtub, washbowl, kitchen sink, in a wet basement, or near a swimming pool, or the like.
3. This product should be used only with a cart or stand that is recommended by the manufacturer.
4. This product, either alone or in combination with an amplifier and headphones or speakers, may be capable of producing sound levels that could cause permanent hearing loss. Do not operate for a long period of time at a high volume level or at a level that is uncomfortable. If you experience any hearing loss or ringing in the ears, you should consult an audiologist.
5. The product should be located so that its location or position does not interfere with its proper ventilation.
6. The product should be located away from heat sources such as radiators, heat registers, or other products that produce heat.
7. The product should be connected to a power supply only of the type described in the operating instructions or as marked on the product.
8. The power-supply cord of the product should be unplugged from the outlet when left unused for a long period of time.
9. Care should be taken so that objects do not fall and liquids are not spilled into the enclosure through openings.
10. The product should be serviced by qualified service personnel when:
  - A. The power-supply cord or the plug has been damaged; or
  - B. Objects have fallen, or liquid has been spilled into the product; or
  - C. The product has been exposed to rain; or
  - D. The product does not appear to operate normally or exhibits a marked change in performance; or
  - E. The product has been dropped, or the enclosure damaged.
11. Do not attempt to service the product beyond that described in the user-maintenance instructions. All other servicing should be referred to qualified service personnel.

For the USA

### GROUNDING INSTRUCTIONS

This product must be grounded. If it should malfunction or breakdown, grounding provides a path of least resistance for electric current to reduce the risk of electric shock.

This product is equipped with a cord having an equipment-grounding conductor and a grounding plug. The plug must be plugged into an appropriate outlet that is properly installed and grounded in accordance with all local codes and ordinances.

**DANGER:** Improper connection of the equipment-grounding conductor can result in a risk of electric shock. Check with a qualified electrician or serviceman if you are in doubt as to whether the product is properly grounded.

Do not modify the plug provided with the product — if it will not fit the outlet, have a proper outlet installed by a qualified electrician.

For the U.K.

**WARNING:** THIS APPARATUS MUST BE EARTHED

**IMPORTANT:** THE WIRES IN THIS MAINS LEAD ARE COLOURED IN ACCORDANCE WITH THE FOLLOWING CODE.  
GREEN-AND-YELLOW: EARTH, BLUE: NEUTRAL, BROWN: LIVE

As the colours of the wires in the mains lead of this apparatus may not correspond with the coloured markings identifying the terminals in your plug, proceed as follows:

The wire which is coloured GREEN-AND-YELLOW must be connected to the terminal in the plug which is marked by the letter E or by the safety earth symbol  or coloured GREEN or GREEN-AND-YELLOW.

The wire which is coloured BLUE must be connected to the terminal which is marked with the letter N or coloured BLACK.



The wire which is coloured BROWN must be connected to the terminal which is marked with the letter L or coloured RED.

The product which is equipped with a THREE WIRE GROUNDING TYPE LINE PLUG must be grounded.







# USING THE UNIT SAFELY

## INSTRUCTIONS FOR THE PREVENTION OF FIRE, ELECTRIC SHOCK, OR INJURY TO PERSONS

### About WARNING and CAUTION Notices











 <b>WARNING</b>	Used for instructions intended to alert the user to the risk of death or severe injury should the unit be used improperly.
 <b>CAUTION</b>	Used for instructions intended to alert the user to the risk of injury or material damage should the unit be used improperly. * Material damage refers to damage or other adverse effects caused with respect to the home and all its furnishings, as well to domestic animals or pets.

### About the Symbols



	The  symbol alerts the user to important instructions or warnings. The specific meaning of the symbol is determined by the design contained within the triangle. In the case of the symbol at left, it is used for general cautions, warnings, or alerts to danger.
	The  symbol alerts the user to items that must never be carried out (are forbidden). The specific thing that must not be done is indicated by the design contained within the circle. In the case of the symbol at left, it means that the unit must never be disassembled.
	The  symbol alerts the user to things that must be carried out. The specific thing that must be done is indicated by the design contained within the circle. In the case of the symbol at left, it means that the power-cord plug must be unplugged from the outlet.

### ALWAYS OBSERVE THE FOLLOWING









#### **WARNING**

- Before using this unit, make sure to read the instructions below, and the Owner's Manual. 
- Do not open or perform any internal modifications on the unit. 
- Do not attempt to repair the unit, or replace parts within it (except when this manual provides specific instructions directing you to do so). Refer all servicing to your retailer, the nearest Roland Service Center, or an authorized Roland distributor, as listed on the "Information" page. 
- Never use or store the unit in places that are:
  - Subject to temperature extremes (e.g., direct sunlight in an enclosed vehicle, near a heating duct, on top of heat-generating equipment); or are 
  - Damp (e.g., baths, washrooms, on wet floors); or are 
  - Humid; or are
  - Exposed to rain; or are
  - Dusty; or are
  - Subject to high levels of vibration.
- When using the unit with a rack or stand recommended by Roland, the rack or stand must be carefully placed so it is level and sure to remain stable. If not using a rack or stand, you still need to make sure that any location you choose for placing the unit provides a level surface that will properly support the unit, and keep it from wobbling. 
- The unit should be connected to a power supply only of the type described in the operating instructions, or as marked on the unit. 
- Avoid damaging the power cord. Do not bend it excessively, step on it, place heavy objects on it, etc. A damaged cord can easily become a shock or fire hazard. Never use a power cord after it has been damaged. 
- This unit, either alone or in combination with an amplifier and headphones or speakers, may be capable of producing sound levels that could cause permanent hearing loss. Do not operate for a long period of time at a high volume level, or at a level that is uncomfortable. If you experience any hearing loss or ringing in the ears, you should immediately stop using the unit, and consult an audiologist. 
- Do not allow any objects (e.g., flammable material, coins, pins); or liquids of any kind (water, soft drinks, etc.) to penetrate the unit. 
- In households with small children, an adult should provide supervision until the child is capable of following all the rules essential for the safe operation of the unit. 

#### **WARNING**

- Protect the unit from strong impact. (Do not drop it!) 
- Do not force the unit's power-supply cord to share an outlet with an unreasonable number of other devices. Be especially careful when using extension cords—the total power used by all devices you have connected to the extension cord's outlet must never exceed the power rating (watts/amperes) for the extension cord. Excessive loads can cause the insulation on the cord to heat up and eventually melt through. 
- Before using the unit in a foreign country, consult with your retailer, the nearest Roland Service Center, or an authorized Roland distributor, as listed on the "Information" page. 

#### **CAUTION**

- The unit should be located so that its location or position does not interfere with its proper ventilation. 
- Always grasp only the plug on the power-supply cord when plugging into, or unplugging from, an outlet or this unit. 
- Try to prevent cords and cables from becoming entangled. Also, all cords and cables should be placed so they are out of the reach of children. 
- Never climb on top of, nor place heavy objects on the unit. 
- Never handle the power cord or its plugs with wet hands when plugging into, or unplugging from, an outlet or this unit. 
- If you need to move the instrument, take note of the precautions listed below. At least two persons are required to safely lift and move the unit. It should be handled carefully, all the while keeping it level. Make sure to have a firm grip, to protect yourself from injury and the instrument from damage. 
  - Check to make sure the knob bolts securing the unit to the stand have not become loose. Fasten them again securely whenever you notice any loosening.
  - Disconnect the power cord.
  - Disconnect all cords coming from external devices.
  - Remove the music stand.
- Before cleaning the unit, turn off the power and unplug the power cord from the outlet (p. 11). 
- Whenever you suspect the possibility of lightning in your area, pull the plug on the power cord out of the outlet. 

# IMPORTANT NOTES

In addition to the items listed under "IMPORTANT SAFETY INSTRUCTIONS" and "USING THE UNIT SAFELY" on pages 2 and 3, please read and observe the following:

## Power Supply

- Do not use this unit on the same power circuit with any device that will generate line noise (such as an electric motor or variable lighting system).
- Before connecting this unit to other devices, turn off the power to all units. This will help prevent malfunctions and/or damage to speakers or other devices.

## Placement

- This device may interfere with radio and television reception. Do not use this device in the vicinity of such receivers.
- Do not expose the unit to direct sunlight, place it near devices that radiate heat, leave it inside an enclosed vehicle, or otherwise subject it to temperature extremes. Also, do not allow lighting devices that normally are used while their light source is very close to the unit (such as a piano light), or powerful spotlights to shine upon the same area of the unit for extended periods of time. Excessive heat can deform or discolor the unit.
- To avoid possible breakdown, do not use the unit in a wet area, such as an area exposed to rain or other moisture.
- Do not allow rubber, vinyl, or similar materials to remain on the piano for long periods of time. Such objects can discolor or otherwise harmfully affect the finish.
- Do not put anything that contains water (e.g., flower vases) on the piano. Also, avoid the use of insecticides, perfumes, alcohol, nail polish, spray cans, etc., near the unit. Swiftly wipe away any liquid that spills on the unit using a dry, soft cloth.
- This device has built-in speakers. By putting floppy disks or the like on this device, you risk losing the data on them.
- By putting this device on a table or the like, it becomes hard to hear the sounds from the speakers on the bottom of it. Use the recommended stand (FPS-9; sold separately).

## Maintenance

- **The Wooden Parts (Both Ends of This Unit)**  
To clean the unit, use a dry, soft cloth. Try to wipe the entire surface using an equal amount of strength, moving the cloth along with the grain of the wood. Rubbing too hard in the same area can damage the finish.
- **The Other Parts**  
For everyday cleaning wipe the unit with a soft, dry cloth or one that has been slightly dampened with water. To remove stubborn dirt, use a cloth impregnated with a mild, non-abrasive detergent. Afterwards, be sure to wipe the unit thoroughly with a soft, dry cloth.
- Never use benzene, thinners, alcohol or solvents of any kind, to avoid the possibility of discoloration and/or deformation.

## Additional Precautions

- Use a reasonable amount of care when using the unit's buttons, sliders, or other controls; and when using its jacks and connectors. Rough handling can lead to malfunctions.
- When connecting / disconnecting all cables, grasp the connector itself—never pull on the cable. This way you will avoid causing shorts, or damage to the cable's internal elements.
- A small amount of heat will radiate from the unit during normal operation.
- To avoid disturbing your neighbors, try to keep the unit's volume at reasonable levels. You may prefer to use headphones, so you do not need to be concerned about those around you (especially when it is late at night).
- When you need to transport the unit, package it in the box (including padding) that it came in, if possible. Otherwise, you will need to use equivalent packaging materials.
- Do not apply excessive force to the front or back of the installed music stand.
- Use only the specified expression pedal (EV-5; sold separately). By connecting any other expression pedals, you risk causing malfunction and/or damage to the unit.

# CONTENTS

IMPORTANT SAFETY INSTRUCTIONS - - - - -	2
USING THE UNIT SAFELY - - - - -	3
IMPORTANT NOTES - - - - -	4
<b>INTRODUCTION - - - - -</b>	<b>6</b>
Features - - - - -	6
Printing Conventions in This Manual - - - - -	6
Panel Description - - - - -	7
<b>BEFORE YOU START PLAYING - - - - -</b>	<b>10</b>
Installing the Music Stand - - - - -	10
Pedal Connections and Functions - - - - -	10
Using Headphones - - - - -	10
Switching the Power On and Off - - - - -	11
Adjusting the Sound's Volume and Brilliance - - - - -	11
<b>LISTENING TO DEMO PLAY - - - - -</b>	<b>12</b>
<b>LET'S PLAY! - - - - -</b>	<b>13</b>
Playing with a Wide Variety of Sounds—An Introduction to Tones - - - - -	13
Playing Two Layered Tones—Dual Play - - - - -	14
Playing Different Tones with the Right and Left Keyboard Sections—Split Play - - - - -	14
Adding Breadth to Sounds—The Chorus Effect - - - - -	16
Adding Echo to Sounds—The Reverb Effect - - - - -	17
Playing in an Easier Key—Key Transpose - - - - -	18
Changing the Keyboard's Touch - - - - -	18
<b>OTHER FEATURES- - - - -</b>	<b>19</b>
Changing the Volume Balance for Dual Play and Split Play - - - - -	19
Changing the Amount of Resonance of the Damper Pedal - - - - -	19
Changing How the Pedals Work - - - - -	20
Setting Whether to Apply Effects to the Lower Tone - - - - -	20
Setting the Pitch of the Lower Tone in Octave Steps—Octave Shift - - - - -	21
Adjusting the Pitch to Match Another Instrument—Tuning - - - - -	21
<b>CONNECTING WITH AUDIO EQUIPMENT OR OTHER ELECTRONIC MUSICAL INSTRUMENTS - - - - -</b>	<b>22</b>
Playing Audio Equipment or Other Digital Instruments Through the FP-9's Speakers —The Line In Jacks and Line In Level Knob - - - - -	22
Playing Sounds from the FP-9 on an Audio Device or Using an Audio Device to Record What You Play —The Line Out Jacks and Line Out Volume Knob - - - - -	23
<b>IF YOU'RE CONNECTING THE FP-9 TO A MIDI INSTRUMENT - - -</b>	<b>24</b>
What's MIDI? - - - - -	24
How to Enjoy MIDI and the Steps for Making Connections - - - - -	24
Setting the Channels for Exchanging MIDI Messages - - - - -	25
Switching Local Control On and Off - - - - -	26
Sending Tone Change Information—Sending Program Change and Bank Select MSB or LSB Messages - - - - -	27
Setting the MIDI Mode - - - - -	29
<b>IF YOU'RE CONNECTING A COMPUTER - - - - -</b>	<b>30</b>
How to Enjoy and the Steps for Making Connections - - - - -	30
<b>APPENDICES - - - - -</b>	<b>32</b>
Trouble Shooting - - - - -	32
MIDI Implementation Chart - - - - -	33
Specifications - - - - -	34
Index - - - - -	35
Service Information - - - - -	36

# INTRODUCTION

## Features

### Authentic Piano Performances

The high-quality concert-piano sounds and authentic hammer-action keyboard let you enjoy piano performances that are even more realistic.

### 24 Types of Tones You Can Use in a Wide Range of Genres

In addition to piano tones, the FP-9 offers 24 types of high-quality built-in tones that you can use in a wide range of musical genres.

### A Richly Expressive Hammer-action Keyboard

Thanks to a mechanism that uses only the mass of the hammers to return the keys, you can obtain a natural, smooth, and delicate touch for pianissimo playing, and a strong, sure response with fortissimo play.

### Keyboard Touch Can Be Set to Match Finger Strength

You can set the keyboard touch to any of three levels to suit the finger strength of the player.

### Onboard Effects

Two digital effects—Chorus and Reverb—are built in. The FP-9 also has an on-board effect for piano tones that makes the sound of the played key resonate with other strings, adding rich reverberations and broadness to the sound (sympathetic resonance).

### Dual Feature for Combining Two Tones

You can freely combine two tones from any of eight Tone groups, achieving layered play.

### Playing Different Tones with the Left and Right Hands with the Split Feature

You can divide the keyboard at a particular key into right- and left-hand sections that play different tones.

### Lightweight and Compact, with a Casual, Modern Design

The FP-9's light weight and compact size make for excellent portability.

The casual, modern design also matches the decor of any room.

### Small Number of Buttons Keeps Operation Simple

As far as possible, buttons that aren't for tone selection have been eliminated, thus achieving simple operation.

### Built-in Speakers

Not only can you enjoy the rich sounds of the FP-9 right away, this useful feature allows you to play live at parties and small venues, or to use the FP-9 as an on-stage monitor.







### Connect Audio Equipment, MIDI Instruments, and Computers

The FP-9 comes with Line In and Line Out jacks, MIDI connectors, and computer ports that let you use it in combination with other audio devices, electronic instruments, and computers.

## Printing Conventions in This Manual

### Distinguishing Lighted, Dark, and Flashing Button Lights

This manual uses the following conventions to distinguish between lights that are illuminated (color: orange, red, or green), dark, or flashing (color: orange, red, or green).

light status \ light color	Orange	Green	Red
illuminated	 Orange	 Green	 Red
dark			
flashing	 Orange	 Green	 Red

### Conventions for Button Names

Each of the buttons on the unit's front panel is labeled above and below. (For example, the word "Split" could appear above a button, while the word "Local" appears below it.)

The upper text denotes the button's usual function.

The lower text denotes the extended function that's called up when you press the button (p. 9).

In this manual, when a button is to be used for the function denoted by the upper text, it's enclosed in square brackets ("[]"), like this: [Split] button.

When a button is to be used for the function denoted by the lower text, it's enclosed in angled brackets ("<<>>"), like this: <<Local>> button.

---

## Panel Description

---

### Rear Panel

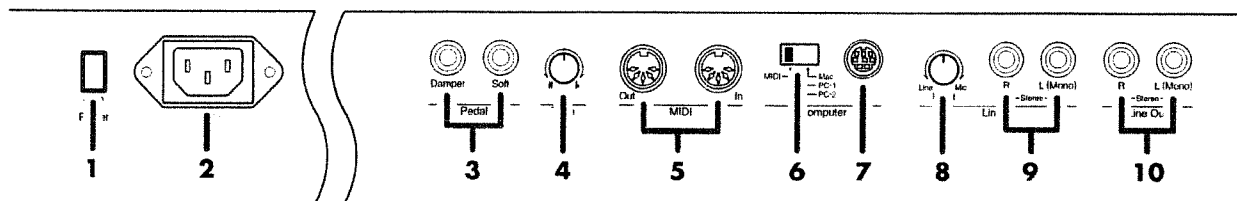

#### 1. [Power] Switch

This switches the power on and off (p. 11).

#### 2. AC Inlet

This is for plugging in the power cord that comes with the FP-9 (p. 11).

#### 3. Pedal Jacks

These are for the supplied pedal (DP-6) and others (p. 10). When connected to Damper, the pedal functions as a damper pedal (p. 10).

When connected to Soft, the pedal functions as a soft pedal (p. 10).

#### 4. Tune Knob

You can use this knob to tune the FP-9 to match the pitch of other instruments for ensemble play (p. 21).

#### 5. MIDI Connectors

Connect between these and external MIDI instruments to exchange performance information (p. 24).

#### 6. Computer Switch

This switches the connections for the MIDI connectors and the computer port (p. 25, 30).

Also, this switch is set to Mac, PC-1, or PC-2 according to the type computer that's connected (p. 31).

#### 7. Computer Connector

You can connect a computer to this jack to exchange performance information (p. 30).

#### 8. Line In Level Knob

This adjusts the input level (volume) of connected audio equipment or other digital instruments (p. 22).

#### 9. Line In Jacks

You can connect audio equipment or other digital instruments and hear them through the FP-9's speakers (p. 22).

#### 10. Line Out Jacks

You can use these to play the notes from the FP-9 on an audio device or record what you play on a tape recorder (p. 23).

---

## Front Panel

---

---

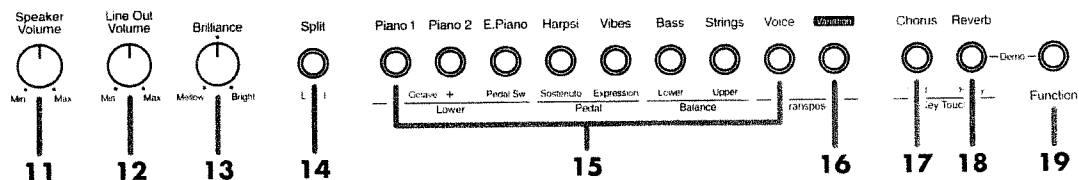

### 11. [Speaker Volume] Knob

This adjusts the volume level for the unit's internal speakers (p. 11).

### 12. [Line Out Volume] Knob

When audio equipment or other digital instruments are connected, this adjusts the level of output to the connected equipment (p. 23).

### 13. [Brilliance] Knob

This adjusts the sound's brilliance (p. 11).

### 14. [Split] Button

You can use this to divide the keyboard into right-hand and left-hand sections that each play different tones (p. 14).

### 15. Tone Buttons

These choose the sound the keyboard plays (p. 13). There are buttons for eight different Tone Groups.

### 16. [Variation] Button

Used to choose a tone from a Tone Group (p. 13).

### 17. [Chorus] Button

You can use this to add three-dimensional breadth and "fatness" to sounds (p. 16).

### 18. [Reverb] Button

You can use this to add the same echoes as in a concert hall to what you play (p. 17).

### 19. <<Function>> Button

You can call up a particular button's extended function by pressing this button, then pressing the other button (p. 9). The label under each button shows its extended function (such as "Local").

You can call up MIDI-related extended functions (p. 24) by holding down this button and pressing a key (p. 9).



## Functions of the <<Function>> Button—Extended Functions

By pressing the <<Function>> button, then pressing one of the buttons described below, you can call up the extended function whose name appears under each of the buttons.

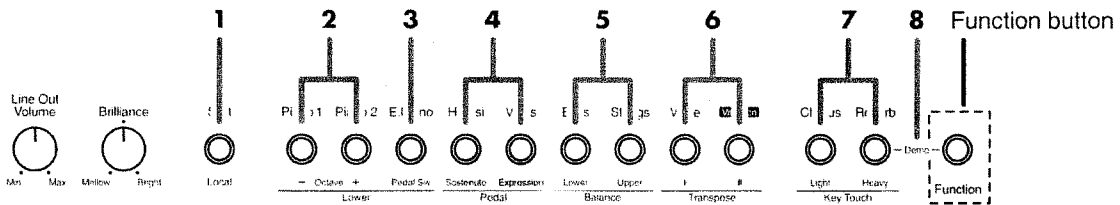

### 1. <<Local>> (Local Control On/Off)

You can use this to toggle Local Control on or off (p. 26).

### 2. Lower <<Octave ->>/<<Octave +>>

This lets you set the lower tone interval in octave steps (Octave Shift; p. 21).

### 3. Lower <<Pedal Sw>> (Lower Pedal Switch)

You can use this to set whether pedal effects are applied to lower tones (p. 20).

### 4. Pedal <<Sostenuto>>/<<Expression>>

This lets you use the sostenuto pedal and expression pedal functions (“Changing How the Pedals Work,” p. 20).

### 5. Balance <<Lower>>/<<Upper>>

You can use this to change the volume balance for dual play or split play (p. 19).

### 6. Transpose <<♭>>/<<♯>>

You can transpose the key of a performance without having to shift the position of your fingers on the keyboard (p. 18).

### 7. Key Touch <<Light>>/<<Heavy>>

This lets you vary the keyboard’s touch (p. 18).

### 8. Demo

You can listen to demonstrations using the FP-9’s tones (p. 12). In this case only, the operation is to hold down the <<Function>> button and press the [Reverb] button.

**You can call up a MIDI-related extended function (p. 24) by holding down the <<Function>> button and pressing any of the keys.**

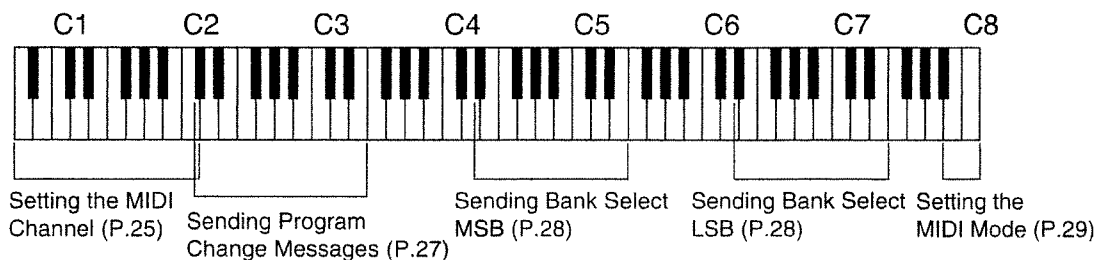

# BEFORE YOU START PLAYING

## Installing the Music Stand

Install the music stand that comes with the FP-9.

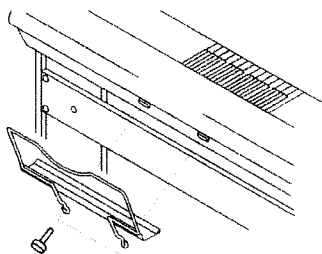

1. Using the supplied screws, fasten the music stand to the back of the FP-9 as shown at left.

Turn the screws clockwise to tighten them.

2. To remove the music stand, support it with one hand while loosening the screws.



Do not apply excessive force to the front or back of the installed music stand.

## Pedal Connections and Functions

Connect the supplied pedals (DP-6) to the Damper and Soft pedal jack at the back of the unit.

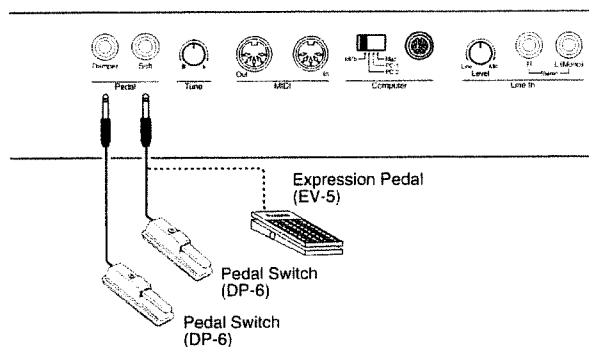

When connected to Damper or Soft, the pedal functions (see the table at right).

Damper	The pedal works as a damper pedal, so you can add lingering reverberations to notes. While the pedal is depressed, long lingering reverberations continue to be added to the sound after you release from the keys.
Soft	The pedal works as a soft pedal, so you can make notes softer. Playing the keyboard while the pedal is depressed makes the sounded notes softer than when you finger them with the same velocity in the normal manner, without the pedal.



You can also use Soft as a sostenuto or expression pedal. Take a look at "Changing How the Pedals Work" (p. 20).



When you connect pedals to both the Damper and Soft pedal jacks, you can use the two functions at the same time. To do this, you need to purchase another pedal (DP-6).



Unplugging a pedal cord from the unit while the power is on may cause the pedal's effect to be applied without stopping. Be sure to switch off the power to the unit before attempting to disconnect or connect a pedal cord.

## Using Headphones

The unit's speakers will go silent when you plug in headphones (RH-20/80/120 or the like; sold separately). This makes it convenient for playing at night, or at other times when you do not want to disturb others.

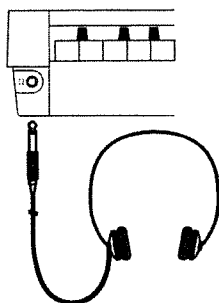

1. Plug the headphones into the Phones jack at the front, on the left side of the piano.

The sound from the built-in speakers stops. Now, sound is heard only through the headphones.

2. Use the [Speaker Volume] knob on the FP-9 to adjust the volume of the headphones.



Stereo headphones such as the RH-20/80/120 Stereo Headphones from Roland should be used.

### Some Notes on Using Headphones

- To prevent damage to the cord, handle the headphones only by the headset or the plug.
- The headphones may be damaged if the volume is too high when they are plugged in. Lower the volume on the FP-9 before plugging in the headphones.
- To prevent possible auditory damage, loss of hearing, or damage to the headphones, the headphones should not be used at an excessively high volume. Use the headphones at a moderate volume level.

---

## Switching the Power On and Off

---

Be sure to follow the steps below when turning the power on or off.

If this is not done in the correct sequence, you risk causing a malfunction, and/or damage to speakers and other equipment.

### Turning On the Power

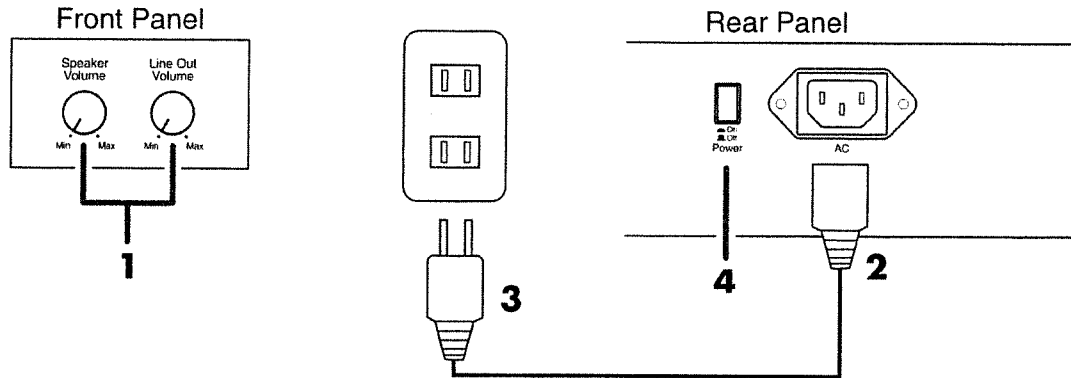

1. Before you switch on the power, adjust the [Speaker Volume] and [Line Out Volume] knobs to Min (minimum).
2. Connect the supplied power cord to the AC inlet on the back of the unit.
3. Plug the supplied power cord into an AC outlet.
4. Press the [Power] switch on the back of the unit. After a few seconds, the unit will be operable, and playing the keyboard will produce sound.

■ On (Turning on the power)

5. Use the [Speaker Volume] knob to adjust the volume level. (See "Adjusting the Sound's Volume and Brilliance" below.)

**NOTE**

This unit is equipped with a protection circuit. A brief interval (a few seconds) after power up is required before the unit will operate normally.

**NOTE**

Be sure to use only the power cord supplied with the FP-9.

### Turning Off the Power

1. Before you switch off the power, adjust the [Speaker Volume] and [Line Out Volume] knobs to Min (minimum).
2. Press the [Power] switch on the back of the unit.

The power is switched off.

■ Off (Turning off the power)

---

## Adjusting the Sound's Volume and Brilliance

---

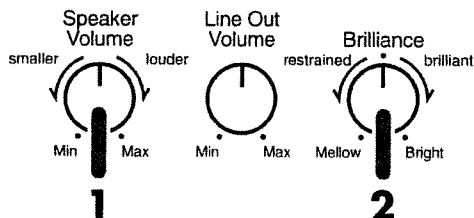

1. Use the [Speaker Volume] knob to adjust the overall volume level.

Turning the knob toward Max increases the volume, and turning it toward Min lowers it.

2. Use the [Brilliance] knob to adjust the overall sound quality.

Turning the knob toward Bright makes the sound more brilliant, and turning it toward Mellow makes it more restrained.

# LISTENING TO DEMO PLAY

Some demonstrations that use the FP-9's tones are built in. You can play them automatically.

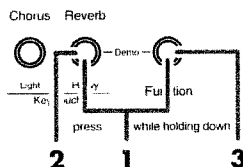

1. Hold down the <<Function>> button and press the [Reverb] button.

The indicator lights for the <<Function>> button and the [Reverb] button flash in orange.

Playback of the demos starts with the first song. When playback of the last song finishes, it starts over again from the first song.

2. Press the [Reverb] button to start playback of the next song.
3. Press the <<Function>> button again to stop playback of the demo songs.

The lights for the <<Function>> button and the [Reverb] button go dark.

## You can start playback from a selected song.

Together press, and continue holding down the <<Function>> and [Reverb] buttons. The Tone button indicator lights for the available songs will light up. The Tone buttons correspond, from left to right, to song numbers 1, 2, 3, 4, and 5. The indicator light for only the Tone button corresponding to the presently selected tune flashes.

To select a song, hold down the <<Function>> and [Reverb] buttons and press any one of the lighted Tone buttons. When you release the <<Function>> and [Reverb] buttons, playback starts from the selected song. When playback of the last song finishes, it starts over again from the first song.

## Demo Song List

Song number	Song name	Composer
1.	Hidden Ravine	Scott Wilkie *1
2.	Breathin' Fingers	Scott Wilkie *1
3.	Blue Thermal Glass	Scott Wilkie *1
4.	Short Stories	Stephane Pigeon *2
5.	Sault D'Amour Op. 12	E. Elgar

\*1: Copyright © 1998 Scott Wilkie Media (ASCAP)

\*2: Copyright © 1998 Roland Corporation

\* All rights reserved. Unauthorized use of this material for purposes other than private, personal enjoyment is a violation of applicable laws.

\* No data for the music that is played will be output from MIDI Out.

## Profiles of composers

### Scott Wilkie

Scott Wilkie is a contemporary jazz recording artist, based in southern California. He tours frequently with his own band, and also appears as an artist for Roland in the U.S., Japan, Europe and South America. His debut solo album, *Chasing The Dream*, will be released worldwide in 1999 on Narada/Virgin Records. You can find him on-line at [www.scottwilkie.com](http://www.scottwilkie.com).

### Stephane Pigeon

For more than 10 years, Stephane Pigeon studied classical piano, as well as chamber music and harmony, at the Woluwe-Saint-Pierre Music Academy in Brussels. He graduated in electrical engineering from the Catholic University of Louvain, and attended instrument technology lessons at the music department. He currently works as a research engineer in signal processing, but still devotes a lot of time to music, his favorite activity. He started his collaboration with Roland Corporation as a sound designer. He has been involved in many projects, including the programming of factory presets for the JD, JV, XP and JP series.

# LET'S PLAY!

## Playing with a Wide Variety of Sounds—An Introduction to Tones

The FP-9 has 24 built-in tones that are divided into eight groups according to their type. The tone is set at “Full Grand 1” when the FP-9 is powered up.

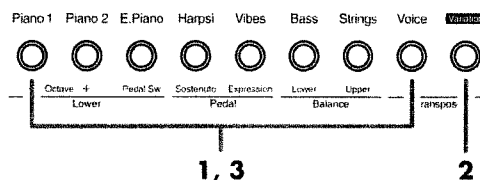

1. Press any one of the Tone buttons to choose the Tone Group.  
The tone for the selected Tone Group sounds. Try fingering the keyboard.  
When you turn on the power, the tone indicated by the orange light for any of the Tone Groups sounds (take a look at the “Tone List” below).
2. Press the [Variation] button to choose one of the tones in the Tone Group.

The indicator lights for the selected Tone button flash, showing that a tone has been chosen.

Each press of the [Variation] button changes the color of the Tone button’s light and the Tone button’s tone.

The “Tone List” below shows the correspondences between the color of a Tone button’s indicator light and the button’s tone.

3. Finger the keyboard or press the flashing Tone button.  
The Tone button indicator lights up, and fingering the keyboard plays the tone you’ve chosen.  
The next time you choose this Tone button, the tone you’ve selected here is played.

### Tone List

For more information about tones, take a look at the “Description of Tones” below.

Light color	Tone Group							
	Piano 1	Piano 2	E.Piano	Harpsi	Vibes	Bass	Strings	Voice
Orange	Full Grand 1	Pop Piano	Stage Rhodes	Harpsichord	Vibraphone	Ac.Bass	Orch.Strings	Jazz Scat
Green	Full Grand 2	Classic Piano	SA Rhodes	Clav 1	Marimba	Finger Bass	Synth Strings 1	Choir 1
Red	Honky-Tonk	Rock Piano	FM E.Piano	Clav 2	Glockenspiel	Voice Bass	Synth Strings 2	Choir 2

\* There are some key ranges in Ac.Bass, Finger Bass, and Voice Bass that do not sound.

\* The way the soft pedal effect is applied may differ according to the tone.

### Description of Tones

Full Grand 1	This is the sound of a full concert grand piano. It offers rich reverberations in stereo.
Full Grand 2	This is the sound of a full concert grand piano. You can sound up to 64 notes at the same time.
Honky-Tonk	This is the sound of a slightly detuned piano with a bright, enjoyable ambience.
Pop Piano	This is a prominent, bright piano sound. It’s ideal for popular music and band play.
Classic Piano	This is a restrained piano with a European feel. It’s optimal for classical performances.
Rock Piano	This is a piano sound with a prominent attack. It’s ideal for rock music and band play.
Stage Rhodes	This is an old-style Rhodes piano sound.
SA Rhodes	This is a Rhodes piano sound. The sound is broad, yet has clarity and sweetness.
FM E.Piano	This is the electric-piano sound of a synthesizer.
Harpsichord	This is a delicate and refined harpsichord sound.
Clav 1, 2	This is the sound of an instrument that boosts the vibration of a plucked string with an amp. It’s optimal for rhythmical play.
Vibraphone	This is the sound of a large carillon called a vibraphone.
Marimba	This is the sound of a large xylophone called a marimba.
Glockenspiel	This is the sound of a small carillon called a glockenspiel.
Ac.Bass	This is the sound of an acoustic bass.
Finger Bass	This is the sound of a fingered electric bass.
Voice Bass	This is the sound of a jazz-scat bass part.
Orch.Strings	This is the sound of a beautiful strings ensemble.
Synth Strings 1, 2	This is the sound of synthesizer strings with a slow attack.
Jazz Scat	This tone can be divided into four types of voices according to the velocity with which you finger the keyboard. It’s optimal in combination with Voice Bass during split play.
Choir 1, 2	This is a choir sound. It imparts a stately mood.

## Playing Two Layered Tones—Dual Play

You can play two different sets of sounds from a single key at the same time. This method of play is called “dual play.”

### Example: Let’s combine the tones for piano and strings.

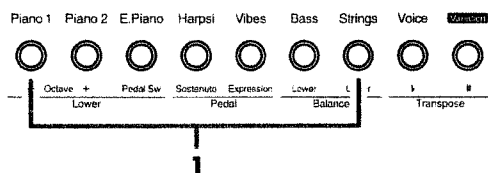

1. Press the [Piano1] button and the [Strings] button at the same time.

Both buttons light up.

Try fingering the keyboard. The piano and strings tones play at the same time.

In this way, pressing two Tone buttons at the same time plays the two tones in combination. In dual play, the tone of the right button you press is called the “upper tone,” and the tone of the left button is called the “lower tone.” In this example, the strings sound is the upper tone and the piano sound is the lower tone.

2. Press either one of the Tone buttons to cancel dual play. Now only the tone of the button you just pressed is sounded.

### You can swap the upper tone and lower tone.

**Example: Change the piano sound to the upper tone, and the strings sound to the lower tone.**

During dual play with the piano and strings sounds, simultaneously press the [Piano1] and [Strings] buttons a second time. The piano sound becomes the upper tone, and the strings sound becomes the lower tone.

Each time you press the [Piano1] and [Strings] buttons at the same time, the upper tone and lower tone are swapped.



You can vary the volume-level balance of the two tones. Take a look at “Changing the Volume Balance for Dual Play and Split Play” (p. 19).



You can change the pitch of the lower tone by octaves. Check out “Setting the Pitch of the Lower Tone in Octave Steps—Octave Shift” (p. 21).



During dual play, depressing a pedal applies its effect only to the upper tone. If you want to apply the effect to the lower tone as well, check out “Setting Whether to Apply Effects to the Lower Tone” (p. 20).

## Playing Different Tones with the Right and Left Keyboard Sections—Split Play

You can divide the keyboard into right- and left-hand sections with an arbitrary key marking the division, and play different tones with each hand. This kind of play with the keyboard divided into right- and left-hand sections is called “split play,” and the location where the division is made is called the “split point.”

When you switch on the power, the split point is at “C4.” The split-point key belongs to the right-hand section.

The notes you play with the right-hand section are called “upper tones,” and the notes you play with the left-hand section are called “lower tones.”

### Example: Let’s try split play with the Full Grand 1 tones.

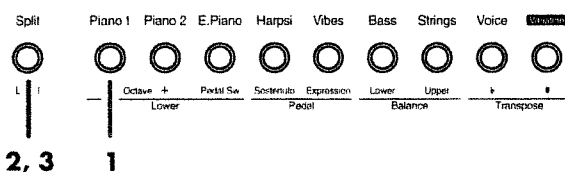

1. Press the [Piano 1] button to make the button’s indicator light up in orange.

Now the tones for Full Grand 1 are selected.

\* If the button light isn’t orange, press the [Variation] button to make the button indicator light up in orange.

2. Press the [Split] button to make the indicator light up. This splits the keyboard into right-hand and left-hand sections at C4.

The right-hand section of the keyboard plays Full Grand 1 tones, and the left-hand section plays Ac. Bass (acoustic bass) tones.

The tone that was sounded before you divided the keyboard is chosen for the right-hand section (the upper tone), and an optimal match for this upper tone is chosen automatically for the left-hand section (the lower tone).

\* When changing from dual play (p. 14) to split play, the upper tone during dual play is selected as the upper tone for split play, too.

3. Pressing the [Split] button again cancels split play.

The [Split] button indicator light goes dark and the upper tone (Full Grand 1) becomes the tone for the entire keyboard.

## Changing the Tones Played

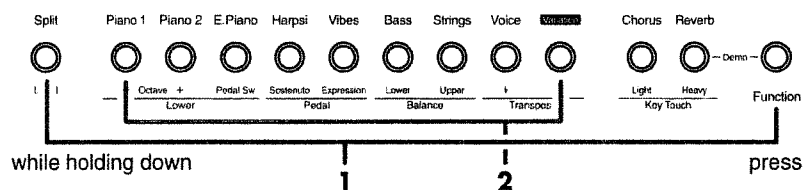

1. Hold down the [Split] button and press the <<Function>> button to choose whether to change the tone of the right-hand section (the upper tone) or the tone of the left-hand section (the lower tone).

Each press of the <<Function>> button while holding down the [Split] button changes the color of the [Split] button's indicator light.

The tone you can change switches in correspondence with the color of the [Split] button indicator light.

Color of the [Split] button light	Tone you can change
Orange	Upper Tone
Green	Lower Tone

You can also choose the tone to change by continuing to hold down the [Split] button.

- \* If the sound is no longer heard after you press the [Split] button, it could mean that Local Control has been switched off (see p. 26). If this is the case, set Local Control to "on."

2. Use the Tone buttons and the [Variation] button to choose a tone.

For information on how to choose a tone, take a look at "Playing with a Wide Variety of Sounds—An Introduction to Tones" (p. 13).

### Canceling Split Play

A newly selected lower tone gets stored in memory as being the lower tone that goes with the upper tone being used at that time. The next time you change to split play while that upper tone is selected, the tone you've stored in memory here is sounded as the lower tone. The lower tone stored in memory remains in effect until you turn off the power.



You can change the split point. Take a look at "Changing the Keyboard's Split Point" (p. 15).



You can change the volume balance for the upper and lower tones. Take a look at "Changing the Volume Balance for Dual Play and Split Play" (p. 19).



You can change the pitch of the lower tone one octave at a time. Check out "Setting the Pitch of the Lower Tone in Octave Steps—Octave Shift" (p. 21).



Depressing a pedal during split play applies its effect only to the upper tone. If you want to apply the effect to the lower tone as well, check out "Setting Whether to Apply Effects to the Lower Tone" (p. 20).

## Changing the Keyboard's Split Point

You can change the location where the keyboard is divided (the split point) within the range of C2 through C6.

The setting is at "C4" when the FP-9 is powered up.

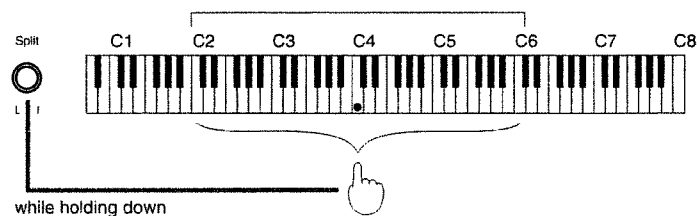

1. Hold down the [Split] button and press a key.

The key you pressed becomes the split point, and belongs to the right-hand section of the keyboard.

## Adding Breadth to Sounds—The Chorus Effect

You can apply a chorus effect to the notes you play on the keyboard. Applying chorus can add greater dimension, for a “fat” sound.

You can choose any of eight types for the depth of the chorus effect.

### Example: Let’s apply chorus to the Vibraphone tone.

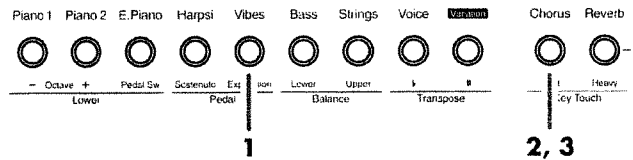

1. Press the [Vibes] button to make the button’s indicator light up in orange.

Now the Vibraphone tone is selected.

\* If the button light isn’t orange, press the [Variation] button to make the button indicator light up in orange.

2. Press the [Chorus] button to make the button’s indicator light up in orange.

Try fingering the keyboard.

The chorus effect is applied to the currently selected tone.

3. Pressing the [Chorus] button again to make the button’s indicator light go dark cancels the chorus effect.



Some tones initially have chorus applied. Selecting such a tone makes the [Chorus] button indicator light up automatically.



Whether or not chorus is to be applied can be set individually for each tone.

## Choosing the Depth of the Chorus Effect

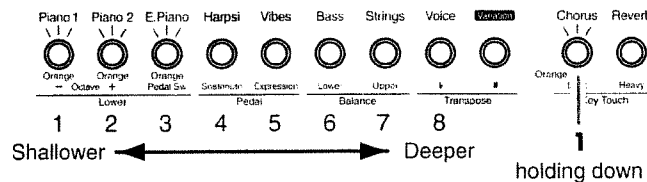

The further toward “Deeper” that the flashing Tone button lights go, the greater the depth of the effect.

1. Holding down the [Chorus] button continuously will show you the depth of the currently selected chorus effect.

The [Chorus] button’s indicator light and the indicator lights for the Tone buttons flash in orange.

The number of flashing Tone buttons indicates the depth of the chorus effect.

The relationship between the Tone buttons and the chorus depth is shown above.

2. Hold down the [Chorus] button and press one of the Tone buttons to select the depth of the effect.

You can also choose the depth of the effect by holding down the [Chorus] button and pressing the [Variation] button.

The next time you choose the same tone, the chorus effect with the depth you’ve selected here is applied.



At powerup, the optimum effect depth settings are placed in effect for each tone.



During dual or split play, the chorus effect applied to the lower tone will have the same depth as that set for the upper tone.



If you change the depth of the chorus effect while you have the lower tone selected during split play, the setting is stored in memory for the upper tone.



## Adding Echo to Sounds—The Reverb Effect

You can apply a reverb effect to the notes you play on the keyboard. Applying reverb adds pleasing reverberations to what you play, almost as if you were playing in a concert hall.

You can choose any of eight types for the depth of the reverb effect.

### Example: Let's apply reverb to the Vibraphone tone.

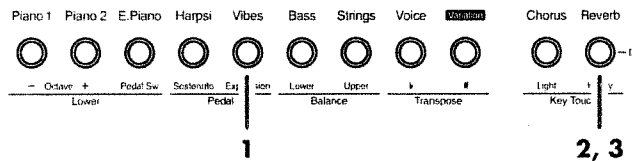

1. Press the [Vibes] button to make the button's indicator light up in orange.

Now the Vibraphone tone is selected.

\* If the button light isn't orange, press the [Variation] button to make the button indicator light up in orange.

2. Press the [Reverb] button to make the indicator light up in orange.

Try fingering the keyboard.

The reverb effect is applied to the currently selected tone.

3. Pressing the [Reverb] button again to make the button's indicator light go dark cancels the reverb effect.



Some tones initially have reverb applied. Selecting such a tone makes the [Reverb] button indicator light up automatically.



Whether or not reverb is to be applied can be set individually for each tone.

## Choosing the Depth of the Reverb Effect

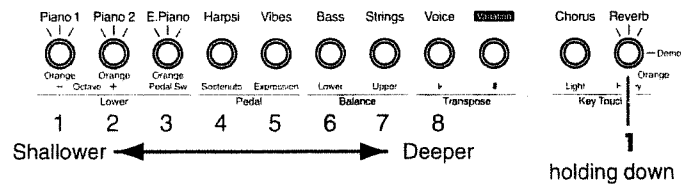

The further toward "Deeper" that the flashing Tone button lights go, the greater the depth of the effect.

1. Holding down the [Reverb] button continuously will show you the depth of the currently selected reverb effect.

The [Reverb] button's indicator light and the indicator lights for the Tone buttons flash in orange.

The number of flashing Tone buttons indicates the depth of the reverb effect.

The relationship between the Tone buttons and the reverb depth is shown above.

2. Hold down the [Reverb] button and press one of the Tone buttons to select the depth of the effect.

You can also choose the depth of the effect by holding down the [Reverb] button and pressing the [Variation] button.

The next time you choose the same tone, the reverb effect with the depth you've selected here is applied.



At powerup, the optimum effect depth settings are placed in effect for each tone.



During dual or split play, the reverb effect applied to the lower tone will have the same depth as that set for the upper tone.



If you change the depth of the reverb effect while you have the lower tone selected during split play, the setting is stored in memory for the upper tone.

## Playing in an Easier Key—Key Transpose

You can transpose the key of a performance without having to shift the position of your fingers on the keyboard. This feature is called “Key Transpose.”

This lets you take a song in a difficult key with lots of sharps and flats, and play it in a key with fingering that’s easier for you. For instance, you can play a tune in the key of E major with the keyboard fingering for the key of C major. This is handy when playing accompaniment to a song, to match what you play to the pitch of the singer’s voice.

You can transpose by an amount down six half-steps or up five half-steps.

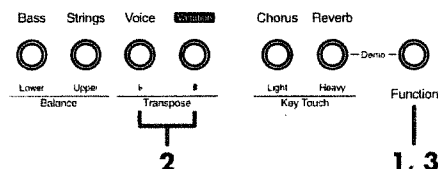

1. Press the <<Function>> button to make the indicator light flash in red.
2. Each press of the <<Transpose ♭>> button lowers the pitch by a semitone. Each press of the <<Transpose #>> button raises the pitch by a semitone.

At this time, the indicator light for the <<Transpose ♭>> or <<Transpose #>> button lights up in red.

Transposing the pitch six half-steps down makes the <<Transpose ♭>> button’s indicator light flash in red.

Transposing the pitch five half-steps up makes the <<Transpose #>> button flash in red.

If you want to go back to the original key, press the <<Transpose ♭>> button and the <<Transpose #>> button at the same time to make both indicator lights go dark.

3. Press the <<Function>> button to make the indicator light go dark.



The transposition setting remains in effect until you turn off the power.

### Example: Let’s take a song in the key of E major and play it in the key of C major.

We’ll consider the C note in the key of C major to be the basic note. From the C note to the E note that corresponds to C in the key of E major there are four keys on the keyboard, counting the black ones, so press the <<Transpose #>> button four times.

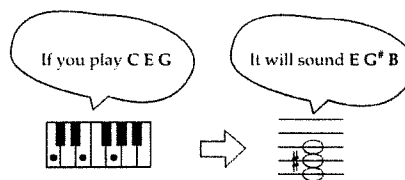

## Changing the Keyboard’s Touch

You can change the keyboard’s touch.

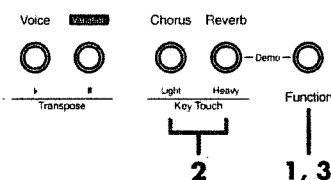

1. Press the <<Function>> button to make the indicator light flash in red.
2. Use the Key Touch <<Light>> and <<Heavy>> buttons to choose the keyboard’s touch (see the figure at right).
3. Press the <<Function>> button to make the indicator light go dark.

### Light

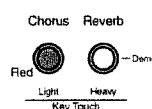

Press the Key Touch <<Light>> button to make the button’s indicator light up in red. This imparts a lighter feel to the keyboard. Because stronger notes can be produced with touch of less than standard force, this setting makes it easy for children or other players lacking strength to play.

### Heavy

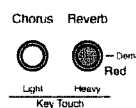

Press the Key Touch <<Heavy>> button to make the button’s indicator light up in red. This imparts a heavier feel to the keyboard. Because stronger notes cannot be produced unless played with greater than standard force, it allows for more dynamics to be used when playing.

### Standard

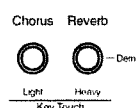

Press the Key Touch <<Light>> or <<Heavy>> button to make the indicator lights for both buttons go dark. This makes the setting for standard touch.



At powerup, the piano is set to standard touch.

# OTHER FEATURES

## Changing the Volume Balance for Dual Play and Split Play

You can change the volume balance for the upper and lower tones in dual play or split play.

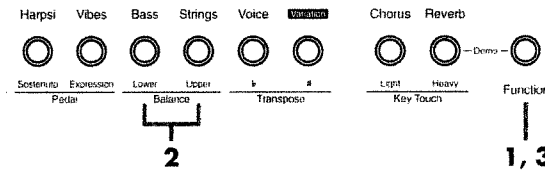

1. Press the <<Function>> button to make the indicator light flash in red.
2. Each press of the Balance <<Upper>> button makes the upper-tone volume larger than the lower-tone volume, and each press of the Balance <<Lower>> button makes the lower-tone volume larger than the upper-tone volume.

At this time, the indicator light for the Balance <<Upper>> or Balance <<Lower>> button lights up in red.

When the upper tone is at maximum volume, the Balance <<Upper>> button's indicator light flashes in red.

When the lower tone is at maximum volume, the Balance <<Lower>> button's indicator light flashes in red.

If you want to go back to the standard volume balance, press the Balance <<Upper>> and <<Lower>> buttons at the same time to make the indicator lights for both buttons go dark.

3. Press the <<Function>> button to make the indicator light go dark.



If you've raised the volume level of the lower tone, returning to normal play (that is, playing with a single tone for the entire keyboard) lowers the overall volume level.



At powerup, the piano is set to standard volume balance.

## Changing the Amount of Resonance of the Damper Pedal

On an acoustic piano, depressing the damper pedal makes the notes you play resonate with other strings, adding rich reverberations and thickness to the sound. On the FP-9 as well, when you choose a piano tone, depressing the damper pedal automatically adds this resonance (sympathetic resonance) to the sound. This resonance is added to the six tones in the Piano 1 and Piano 2 Tone Groups.

You can vary the depth (amount) of resonance at this time within an eight-step range.

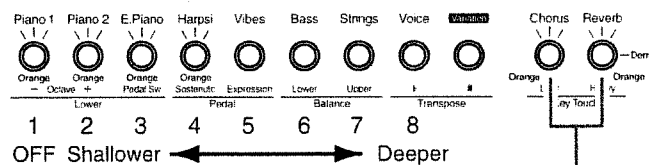

The further toward "Deeper" that the flashing Tone button lights go, the greater the amount of resonance.

holding down

1. Simultaneously holding down the [Chorus] and [Reverb] buttons continuously will show you the currently selected amount of resonance.

The indicator lights for the [Chorus] button, the [Reverb] button, and the Tone buttons each flash in orange.

The number of flashing Tone buttons indicates the amount of resonance.

The relationship between the Tone buttons and the amount of resonance is shown above.

2. Hold down the [Chorus] and [Reverb] buttons and press one of the Tone buttons to select the amount of resonance.

You can also choose the amount of resonance by holding down the [Chorus] and [Reverb] buttons and pressing the [Variation] button.

The next time you choose the same tone, resonance with the depth you've selected here is applied.



The setting is at "4" when the FP-9 is powered up.



During dual or split play, the resonance applied to the lower tone will have the same amount as that set for the upper tone.



If you change the amount of resonance while you have the lower tone selected during split play, the setting is stored in memory for the upper tone.

## Changing How the Pedals Work

When you connect a pedal to the Soft pedal jack, it normally works as a soft pedal (see p. 10). However, you can change it to make it work as a sostenuto pedal or an expression pedal.

For use as a sostenuto pedal, connect the supplied DP-6 pedal. For use as an expression pedal, connect the separately available EV-5 expression pedal.

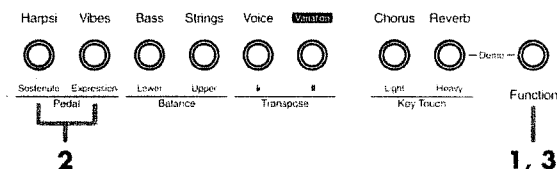

1. Press the <<Function>> button to make the indicator light flash in red.
2. Press the Pedal <<Sostenuto>> or <<Expression>> button to change how the pedal works (see the figure at right).
3. Press the <<Function>> button to make the indicator light go dark.



At powerup, the setting is normally made to function as the soft pedal.



Use only the specified expression pedal (EV-5; sold separately). By connecting any other expression pedals, you risk causing malfunction and/or damage to the unit.

### Sostenuto Pedal

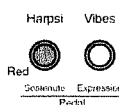

Press the Pedal <<Sostenuto>> button to make the indicator light up in red. You can add lingering reverberations to just the keyboard notes that you finger while you depress the pedal. Connect the supplied pedal (DP-6).

### Expression Pedal

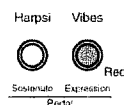

Press the Pedal <<Expression>> button to make the indicator light up in red. You can control the volume level. You can also change the volume with the [Speaker Volume] knob, but by using this pedal you can change the volume level without taking your hands off the keyboard. Connect a separately available expression pedal (EV-5).

### Soft Pedal



Press the Pedal <<Sostenuto>> or <<Expression>> button to make the indicator lights for both buttons go dark. Making the Setting for the Soft Pedal

## Setting Whether to Apply Effects to the Lower Tone

During dual play or split play, depressing a pedal applies its effect to just the upper tone. However, you can make it so that the effect is also applied to the lower tone.

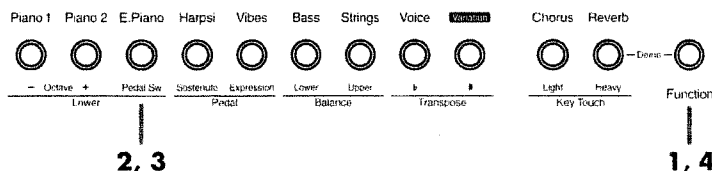

1. Press the <<Function>> button to make the indicator light flash in red.
2. Press the Lower <<Pedal Sw>> button to make the button's indicator light up.

Depressing the pedal now applies the effect to the lower tone as well.

3. Pressing the Lower <<Pedal Sw>> again to make the indicator light go dark stops the effect from being applied to the lower tone.
4. Press the <<Function>> button to make the indicator light go dark.



At powerup, the setting is for applying effects only to the upper tone.

## Setting the Pitch of the Lower Tone in Octave Steps—Octave Shift

You can change the pitch of the lower tone an octave at a time during dual play or split play. This function is called “octave shift.” For instance, you can raise the pitch of the lower tone to the same pitch as the upper tone. You can vary the pitch within a range down two octaves or up two octaves.

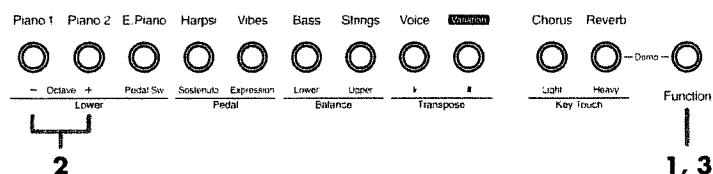

1. Press the <<Function>> button to make the indicator light flash in red.
2. Each press of the Lower <<Octave ->> button lowers the pitch by one octave, and each press of the Lower <<Octave +>> button raises it an octave.

At this time, the indicator light for the Lower <<Octave ->> or <<Octave +>> button lights up in red.

If you make the pitch two octaves lower than the original pitch, the Lower <<Octave ->> button’s indicator light flashes red.

If you make the pitch two octaves higher than the original pitch, the Lower <<Octave +>> button’s indicator light flashes red.

If you want to go back to the original pitch, press the Lower <<Octave ->> and <<Octave +>> buttons at the same time to make the indicator lights for both buttons go dark.

3. Press the <<Function>> button to make the indicator light go dark.



The setting remains in effect until you turn off the power.

## Adjusting the Pitch to Match Another Instrument—Tuning

You can adjust the pitch to match other instruments for ensemble play and the like. When the Tune knob indicator is centered, the pitch of middle A is 440.0 Hz.

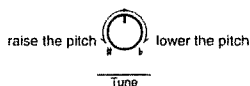

1. Turn the Tune knob toward “#” to raise the pitch.
2. Turn the Tune knob toward “b” to lower the pitch.



Positioning the knob’s center detent at “#” or “b” respectively raises or lowers the pitch by 50 cents (1/2 semitone).

# CONNECTING WITH AUDIO EQUIPMENT OR OTHER ELECTRONIC MUSICAL INSTRUMENTS

The FP-9 has high-quality built-in stereo speakers that let you easily enjoy performing, but you can also hook up a stereo system, and enjoy performances that are even more impressive. You can also record what you play on a tape recorder or the like. Before you connect any external equipment, be sure that the power to the FP-9 is off.

## Playing Audio Equipment or Other Digital Instruments Through the FP-9's Speakers—The Line In Jacks and Line In Level Knob

If you want to play along on the keyboard with the sound from an audio device such as a CD player or an electronic instrument like a rhythm machine, then connect the L and R Line In jacks to the corresponding L and R Output (or Line Out) jacks on the external device.

You can also hook up a device with no built-in speakers (such as a microphone or a guitar), and hear it through the FP-9's speakers.

### Making the Connections

If you're using the Line In jacks to connect an external device, follow the steps below to make the connections. If this is not done in the correct sequence, you risk causing malfunction and/or damage to speakers on the FP-9 or the connected device.

1. Turn the volume all the way down on the FP-9 and on the device you're about to connect.
2. Set the Line In Level control on the back of the FP-9 to Line.
3. Switch off the power to the FP-9 and the device you're about to connect.
4. Use a connecting cable (such as the PJ-1M, sold separately) to make the connection.
5. Switch on the connected device.
6. Switch on the FP-9.

### Example: Let's connect a synthesizer.

What you need: Two "1/4" phone to 1/4" phone " connecting cables (such as the PJ-1M, sold separately)

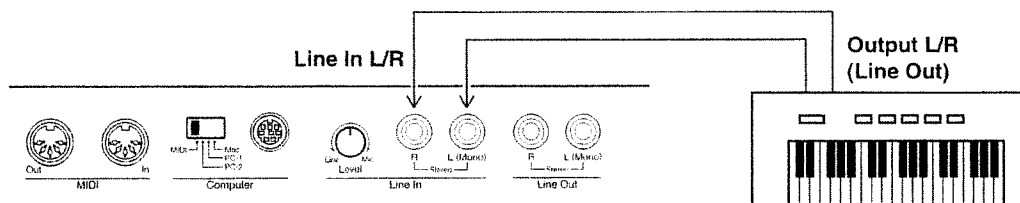

1. Make the connections as illustrated above.
3. Use the [Speaker Volume] knob on the front panel to adjust the volume level from the FP-9's speakers.

Follow the steps in "Making the Connections" to hook up the devices.

2. Use the Line In Level knob on the back of the FP-9 to adjust the level (volume) of input from the connected device.

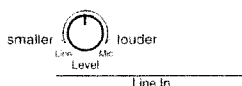

### NOTE

If the external equipment is a monaural-output device, be sure to connect to the L (Mono) Line In jack on the FP-9.

---

## Playing Sounds from the FP-9 on an Audio Device or Using an Audio Device to Record What You Play—The Line Out Jacks and Line Out Volume Knob

---

If you want to play the sound of the FP-9 on an audio device or record what you play on a tape recorder, then connect the L and R Line Out jacks to the corresponding L and R Input (or Line In or AUX IN) jacks on the external device.

### Making the Connections

If you're using the Line Out jacks to connect an external device, follow the steps below to make the connections. If this is not done in the correct sequence, you risk causing malfunction and/or damage to speakers on the FP-9 or the connected device.

1. Turn the volume all the way down on the FP-9 and on the device you're about to connect.
2. Switch off the power to the FP-9 and the device you're about to connect.
3. Use a connecting cable (such as the PJ-1M, sold separately) to make the connection.
4. Switch on the FP-9.
5. Switch on the connected device.

### Example: Let's connect the FP-9 to a stereo system.

What you need: Two "RCA phono to 1/4" phone" connecting cables (such as the PJ-1M, sold separately)

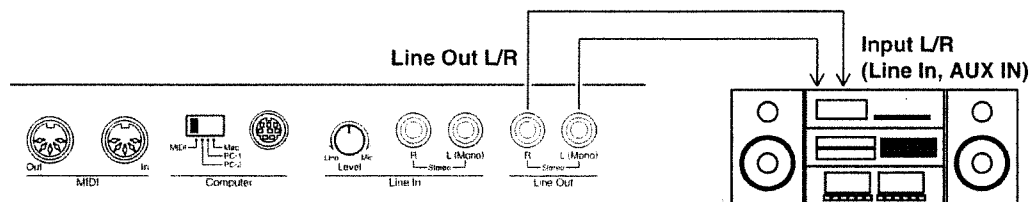

1. Make the connections as illustrated above.  
Follow the steps in "Making the Connections" to hook up the devices.
2. Use the [Line Out Volume] knob on the front panel to adjust the level (volume) of output to the connected device.
3. Adjust the volume of the connected device.

**NOTE**

If the connected equipment is a monaural-input device, be sure to connect to the L (Mono) Line Out jack on the FP-9.

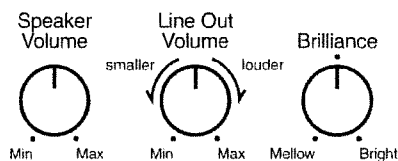

# IF YOU'RE CONNECTING THE FP-9 TO A MIDI INSTRUMENT

## What's MIDI?

MIDI stands for "Musical Instrument Digital Interface," and is a unified worldwide standard for the exchange of performance data (MIDI message) and other information between electronic instruments and computers.

The FP-9 is equipped with MIDI connectors and a Computer jack to let it exchange performance information with external devices. These jacks can be used to connect the FP-9 to an external device for even greater versatility.

\* A separate publication titled "MIDI Implementation" is also available. It provides complete details concerning the way MIDI has been implemented on this unit. If you should require this publication (such as when you intend to carry out byte-level programming), please contact the nearest Roland Service Center or authorized Roland distributor.

## About MIDI Connectors

The FP-9 has two types of MIDI connectors. Connecting these to the MIDI connectors on a MIDI instrument makes it possible for the two instruments to control each other. For instance, you can output sound from the other instrument or switch tones on the other instrument.

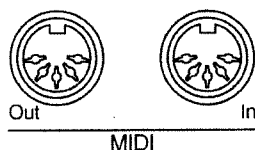

### •MIDI OUT Connector

Performance messages such as information on what keys are played are sent to an external MIDI device from here.

### •MIDI IN Connector

Performance messages from an external MIDI device are received here. These incoming messages may instruct the receiving MIDI instrument to play sounds or switch tones.

## How to Enjoy MIDI and the Steps for Making Connections

### How to Enjoy MIDI

Some of the many ways you can have fun using MIDI are described below.

#### Using a sequencer (\*1) to record performance data played on the FP-9, or automatically playing recorded performance data

Connection example: Connecting to a sequencer (the Roland MT series)

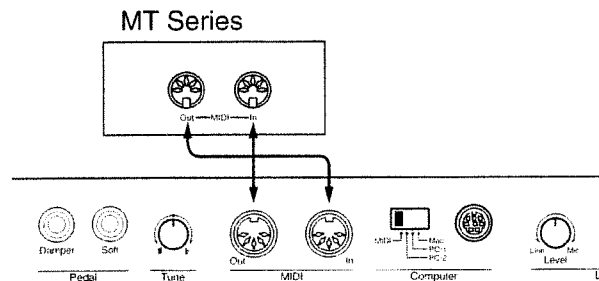

When connecting a sequencer, we recommend using it with the settings described below.

-Local Control off (see p. 26)

-MIDI mode 1 (see p. 29)

The MIDI mode is set to "1" at powerup.

(\*1) This is a device that takes what's played on an instrument and converts it to MIDI messages that describe the timing, the note, the velocity, and the length of what is played. You can achieve automatic play by sending recorded MIDI information to the instrument.

Since you can control a number of instruments at the same time, orchestral performances with MIDI instruments are also possible.

#### Fingering the FP-9 and Playing the Sound on Another MIDI Sound Module (\*2)

Connection example: Connecting to a MIDI sound module

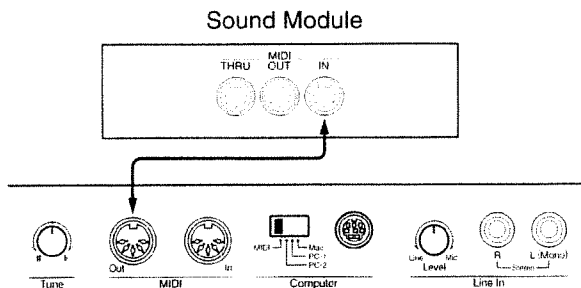

When connecting to a MIDI sound module, we recommend use with the MIDI mode set to "2" (see p. 29).

The MIDI mode is set to "1" at powerup.

You can also modify or edit MIDI messages as you please.

(\*2) A sound module is a device with an independent sound generator, similar to a MIDI keyboard such as a synthesizer or a digital piano with the keyboard portion detached. The sound module uses MIDI messages from other instruments to generate sounds.



## Making the Connections

When connecting the FP-9 to an external MIDI instrument, be sure to follow the steps below to make the connections. If you make a mistake in the procedure, the FP-9 or the connected device may not operate correctly.

1. Switch off the power to the FP-9 and the device you're about to connect.  
At this time, turn the volume all the way down on each of the devices.
2. Set the Computer switch on the back of the unit to "MIDI."  
Change the setting of the Computer switch only while the power to the unit is off. Operation may not be correct if the setting is changed while the power is on.
3. Use a MIDI cable (the Roland MSC series or the like, sold separately) to connect the MIDI connector on the external instrument to the MIDI connector on the FP-9.
4. Switch on the power to the FP-9 and the connected device.
5. Adjust the volume level on the FP-9 and the connected device.
6. You should also set the MIDI channel (see p. 25) and switch Local Control on or off as needed (see p. 26).

## Setting the Channels for Exchanging MIDI Messages

MIDI has something called "channels," which are numbered from 1 to 16. If you hook up two devices with a MIDI cable, you won't be able to exchange MIDI messages unless both devices are set to the same MIDI channel.

Make the setting for the MIDI channel on which the FP-9 sends MIDI information and receives MIDI information from external instruments.

During dual play or split play, the upper tone and the lower tone have separate MIDI channels. The setting you make here is only the MIDI channel for the upper tone. The MIDI channel for the lower tone is automatically set to the channel number that is one higher than the upper-tone MIDI channel.

On the FP-9, the send channel and the receive channel are the same.

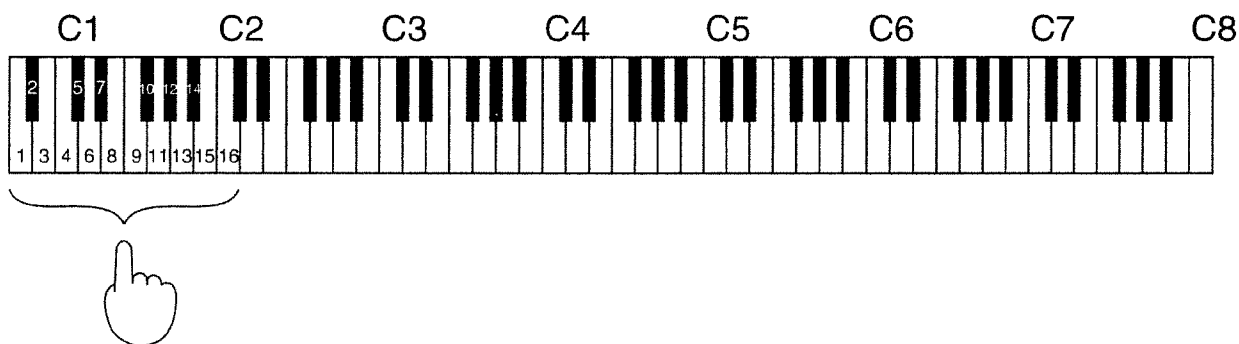

1. Hold down the <<Function>> button and press one of the keys in the range shown above to choose the channel for sending and receiving.
2. Press the <<Function>> button to make the indicator light go dark.

While you hold down the <<Function>> button, the button's indicator lights up in red.

Upper Tone and Lower Tone MIDI Channel Correspondences

Upper Tone	1	2	3	4	5	6	7	8	9	10	11	12	13	14	15	16
Lower Tone	2	3	4	5	6	7	8	9	10	11	12	13	14	15	16	1

## Switching Local Control On and Off

The switch that toggles Local Control on or off determines whether or not the FP-9's keyboard section is connected with the internal sound generating section.

You can connect the FP-9 and a sequencer, record a keyboard performance on the sequencer, then play back the performance with the sequencer.

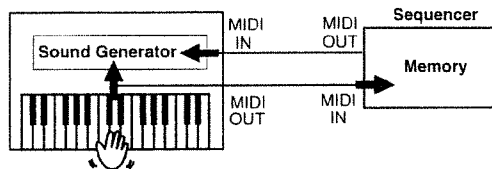

If the sequencer's THRU function is on at this time, the same notes are sounded twice. Performance information from the keyboard reaches the sound generator by two routes, (1) and (2), so the played notes may sound strange, or the number of notes sounded at the same time may decrease. To prevent this, what's known as "Local Control" is set to "off" to isolate route (1).

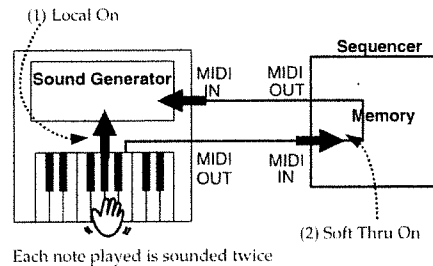

**Local Control on:** The keyboard and the internal sound generator are in a linked state.

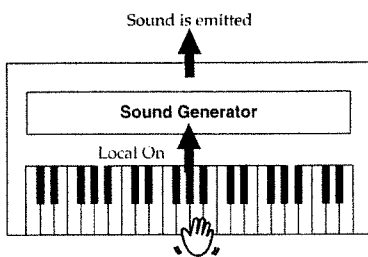

**Local Control off:** The keyboard and the internal sound generator are in an unlinked state.

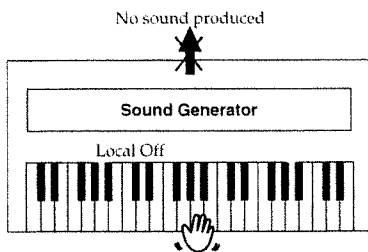

1. Press the <<Function>> button to make the indicator light flash in red.

To cancel this operation, press the <<Function>> button again to make the indicator light go dark.

2. Press the <<Local>> button to make the setting (on or off).

When the <<Local>> button's indicator lights up in red, Local Control is on.

When you finger the keyboard, the FP-9 produces sound. When the <<Local>> button's indicator light is dark, Local Control is off.

When you finger the keyboard, the FP-9 does not produce sound.

3. Press the <<Function>> button to make the indicator light go dark.



The setting is at "Local Control on" at powerup.



The setting for Local Control is also switched on and off by MIDI Local Control messages that are received. When connecting a member of the Roland MT series, the MT-series instrument sends Local Control off information when it is switched on. When you switch on first the FP-9 then the MT-series instrument, the FP-9 automatically turns off Local Control.

# Sending Tone Change Information—Sending Program Change and Bank Select MSB or LSB Messages

## Sending Program Change Messages

With a MIDI instrument, each tone is assigned a number from 1 to 128 called a Program Number, and a three-digit number that is a combination of Group/Bank/Number. A Program Change message is MIDI information for switching tones that uses either this Program Number or this Group/Bank/Number to issue an instruction on the number to switch to.

You can change tones on an external MIDI instrument by sending a Program Change message.

The setting is at “1” when the FP-9 is powered up.



The tones that correspond to the Program Change numbers may differ according to the connected instrument. Verify the Program Change numbers for the connected instrument.

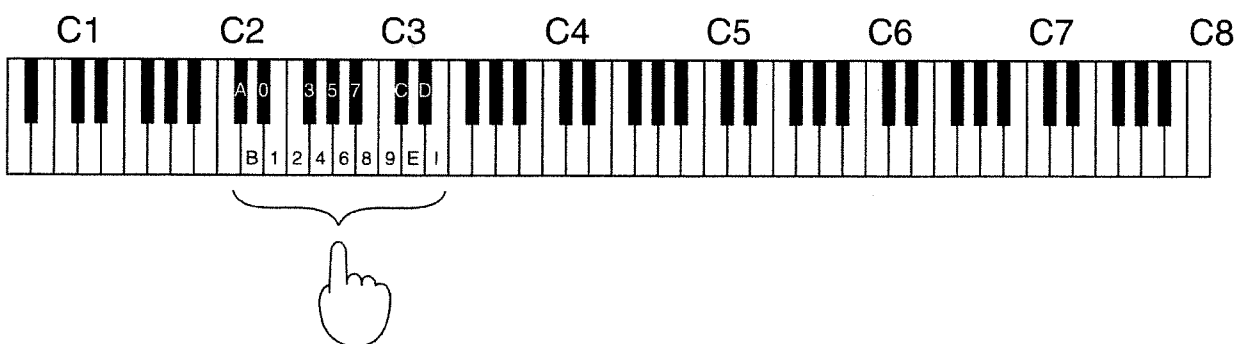

1. Hold down the <<Function>> button and press one of the keys in the range shown above to choose the Program Change number to send.

### When Sending with a Program Number

2. Press, in sequence, the keys (0 through 9) that correspond to the number (1 through 128) you want to send.

If you press the wrong key, press the C (Clear) key shown in the figure. This cancels the keys (for Program Change only) that you have pressed so far.

3. Press the E (Enter) key in the figure to send the Program Change message.

Press the I (Inc, or “increment”) key in the figure to send a number that is one higher than the selected number.

Press the D (Dec, or “decrement”) key in the figure to send a number that is one lower than the selected number.

4. Press the <<Function>> button to make the indicator light go dark.

### When Sending with Group/Bank/Number

At step **2** of the procedure shown at left, press, in sequence, the keys that correspond to the Group (A/B), Bank (1 through 8), and Number (1 through 8). The Program Change message is sent when you press the third key. You don’t need to press the E (Enter) key shown in the figure.



Program Numbers correspond to Group/Bank/Number as shown below.

Program Number	001	002	-	064	-	065	-	128
Group/Bank/Number	A11	A12	-	A88	-	B11	-	B88

---

## Sending Bank Select MSB and LSB Messages

You can choose up to 128 types of tones from a connected MIDI sound device by using Program Change messages. With a MIDI sound device that has more than 128 on-board tones, however, you need to send MIDI information called a “Bank Select message” to specify the Tone Bank, then use a Program Change message to specify the number of the tone within the Bank. Using Bank Select and Program Change messages, you can choose from and switch to a larger number of tones.

Bank Select messages are of two types: MSB and LSB.

The settings for MSB and LSB are both at “0” when the FP-9 is powered up.

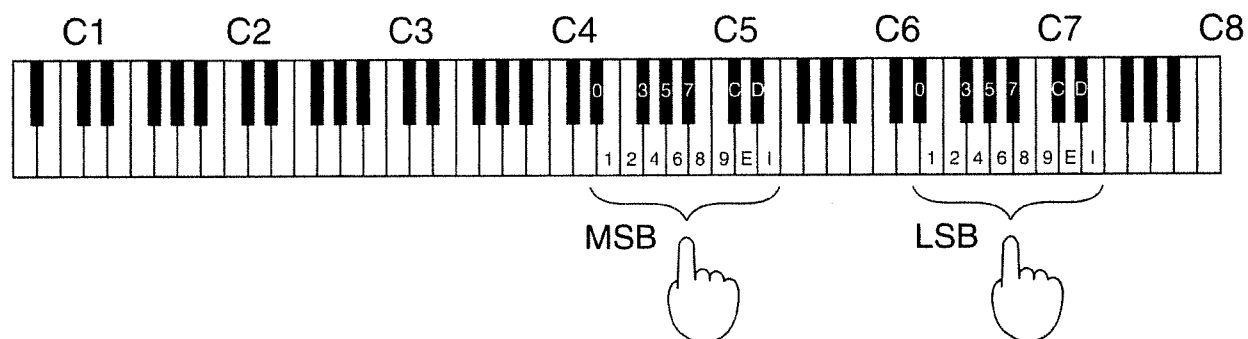

1. Hold down the <<Function>> button and press, in proper sequence, the keys (0 through 9) that correspond to the numbers (0 through 127) for the Bank Select MSB and LSB messages you want to send.
2. If you press the wrong key, press the C (Clear) key shown in the figure.  
This cancels the keys (for Bank Select MSB only or LSB only) that you have pressed so far.
3. Press the E (Enter) key in the figure to send the Bank Select message.  
Press the I (Inc, or “increment”) key in the figure to send a number that is one higher than the selected number.  
Press the D (Dec, or “decrement”) key in the figure to send a number that is one lower than the selected number.
4. Press the <<Function>> button to make the indicator light go dark.

## Setting the MIDI Mode

When switching tones on the FP-9, you can switch what is in the MIDI information being output from the MIDI Out connector to a setting that is suited to the connected MIDI instrument. You can choose either of two types of settings. These settings are called "MIDI modes."

The setting is at "MIDI mode 1" when you turn on the power.

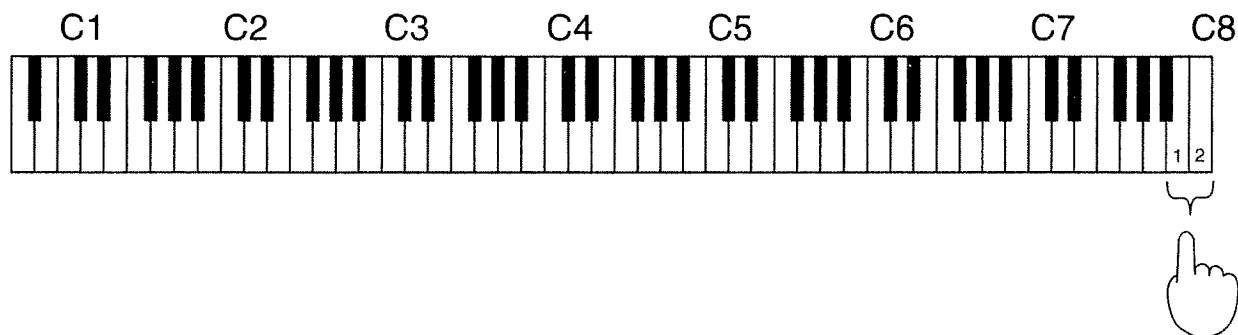

1. Hold down the <<Function>> button and press either the "1" or "2" key shown above to select the MIDI mode.

While you hold down the <<Function>> button, the button's indicator flashes in red.

2. Press the <<Function>> button to make the indicator light go dark.

Key	MIDI mode	
1	MIDI mode 1	<p>This mode is suited to a connection with a sequencer. The MIDI information shown below is output from the MIDI Out connector when you switch tones on the FP-9. If you're recorded something on a sequencer, this procedure lets you play back the performance on the FP-9 with the same tones as when you recorded the performance.</p> <ul style="list-style-type: none"> <li>• Program Change messages</li> <li>• Whether to apply reverb and chorus effects</li> <li>• Depth of reverb and chorus effects</li> </ul>
2	MIDI mode 2	<p>This mode is suited to a connection with a sound module. The MIDI information shown below is output from the MIDI Out connector when you switch tones on the FP-9. If you've connected an external sound module, you can switch just the sound-module tones.</p> <ul style="list-style-type: none"> <li>• Program Change messages</li> </ul>



Pressing a Tone button selects the corresponding sound on the FP-9 and also transmits the appropriate Program Change Number (see the table at right) through the MIDI Out connector on the rear panel of the FP-9.

### Program Change Numbers

PC# — Program Change number

Tone Group	Tone	PC#
Piano 1	Full Grand 1	001
	Full Grand 2	002
	Honky-Tonk	003
Piano 2	Pop Piano	004
	Classic Piano	005
	Rock Piano	006
E.Piano	Stage Rhodes	007
	SA Rhodes	008
	FM E.Piano	009
Harpsi	Harpsichord	010
	Clav 1	011
Vibes	Clav 2	012
	Vibraphone	013
	Marimba	014
Bass	Glockenspiel	015
	Ac.Bass	016
	Finger Bass	017
Strings	Voice Bass	018
	Orch.Strings	019
	Synth Strings 1	020
Voice	Synth Strings 2	021
	Jazz Scat	022
	Choir 1	023
	Choir 2	024

# IF YOU'RE CONNECTING A COMPUTER

## How to Enjoy and the Steps for Making Connections

---

### How to Enjoy

Read on to find out how you can hook up the FP-9 to a computer and enjoy it.

**Using sequencer software (such as Roland Visual-MT) instead of a sequencer (see p. 24) to record performance data you play on the FP-9 or automatically play recorded performance data on the FP-9**



When using a sound device connected to a computer that is running Windows-based applications (such as sequencer software), you need to install a serial MIDI driver on the computer. Sound will not play if there is no serial MIDI driver. If you do not have a serial MIDI driver, you can download one from the Roland web site shown below.

For information on how to install it, refer to the documentation for your computer and software.

Go to <http://www.rolandcorp.com>, scroll down to Downloads, and click Driver Software for Windows.

### Making the Connections

When connecting the FP-9 to a computer, be sure to follow the steps below to make the connections. If you make a mistake in the procedure, the FP-9 or the connected computer may not operate correctly.

1. Turn off the FP-9 and the computer.

At this time, turn the volume all the way down on each of the devices.

2. Use a computer cable to connect the Computer connector on the back of the unit to the computer's serial port.

Be sure to use the correct computer cable for the type of computer you're connecting. Take a look at the examples of connections described on the next page.

3. Set the Computer switch on the back of the unit to match the type of computer you're connecting.

Take a look at the examples of connections described on the next page.

\* *Change the setting of the Computer switch only while the power to the unit is off. Operation may not be correct if the setting is changed while the power is on.*

4. Turn on the FP-9 and the computer.

5. Adjust the volume level for each device.

6. Make the settings for baud rate (transmission speed) for the computer and the software.

For more information, refer to the documentation for the computer you're using.

7. You should also set the MIDI channel (see p. 25) and switch Local Control on or off as needed (see p. 26).

---

## Connection examples:

### Connection with an Apple Macintosh Computer

Use a computer cable (designed for the Apple Macintosh series) to connect the Computer connector on the FP-9 to the modem port (or printer port) on the Apple Macintosh. Set the Computer switch to "Mac."

Alternatively, if you're using Patch Bay on the Macintosh, set Interface Type (MIDI Interface Clock) to 1 MHz.

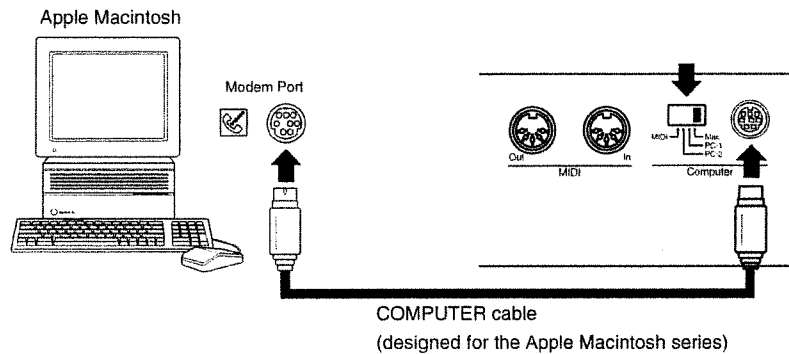

### Connection with an IBM PC/AT Series Computer

Use a computer cable (designed for IBM PC/ATs and compatibles) to connect the Computer connector on the FP-9 to the COM1 or COM2 ports on the IBM PC/AT computer. Set the Computer switch to "PC-2."

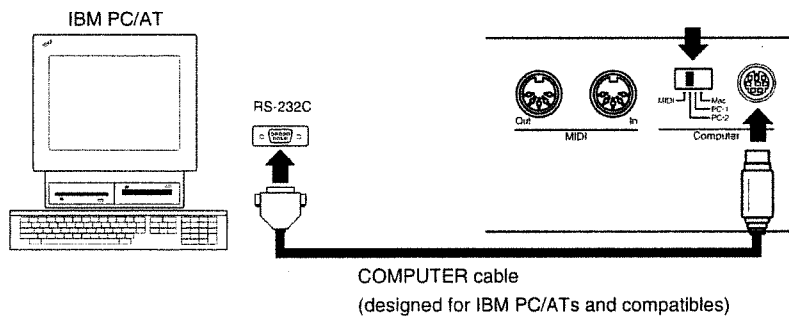

# APPENDICES

## Trouble Shooting

### If you think there's a problem, read this first.

#### The Power Doesn't Come On

- Is the power cord connected and plugged in correctly? (p. 11)

#### There's No Sound

- Is the [Speaker Volume] knob set at "Min" (minimum)? (p. 11)
- Are headphones plugged in? (p. 10)
- Has the volume level been lowered using the expression pedal?
- Is the DP-6 (the supplied pedal) connected to the Soft pedal jack, and set to be used as the expression pedal?

You can't use the DP-6 as an expression pedal. Change it to function as the soft pedal or the sostenuto pedal (p. 20).

- Has Local Control been set to "off"?

Set Local Control to "on" (p. 26).

#### There's No Sound (when connected to an audio device or another digital instrument)

When inputting the sound from a connected device to the FP-9's speakers (such as when playing the sound of a connected device through the speakers on the FP-9)

- Is the volume level on the connected device turned down too far?

Use the Line In Level knob on the back of the FP-9 to adjust the level (volume) of input from the connected device (p. 22).

When outputting the sound from the FP-9 to a connected device (such as when playing the sound from the FP-9 on a connected device)

- Is the [Line Out Volume] knob on the front panel set to "Min"?

Turn the [Line Out Volume] knob toward Max to adjust the level (volume) of output to the connected device (p. 23).

#### There's No Sound (when connected to a MIDI instrument or a computer)

- Have all devices been switched on? (p. 25 and p. 30)
- Are cables connected correctly? (p. 25 and p. 30)
- Has the Computer switch on the back of the unit been set correctly?

Set the Computer switch to match the type of connected computer (p. 25 and p. 31).

- Does the MIDI channel match the connected instrument? (p. 25)

#### The Volume Is Too Low

- Have the volume balance for the upper and lower tones been changed?

If you've raised the volume level of the lower tone, returning to normal play (that is, playing with a single tone for the entire keyboard) lowers the overall volume level. If you want to go back to the original volume level, press the <<Function>> button to make the indicator light flash in red, then press the Balance <<Upper>> and <<Lower>> buttons at the same time to make the indicator lights for both buttons go dark (p. 19).

#### Sounds Are Heard Twice (Doubled) When the Keyboard Is Played

- Is dual play enabled?

Press either one of the Tone buttons to cancel dual play (p. 14).

- When connecting an external sequencer, set Local Control on the FP-9 to "off" (p. 26).

Alternatively, set SOFT THRU on the sequencer to "off."

#### The Key or Pitch of Played Notes Is Off

- Has the pitch been transposed?

If you want to go back to the original key, press the <<Function>> button to make the indicator light flash in red, then press the <<Transpose  $\sharp$ >> and <<Transpose  $\flat$ >> buttons at the same time to make the indicator lights for both buttons go dark (p. 18).

- Is the indicator for the Tune knob set to " $\sharp$ " or " $\flat$ "?

Position the knob so it points at the center (p. 21).

- Has the pitch of the lower tone been changed with Octave Shift? (p. 21)

If you want to go back to the original pitch, press the <<Function>> button to make the indicator light flash in red, then press the Lower <<Octave ->> and <<Octave +>> buttons at the same time to make the indicator lights for both buttons go dark.

#### The Pedal Doesn't Work

- Is the pedal connected correctly? (p. 10)
- Has the way the pedal works been changed? (p. 20)
- Has another type of pedal been connected?

For use as a damper pedal, soft pedal, or sostenuto pedal, connect the supplied pedal (the DP-6). For use as an expression pedal, connect the EV-5 expression pedal sold separately (p. 10 and p. 20).

#### The Pedal Effect Doesn't Stop

- Unplugging a pedal cord from the unit while the power is on may cause the pedal's effect to be applied without stopping.

Be sure to switch off the power to the unit before attempting to disconnect or connect a pedal cord (p. 10).



# MIDI Implementation Chart

Function...		Transmitted	Recognized	Remarks
Basic Channel	Default Changed	1 1 - 16	1 1 - 16	
Mode	Default Messages Altered	Mode 3 x *****	Mode 3 x	
Note Number :	True Voice	0 - 127 *****	0 - 127 0 - 127	
Velocity	Note ON Note OFF	O x (8n, v=64)	O x	
After Touch	Key's Ch's	x x	x x	
Pitch Bend		x	x	
Control Change	0, 32	O	x	Bank Select
	6, 38	O	O	Data entry
	7	O	O	Volume
	11	O	O	Expression
	64	O	O	Hold 1
	66	O	O	Sostenuto
	67	O	O	Soft
	91	O	O	Effect 1 Depth (Reverb)
93	O	O	Effect 3 Depth (Chorus)	
100, 101	O	O	RPN LSB, MSB	
Prog Change	: True #	O (0 - 127) *****	O (0 - 127) 0 - 23	
System Exclusive		O	O	
System Common	SongPos SongSel Tune	x x x	x x x	
System Real Time	Clock Commands	x x	x x	
Aux Message	All Sound OFF Reset All Controllers Local ON/OFF All Notes OFF Active Sense Reset	x x x x O x	x O O O (123 - 127) O x	
Notes				

Mode 1 : OMNI ON, POLY

Mode 2 : OMNI ON, MONO

O : Yes

Mode 3 : OMNI OFF, POLY

Mode 4 : OMNI OFF, MONO

x : No

---

## Specifications

---

### FP-9: Digital Piano

- **Keyboard**  
88 keys (hammer action mechanism, with velocity)
  - **Touch Control**  
Light, Medium or Heavy
  - **Maximum Polyphony**  
64 voices
  - **Tones**  
8 groups 24 variations
  - **Effects**  
Reverb (8 types)  
Chorus (8 types)  
Sympathetic Resonance
  - **Controls**  
Speaker Volume Knob  
Line Out Volume Knob  
Brilliance Knob  
Line In Level Knob  
Tune Knob  
Computer Switch
  - **Master Tuning**  
+/-50 cents
  - **Connectors**  
Line Out Jacks (Mono/Stereo)  
Line In Jacks (Mono/Stereo)  
Headphones Jack  
Pedal Jacks (Damper, Soft/Sostenuto/Expression)  
MIDI Connectors (In/Out)  
Computer Connector
  - **Speakers**  
10 cm x 2, 5 cm x 2
  - **Rated Power Output**  
10 W x 2
  - **Power Supply**  
AC 117 V / AC 230 V / AC 240 V
  - **Power Consumption**  
30 W (AC 117 V / AC 230 V / AC 240 V)
  - **Dimensions (Without the music stand)**  
Piano (FP-9) :  
1321 (W) x 390 (D) x 117 (H) mm  
52-1/16 (W) x 15-3/8 (D) x 4-5/8 (H) inches  
Stand (FPS-9) :  
1258 (W) x 390 (D) x 639 (H) mm  
49-9/16 (W) x 15-3/8 (D) x 25-3/16 (H) inches  
Total:  
1321 (W) x 390 (D) x 756 (H) mm  
52-1/16 (W) x 15-3/8 (D) x 29-13/16 (H) inches  
*\* FPS-9: sold separately*
  - **Weight (Without the music stand)**  
Piano (FP-9) : 26.1 kg / 57 lbs 9 oz  
Stand (FPS-9) : 9.1 kg / 20 lbs 1 oz  
Total: 35.2 kg / 77 lbs 10 oz  
*\* FPS-9: sold separately*
  - **Accessories**  
Owner's Manual  
Power Cord  
Music Stand  
Pedal Switch (DP-6)  
Piano Cover
  - **Options**  
Stand (FPS-9)  
Pedal Switch (DP-6)  
Expression Pedal (EV-5)
- \* In the interest of product improvement, the specifications and/or appearance of this unit are subject to change without prior notice*

---

# Index

---

## [B]

Balance	19
Bank Select MSB/LSB	28
Brilliance	11

## [C]

Chorus Effect	16
---------------	----

## [D]

Damper Pedal	10
Demo Play	12
Dual Play	14

## [E]

Expression Pedal	10, 20
------------------	--------

## [F]

Front Panel	8
Function	9

## [K]

Key Touch	18
Key Transpose	18

## [L]

Line In Level Knob	7, 22
Line Out Volume Knob	8, 23
Local Control On/Off	26
Lower Tone	14, 15, 20, 21

## [M]

MIDI	24
MIDI Connector	24
MIDI Channel	25
MIDI Mode	29

## [O]

Octave Shift	21
--------------	----

## [P]

Pedal	10, 20
Pedal Sw	20
Phones Jack	10
Program Change Message	27

## [R]

Rear Panel	7
Reverb Effect	17

## [S]

Sequencer	24
Soft Pedal	10
Sostenuto Pedal	10, 20
Sound Module	24
Split Play	14
Split Point	14, 15
Sympathetic Resonance	19

## [T]

Tone Group	13
Transpose	18
Tuning	21

## [U]

Upper Tone	14, 15
------------	--------

## [V]

Volume	
Speaker Volume	8, 11
Line In Level (Volume)	7, 22
Line Out Volume	8, 23

## Information

When you need repair service, call your nearest Roland Service Center or authorized Roland distributor in your country as shown below.

### ARGENTINA

**Instrumentos Musicales S.A.**  
Florida 656 2nd Floor  
Office Number 206A  
Buenos Aires  
ARGENTINA, CP1005  
TEL: (54-1) 394-6057

### BRAZIL

**Roland Brasil Ltda.**  
R. Coronel Octaviano da Silveira  
203 05522-010  
Sao Paulo BRAZIL  
TEL: (011) 843 9377

### CANADA

**Roland Canada Music Ltd.**  
(Head Office)  
5480 Parkwood Way Richmond  
B. C., V6V 2M4 CANADA  
TEL: (0604) 270 6626

**Roland Canada Music Ltd.**  
(Toronto Office)  
Unit 2, 109 Woodbine Downs  
Blvd, Etobicoke, ON  
M9W 6Y1 CANADA  
TEL: (0416) 213 9707

### MEXICO

**Casa Veerkamp, s.a. de c.v.**  
Av. Toluca No. 323 Col. Olivar de  
los Padres 01780 Mexico D.F.  
MEXICO  
TEL: (525) 668 04 80

**La Casa Wagner de  
Guadalajara s.a. de c.v.**  
Av. Corona No. 202 S.J.  
Guadalajara, Jalisco Mexico  
C.P. 41100 MEXICO  
TEL: (03) 613 1414

### PANAMA

**Productos Superiores, S.A.**  
Apartado 655 - Panama 1  
REP. DE PANAMA  
TEL: (507) 270-2200

### U. S. A.

**Roland Corporation U.S.**  
7200 Dominion Circle  
Los Angeles, CA. 90040-3696,  
U. S. A.  
TEL: (0213) 685 5141

### VENEZUELA

**Musiland Digital C.A.**  
Av. Francisco de Miranda,  
Centro Parque de Cristal, Nivel  
C2 Local 20 Caracas  
VENEZUELA  
TEL: (02) 285 9218

### AUSTRALIA

**Roland Corporation  
Australia Pty. Ltd.**  
38 Campbell Avenue  
Dee Why West, NSW 2099  
AUSTRALIA  
TEL: (02) 9982 8266

### NEW ZEALAND

**Roland Corporation (NZ) Ltd.**  
97 Mt. Eden Road, Mt. Eden,  
Auckland 3, NEW ZEALAND  
TEL: (09) 3098 715

### CHINA

**Beijing Xinghai Musical  
Instruments Co., Ltd.**  
6 Huangmuyang Chao Yang  
District, Beijing, CHINA  
TEL: (010) 6774 7491

### HONG KONG

**Tom Lee Music Co., Ltd.**  
Service Division  
22-32 Pun Shan Street, Tsuen  
Wan, New Territories,  
HONG KONG  
TEL: 2415 0911

### INDIA

**Rivera Digitech (India) Pvt. Ltd.**  
409, Nirman Kendra,  
off Dr. Edwin Moses Road,  
Mumbai 400011, INDIA  
TEL: (022) 498 3079

### INDONESIA

**PT Galestra Inti**  
Kompleks Perkantoran  
Duta Merlin Blok E No.6-7  
Jl. Gajah Mada No.3-5,  
Jakarta 10130,  
INDONESIA  
TEL: (021) 6335416

### KOREA

**Cosmos Corporation  
Service Station**  
261 2nd Floor Nak-Won Arcade  
Jong-Ro ku, Seoul, KOREA  
TEL: (02) 742 8844

### MALAYSIA

**Bentley Music SDN BHD**  
140 & 142, Jalan Bukit Bintang  
55100 Kuala Lumpur, MALAYSIA  
TEL: (03) 2443333

### PHILIPPINES

**G.A. Yupangco & Co. Inc.**  
339 Gil J. Puyat Avenue  
Makati, Metro Manila 1200,  
PHILIPPINES  
TEL: (02) 899 9801

### SINGAPORE

**Swee Lee Company**  
150 Sims Drive,  
Singapore 387381  
TEL: 784-1669

### CRISTOFORI MUSIC PTE LTD

Blk 3014, Bedok Industrial Park E,  
#02-2148, SINGAPORE 489980  
TEL: 243 9555

### TAIWAN

**ROLAND TAIWAN  
ENTERPRISE CO., LTD.**  
Room 5, 9th. No. 112 Chung Shan  
N.Road Sec.2, Taipei, TAIWAN,  
R.O.C.  
TEL: (02) 2561 3339

### THAILAND

**Theera Music Co., Ltd.**  
330 Veeng Nakorn Kasem, Soi 2,  
Bangkok 10100, THAILAND  
TEL: (02) 2248821

### VIETNAM

**Saigon Music Distributor  
(Tan Dinh Music)**  
306 Hai Ba Trung, District 1  
Ho Chi minh City  
VIETNAM  
TEL: (8) 829-9372

### BAHRAIN

**Moon Stores**  
Bab Al Bahrain Road,  
P.O.Box 20077  
State of BAHRAIN  
TEL: 211 005

### ISRAEL

**Haliilit P. Greenspoon &  
Sons Ltd.**  
8 Retzif Fa'aliya Hashnya St.  
Tel-Aviv-Yahio ISRAEL  
TEL: (03) 682366

### JORDAN

**AMMAN Trading Agency**  
Prince Mohammed St. P. O. Box  
825 Amman 11118 JORDAN  
TEL: (06) 4641200

### KUWAIT

**Easa Husein Al-Yousifi**  
P.O. Box 126 Safat 13002  
KUWAIT  
TEL: 5719499

### LEBANON

**A. Chahine & Fils**  
P.O. Box 16-5857 Gergi Zeidan St.  
Chahine Building, Achrafieh  
Beirut, LEBANON  
TEL: (01) 335799

### OMAN

**OHI Electronics & Trading  
Co. LLC**  
P. O. Box 889 Muscat  
Sultanate of OMAN  
TEL: 959085

### QATAR

**Badie Studio & Stores**  
P.O.Box 62,  
DOHA QATAR  
TEL: 423554

### SAUDI ARABIA

**Abdul Latif S. Al-Ghamdi  
Trading Establishment**  
Middle East Commercial Center  
Al-Khobar Dharan Highway  
P.O. Box 3631 Al-Khobar  
31952 SAUDIARABIA  
TEL: (03) 898 2332

### aDawlah Universal

**Electronics APL**  
P.O.Box 2154 ALKHOBAR 31952,  
SAUDI ARABIA  
TEL: (03) 898 2081

### SYRIA

**Technical Light & Sound  
Center**  
Khaled Ibn Al Walid St.  
P.O.Box 13520  
Damascus - SYRIA  
TEL: (011) 2235 384

### TURKEY

**Barkat Muzik aletleri ithalat  
ve ihracat limited ireketi**  
Siraselvler Cad. Guney Ishani No.  
86/6 Taksim, Istanbul TURKEY  
TEL: (0212) 2499324

### U.A.E

**Zak Electronics & Musical  
Instruments Co.**  
Zabeel Road, Al Sherouq Bldg.,  
No. 14, Grand Floor DUBAI  
U.A.E.  
P.O. Box 8050 DUBAI, U.A.E  
TEL: (04) 360715

### EGYPT

**Al Fanny Trading Office**  
P.O.Box 2904,  
El Horrich Heliopolos, Cairo,  
EGYPT  
TEL: (02) 4171828  
(02) 4185531

### KENYA

**Musik Land Limited**  
P.O. Box 12183 Moi Avenue  
Nairobi Republic of KENYA  
TEL: (2) 338 346

### REUNION

**Maison FO - YAM Marcel**  
25 Rue Jules Merman ZL  
Chaudron - BP79 97491  
Ste Clotilde REUNION  
TEL: 28 29 16

### SOUTH AFRICA

**That Other Music Shop  
(PTY) Ltd.**  
11 Melle Street (Cnr Melle and  
Juta Street)  
Braamfontein 2001  
Republic of SOUTH AFRICA  
TEL: (011) 403 4105

**Paul Bothner (PTY) Ltd.**  
17 Werdmuller Centre Claremont  
7700  
Republic of SOUTH AFRICA  
TEL: (021) 64 4030

### AUSTRIA

**E. Dematte & Co.**  
New-Rum Siemens-Strasse 4  
6063 Innsbruck AUSTRIA  
TEL: (0512) 26 44 260

### BELGIUM/HOLLAND/ LUXEMBOURG

**Roland Benelux N. V.**  
Houtstraat 3 B-2260 Oevel  
(Westerlo) BELGIUM  
TEL: (014) 575811

### BELORUSSIA

**TUSHE**  
U.L. Rabkorovskaya 17  
220001 MINSK  
TEL: (0172) 764-911

### CYPRUS

**Radex Sound Equipment Ltd.**  
17 Diagorou St., P.O.Box 2046,  
Nicosia CYPRUS  
TEL: (02) 453 426

### DENMARK

**Roland Scandinavia A/S**  
Langebrogade 6 Post Box 1937  
DK-1023 Copenhagen K.  
DENMARK  
TEL: 32 95 3111

### FRANCE

**Roland France SA**  
4, Rue Paul Henri SPAAK  
Parc de l'Esplanade F 77 462 St.  
Thibault Lagny Cedex FRANCE  
TEL: 01 600 73 500

### FINLAND

**Roland Scandinavia As,  
Filial Finland**  
Lauttasaarentie 54 B  
Fin-00201 Helsinki, FINLAND  
TEL: (9) 682 4020

### GERMANY

**Roland Elektronische  
Musikinstrumente  
Handelsgesellschaft mbH.**  
Oststrasse 96, 22844 Nordderstedt,  
GERMANY  
TEL: (040) 52 60090

### GREECE

**V. Dimitriadis & Co. Ltd.**  
20, Alexandras St. & Bouboulinas  
54 St. 106 82 Athens, GREECE  
TEL: (01) 8232415

### HUNGARY

**Intermusica Ltd.**  
Warehouse Area "DEPO" Pf.83  
H-2046 Torokbalint, HUNGARY  
TEL: (23) 511011

### IRELAND

**The Dublin Service Centre  
Audio Maintenance Limited**  
11 Brunswick Place Dublin 2  
Republic of IRELAND  
TEL: (01) 677322

### ITALY

**Roland Italy S. p. A.**  
Viale delle Industrie, 8  
20020 Arese Milano, ITALY  
TEL: (02) 937-78300

### NORWAY

**Roland Scandinavia Avd.  
Kontor Norge**  
Lilleakerveien 2 Postboks 95  
Lilleaker N-0216 Oslo  
NORWAY  
TEL: 273 0074

### POLAND

**P. P. H. Brzostowicz Marian**  
UL. Blokowa 32, 03624 Warszawa  
POLAND  
TEL: (022) 679 44 19

### PORTUGAL

**Tecnologias Musica e Audio,  
Roland Portugal, S.A.**  
RUA SANTA CATARINA  
131 - 4000 Porto -PORTUGAL.  
TEL: (02) 208 44 56

### RUSSIA

**Slami Music Company**  
Sadovaya-Triumfal'naya st., 16  
103006 Moscow, RUSSIA  
TEL: 095 209 2193

### SPAIN

**Roland Electronics  
de España, S. A.**  
Calle Bolivia 239 08020 Barcelona,  
SPAIN  
TEL: (93) 308 1000

### SWEDEN

**Roland Scandinavia A/S  
SWEDISH SALES OFFICE**  
Danvik Center 28, 2 tr.  
S-131 30 Nacka SWEDEN  
TEL: (08) 702 0020

### SWITZERLAND

**Roland (Switzerland) AG  
Musitronic AG**  
Gerberstrasse 5, CH-4410 Liestal,  
SWITZERLAND  
TEL: (061) 921 1615

### UKRAINE

**TIC-TAC**  
Mira Str. 19/108  
P.O.Box 180  
295400 Munkachevo, UKRAINE  
TEL: (03131) 414-40

### UNITED KINGDOM

**Roland (U.K.) Ltd.**  
Atlantic Close, Swansea  
Enterprise Park SWANSEA  
West Glamorgan SA7 9FJ,  
UNITED KINGDOM  
TEL: (01792) 700139

## **FP-9 OWNER'S MANUAL CORRECTIONS**

There are some incorrect descriptions in the FP-9 Owner's Manual (the first edition). We apologize for any inconvenience this may cause. Please correct as follows.

- **The 3rd "MEMO" on the right side of page 14.**

- (Wrong) During dual play, depressing a pedal applies its effect only to the upper tone. If you want to apply the effect to the lower tone as well, check out "Setting Whether to Apply Effects to the Lower Tone" (p. 20).

- (Correct) During dual play, depressing a pedal applies its effect both to the upper tone and lower tone. If you don't want to apply the effect to the lower tone, check out "Setting Whether to Apply Effects to the Lower Tone" (p. 20).

- **The 4th "MEMO" on the right side of page 15.**

- (Wrong) Depressing a pedal during split play applies its effect only to the upper tone. If you want to apply the effect to the lower tone as well, check out "Setting Whether to Apply Effects to the Lower Tone" (p. 20).

- (Correct) Depressing a pedal during split play applies its effect both to the upper tone and lower tone. If you don't want to apply the effect to the lower tone, check out "Setting Whether to Apply Effects to the Lower Tone" (p. 20).

- **The line under "Setting Whether to Apply Effects to the Lower Tone" of page 20.**

- (Wrong) During dual play or split play, depressing a pedal applies its effect to just the upper tone. However, you can make it so that the effect is also applied to the lower tone.

- (Correct) During dual play or split play, depressing a pedal applies its effect both to the upper tone and lower tone. However, you can make it so that the effect is applied only to the upper tone.

- **The "MEMO" on the right side of page 20.**

- (Wrong) At powerup, the setting is for applying effects only to the upper tone.

- (Correct) At powerup, the setting is for applying effects both to the upper tone and lower tone.

**Roland Corporation**

D01343423 '98-10-BI2-21D





**Roland®**

---

**71451789**

UPC 71451789

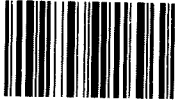

10981

**Roland®**