

Fantom X **AUDIO TRACK EXPANSION**

Guide to the Added Functionality

Before using this unit, carefully read the sections entitled: “USING THE UNIT SAFELY” and “IMPORTANT NOTES” (p. 3; p. 4). These sections provide important information concerning the proper operation of the unit. Additionally, in order to feel assured that you have gained a good grasp of every feature provided by your new unit, this guide should be read in its entirety. This guide should be saved and kept on hand as a convenient reference.

This guide applies to the Fantom-X6, the Fantom-X7, the Fantom-X8 (this guide uses the term “Fantom-X” to indicate all these three models), and FANTOM-X Audio Track Expansion Kit.

Customers who purchased the “FANTOM-X Audio Track Expansion Kit” (update card):

You must first update your Fantom-X. Begin reading from “Check the contents of the package” (p. 8).

Customers who purchased the Fantom-X (synthesizer workstation):



You don't need to update your Fantom-X. Begin reading from “Main features” (p. 12).



Copyright © 2005 ROLAND CORPORATION

All rights reserved. No part of this publication may be reproduced in any form without the written permission of ROLAND CORPORATION.







USING THE UNIT SAFELY

INSTRUCTIONS FOR THE PREVENTION OF FIRE, ELECTRIC SHOCK, OR INJURY TO PERSONS

About  WARNING and  CAUTION Notices





 WARNING	Used for instructions intended to alert the user to the risk of death or severe injury should the unit be used improperly.
 CAUTION	Used for instructions intended to alert the user to the risk of injury or material damage should the unit be used improperly. * Material damage refers to damage or other adverse effects caused with respect to the home and all its furnishings, as well to domestic animals or pets.

About the Symbols





	The  symbol alerts the user to important instructions or warnings. The specific meaning of the symbol is determined by the design contained within the triangle. In the case of the symbol at left, it is used for general cautions, warnings, or alerts to danger.
	The  symbol alerts the user to items that must never be carried out (are forbidden). The specific thing that must not be done is indicated by the design contained within the circle. In the case of the symbol at left, it means that the unit must never be disassembled.
	The  symbol alerts the user to things that must be carried out. The specific thing that must be done is indicated by the design contained within the circle. In the case of the symbol at left, it means that the power-cord plug must be unplugged from the outlet.

ALWAYS OBSERVE THE FOLLOWING

WARNING

- Before using this unit, make sure to read the instructions below, and the Guide to the Added Functionality. 
- Do not open or perform any internal modifications on the unit. 
- Do not attempt to repair the unit, or replace parts within it (except when this guide provides specific instructions directing you to do so). Refer all servicing to your retailer, the nearest Roland Service Center, or an authorized Roland distributor, as listed on the "Information" page. 
- Never use or store the unit in places that are: 
 - Subject to temperature extremes (e.g., direct sunlight in an enclosed vehicle, near a heating duct, on top of heat-generating equipment); or are 
 - Damp (e.g., baths, washrooms, on wet floors); or are
 - Humid; or are
 - Exposed to rain; or are
 - Dusty; or are
 - Subject to high levels of vibration.

WARNING

- Do not allow any objects (e.g., flammable material, coins, pins); or liquids of any kind (water, soft drinks, etc.) to penetrate the unit.  
- In households with small children, an adult should provide supervision until the child is capable of following all the rules essential for the safe operation of the unit. 
- Protect the unit from strong impact. (Do not drop it!) 
- DO NOT play a CD-ROM disc on a conventional audio CD player. The resulting sound may be of a level that could cause permanent hearing loss. Damage to speakers or other system components may result. 

CAUTION

- Never climb on top of, nor place heavy objects on the unit. 

Important Notes

In addition to the items listed under “USING THE UNIT SAFELY” on page 3, please read and observe the following:

Placement

- Do not expose the unit to direct sunlight, place it near devices that radiate heat, leave it inside an enclosed vehicle, or otherwise subject it to temperature extremes. Excessive heat can deform or discolor the unit.

Before Using Cards

Using DATA Cards

- Insert the CompactFlash card correctly into the PC card adapter, and insert it all the way into the PC card slot.

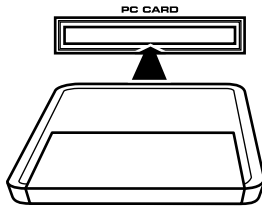

- Never touch the terminals of the CompactFlash and PC card adapter. Also, avoid getting the terminals dirty.

Handling CD-ROMs

- Avoid touching or scratching the shiny underside (encoded surface) of the disc. Damaged or dirty CD-ROM discs may not be read properly. Keep your discs clean using a commercially available CD cleaner.

Other Notes

- * All product names mentioned in this document are trademarks or registered trademarks of their respective owners.
- * CompactFlash and  are trademarks of SanDisk Corporation and licensed by CompactFlash association.
- * In the interest of product improvement, the specifications and/or contents of this package are subject to change without prior notice.
- * In this guide, we use the term “Owner's Manual” for you to refer to the “Fantom-X Owner's Manual”.

Contents

Check the contents of the package	8
Updating the Fantom-X	9
What is the FANTOM-X Audio Track Expansion Kit?	9
Items required for performing the update	9
Cautions when performing the update (Important)	9
Update procedure	10
Verifying the update	11
Main features	12
Using audio tracks	13
What are audio tracks?.....	13
To access the Audio Track Edit screen	14
To access the Audio Track Mixer screen	14
Items in the Audio Track Edit screen.....	15
Editing audio tracks (Audio Track Edit screen).....	16
Moving a sample event (Move).....	16
Selecting and auditioning a sample event (Preview)	16
Using the pads to mute audio tracks (Mute/Solo)	16
Viewing a list of markers (Marker List)	17
Opening the Loop/Locate window (Loop/Locate)	17
Inserting a sample event at a specified location (Insert)	17
Deleting the selected sample event from an audio track (Delete).....	18
Copying a sample event (Copy).....	18
Unloading a sample (Unload Sample).....	18
Combining the contents of the tracks into one audio track (Mixdown)....	18
Erasing audio tracks (Clear).....	19
Naming an audio track (Track Name).....	20
Switching the display mode.....	20
Zooming In and Zooming Out in the display	20
Editing MIDI tracks	20
Items in the Audio Track Mixer screen	21
Controlling the audio tracks (Audio Track Mixer screen).....	22
Controlling the audio track settings	22
Using the knobs to control the mixer.....	23
Opening the Loop/Locate window (Loop/Locate)	23
Using the pads to mute audio tracks (Mute)	23
Recording an audio track.....	24
Recording an audio track (SOLO/RE-SAMPLING).....	24
Combining multiple audio tracks into one track (AUDIO MERGE)	25
Saving your audio tracks.....	26

Using the Skip Back Sampling function.....	27
What is Skip Back Sampling?.....	27
Using Skip Back Sampling.....	27
Editing the data created by Skip Back Sampling	28
Isolating the desired portion of the sampled data (Start Beat/End Beat).....	28
Cancelling the sample (Skip Back Cancel).....	28
Assigning the sampled waveform to the keyboard or a pad (Assign to Keyboard/Pad).....	28
Assigning the sampled waveform to an audio track (Assign to Audio Track)	29
Multisample editing functions.....	30
Creating a multisample.....	30
Creating a multisample in the Patch Edit screen	31
Creating a multisample in the Create Multisample screen	31
Editing a multisample.....	33
About the Multisample Edit screen	33
Selecting the notes to edit.....	34
Changing the multisample assigned to a tone (List).....	34
Erasing the data from the selected region of notes (Erase).....	34
Assigning a sample to the selected region (Assign)	34
Copying a sample from a key to another key (Copy)	35
Opening the Tone Switch/Select window (Tone Sw/Sel)	35
Moving the split point (Split Point)	35
Returning a multisample to the last-written state (Reload)	36
Erasing all notes (Erase All)	36
Replacing the sample of the current zone (Sample Select).....	36
Specify the original key (Org Key) of the sample	37
Sorting samples in the order of their original key (Sort)	37
Moving all samples to left or right (Shift)	37
Moving the data of the current zone to left or right (Move)	37
Saving a multisample.....	38
Sample-related changes	39
Extended patch groups.....	39
Saving a sample auto patch.....	39
Bank Select and Program Change Correspondence Chart.....	39
Newly added sample parameters	40
Sample BPM calculator (BPM Calc).....	40
Selecting a sample (Sample Number).....	40
Changes in the saved sample content (Save All Samples).....	40
Changes in the Patch/Rhythm Edit screen	41
Newly added Patch Overview screen	41

Changes due to the upgraded editor software	42
Newly added PC mode screen.....	42
Cautions when using S-700 series sounds with the Fantom-X	42
Before you connect the Fantom-X to your computer	42
Importing patches and rhythm sets	43
Fantom-X Editor System Requirements	45
System Requirements (Windows).....	45
System Requirements (Mac OS)	45
About the included USB MIDI driver.....	45
Other changes	46
Changes in the Patch Edit screen.....	46
Changes in the Performance Mixer screen.....	47
Changes in the Performance Layer screen	47
Newly added Layer List window	47
Changes in the Key Range window	48
Playing different sounds across the keyboard (Split).....	48
Changes in the Song Edit screen.....	48
Changes in the Song List screen	49
Deleting a Song	49
Using the pads for realtime erase	49
CC Filter added to the Microscope.....	50
Improved functionality for step recording	50
Changes in the demo song loaded when you start up the Fantom-X.....	50
Improved functionality in Live Setting	51
Registering a song file in a Live Setting	51
Recalling a song file you registered	52
Switching the font.....	52
Removing the text.....	52
Improvements in Arpeggio functionality	52
Using the pads to switch arpeggio styles.....	52
Changing the arpeggio styles assigned to the pads	53
Improvements in Chord Memory functionality.....	53
Using the pads to switch chord forms.....	53
Changing the chord forms assigned to the pads.....	54
Changes in the librarian.....	54
New shortcut from the Input Setting screen to MFX Edit.....	55
New parameters available for the assignable switches.....	55
Newly added DIMM check function	56
Index	57

Check the contents of the package

This package contains the following items. As soon as you open the package, please make sure that all items are present. You may wish to check off () each box as you verify each item. If anything is missing, please contact your dealer.

* *This page is for verifying the contents of the FANTOM-X Audio Track Expansion Kit (update card). If you purchased the Fantom-X (synthesizer workstation), please begin reading from "Main features" (p. 12).*

FANTOM-X Audio Track Expansion Kit CompactFlash card

For the update procedure, refer to "Updating the Fantom-X" (p. 9).

PC card adapter

This is an adapter for inserting the "FANTOM-X Audio Track Expansion Kit" CompactFlash card into the Fantom-X synthesizer.

CD-ROM (Editor)

Fantom-X Sound List (Leaflet)

Guide to the Added Functionality (this document)

This is the document you are reading. It explains the functionality added by the FANTOM-X Audio Track Expansion.

Sticker

Updating the Fantom-X

What is the FANTOM-X Audio Track Expansion Kit?

The FANTOM-X Audio Track Expansion Kit consists of a CompactFlash card containing an upgrade program that adds audio tracks to your Fantom-X and enhances the multisample functionality, together with a PC card adapter for inserting this card into your Fantom-X. Once you perform the update procedure, the Fantom-X will always start up with the added FANTOM-X Audio Track Expansion functionality.

NOTE

Keep this product in a safe place after you have completed the upgrade.

Items required for performing the update

- “FANTOM-X Audio Track Expansion Kit” CompactFlash card and PC card adapter (hereafter referred to as “this product”)
- Fantom-X6/X7/X8 synthesizer workstation

NOTE

Use only the CompactFlash card and PC card adapter included with this product.

Cautions when performing the update (Important)

- Never use this product with any device other than the Fantom-X. Doing so may damage the data or system of this product or of the other device.
- Do not turn off the power while the update is in progress. Doing so may render the Fantom-X incapable of starting up correctly.
- As a precaution, we recommend that you back up your user data before you begin. (Owner’s Manual; p. 235)
- Do not format this product on the Fantom-X or on any other device.
- Please note that once you have completed the update using this product, it will not be possible to return the Fantom-X to its prior version.
- Once you have completed the update, do not insert this product into the Fantom-X.

The files contained in this product may not be reproduced, modified, or included in any magazine or commercial product without the permission of Roland Corporation.

Update procedure

1. Insert the “FANTOM-X Audio Track Expansion Kit” CompactFlash card into the PC card adapter.

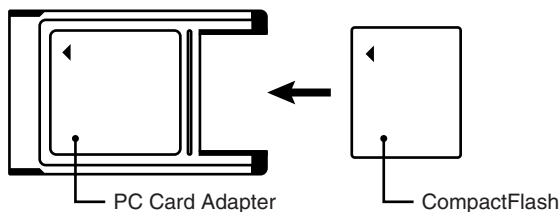

2. Make sure that your Fantom-X is switched OFF.
3. Insert the PC card adapter (see step 1) into the Fantom-X.
4. Switch ON the power on your Fantom-X.

After the opening movie is displayed, a caution regarding the update procedure will appear.

* If the screen shown below does not appear, switch off the Fantom-X's power, and repeat the operation from step 1.



5. Read the warning, and if you wish to proceed, press [F7 (OK)].

* If you wish to abort the update procedure at this point, press [F1 (EXIT)], turn off the power, and remove the PC card.

A screen will ask you for confirmation.



6. Press [F8 (UPDATE)] to execute the update.

- * *If you wish to abort the update procedure at this point, press [F1 (EXIT)], turn off the power, and remove the PC card.*
- * *Do not turn off the power while the update is in progress.*
- * *The update will require approximately two minutes for completion.*

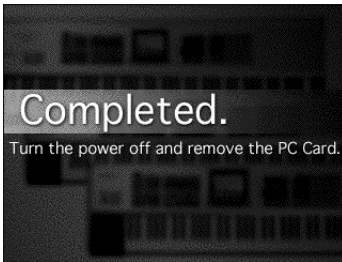
7. When the process has been completed, the following screen will appear. Turn off the power of the Fantom-X and remove the PC card.

This completes the update.

The next time you turn on the power, the FANTOM-X Audio Track Expansion will start up.

MEMO

Keep this product in a safe place after you have completed the upgrade.

Verifying the update

- 1. Press [MENU] to access the Menu window.**
- 2. Use ▲ ▼ to choose "System," and then press [ENTER].**

The System Setup screen will appear.

- 3. Press [F4 (Info)].**

The System Information screen will appear.

- 4. Use [F1 (↑)][F2 (↓)] to choose the "Version Info" tab.**

Verify that the version indication in the lower right of the Version Info screen reads "Version 2.**" (2.00 or higher).

Main features

The Fantom-X Audio Track Expansion adds audio tracks, providing a significant leap in music-making power. With its comprehensive unification of synth, sampler, and audio functionality, the Fantom-X is reborn as an even more powerful music workstation.

Audio tracks (p. 13)

Eight dedicated audio tracks (stereo) have been added to the sequencer of the Fantom-X series. This lets you use recorded or imported audio phrases directly in your songs. In addition to the ability to play back a sample from midway (not just from its beginning), each track provides a Timestretch function which allows the audio to follow tempo changes.

Sample Auto Patch function (p. 39)

As with patches and rhythm sets, you can now easily select samples from the patch list as well. New sample parameters have also been added, making it much easier to handle samples.

Multisample editing (p. 30)

The new Multisample Edit screen lets you easily create and edit multisamples.

Sample Editor, Multisample Editor, and S-700 series sample converter (p. 42)

The included editors have been significantly expanded. You can now use your computer to directly edit samples and multisamples inside the Fantom-X. In addition, you can now load S-700 series data.

New patches

* *128 new patches have been added.*

Many other functions have been added, making the Fantom-X even more powerful and easier to use. In order to take full advantage of its dramatically enhanced functionality, please read this guide carefully.

Using audio tracks

What are audio tracks?

Eight dedicated audio tracks (stereo) have been added to the sequencer of the Fantom-X series. This lets you use recorded or imported audio phrases directly in your songs. The audio tracks are “time-stretched” so that they will stay in synchronization even if the tempo changes during the song. The audio tracks can also be played back from midway through an event.

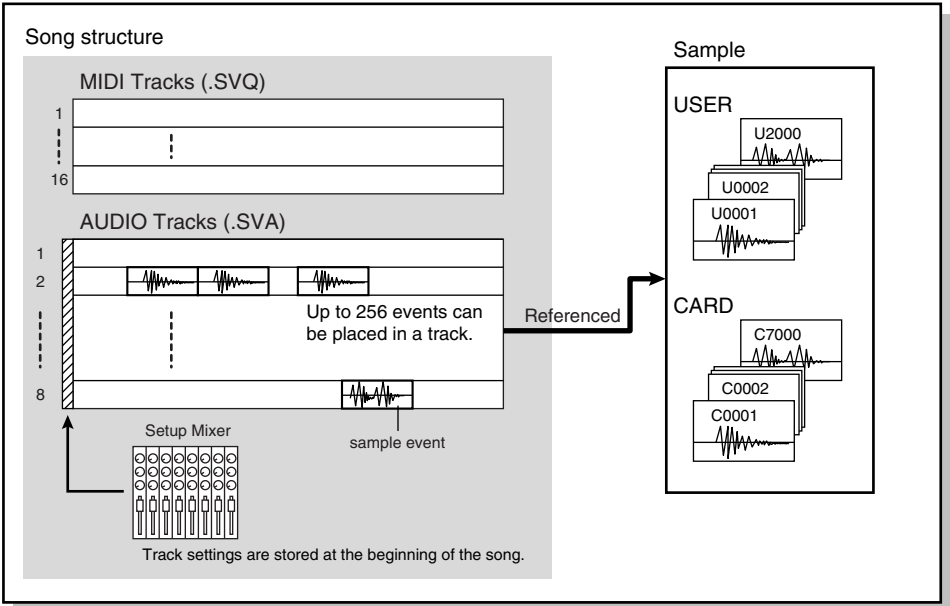

An audio track in a song does not directly record samples. Instead, the audio track contains references to samples, and plays the samples via these references. In other words, the audio track merely contains data (a “sample event”) that says “play User (or Card) sample number ‘x’ at this point,” and even if you delete the sample event from an audio track, the sample data itself will remain.

Up to 256 sample events can be placed on each audio track.

* Each audio track can play only one sample at a time. If you place sample events on a track so that they overlap, the later event will be heard.

You will use the following two screens to edit audio tracks.

- **Audio Track Edit screen**

Here you can edit each audio track.

- **Audio Track Mixer screen**

In this screen you can adjust the mixing of the audio tracks, such as their level and pan.

NOTE

In order to play back an audio track, the song must be loaded into the temporary area (Owner's Manual; p. 177). Audio tracks will not play back when using the Quick Play function (Owner's Manual; p. 164) or Chain Play function (Owner's Manual; p. 165).

NOTE

Patterns (Owner's Manual; p. 31) do not have audio tracks.

To access the Audio Track Edit screen

1. Press [SONG EDIT].
2. Press [F3 (Audio Track)].

The Audio Track Edit screen will appear.



cf.

"Items in the Audio Track Edit screen" (p. 15)

To access the Audio Track Mixer screen

1. With the Audio Track Edit screen displayed, press [F1 (Audio Mixer)].

The Audio Track Mixer screen will appear.



2. Press [F6] to switch the Audio Track Mixer screens.



cf.

"Items in the Audio Track Mixer screen" (p. 21)

Items in the Audio Track Edit screen

Audio Track Edit Screen

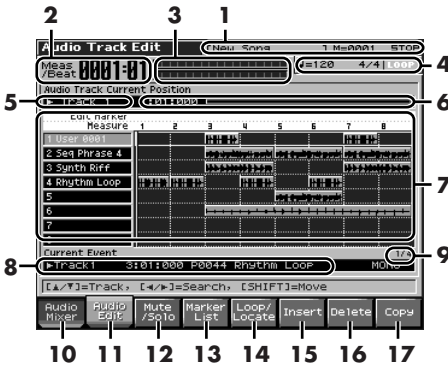

1. Indicates the name of the currently selected song, the measure location, and the status of the sequencer.
2. Indicates the current location of the audio track.
3. Audio level meter.
4. Indicates the song's time signature, tempo, and loop play on/off status.
5. Indicates the currently selected audio track.
6. Indicates the current location.
7. Indicates the name, contents, and markers of audio tracks.
If the audio file referenced by the selected sample event has not been loaded, the file name is displayed in the sample event.
8. Shows details of the currently selected event.
If this indicates "unload," the audio file referenced by the selected sample event has not been loaded.
9. Indicates the order of the currently selected sample event within all events of the currently selected audio track.
If there are overlapping events at the same time location, this is indicated by a red frame, and the later event will be given priority for playing.
10. Displays the Audio Track Mixer screen (p. 14).

If you hold down [SHIFT]

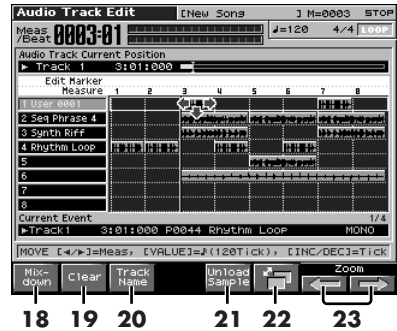

11. Displays the Audio Track Edit screen (p. 14).
12. Lets you use the pads to mute audio tracks (p. 16).
13. Displays the marker list (p. 17).
14. Opens the Loop/Locate window (p. 17).
15. Inserts a sample event at the specified location (p. 17).
16. Deletes the selected sample event (p. 18).
17. Copies the sample event (p. 18).
18. Combines the contents of the tracks into a single audio track (p. 18).
19. Erases audio tracks (p. 19).
20. Names an audio track (p. 20).
21. Unloads the sample (p. 18).
22. Switches the display mode (p. 20).
23. Zooms in/out in the display (p. 20).

Editing audio tracks (Audio Track Edit screen)

Moving a sample event (Move)

Here's how to move the currently selected sample event to another track or location.

1. Use [CURSOR] to select the sample event you want to move.

The selected event is displayed in orange.

2. Press [SHIFT].

The cursor will change shape as follows.



3. While continuing to hold down [SHIFT], press ▲ or ▼.

Move the sample event to the desired track.

4. While continuing to hold down [SHIFT], use the following buttons to move the sample event to the desired location.

- [INC][DEC]
Move the sample event in steps of one tick.
- ◀ ▶
Move the sample event in steps of one measure.
- VALUE dial
Move the sample event in steps of 16th note (120 ticks).

Selecting and auditioning a sample event (Preview)

1. Use ▲ ▼ to select a track.
2. Press [ENTER].

The sample in the track you selected in step 1 that is closest to the current location will be selected.

While the play is stopped, you can audition (preview) the sample by continuing to hold down [ENTER].

Using the pads to mute audio tracks (Mute/Solo)

You can use the pads to switch muting on/off for the audio tracks.

Pad numbers 1–8 correspond to audio track numbers 1–8.

1. Press [F3 (Mute/Solo)].

The Muting Audio Tracks with Dynamic Pads window will open.

In this state, the pads will function as mute on/off buttons. Each time you press a pad, muting will be enabled or disabled.

- Pad blinking: muted
- Pad lit: un-muted

MEMO

You can “solo” tracks 1–8 by pressing pads 9–16.

MEMO

You can press [F6 (All Mute)] to mute all audio tracks. Press [F7 (All Play)] to un-mute all audio tracks.

Viewing a list of markers (Marker List)

You can assign markers to desired measures within a song. This gives you a visual indication of the structure of your song, and is a real convenience when editing audio tracks since you can move rapidly to a desired marker. Here's how you can view a list of the markers in the song, and edit the markers.



1. Press [F4 (Marker List)].

The Edit Marker List window will appear.

The buttons have the following functions.

- VALUE dial, [INC][DEC], ▲ ▼
Select a marker within the list. The current location will jump accordingly.
- [F5 (Set)]
Adds a marker at the beginning of the current measure.
- [F6 (Clear)]
Deletes the selected marker.
- [F7 (Name)]
Assigns a name to the currently selected marker. Choose a name from the displayed list, and press [F7 (Name)] to finalize your choice.



2. Press [F8 (Close)] to close the window.

MEMO

You can press pads 1–16 to jump to the marker of the corresponding number.

Opening the Loop/Locate window (Loop/Locate)

1. Press [F5 (Loop/Locate)].

The Loop/Locate window will appear.

* For details on operations in the Loop/Locate window, refer to p. 179 of the owner's manual.

Inserting a sample event at a specified location (Insert)

1. Use ▲ ▼ to select the audio track into which you want to insert a sample event.

2. Specify the location at which you want to insert a sample event.

The buttons have the following functions.

- [RESET]
Moves the current location to the beginning of the song.
 - [INC][DEC]
Move the current location in steps of one tick.
 - [BWD][FWD]
Move the current location in steps of one measure.
 - VALUE dial
Moves the current location in steps of 1 beat.
- ### 3. Press [F6 (Insert)].
- The Sample Select screen will appear.
- ### 4. Select the sample event that you want to insert, and press [F8 (Select)].

The sample event will be inserted at the location you specified.

MEMO

If inserting the sample event would exceed the current length of the song, a screen will ask you whether you really want to extend the length of the song.

When you press [F8 (Exec)], the song will automatically be lengthened as necessary to accommodate the newly inserted sample event.

Deleting the selected sample event from an audio track (Delete)

1. Use [CURSOR] to select the sample event that you want to delete from an audio track.
2. Press [F7 (Delete)].
The selected sample event will be deleted from the track.
** This merely deletes the sample event; the sample data itself will remain in the sample list.*

Copying a sample event (Copy)

Here's how to copy the currently selected sample event.

1. Use [CURSOR] to select the sample event that you want to copy.
2. Press [F8 (Copy)].
The currently selected sample event will be copied to a location immediately following itself.

MEMO

If copying the sample event would make the track exceed the current length of the song, a screen will ask you whether you really want to extend the length of the song.

When you press [F8 (Exec)], the song will automatically be lengthened as necessary to accommodate the newly copied sample event.

Unloading a sample (Unload Sample)

This operation deletes the currently selected sample event and also unloads it from the sample list.

1. Hold down [SHIFT] and press [F5 (Unload Sample)].
A message will ask you for confirmation.
2. Press [F8 (Exec)] to execute.
** If you decide to cancel, press [F7 (Cancel)].*

Combining the contents of the tracks into one audio track (Mixdown)

This operation lets you specify a region, then have the performance of all audio tracks and MIDI tracks in that region be combined into a single track.

After creating a sample in this way, you can save it on your computer as the audio data for a single song.

1. Hold down [SHIFT] and press [F1 (Mixdown)].
The [REC] indicator will blink, and the Mixdown Standby window will appear.
2. In the Mixdown Standby window, specify the region that you want to mix down.

Use [CURSOR] to move the cursor to each parameter, and turn the VALUE dial or use [INC][DEC] to set the value.



- **Start Point**
Specify the measure at which the mixdown is to start.
- **End Point**
Specify the measure at which the mixdown is to end.

3. Press [PLAY] or [F8 (Start)].

The Mixdown Standby window will close, and [REC] indicator will change from blinking to lit, and the mixdown will begin.

When the mixdown begins, the Mixdown window will appear.

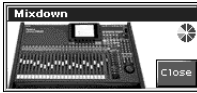

To close the Mixdown window, press [F8 (Close)] or [PLAY]. To open it again, press [PLAY].

4. The mixdown will end automatically.

The [REC] indicator will go out.

* You can also press [STOP] to stop before you reach the end.

5. The Mixdown Sample Assign window will open.



Use [RESET][BWD][FWD] or [CURSOR] to specify the location at which the sample event will be assigned.

6. Press [F8 (Assign)] to assign the sample event to the audio track.

A sample event that plays the mixed-down sample will be assigned to the audio track, and you will return to the previous screen.

- If you press [F6 (Unload)], the samples you just mixed down will be deleted (unloaded). A message will ask you for confirmation; press [F8 (Exec)] to confirm.
- If you want to neither assign nor unload the sample, press [F7 (Cancel)].

* Even if you cancel, the mixed-down sample data itself will remain in the sample list.

Erasing audio tracks (Clear)

1. Hold down [SHIFT] and press [F2 (Clear)].

The Audio Track Clear Menu window appears.



2. Turn the VALUE dial, or press [INC] [DEC] to select the menu.

• Clear All

All audio tracks will be erased. (The track names and setup data will also revert to their default settings.)

• Clear Track

The selected audio track will be erased. (The track name and setup data will also revert to its default settings.)

3. Press [F8 (Select)].

A message will ask you for confirmation.

4. Press [F8 (Exec)].

* If you decide to cancel, press [F7 (Cancel)].

* This operation will not change the length of the song.

Naming an audio track (Track Name)

Here's how to assign a name to an audio track (you can use up to twelve characters).

1. Use ▲ ▼ to select the audio track that you want to name.
2. Hold down [SHIFT] and press [F3 (Track Name)].

The Audio Track Name screen will appear.

3. Assign the desired name.

* For details on how to assign a name, refer to "Assigning a name" (Owner's Manual; p. 36).

4. Press [F8 (Write)] to confirm the name.

Switching the display mode

By holding down [SHIFT] and pressing [F6] you can cycle through the following three display modes.

• Wave Mode

Displays the waveform of the sample.



• Number Mode

Displays the sample numbers.



• Overview Mode

Displays the contents of the song in a "condensed" form that lets you view all of the audio tracks. This is a convenient way to view the overall structure of the song.



Zooming In and Zooming Out in the display

1. Hold down [SHIFT] and press [F7 (Zoom ⇐)] (reduce) / [F8 (Zoom ⇒)] (magnify).

You can zoom in/out to display between two and thirty-two measures in the screen.

Editing MIDI tracks

When you execute one of the MIDI track edit operations (Owner's Manual; p. 180) listed below, the audio tracks will also be edited at the same time.

- Delete (Owner's Manual; p. 184)
If you've selected Track/Pattern ALL
 - Copy (Owner's Manual; p. 184)
If you've selected Src Track/Pattern ALL
Dst Track/Pattern ALL
 - Insert (Insert measure) (Owner's Manual; p. 185)
If you've selected Track/Pattern ALL.
- * When editing an audio track in the Audio Track Edit screen, the "Undo/Redo" of the Menu window is not available.

Items in the Audio Track Mixer screen

Audio Track Mixer1 Screen

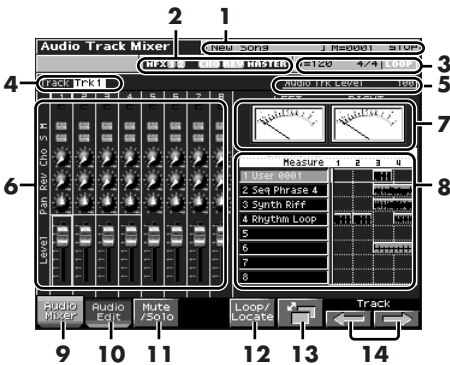

Audio Track Mixer2 Screen

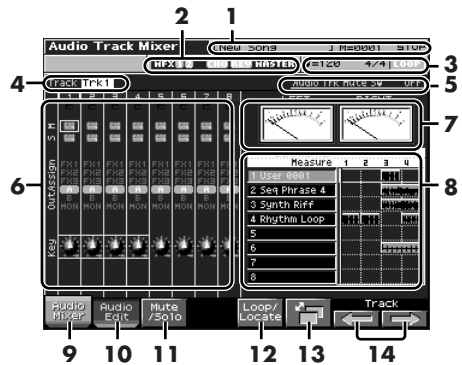

1. Indicates the name of the currently selected song, the measure location, and the status of the sequencer.
2. Indicates the on/off status of the multi-effects (MFX 1–3), chorus (CHO), reverb (REV), and mastering effect (MASTER).
3. Indicates the song's time signature, tempo, and loop play on/off status.
4. Indicates the number of the currently selected audio track.
5. Indicates the name and value of the currently selected parameter.
6. Shows the parameters that can be controlled for each audio track.
7. Audio level meters.
8. Displays a simplified view of the Audio Track Edit screen.
9. Displays the Audio Track Mixer screen (p. 14).
10. Displays the Audio Track Edit screen (p. 14).
11. Lets you use the pads to mute audio tracks (p. 16).
12. Displays the Loop/Locate window (p. 17).
13. Switches the Audio Track Mixer screens.
14. Selects the four audio tracks that will be controlled by the Realtime Control knobs (p. 23).

Controlling the audio tracks (Audio Track Mixer screen)

It's convenient to use the Audio Track Mixer screen when you want to adjust mixing parameters, such as the level and pan of the eight audio tracks.

Controlling the audio track settings

1. Access the Audio Track Mixer 1 or 2 screen.
2. Use ▲ ▼ to move the cursor to the parameter you want to edit.
3. Use ◀ ▶ to move the cursor to the audio track you want to edit.

Current track
Indicates the name and value of the parameter where the cursor is located.



4. Turn the VALUE dial or use [INC][DEC] to adjust the value.

MEMO

The green frame that encloses four tracks corresponds to the parameters controlled by the four REALTIME CONTROL knobs (p. 23).

Audio Track Mixer 1 Screen

Indication in the Mixer screen	Parameter
Level	Track Level Adjusts the volume of each audio track. This is used mainly to set the volume balance between audio tracks. Value: 0–127
Pan	Track Pan Adjusts the pan of each audio track. “L64” is far left, “0” is center, and “63R” is far right. Value: L64–0–63R
Rev	Track Reverb Send Level Adjusts the amount of signal sent from each audio track to the reverb. Value: 0–127
Cho	Track Chorus Send Level Adjusts the amount of signal sent from each audio track to the chorus. Value: 0–127
S	Solo Switch Plays only the specified audio track. Value: ON, OFF
M	Mute Switch Mutes (silences) the specified audio track. Value: ON, OFF

Audio Track Mixer 2 Screen

Indication in the Mixer screen	Parameter
S	Solo Switch Plays only the specified audio track. Value: ON, OFF
M	Mute Switch Mutes (silences) the specified audio track. Value: ON, OFF
Output Assign	Output Assign Specifies how the direct sound from each audio track will be output. Value MF1 1-3: The sound will be routed through the multi-effect and output in stereo. You can also apply chorus or reverb to the sound that has passed through the multi-effect. A, B: The sound will be output in stereo from the OUTPUT A (MDX) jacks or OUTPUT B jacks without passing through a multi-effect. MON: The sound will be output in stereo from the OUTPUT A (MDX) jacks without passing through a multi-effect. Use this setting if you want only to hear the sound without resampling or recording it.
Key	Audio Track Key Shift Adjusts the pitch of each track in semitone steps (+/-2 octaves). Value: -24+ +24

Using the knobs to control the mixer

In the Audio Track Mixer screen, you can use [F7(⇐)] [F8(⇒)] to select the four audio tracks that will be controlled by the REALTIME CONTROL knobs. The currently selected audio tracks are indicated by a light green frame around them. Use ▲ ▼ to select the parameter that you want to control.



Opening the Loop/Locate window (Loop/Locate)



Owner's Manual; p. 179

Using the pads to mute audio tracks (Mute)



p. 16

Recording an audio track

cf.

Owner's Manual; p. 168

Recording an audio track (SOLO/RE-SAMPLING)

Here's how to record the input from an AUDIO INPUT jack or from the internal sound generator.

1. In the Audio Track Edit screen, press [REC].

The [REC] indicator will blink, and the Audio Rec Standby window will appear.

2. Use the Audio Rec Mode (Audio Recording Mode) field to select the recording method you want to use.

Use [CURSOR] to move the cursor to Audio Rec Mode, and turn the VALUE dial or use [INC][DEC] to select the desired recording mode.

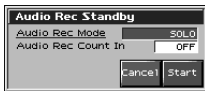

- **SOLO**

The internal sound generator will play as usual, and only the sound from the external audio input will be recorded.

* *You won't be able to apply effects to the external audio input.*

- **RE-SAMPLING**

The sound from the internal sound generator (including the audio tracks) will be recorded. The external audio input will not be heard.

* *The volume of a resampled phrase may be less than the original volume of the phrase. As necessary, use Normalize (Owner's Manual; p. 156) to raise the volume.*

* *Audio tracks whose Audio Track Output Assign (p. 23) parameter is set to MON (Monitor) will not be recorded.*

- **AUDIO MERGE**

Multiple audio tracks will be combined into one audio track. For details, refer to "Combining multiple audio tracks into one track (AUDIO MERGE)" (p. 25).

3. Use the Audio Rec Count In (Audio Recording Count In) field to specify how you want recording to start.

Use [CURSOR] to move the cursor to Audio Rec Count In, and turn the VALUE dial or use [INC][DEC] to choose the desired setting.



- **OFF**

Recording will start the moment you press [PLAY].

- **1 MEAS**

When you press [PLAY], there will be a count-in (playback) beginning one measure before the recording start point. Recording will start when you reach the recording start point.

- **2 MEAS**

When you press [PLAY], there will be a count-in (playback) beginning two measures before the recording start point. Recording will start when you reach the recording start point.

4. When you've chosen the desired setting in the Audio Rec Standby window, press [PLAY] or [F8 (Start)].

The Audio Rec Standby window will close, the [REC] indicator will change from blinking to steadily lit, and recording will start.

When recording starts, the Audio Recording window will appear.



To close the Audio Recording window, press [F8 (Close)] or [PLAY]. To open it once again, press [PLAY].

5. When you've finished recording, press [STOP].

The [REC] indicator will go dark.

6. The Audio Rec Sample Assign window will open.



Use [RESET][BWD][FWD] or [CURSOR] to specify the location to which the sample event is to be assigned.

7. Press [F8 (Assign)] to assign the sample event to the audio track.

A sample event that plays the recorded sample will be assigned to the audio track, and you will return to the previous screen.

- If you press [F6 (Unload)], the samples you just recorded will be deleted (unloaded). A message will ask you for confirmation; press [F8 (Exec)] to confirm.
- If you want to neither assign nor unload the sample, press [F7 (Cancel)].

* Even if you cancel, the recorded sample data itself will remain in the sample list.

Combining multiple audio tracks into one track (AUDIO MERGE)

A maximum of eight tracks are available for you to use. By combining (merging) several audio tracks, you can free up audio tracks for other uses.

When you record using AUDIO MERGE, all MIDI tracks will automatically be muted, and the audio tracks will be recorded according to their current Mute/Solo settings.

1. In the Audio Track Edit screen, mute any audio tracks that you don't want to merge.

2. Press [REC].

The [REC] indicator will blink, and the Audio Rec Standby window will appear.

3. In the Audio Rec Mode (Audio Recording Mode) field, choose "AUDIO MERGE."

Use [CURSOR] to move the cursor, and turn the VALUE dial or use [INC][DEC] to make the setting.



4. In the Audio Rec Count In (Audio Recording Count In) field, specify how you want recording to start.

Refer to step 3 of "Recording an audio track (SOLO/RE-SAMPLING)" (p. 24).

5. When you've finished making settings in the Audio Rec Standby window, press [PLAY] or [F8 (Start)].

The Audio Rec Standby window will close, the [REC] indicator will change from blinking to steadily lit, and recording will start.

When recording starts, the Audio Recording window will appear.



To close the Audio Recording window, press [F8 (Close)] or [PLAY]. To open it once again, press [PLAY].

6. When you've finished recording, press [STOP].

The [REC] indicator will go dark.

7. The Audio Rec Sample Assign window will open.



The location at which the recorded sample event is to be assigned will blink. Use [RESET][BWD][FWD] or [CURSOR] to specify the location at which you want to assign the sample event.

8. Press [F8 (Assign)] to assign the sample event to the audio track.

A sample event that plays the recorded sample will be assigned to the audio track, and you will return to the previous screen.

- If you press [F6 (Unload)], the samples you just recorded will be deleted (unloaded). A message will ask you for confirmation; press [F8 (Exec)] to confirm.
- If you want to neither assign nor unload the sample, press [F7 (Cancel)].

* Even if you cancel, the recorded sample data itself will remain in the sample list.

Saving your audio tracks

When you save a song that contains audio tracks, the audio track data is automatically saved in a file with a filename extension of “.SVA” and the same name as the song, together with the identically named “.SVQ” data file.



Owner's Manual; p. 223

(User, Card)

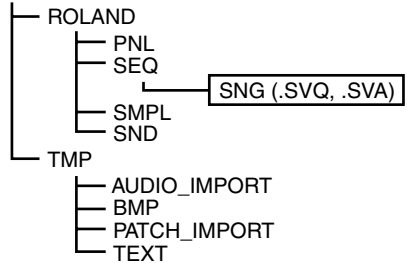

System Setup (Owner's Manual; p. 198) includes the following audio tracks' parameters.

- Level
- Output Assign
- Pan
- Mute/Solo
- Reverb Send
- Key Shift
- Chorus Send

* Changes in the parameter value are not recorded.



"Deleting a Song" (p. 49)

Using the Skip Back Sampling function

What is Skip Back Sampling?

Skip Back Sampling is a function that lets you sample what were playing immediately prior to that point, even if you were not recording.

When you press the SKIP BACK SAMPLING button, the performance that you were playing for a certain length of time before that moment will be sampled.

This is extremely convenient if you've been playing a phrase repeatedly, and want to sample it only after you've managed to play it correctly.

The FANTOM-X Audio Track Expansion makes it easier to handle the sample data created by Skip Back Sampling.



Owner's Manual; p. 145

Using Skip Back Sampling

1. **Perform on the Fantom-X's keyboard and/or pads, or connect an instrument or other device to the AUDIO IN jacks or DIGITAL IN, and input sound or phrases.**
2. **Press [SKIP BACK SAMPLING].**

The following screen will appear, and Skip Back Sampling will be carried out.

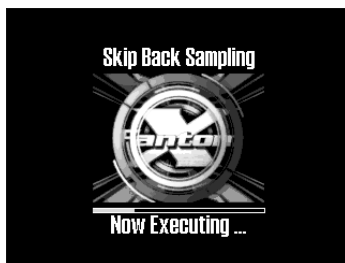

When Skip Back Sampling has been completed, the Skip Back Preview screen will appear.



Editing the data created by Skip Back Sampling

In the Skip Back Preview screen, you can isolate just the desired portion of the sample, and assign it to the keyboard or to an audio track.

Isolating the desired portion of the sampled data (Start Beat/End Beat)

1. In the Skip Back Preview screen, use [F1]–[F4] to isolate the desired portion of the sample.

The buttons have the following functions.

- [F1 (⇐)]/[F2 (⇒)] (Start Beat)
Move the start point of the sample forward or backward in steps of one beat. (When you move the Start point, the End point will also move in tandem.)
- [F3 (⇐)]/[F4 (⇒)] (End Beat)
Move the end point of the sample forward or backward in steps of one beat.

Cancelling the sample (Skip Back Cancel)

1. In the Skip Back Preview screen, press [F5 (SkipBkCancel)].

A message will ask you for confirmation.

2. Press [F8 (Exec)].

The sampled waveform will be erased (unloaded) from memory, and you will return to the previous screen.

If you decide to cancel, press [F7 (Cancel)].

Assigning the sampled waveform to the keyboard or a pad (Assign to Keyboard/Pad)

1. In the Skip Back Preview screen, press [F6 (Assign KB/Pad)].

The Assign to Kbd/Pad window will appear.



- To assign the sample to the keyboard
Press [F6 (Assign to Kbd)].
For the subsequent steps, refer to p. 152 of the owner's manual.
- To assign the sample to a pad
Press [F7 (Assign to Pad)].
For the subsequent steps, refer to p. 151 of the owner's manual.

If you decide to cancel, press [F8 (Cancel)].

Assigning the sampled waveform to an audio track (Assign to Audio Track)

1. In the Skip Back Preview screen, press [F7 (Assign Audio)].

The Audio Track Edit screen will appear, and the Skip Back Sample Assign window will open.



Use [RESET][BWD][FWD] or [CURSOR] to specify the location at which the sample is to be assigned.

2. Press [F8 (Assign)] to assign the sample to a track.
3. Press [F8 (Exec)].

The recorded sample data will be assigned to the selected track, and you will return to the previous screen.

If you decide to cancel, press [F7 (Cancel)].

Multisample editing functions

cf.

Owner's Manual; p. 153

The FANTOM-X Audio Track Expansion adds a Multisample Edit screen that makes it easy to create and edit multisamples.

Creating a multisample

A "multisample" is a set of different samples assigned to the notes of the keyboard. One multisample can split up to 128 samples across the keyboard. You can store 128 multisamples in user memory, and another 128 multisamples in a memory card.

* *In order to hear a multisample, you must assign it to a patch.*

How patches, multisamples, and samples are related

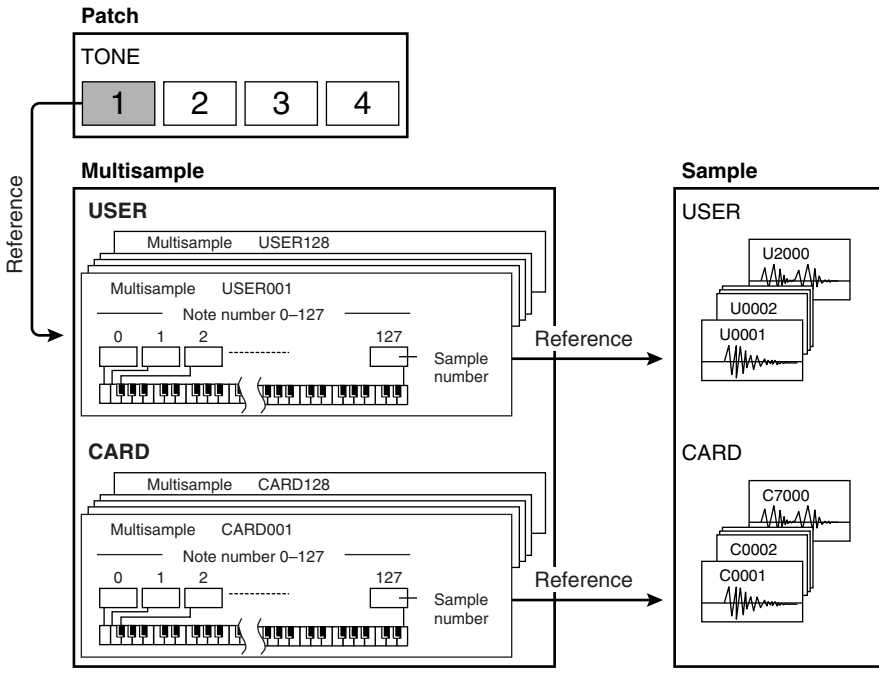

NOTE

User multisamples consist only of user samples, and card multisamples consist only of samples on the card.

Creating a multisample in the Patch Edit screen

MEMO

You should start by initializing the patch settings. (Owner's Manual; p. 57)

1. Press **[PATCH/RHYTHM]** to get the **Patch Play** screen.

MEMO

You can't create a multisample if the patch type is "Rhythm."

2. Press **[PATCH EDIT]**.
 3. Press **[F6 (Pro Edit)]**.
- The Patch Edit screen will appear.
4. Press **[F1 (↑)]** or **[F2 (↓)]** to select "Wave."
 5. Set the parameters as follows to assign the multisample to the desired Tone 1–4.

- **Wave Group:** MSAM (Multisample waveforms)
- **Wave Bank:** USER or CARD
- **Wave No. L (Mono):** Multisample number

* For details on making this setting, refer to "How to Make Patch Settings" (Owner's Manual; p. 56).

* If you want to use a stereo multisample, specify the same number for L and R.

6. Press **[F4 (Multisample Edit)]**.

The Multisample Edit screen will appear.

* For details on editing, refer to "Editing a multisample" (p. 35).

7. Save the multisample.

* For details on how to save, refer to "Saving a multisample" (p. 40).

8. Save the patch.

* For details on how to save the patch, refer to "Saving Patches You've Created (Write)" (Owner's Manual; p. 59).

Creating a multisample in the Create Multisample screen

1. Press **[SAMPLE LIST]** to get the **Sample List** screen, and select the sample(s) of which you want the multisample to consist.

Press **[F5 (Mark Set)]** to assign a check mark (✓) to the desired sample or samples. You can press **[F4 (Mark Clear)]** to remove the check mark.

You can press **[F8 (Preview)]** to audition the sample.

If the total number of marks exceeds 128, the multisample will be created using the first 128 samples, starting with the lowest-numbered sample.

* You cannot create a multisample that uses samples belonging to different groups.

2. Press **[F7 (Load Utility)]**, and then press **[F3 (Create Multi-Sample)]**.

The Create Multisample screen will appear.

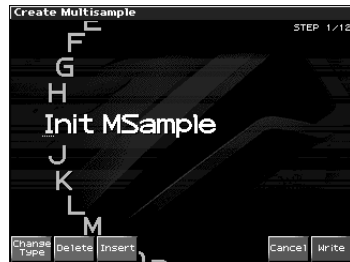

3. Assign a name.

* For details on how to assign a name, refer to "Assigning a Name" (Owner's Manual; p. 36).

- When you've finished inputting the name, press [F8 (Write)].

A screen will appear, allowing you to select the write destination.

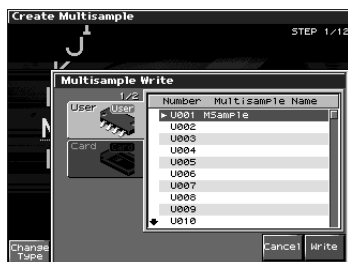

- Turn the VALUE dial or use [INC][DEC] to select the write destination.

Multisamples consisting of user samples will be written to User memory, and multisamples consisting of card samples will be written to Card memory.

- Press [F8 (Write)].

A message will ask you to confirm the Write operation.

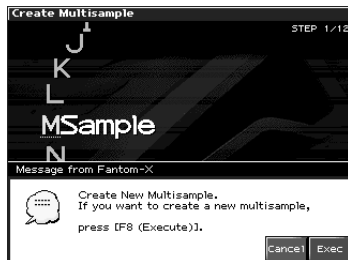

- If you are sure you want to write the multisample, press [F8 (Exec)].

Never turn off the power while data is being written.

- When the multisample has been written, the Assign to Keyboard window will appear.

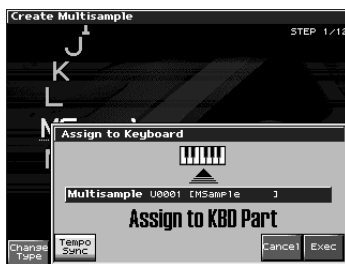

- If you're in Performance mode, a screen will appear, allowing you to select the Part to which the multisample is to be assigned. Use ▲ or ▼ to select a part, and then press [F8 (Select)].

- Press [F8 (Exec)].

A screen will ask you for confirmation. If you decide to cancel, press [F7 (Cancel)].

- Press [F8 (Exec)] once again.

Never turn off the power while data is being written.

- The Multisample Edit screen will appear.

- For details on editing, refer to "Editing a multisample" (p. 35).

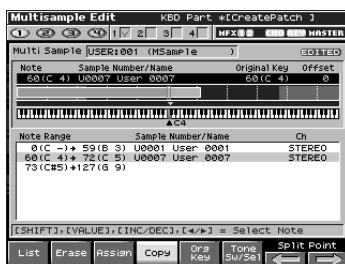

- Save the multisample.

- For details on how to save, refer to "Saving a multisample" (p. 40).

- Save the patch.

- For details on how to save a patch, refer to "Saving Patches You've Created (Write)" (Owner's Manual; p. 59).

Editing a multisample

About the Multisample Edit screen

Multisample Edit Screen

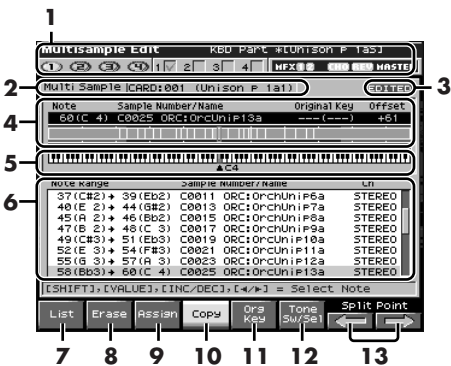

If you hold down [SHIFT]

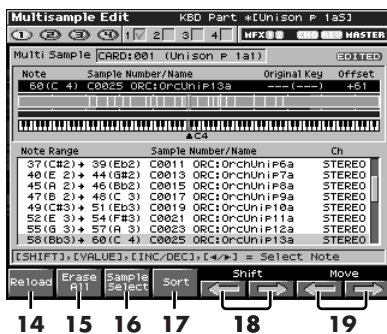

1. Shows information about the patch.
2. Shows the name of the multisample.
3. Indicates whether the multisample has been edited.
4. Shows information about the current note.
5. Indicates the original key of the sample.
6. Shows a list of the samples assigned to the multisample.
7. Changes the multisample assigned to a tone (p. 34)/
8. Erases the data from the selected region of notes (p. 34).
9. Assigns a sample to the selected region (p. 34).
10. Copies a sample from a key to another key (p. 35).

11. Specifies the original key of the sample (p. 37).
12. Opens the Tone Switch/Select window (p. 35).
13. Moves the split point (p. 35).
14. Returns a multisample to the last-written state (p. 36).
15. Erases all notes (p. 36).
16. Assigns a sample to the current zone (p. 36).
17. Sorts samples in a multisample in the order of their original key (p. 37).
18. Moves all samples to left or right (p. 37)
19. Moves the data of the current zone to left or right (p. 37).

Selecting the notes to edit

1. Press the keyboard to select the sample you want to edit.

You can select a region by pressing two notes.



You can also make your selection by turning the VALUE dial, by using ◀ ▶, or by using [INC][DEC]. In this case, hold down [SHIFT] to select a region of notes.

Changing the multisample assigned to a tone (List)

Here's how you can change the multisample that's assigned to the current tone.

1. In the Multisample Edit screen, press [F1 (List)].

The Multisample List window will open.

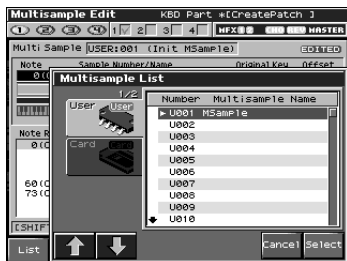

The buttons have the following functions.

- Value, ▲ ▼, [INC][DEC]
Change the number of the multisample to be assigned.
- [F2 (↑)]/[F3 (↓)]
Change the group of the multisample to be assigned.
- [F7 (Cancel)] or [EXIT]
Cancel the operation and return to the previous screen.
- [F8 (Select)]
Assigns the selected multisample to the current tone, and return to the previous screen.

Erasing the data from the selected region of notes (Erase)

1. In the Multisample Edit screen, press [F2 (Erase)].

The data for the selected region of notes will be erased.

Assigning a sample to the selected region (Assign)

1. In the Multisample Edit screen, press [F3 (Assign)].

The Sample Select screen will appear, allowing you to assign the selected sample to the selected region.

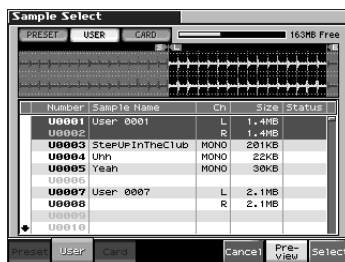

The buttons have the following functions.

- [F2 (User)] [F3 (Card)]
Select the group of the sample to be assigned.
- [F6 (Cancel)] or [EXIT]
Cancel the operation and return to the previous screen.
- [F7 (Preview)]
Auditions the sample.
- [F8 (Select)]
Selects the sample and return to the Multisample Edit screen.

Copying a sample from a key to another key (Copy)

Here's how the sample assigned to a note can be copied to a different note of the keyboard.

1. In the Multisample Edit screen, press the key to which the copy-source sample is assigned.

You can also select the note by using VALUE, ▲, ▼, or [INC][DEC].

The Sample Data area shows information about the sample assigned to the current note.

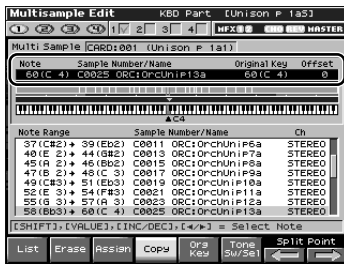

2. Press [F4 (Copy)] so it lights in red.
3. Press the copy-destination key.

If you specify a region by pressing more than one key, the data will be copied to the region between the lowest and highest keys you press.

4. Take your hand off the keyboard.

[F4 (Copy)] will go dark, and you will return to the normal Multisample Edit screen.

Opening the Tone Switch/Select window (Tone Sw/Sel)

1. In the Multisample Edit screen, press [F6 (Tone Sw/Sel)].

The Tone Switch/Select window will open.

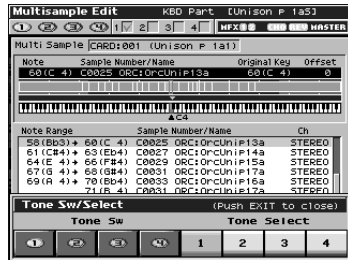

This is the same as when you press [F5 (Tone Sw/Sel)] in the Patch Play screen.

2. Press [EXIT] to close the window.

Moving the split point (Split Point)

The "Split Point" is the boundary between zones (p. 36).

1. In the Multisample Edit screen, press [F7 (Split←)][F8 (Split⇒)].

The split point of the selected sample and the adjacent sample will move to left or right.

Returning a multisample to the last-written state (Reload)

Here's how you can return the currently edited multisample to the state in which it was last written.

1. In the Multisample Edit screen, hold down [SHIFT] and press [F1 (Reload)].

A screen will ask you for confirmation.

2. Press [F8 (Exec)].

If you decide to cancel, press [F7 (Cancel)].

Erasing all notes (Erase All)

Here's how to erase all notes.

1. In the Multisample Edit screen, hold down [SHIFT] and press [F2 (Erase All)].

A screen will ask you for confirmation.

2. Press [F8 (Exec)].

If you decide to cancel, press [F7 (Cancel)].

Replacing the sample of the current zone (Sample Select)

A "zone" is a region to which the same sample is assigned. Here's how to assign a sample to the currently selected zone (the "current zone").

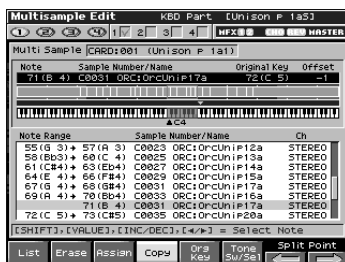

1. In the Multisample Edit screen, hold down [SHIFT] and press [F3 (Sample Select)].

The Sample Select screen will appear, allowing you to assign the selected sample to the current zone.



The buttons have the following functions.

- [F2 (User)]/[F3 (Card)]
You will see only the groups of samples that can be selected.
- [F6 (Cancel)] or [EXIT]
Cancel the operation and return to the previous screen.
- [F7 (Preview)]
Auditions the sample.
- [F8 (Select)]
Selects the sample and return to the Multisample Edit screen.

Specify the original key (Org Key) of the sample

Samples you record or import are set so that they will play at their original pitch when you press the C4 note.

In order to correctly match the key of the sample to the keyboard, you must modify the “original key” of the sample.

For example, if you sampled a sound whose pitch was E4, you’ll need to change its “original key” setting to E4 so that it will play at its original pitch when you press the E4 note of the keyboard.

Similarly, when you execute Create Multisample, you will need to specify the original key of the samples that make up that multisample, so that they are correct for the keys to which they are assigned.

* A sample will not play more than two octaves higher than its original key.

1. In the Multisample Edit screen, press [F5 (Org Key)].

The Original Key window will open.

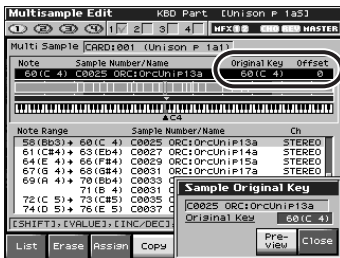

The buttons have the following functions.

- Value, [INC][DEC]
Change the original key of the sample assigned to the current note.
- [F7 (Preview)]
The sample will play at its current original key while you continue holding down the button.
- [F8 (Close)]
Closes the Original Key window.
- Keyboard
When you play the keyboard, the original key of the sample assigned to the most recently pressed note will be displayed.

2. Save the sample whose original key you changed.

* For details on saving a sample, refer to “Saving a Sample” (Owner’s Manual; p. 159).

Sorting samples in the order of their original key (Sort)

This operation reassigns all samples currently assigned to the multisample, so that they are placed in the order of their original key setting. (This produces the same result as Create Multisample.)

1. In the Multisample Edit screen, hold down [SHIFT] and press [F4 (Sort)].

A screen will ask you for confirmation.

2. Press [F8 (Exec)].

If you decide to cancel, press [F7 (Cancel)].

Moving all samples to left or right (Shift)

Here’s how all samples assigned to notes can be shifted to the left or right.

1. In the Multisample Edit screen, hold down [SHIFT] and press [F5 (←)][F6 (⇒)].

Moving the data of the current zone to left or right (Move)

Here’s how the sample of the current zone can be moved to left or right.

1. In the Multisample Edit screen, hold down [SHIFT] and press [F7 (←)][F8 (⇒)].

Saving a multisample

Once you've edited a multisample, the word "EDITED" appears beside the multisample name.

Be aware that if you turn off the power or select another screen when the "EDITED" indication is shown, the changes you made to the multisample will be lost.

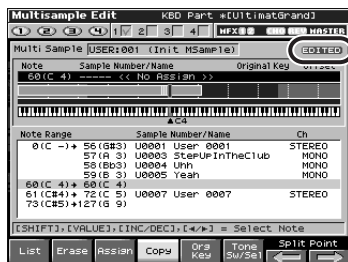

1. In the Multisample Edit screen, press [WRITE].

The Multisample Name screen will appear.

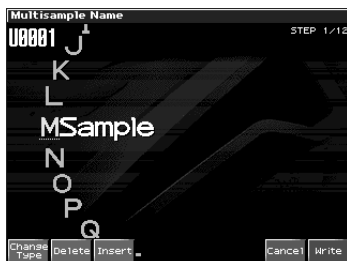

2. Assign a name to the multisample.

* For details on how to assign a name, refer to "Assigning a Name" (Owner's Manual; p. 36).

3. When you've finished inputting a name, press [F8 (Write)].

The Multisample Write window will appear.



4. Turn the VALUE dial or use [INC][DEC] or ▲ ▼ to select the multisample number of the write destination.

5. Press [F8 (Write)].

A message will ask you to confirm the Write operation.

6. To write the data, press [F8 (Exec)].

If you decide to cancel, press [F7 (Cancel)]. The multisample will be written, and you will return to the Multisample Edit screen.

NOTE

Never turn off the power while data is being written.

Sample-related changes

Extended patch groups

You can now select samples (card/user) from the patch list as well (Sample Auto Patch). This allows you to play a sample in a pitched manner just as you would play a normal patch.



The following two groups have been added to the patch groups. If there are samples in memory, sample names will be displayed as patch names.

User Sample (USAM): 1–2000

Samples in user memory can be used as patches.

Card Sample (CSAM): 1–7000

Samples in the memory card can be used as patches.

- * If there are no samples in memory, this will indicate "Empty."

- * In the case of a stereo sample, choose the sample number for the L channel. It will play as a stereo patch. (If you choose the sample number for the R channel, "----" will be indicated for it, and it will not be playable.)

Saving a sample auto patch

When you edit and save these patches, they will be saved in the USER or CARD group in the same way as conventional patches.

- * Note that in this case, there will be no sound if you unload (Owner's Manual; p. 147) the sample.
- * Unsaved samples will be lost when you turn off the power. If you want to keep your sample, press [WRITE] to save it (Owner's Manual; p. 159).

Bank Select and Program Change Correspondence Chart

Group	Number	Bank Select		Program Number
		MSB	LSB	
PR-I	001-128	87	72	1-128
USAM	0001-2000	64	0	1-80
			:	
			14	
CSAM	0001-7000	65	0	1-128
			:	
			53	
			54	1-88

Newly added sample parameters

The following sample parameters have been added.

cf.

Owner's Manual; p. 150



- Sample Gain**
 This adjusts the gain of the sample, letting you boost the volume if it decreased in the process of sampling.
Value: 0, +6, +12 [dB]
 - Sample Fine Tune**
 This adjusts the pitch of the sample in steps of one cent (over a range of +/-50 cents).
Value: -50—+50
- MEMO**
 1 cent = 1/100th of a semitone
- Sample Level**
 This adjusts the volume of the sample.
Value: 1–127

Sample BPM calculator (BPM Calc)

Here's how to specify the original tempo of the sample.

- In the **Sample Prm** screen, press [F6 (BPM Calc)] to open the **BPM Calculator** window.



- Input the length (**Measure**) and time signature (**Beat**) of the sample.
- Press [F8 (EXEC)]. The tempo will be calculated, and the value will be input in the **BPM** field of the **Sample Prm** screen.

Selecting a sample (Sample Number)

Now you can switch samples in the **Sample Prm** screen as well.

You can use [F1][F2] to select samples in the order in which they appear in the sample list.

Changes in the saved sample content (Save All Samples)

cf.

Owner's Manual; p. 200

When you execute "Save All Samples," multisamples are now saved as well as all samples in sample memory.

Changes in the Patch/Rhythm Edit screen

The behavior that occurs when you press [PATCH EDIT] has changed; the screen that was formerly called the Zoom Edit screen (Owner's Manual; p. 57, p. 84) will now appear first.



In the Zoom Edit screen, you can press [F6 (Pro Edit)] to access the Patch Edit screen (or Rhythm Edit screen).



Newly added Patch Overview screen

You can now use the REALTIME CONTROL knobs to edit a patch.

• Patch Edit



• Rhythm Tone Edit



1. Press [PATCH EDIT].
2. Press [F5] several times to display the Patch Overview screen.
3. Use [F1 (↑)] or [F2 (↓)] (▲ ▼) to select the parameter group that you want to edit.
4. Use the REALTIME CONTROL knobs to edit the parameters.

MEMO

If you're editing a rhythm set, you can press a note on the keyboard to select the rhythm tone you want to edit.

Changes due to the upgraded editor software

The included “Fantom-X Editor” software has been upgraded, allowing you to use an editor program to edit samples and multisamples.

Newly added PC mode screen

In conjunction with the addition of the sample editor, a PC mode screen has been added to the Fantom-X.

When you start up the sample editor, the Fantom-X will automatically enter PC mode, and will be inoperable using its own controls. This ensures that operations on your computer and on the Fantom-X will not interfere with each other.



When you close the editor on your computer, the Fantom-X will exit PC mode and return to the normal screen.

MEMO

The Fantom-X will also enter PC mode when you execute a Write operation from the librarian (p. 54).

NOTE

When you must exit PC mode due to unavoidable circumstances, such as when your computer has frozen, you can do so by pressing [F8 (EXIT)]. A screen will ask you for confirmation. Press [F8 (OK)] to force the Fantom-X to return to the normal operation screen.

Cautions when using S-700 series sounds with the Fantom-X

The new editor adds a Fantom-X Sample Converter, which converts S-700 series patches/partial/samples into a form that can be read by the Fantom-X. When loading S-700 series files you converted using this converter from your computer via USB into the Fantom-X, please be aware of the following points.

Before you connect the Fantom-X to your computer

In order for S-700 series sound data files converted by Fantom-X Sample Converter to be loaded from your computer via USB, the Fantom-X must be in Storage mode. The power will be turned off in the course of changing System settings, so make sure that you save any unsaved data before switching to Storage mode. For details on how to make this change, refer to “Switching the USB Mode and the MIDI Mode” (p. 218) in the Owner’s Manual.

* *You don’t need to perform this operation when loading data from a card without using the USB.*

NOTE

You must switch the USB mode (Storage mode/MIDI mode) before you connect the Fantom-X to your computer.

For details on using USB Storage mode, refer to “Transferring Files to or from Your Computer (Storage Mode)” (p. 219) in the Owner’s Manual.

Importing patches and rhythm sets

Here's how patches, rhythm sets, multisamples, and samples placed in the following directory using Fantom-X Sample Converter can be imported into the Fantom-X.

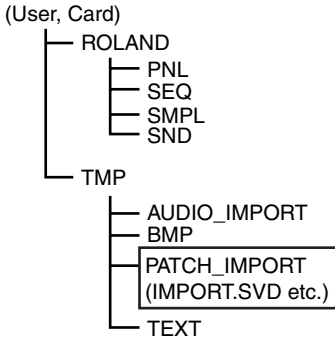

* If you used Fantom-X Sample Converter only to convert partials or samples, load them using Import Audio. (Owner's Manual; p. 220)

* If this directory does not exist, use your computer to create it.

1. Press [MENU].
2. Press ▲ or ▼ to select "Utility," and then press [ENTER].

The Utility Menu screen will appear.



3. Press [F5 (Import Patch)].

The Import Patch/Rhythm screen will appear.

* From this point onward, the screens are shown in "wizard" format to guide you through the process.

4. The screen will indicate STEP 1.

The Fantom-X will check whether there are any files that can be imported. If such files are found, the User and/or Card icons will appear.

Turn the VALUE dial or use [INC][DEC] or ▲ ▼ to choose whether you want to import from User or from Card.

* If there is no data that can be imported, these icons will not appear.

5. Press [F8 (⇒)].
6. STEPS 2–4 will appear.

Turn the VALUE dial or use [INC][DEC] or ▲ ▼ to select the starting number of the write destination for patch, multisample, and rhythm set respectively. (The user or card data will be overwritten by the imported data.)

NOTE

If you specify a high number as the starting number, the imported patches, rhythm sets, and/or multisamples may exceed their maximum numbers, making them impossible to import the remains.

NOTE

You can't change the write-destination group (User/Card). It will be the same as the loaded group.

MEMO

If there is no data to import, a screen like the following will appear.



MEMO

Sample data will be assigned automatically to numbers at the write destination.

7. Press [F8 (⇒)].

8. STEP 5 will appear.

This screen shows details about the patch being imported.



If you are satisfied with what the screen shows, press [F6 (Exec)] to begin the import.

9. A screen like the following is shown during the import.



NOTE

Never turn off the power while data is being imported.

NOTE

If some of the data being imported is missing, the error message "File Not Found" will appear. In this case, delete all of the files in the PATCH_IMPORT folder, and use Fantom-X Sample Converter to replace the data.

10. When the import is completed, you are asked whether you can delete the source files located in the User or Card PATCH_IMPORT directory.

Press [F8 (Exec)] to delete the files. (To cancel, press [F7 (Cancel)].)

* *It may take some time for files to be deleted.*

MEMO

If the Import was successful, there is normally no need to keep the source file.

11. Press [F8 (OK)] to return to the normal screen.

12. Save the sample.

Unlike patches, rhythm sets, and multisamples, samples are not saved automatically when the import procedure finishes. You must save samples as described in "Saving Samples (Save All Samples)" (Owner's Manual; p. 200).

* *In some cases, an imported patch, rhythm set, or sample may sound differently than when played back on the S-700 series.*

Fantom-X Editor System Requirements

If you're using Fantom-X Editor version 2.1 or later, please refer to the following.

System Requirements (Windows)

- **Operating System**
Microsoft® Windows® 2000 Professional
Microsoft® Windows® XP
 - **CPU/Clock:**
Pentium®/Celeron® processor 800 MHz or higher
 - **Memory (RAM)**
384 MB or more
 - **Hard Disk**
140 MB or more
 - **CD-ROM Drive**
Built-in CD-ROM drive (IDE)
 - **Display/Colors**
800 x 600 or higher/65,536 colors (16 bit High Color) or more
- * *Microsoft and Windows are registered trademarks of Microsoft Corporation.*
- * *Windows® is known officially as: "Microsoft® Windows® operating system."*
- * *Pentium is a registered trademark of Intel Corporation.*

System Requirements (Mac OS)

- **Operating System**
Mac OS X 10.2 or later
 - **CPU/Clock**
PowerPC G4 867 MHz or higher
 - **Memory (RAM)**
384 MB or more
 - **Hard Disk**
140 MB or more
 - **CD-ROM Drive**
Built-in CD-ROM drive (IDE)
 - **Display/Colors**
800 x 600 or higher/32,000 colors or more
- * *Apple and Macintosh are registered trademark of Apple Computer, Inc.*
- * *MacOS is a trademark of Apple Computer, Inc.*

About the included USB MIDI driver

The USB driver included on the CD-ROM that comes with this product can be used in MIDI mode with the following operating systems.

Operating System	MIDI Mode
Windows XP/2000 or later	√
Windows 98/98SE/Me	not supported
Mac OS X	√
Mac OS 9	not supported

- * *This may not work correctly with some types of computer.*

Other changes

Changes in the Patch Edit screen

Due to the newly added Multisample Edit screen, the following buttons in the Patch Edit screen have changed.

MEMO

The method for displaying the Patch Edit screen has changed. For details, refer to “Changes in the Patch/Rhythm Edit screen” (p. 41).

Before the update (Patch Edit screen)



After the update (Patch Edit screen)



After the update (Zoom Edit screen)



- **Newly added [F4 (Util Menu)]**

The previous [F4 (Init)] and [F5 (Tone Copy)] have been moved to a menu.

(Example)

When you have pressed [F4 (Util Menu)] to open the Patch Utility Menu window



Select the desired menu item, and press [F8 (Select)] to perform the same operation as before.

MEMO

The same applies to the Rhythm Edit screen.

Press [F4 (Util Menu)] to open the Rhythm Utility Menu. Choose the desired menu item, “Rhythm Set Initialize,” “Rhythm Key Initialize” (initialize a specific key), or “Rhythm Tone Copy,” and then press [F8 (Select)].

- **Newly added [F5 (Multisample Edit)]**

In the Patch Edit screen, [F5 (Multisample Edit)] has been added to let you jump to the Multisample Edit screen by pressing a single button.

Changes in the Performance Mixer screen

[F5]–[F8] buttons have been added to the screen that appears when you press [SHIFT] in the Performance Mixer screen.

After the update



These buttons have the following functions.

- [F5 (Loop/Locate)]
Displays the Loop/Locate window.
* For details, see p. 179 in the Owner's Manual.
- [F6 (Micro Edit)]
Displays the Microscope screen.
* For details, see p. 192 in the Owner's Manual.
- [F7 (Audio Mixer)]
Displays the Audio Track Mixer screen (p. 21).
- [F8 (Audio Edit)]
Displays the Audio Track Edit screen (p. 15).

Changes in the Performance Layer screen

[F5]–[F8] buttons have been added to the screen that appears when you press [SHIFT] in the Performance Layer screen.

After the update



These buttons have the following functions.

- [F5 (Loop/Locate)]
Displays the Loop/Locate window.
* For details, see p. 179 in the Owner's Manual.
- [F6 (Micro Edit)]
Displays the Microscope screen.
* For details, see p. 192 in the Owner's Manual.
- [F7 (Audio Mixer)]
Displays the Audio Track Mixer screen (p. 21).
- [F8 (Audio Edit)]
Displays the Audio Track Edit screen (p. 15).

Newly added Layer List window

In the Performance Layer screen, you can now press [F6 (Layer List)] to open the Layer List window and view a list of the sounds used in each part.

Changes in the Key Range window

In the Performance Layer screen, you can press [F3 (Key Range)] to open the Key Range window and make split settings in this window.

cf.

Owner's Manual; p. 102

Playing different sounds across the keyboard (Split)

1. Press [LAYER/SPLIT] to access the Layer screen.
2. Press [F3 (Key Range)].

The Key Range window will open.

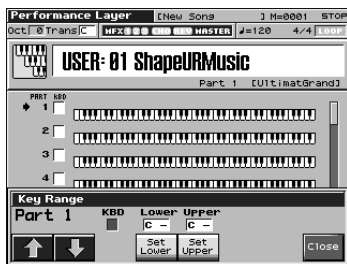

Use [F1 (↑)][F2 (↓)] to select the part you want to edit.

3. Hold down [F4 (Set Lower)] and play a note on the keyboard to specify the lowest note in the range.

Range: C-1-UPPER

4. Hold down [F5 (Set Upper)] and play a note on the keyboard to specify the highest note in the range.

Range: LOWER-C9

5. When you've finished making settings, press [F8 (Close)] to close the Key Range window.

Changes in the Song Edit screen

Due to the addition of the audio tracks, the following buttons in the Song Edit screen have changed.

Before the update



After the update

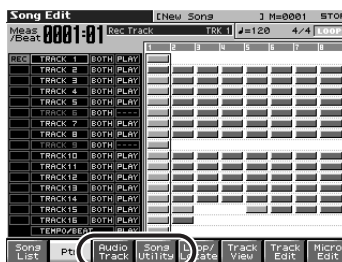

Newly added [F4 (Song Utility)]

The previous [F3 (Song Clear)] and [F4 (Song Name)] have been moved to a menu.

(Example)

When you have pressed [F4 (Song Utility)] to open the Song Utility Menu window



Select the desired menu item, and press [F8 (Select)] to perform the same operation as before.

Changes in the Song List screen

Due to the new addition of audio tracks, the contents displayed in the Song List screen have changed.

cf.

Owner's Manual; p. 177



Songs containing audio tracks are indicated by the "AUDIO" symbol.

MEMO

The "AUDIO" symbol is also shown in the Save Song screen.

When you load a song that has this symbol, the audio track data (.SVA) will also be loaded automatically (p. 26).

- * Samples will not be loaded automatically. You'll need to use a command such as Load All Samples (Owner's Manual; p. 202) to load them.

Deleting a Song

You can now delete a song from the Song List screen.

1. In the Song List screen, select the song that you want to delete, and press [F5 (Delete)].

A message will ask you for confirmation.

2. Press [F8 (Exec)] to execute.

- * If you decide to cancel, press [F7 (Cancel)].

When you delete a song from the song list, the .SVA and .SVQ files will both be deleted simultaneously.

- * If you use your computer to delete files, you must delete both the .SVA and the .SVQ files.

Using the pads for realtime erase

cf.

Owner's Manual; p. 173

While realtime-recording a song, you can now use the pads to erase data that you input from the pads.

1. Begin realtime recording (Owner's Manual; p. 170).

The Realtime Recording window will appear.



2. Press [F6 (Erase)].

The Realtime Erase window will appear.



3. Erase the unwanted data.

- [F3 (Keyboard All)]
Erase all the data for the keyboard part for as long as you hold down the button.
- [F6 (Pad All)]
Erases all the data for the pad part for as long as you hold down the button.
- To erase notes of a specific key (pad);
Hold down that key (pad).
Data for that note will be erased for as long as you hold down that key (pad).
- To erase notes of a specific key range;
Hold down the top and bottom keys of that range. Data for that range will be erased for as long as you hold down those keys.

4. Press [F8 (Close)] to close the Realtime Erase window.

You will return to the normal recording state.

CC Filter added to the Microscope

You can now specify the controller numbers that will be shown in the Microscope.

cf.

Owner's Manual; p. 194

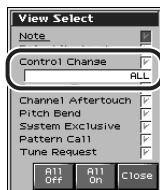

1. Access the View Select window.
2. Press ▲ or ▼ to choose “Control Change.”
3. Turn the VALUE dial or use [INC][DEC] to specify the CC numbers you want to see.

If you select “ALL,” all messages will be shown.

Improved functionality for step recording

A function that enables you to remove a previously input Tie has been added.

In the Step Rec (Note) screen, press [F6 (Untie)].

cf.

Owner's Manual; p. 174, step 7.

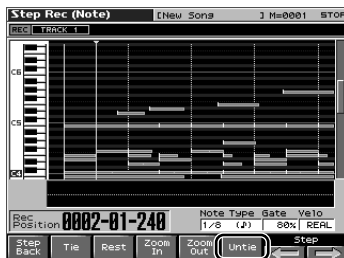

Changes in the demo song loaded when you start up the Fantom-X

cf.

Owner's Manual; p. 42

Changes to the following song:

Song name: Start Chillin'
Copyright © Roland Corporation

Improved functionality in Live Setting

cf.

Owner's Manual; p. 24

Registering a song file in a Live Setting

In addition to patches and performances, you can now register song files to a live setting.

1. Press [MENU].
2. Turn the VALUE dial or use ▲ or ▼ to select "Live Setting Edit," and then press [ENTER].

The Live Setting Edit screen will appear.



MEMO

You can also access the Live Setting Edit screen by holding down [SHIFT] and pressing [ENTER].

3. Use ▲ or ▼ ([F1 (↑)] or [F2 (↓)]) to select the bank in which you want to register the song file.
4. Use ◀ or ▶ to select the number (step) in which you want to register the song file.

You can register the song file to any of the sixteen steps. You will probably want to make your registrations in the order of the titles in your live stage set.

5. Press [F5 (Set Song)].

The Song Select screen will appear.



* By pressing ◀ or ▶ in the above screen you can specify the type of songs that will be displayed. This lets you view only the desired type of songs, making it easier to find the desired file if there are several different types of songs.

- VIEW ALL: show all songs
- SVQ ONLY: show only SVQ files
- SMF ONLY: show only Standard MIDI Files
- MRC ONLY: show only MRC files

6. Press [F1 (User)] or [F2 (Card)] to select the load destination, and press ▲ or ▼ to select the song.

If you decide to cancel, press [F7 (Cancel)].

7. Press [F8 (Select)] to register the song file.

For example, if you registered the song to number 02 of Bank 1, the screen will indicate "Regist to 1-02."

Recalling a song file you registered

You can recall a song in the same way that you recall a patch or performance. (Owner's manual p. 42)

In the Live Setting Play screen, when you recall a step for which a song has been registered, that song will be loaded.

Switching the font

Now you can switch the font of the Live Setting screen.

In the Live Setting Edit screen, repeatedly press [F4 (Font)] to switch the displayed font.

Removing the text

cf.

Owner's Manual; p. 42

Now you can delete the imported text displayed as the bank information.

1. In the Live Setting Edit screen, use ▲ or ▼ ([F1 (↑)] or [F2 (↓)]) to select the bank that you want to remove its text.
2. Hold down [SHIFT] and press [F6 (Remove Text)].

Improvements in Arpeggio functionality

When playing arpeggios, you can now use the pads to switch arpeggio styles.

Using the pads to switch arpeggio styles

cf.

Owner's Manual; p. 128

1. Hold down [SHIFT] and press [ARPEGGIO].

A screen like the following will appear.

- * If you've selected Performance mode, "Performance" is indicated at the right of "Arpeggio."



2. Press [F6 (Use Pad)].



Now you can use the pads to switch arpeggio styles.

MEMO

You can also access the above screen by pressing [PAD SETTING] to access the Pad Setting screen, and then pressing [F2 (Arp)].

Changing the arpeggio styles assigned to the pads

- In the above window, use [CURSOR] to move the cursor to “Style,” and turn the VALUE dial or use [INC][DEC] to select the desired style.



- Press [F8 (Store)].

The pads will blink.

- Press one of the pads 1–16.

Press the pad to which you want to assign the style you selected in step 1. The style will be assigned to that pad.

Improvements in Chord Memory functionality

When using chord memory, you can now use the pads to switch chord forms.

Using the pads to switch chord forms

cf.

Owner’s Manual; p. 133

- Hold down [SHIFT] and press [Chord Memory].

A screen like the following will appear.

- * If you’ve selected Performance mode, “Performance” is indicated at the right of “Chord Form.”

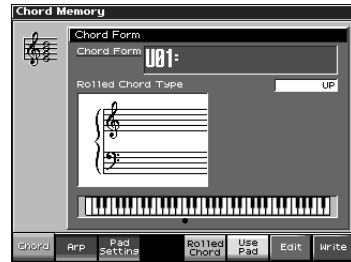

- Press [F6 (Use Pad)].



Now you can use the pads to switch chord forms.

MEMO

You can also access the above screen by pressing [PAD SETTING] to access the Pad Setting screen, and then pressing [F1 (Chord)].

Changing the chord forms assigned to the pads

1. In the above window, use [CURSOR] to move the cursor to “Chord Form,” and turn the VALUE dial or use [INC][DEC] to select the desired chord form.

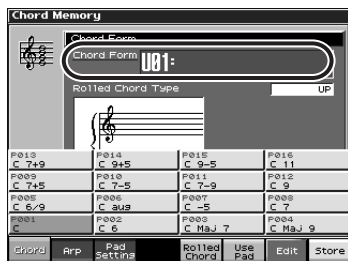

2. Press [F8 (Store)].

The pads will blink.

3. Press one of the pads 1–16.

Press the pad to which you want to assign the chord form you selected in step 1. The chord form will be assigned to that pad.

Changes in the librarian

cf.

Owner's Manual; p. 236

When using the Fantom-X librarian, you no longer need to manually select Librarian mode.

When Fantom-X Librarian begins to transmit the data, the Fantom-X will automatically enter PC mode, and will no longer respond to operations performed on its control panel. This ensures that operations on the Fantom-X will not conflict with operations on your computer.



When you close the librarian on your computer, the Fantom-X will automatically exit PC mode and return to the normal operating screen.

NOTE

When you must exit PC mode due to unavoidable circumstances, such as when your computer has frozen, you can do so by pressing [F8 (EXIT)]. A screen will ask you for confirmation, and you can press [F8 (OK)] to force the Fantom-X to return to its normal operating screen.

New shortcut from the Input Setting screen to MFX Edit

In the Input Setting screen, [F6 (MFX Edit)] has been added to let you jump to the MFX Edit screen by pressing a single button.

cf.

Owner's Manual; p. 141

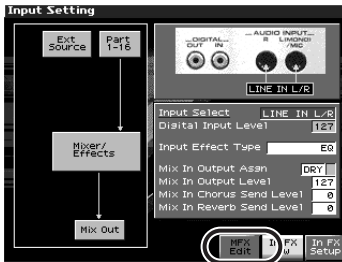

New parameters available for the assignable switches

Several more choices have been added to the functions that can be controlled by the assignable switches 1 and 2.

The newly added parameters are listed below.

cf.

Owner's Manual; p. 125

- **Master Key Shift Down**
Shifts down the System parameter Master Key Shift (Owner's Manual; p. 230) in semitone steps.
- **Master Key Shift Up**
Shifts up the System parameter Master Key Shift (Owner's Manual; p. 230) in semitone steps.
- **Scale Tune Switch**
Switches the System parameter Scale Tune Switch (Owner's Manual; p. 232)
- **CC01–CC31**
Controller numbers 1–31
- **CC33–CC95**
Controller numbers 33–95

Newly added DIMM check function

When you power up the Fantom-X, it will automatically check whether the DIMM memory (Owner's Manual; p. 242) is operating correctly.

If the DIMM contacts are faulty, a screen like the following will appear.

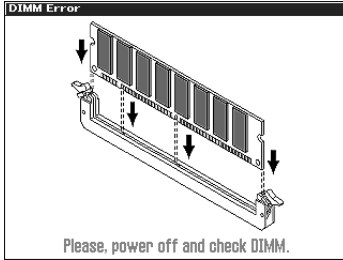

If this occurs, turn off the power immediately, and re-insert the DIMM memory correctly.

Index

- A**
Arpeggio 52
Assign
 Multisample 34
Assignable Switch 55
AUDIO MERGE 25
Audio Track 13
 Display Mode 20
 Editing 16
 Erasing 19
 Merge 25
 MIDI track 20
 Mute 16
 Naming 20
 Recording 24
 Saving 26
 Settings 22
 Zooming In / Zooming Out 20
Audio track
 Combining 18
 Erasing 19
Audio Track Edit Screen 14–16
Audio Track Mixer 1 Screen 22
Audio Track Mixer 2 Screen 23
Audio Track Mixer Screen 14, 21–22
- B**
Bank Select 39
BPM Calc
 Sample 40
- C**
Cancelling
 Skip Back Sampling 28
CC Filter
 Microscope 50
Chord Memory 53
Clear 19
Copy 18
 Multisample 35
Current Zone 36
- D**
Delete 18
Deleting
 Song 49
Demo song 50
DIMM 56
- E**
Erase
 Multisample 34
Erase All 36
 Multisample 36
Erasing
 Audio track 19
 Multisample 36
- F**
FANTOM-X Audio Track Expansion Kit 9
Fantom-X Sample Converter 42
Font
 Live Setting 52
- I**
Import Patch/Rhythm 43
Importing
 Patch 43
Input Setting Screen 55
Insert 17
- K**
Key Range Window 48
Knob
 Mixer 22
- L**
Layer List window 47
Librarian 54
Live Setting 51
Loop/Locate 17
Loop/Locate Window 17

-
- M**
- Marker
 - Viewing a List 17
 - Marker List 17
 - MXF Edit Screen 55
 - Mixdown 18
 - Audio Track 18
 - Mixer
 - Controlling 23
 - Move 16, 37
 - Multisample
 - Create Multisample Screen 31
 - Editing 33
 - List 34
 - Move 37
 - Original Key 37
 - Patch Edit Screen 31
 - Reload 36
 - Sample Select 36
 - Saving 38
 - Shift 37
 - Sort 37
 - Multisample Edit Screen 33
 - Multisample Editing 30
 - Mute
 - Audio Track 16
 - Mute/Solo 16
- O**
- Org Key
 - Multisample 37
- P**
- Patch Edit Screen 41, 46
 - Patch Group 39
 - Patch Overview Screen 41
 - PC Mode Screen 42
 - Performance Layer Screen 47
 - Performance Mixer Screen 47
 - Preview 16
 - Pro Edit 41
 - Program Change 39
- R**
- REALTIME CONTROL Knobs
 - Mixer 22
 - Realtime Erase
 - Realtime Recording 49
 - Reload
 - Multisample 36
 - Rhythm Edit Screen 41
- S**
- S-700 Series 42
 - Sample
 - BPM 40
 - Saving 39
 - Selecting 40
 - Unloading 18
 - Sample Auto Patch 39
 - Sample Event
 - Auditioning 16
 - Copying 18
 - Deleting 18
 - Inserting 17
 - Moving 16
 - Selecting 16
 - sample event 13
 - Sample Fine Tune 40
 - Sample Gain 40
 - Sample Level 40
 - Sample Number 40
 - Sample Parameter 40
 - Sample Select 36
 - Saving
 - Audio Track 26
 - Multisample 38
 - Sample Auto Patch 39
 - Shift
 - Multisample 37
 - Skip Back Sampling 27
 - Assign to Audio Track 29
 - Assign to Keyboard/Pad 28
 - Cancelling 28
 - Editing 28
 - Skip Back Cancel 28
 - Start Beat/End Beat 28

SOLO/RE-SAMPLING	24
Song	49
Song Edit Screen	48
Song File	
Live Setting	51
Song List screen	49
Sort	
Multisample	37
Split Point	35
Multisample	35
Step Recording	
UNTIE	50
T	
Tone Sw/Sel	35
Tone Switch/Select Window	35
Track Name	20
U	
Unload Sample	18
UNTIE	
Step Recording	50
Updating	9
USB MIDI driver	45
Z	
Zone	36
Zooming In / Zooming Out	20

MEMO