

 Roland®

EP-50

Owner's Manual

EP-50

Roland Electronic Piano

Features

- The EP-50 is a Roland electronic piano which offers you excellent performance abilities.
- Extremely dynamic, yet realistic expressions are obtained owing to its Velocity Sensitivity which can change the tone color (harmonic contents) as well as volume.
- All pitches, even the lower tones sound deep, lingering and articulate.
- The Key Transpose function allows transposition to any Key you like.
- This compact and light weighted electronic piano can be comfortably moved where you like.
- Provided with the IN, OUT and THRU sockets for MIDI, this piano can be connected to other MIDI instruments.

Important Notes

Location

- Operating the EP-50 near a neon or fluorescent lamp may cause noise interference. If so, change the position or angle of the piano.
- Avoid using the EP-50 in excessive heat or humidity or where it may be affected by direct sunlight or dust.

Power Supply

- The appropriate power supply for this instrument is shown on its name plate. Please be sure that the voltage system in your country meets this.
- This instrument might generate heat while operating, but here is no need to worry about it.

Cleaning

- Use a soft cloth and mild detergent for cleaning.
- Do not use solvents such as paint thinner.

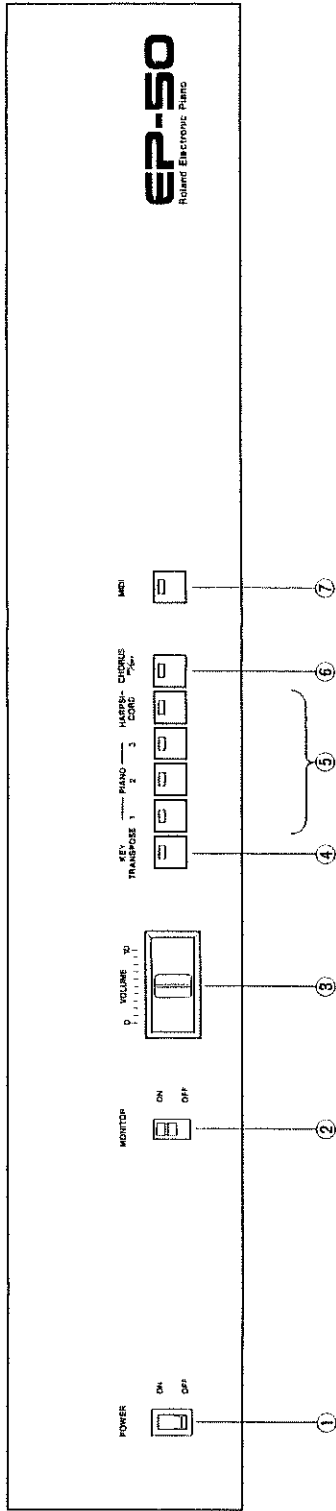

Rear Panel

- ① **MIDI THRU**
The digitally controlled signal fed into the MIDI IN Connector will be output without processed from this MIDI THRU Connector. By using this Connector it is possible to control more than one device.
- ② **MIDI OUT Connector**
Through this digitally controlled signal is sent out from the EP-50 driving the MIDI device connected.
* In the EP-50, the signal received at MIDI In will not be sent from the MIDI OUT.

- ③ **MIDI IN Connector**
By feeding digitally controlled signal of other MIDI device through this input jack, the EP-50 can be controlled externally.

- ④ **Pedal Jack (Damper)**
This jack is used to connect the supplied Pedal Switch DP-2. It will function just like a damper pedal of a usual piano.

- ⑤ **Tune Knob**
This is used to tune the EP-50 to other musical instrument. At its center position, A = 442 Hz.
* The EP-50 itself never gets out of tune, therefore tuning is not necessary.

- ⑥ **Output Jacks**
- ⑦ **External Input Jacks**
To this jack, you can connect a Rhythm Machine such as the TR-909, PB-300 or Bass Line TB-303, etc.

- ⑧ **Headphones Jack**
Standard stereo headphones can be connected. The sound from the built-in speaker stops automatically on connecting the headphones. Please adjust the volume with the Volume Knob.

- ⑨ **AC Socket**
* Make sure that the EP-50 is turned off, then connect the power cable to this AC socket.

* The selector switch (17) should usually be set to the "..." position. Just when using the PR-800 (Recorder Plus) or the PB-300 (Rhythm Plus), set it to "...".

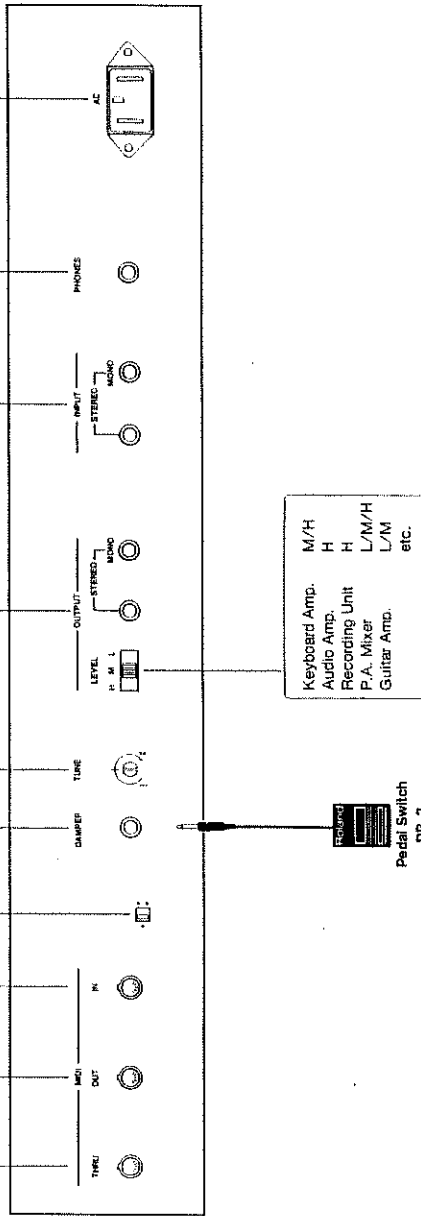

Front Panel

- ① **Power Switch**
- ② **Monitor Switch**
This switch turns on or off the speaker (and headphones). When it is off, signal is sent out only through the Line Out, and there is no sound heard from the speaker (and headphones).
- ③ **Volume Knob**
- ④ **Key Transpose Button**
Hold this button down while pressing the key (F* to F) to which you wish to transpose.

- ⑤ **Tone Selectors**
By pressing one of these buttons, you can select a tone color you like. Select just one tone color at a time.

- ⑥ **Chorus Button**
Turn this button on (the indicator lights up), then rich chorus sounds will be obtained.

- ⑦ **MIDI Button**
This button serves to select a MIDI Channel or Program Change number, etc.

■ External Connections using MIDI

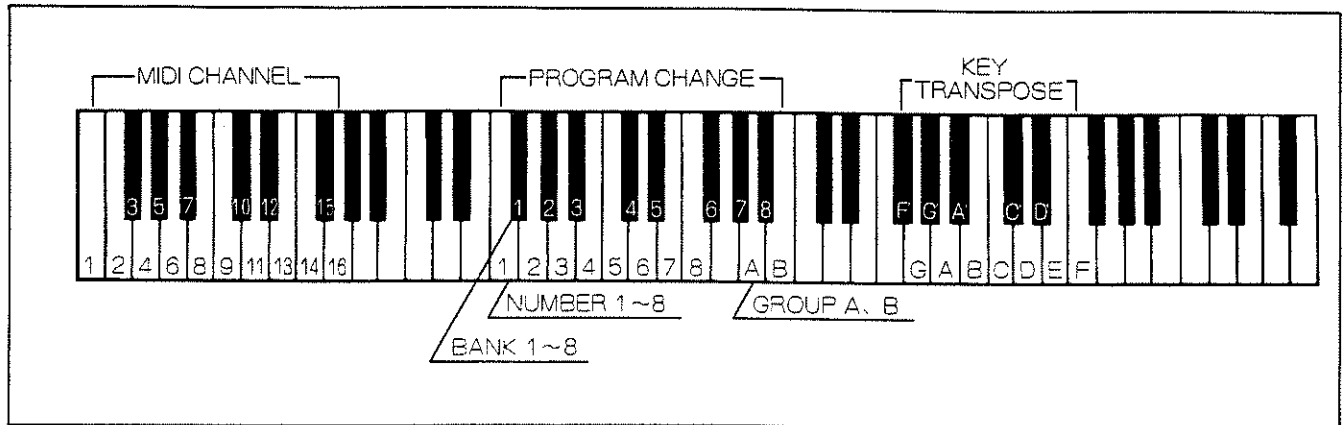

The EP-50 is the finest electronic piano on its own, but MIDI allows even more sophisticated performance by connecting other MIDI devices.

* Please read the separate book "MIDI".

The EP-50 can receive or transmit the following MIDI messages.

- Key On/Off (including Velocity)
- Channel
- Program Change
- Damper

1. Changing MIDI Channels

At power up, the EP-50 defaults to Channel 1 and OMNI ON.

→ Refer to page 8-6. Modes in the separate book "MIDI".

While holding the MIDI Button ⑦ down, press the appropriate key for the MIDI Channel (1 to 16).

* MIDI does not allow to set different channel numbers for receive and transmit. That is, the MIDI channel you have set is both for receiving and sending messages.

MIDI



While holding the button down

+

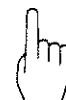
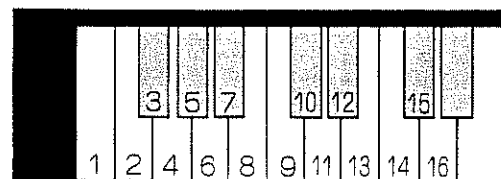

Push the Key which corresponds to the Channel number you want.

2. Program Change Message

a. Sending Program Change 0 to 127 (See page 7-4 Performance Information in "MIDI")

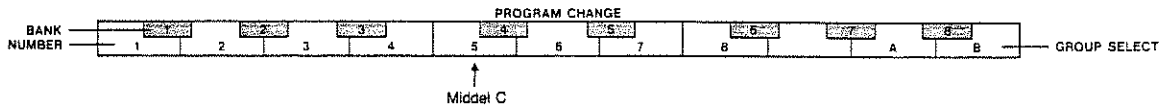

While holding the MIDI Button ⑦ down, enter the program change number you like by using the appropriate keys for Group (A or B), Bank (1 to 8) and Number (1 to 8). See the picture above and Table 1 to find the appropriate keys to be used.

For example, to send the Program Change number 100, press the Keys as shown right.

e.g.) To Send Program Change No. 100.

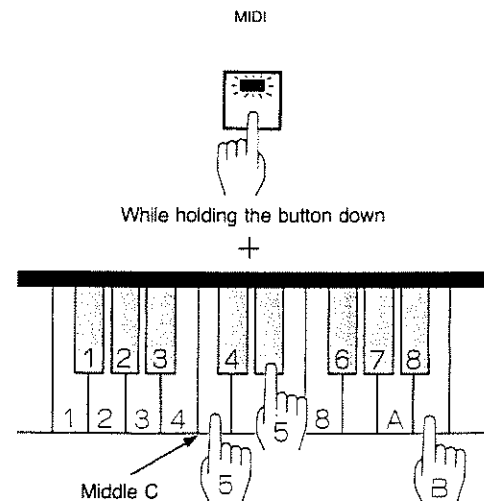

Table 1

Bank \ Number		1	2	3	4	5	6	7	8
		1	2	3	4	5	6	7	8
A	1	0	1	2	3	4	5	6	7
	2	8	9	10	11	12	13	14	15
	3	16	17	18	19	20	21	22	23
	4	24	25	26	27	28	29	30	31
	5	32	33	34	35	36	37	38	39
	6	40	41	42	43	44	45	46	47
	7	48	49	50	51	52	53	54	55
	8	56	57	58	59	60	61	62	63
B	1	64	65	66	67	68	69	70	71
	2	72	73	74	75	76	77	78	79
	3	80	81	82	83	84	85	86	87
	4	88	89	90	91	92	93	94	95
	5	96	97	98	99	100	101	102	103
	6	104	105	106	107	108	109	110	111
	7	112	113	114	115	116	117	118	119
	8	120	121	122	123	124	125	126	127

b. Receiving Program Change 0 to 7

The EP-50 can receive Program Change numbers 0 to 7. This enables to externally select any of the 8 patches (4 tone colors and 2 kinds of chorus settings).

If you do not want the EP-50 to receive Program Change message, turn the piano on while holding the button ⑦.

NOTE:

Program Change messages are not transmitted or received while any key on the keyboard is being pressed.

	Tone Color	Chorus Effect
0	Piano 1	OFF
1	Piano 2	OFF
2	Piano 3	OFF
3	Harpsichord	OFF
4	Piano 1	ON
5	Piano 2	ON
6	Piano 3	ON
7	Harpsichord	ON

* For example, when the Program Change Number 5 is received, "Piano 2" is called, and the Chorus effect is turned on.

3. Key On/Off & Damper Messages (See page 7-4 "MIDI".)

These two messages will be received without taking any special operations.

NOTE:

When the Transpose function is used, the note number sent from the MIDI OUT will be changed. That is, transposed note number (= note number of the Standard pitch) is transmitted.

NOTE:

The Transpose function does not work on the Key Information received from MIDI IN.

■ Example Connections

1) Setup with MIDI Sound Module

In this setup, both the EP-50 and the MIDI Sound Module can be simultaneously played.

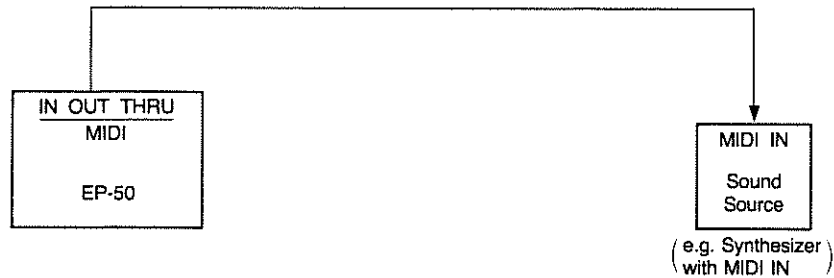

2) Controlling EP-50 by MIDI Keyboard

The EP-50 can be played by other MIDI Keyboard.

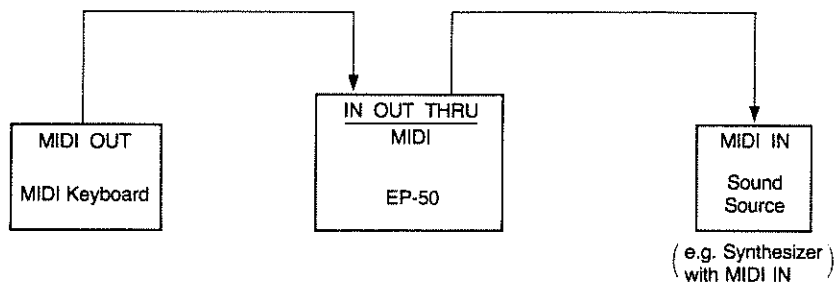

3) Setup with MIDI Keyboard Recorder

The Keyboard Recorder can record what is played on the EP-50 and play it back.

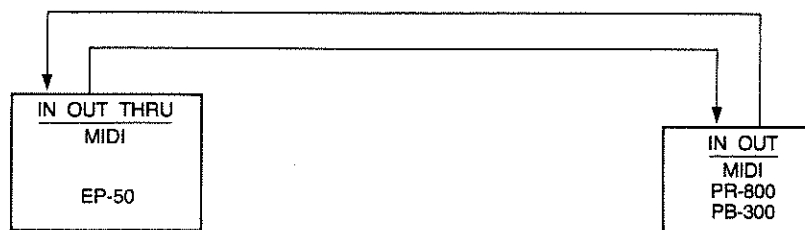

*Set the switch ⑰ to the "·" position.

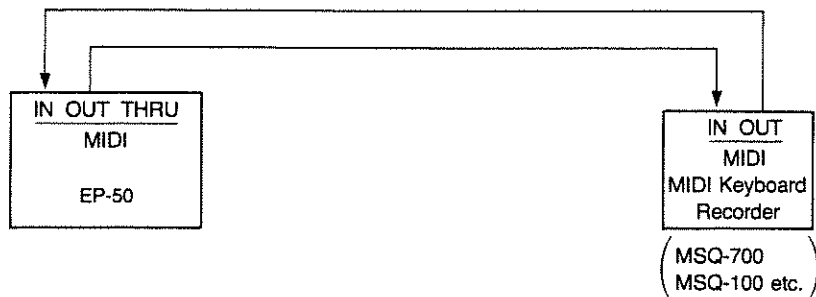

■ Key Transpose

By using the appropriate key, you can shift the pitch of the entire keyboard up to the perfect fourth upward or diminish fifth downward.

Operation

While holding the Transpose Button ④ down, press the key (F# to F) to which you wish to transpose.

While the button is being held down, the indicator flashes. When the button and the key are both released, the indicator will glow steadily showing that transposition is done.

Pressing the Transpose Button again will return the EP-50 to the normal condition (C key).

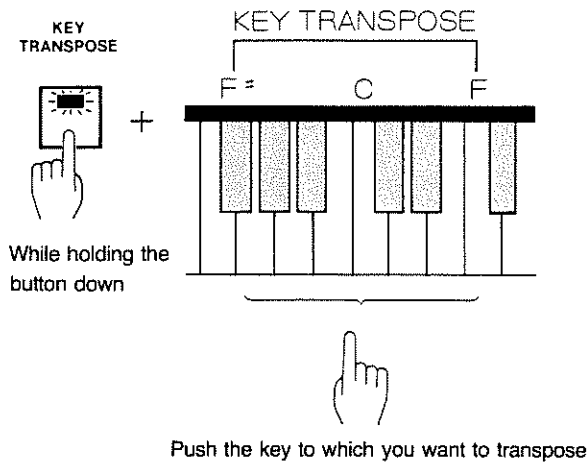

■ Specifications

Keyboard	76 keys, 8 voice polyphonic
Buttons	Piano 1, Piano 2, Piano 3, Harpsichord Transpose, MIDI
Effect	Chorus On/Off
Performance Controls	Volume Tune (± 35 cent)
Jacks	Output (Mono, Stereo), Ext. Input (Mono, Stereo), Phones, Damper Pedal, MIDI IN (DIN socket), MIDI OUT (DIN socket), MIDI THRU (DIN socket)
Switches	Output Level Selector switch Monitor Switch
Speakers	16cm x 2
Output Power	4.5W x 4.5W
Consumption	Shown on the name plate.
Dimensions	1152 (W) x 369 (D) x 104 (H) mm 45-3/8" (W) x 14-1/2" (D) x 4-1/8" (H)
Weight	15kg/33lb 2 oz
Accessories	Music Rest, Power Cord, Pedal Switch (DP-2)

*Specifications are subject to change without notice.

■ Sound Range Diagram

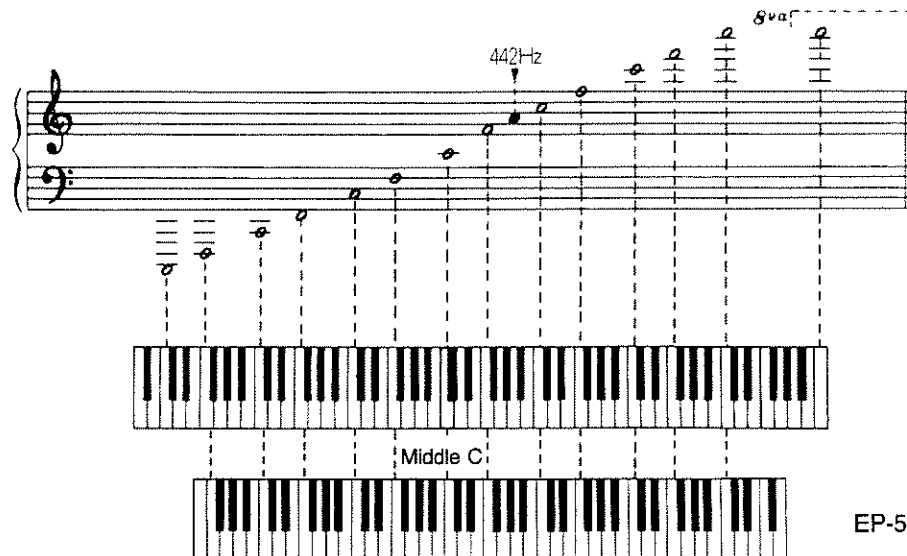

MODEL EP-50 MIDI Implementation Chart

Function.....		Transmitted	Recognized	Remarks
Basic Channel	Default Changed	1 1 - 16	1 1 - 16	
Mode	Default Messages Altered	3 POLY, OMNI OFF *****	1 POLY, OMNI ON/OFF MONO(M≠1)-1, (M=1) → 3	
Note Number	True voice	22 - 108 *****	0 - 127 21 - 108	
Velocity	Note ON Note OFF	○ × (9n v=0)	○ ×	
After Touch	Key's Ch's	× ×	× ×	
Pitch Bender		×	×	
Control Change	64	○	○	Damper pedal
Prog Change	True #	○ (0-127) *****	○ (0-7) 0 - 7	can be ignored by power-up setting
System Exclusive		×	×	
System Common	Song Pos Song Sel Tune	× × ×	× × ×	
System Real Time	Clock Commands	× ×	× ×	
Aux Messages	Local ON/OFF All Notes OFF Active Sense Reset	× ○ (123) ○ ×	× ○ (123-127) ○ ×	
Notes		When power up, ch-1 OMNI OFF and POLY are sent. When MIDI channel is changed, MODE is set at 3.		

Mode 1 : OMNI ON, POLY
Mode 3 : OMNI OFF, POLY

Mode 2 : OMNI ON, MONO
Mode 4 : OMNI OFF, MONO

○ : Yes
× : No

MODEL EP-50 MIDI Implementation

1. TRANSMITTED DATA

Status	Second	Third	Description
1001 nnnn	0kkk kkkk	0000 0000	Note OFF
1001 nnnn	0kkk kkkk	0vvv vvvv	Note ON kkkkkk = 22 - 108 *1 vvvvvv = 1 - 127
1011 nnnn	0100 0000	0111 1111	Damper ON
1011 nnnn	0100 0000	0000 0000	Damper OFF
1100 nnnn	0ppp pppp		Program Change pppppp = 0 - 127 *2
1011 nnnn	0111 1011	0000 0000	ALL NOTES OFF *3
1011 nnnn	0111 1100	0000 0000	OMNI OFF *4
1011 nnnn	0111 1111	0000 0000	POLY ON *4
1111 1110			Active Sensing

Notes :

- nnnn : MIDI channel number (0000 - 1111), ch-1 = 0000
- Refer to Section 3.
- *1 The range may change by the transposition.
- Refer to Section 4.
- *2 Refer to Section 5.
- *3 When all keys on the keyboard are released, the ALL NOTES OFF (#8n, #7B, 0) is sent.
- *4 When power is first applied, OMNI OFF and POLY ON are sent on the BASIC channel.
- When the tone is changed from the panel, and if all keys on the keyboard are not pressed, these messages are sent in the BASIC channel.

2. RECOGNIZED RECEIVE DATA

Status	Second	Third	Description
1000 nnnn	0kkk kkkk	0vvv vvvv	Note OFF, velocity ignored
1001 nnnn	0kkk kkkk	0000 0000	Note OFF kkkkkkk = 0 - 127 (21 - 108) *1
1001 nnnn	0kkk kkkk	0vvv vvvv	Note ON kkkkkkk = 0 - 127 (21 - 108) *1 vvvvvvv = 1 - 127
1011 nnnn	0100 0000	0111 1111	Damper ON
1011 nnnn	0100 0000	0000 0000	Damper OFF
1100 nnnn	0ppp pppp		Program Change pppppp = 0 - 7 *2
1011 nnnn	0111 1011	0000 0000	ALL NOTES OFF *3
1011 nnnn	0111 1100	0000 0000	OMNI OFF *4
1011 nnnn	0111 1101	0000 0000	OMNI ON *4
1011 nnnn	0111 1110	0000 0000	MONO ON *4
1011 nnnn	0111 1111	0000 0000	POLY ON *4
1111 1110			Active Sensing

Notes :

- *1 Note numbers outside of the range 21 - 108 are transposed to the nearest octave inside this range.
- The transpose function does not affect the recognized NOTE ON / OFF.
- *2 If the power is applied while the transpose switch being held down, this message may be ignored.
- The assignment of received Program Change messages is as follows:
- The program numbers 8 - 127 are ignored.

Prog #	Tone Color	CHORUS
0	PIANO 1	OFF
1	PIANO 2	OFF
2	PIANO 3	OFF
3	HARPSICHORD	OFF
4	PIANO 1	ON
5	PIANO 2	ON
6	PIANO 3	ON
7	HARPSICHORD	ON

- *3 When the ALL NOTES OFF is recognized, all the notes which have been turned ON only by MIDI IN note ON messages are turned OFF. However, if the damper pedal is pressed or the damper ON message has been recognized, these ON notes will be turned OFF until the damper pedal is released or the Damper OFF message is received.

- *4 These Mode Messages (2nd byte = 123 - 127) are also recognized as ALL NOTES OFF.

Mode Messages are recognized as follows:

: POLY ON (127)	: MONO ON (126)	: MONO ON (126)	: MONO ON (126)
: POLY	: POLY	: POLY	: POLY
OMNI OFF (124)	OMNI = OFF	OMNI = OFF	OMNI = ON
OMNI ON (125)	OMNI = ON	OMNI = ON	OMNI = ON

3. BASIC CHANNEL SETTING

When the power is first applied, the BASIC channel is normally set to 1, and the receiver's MIDI MODE is set to the MODE 1 (OMNI ON, POLY ON).

However, the basic channel may be changed when the following key on the keyboard is pressed while the MIDI switch being held down. The receiver's MIDI MODE will be set to the MODE 2 (OMNI OFF, POLY ON).

Key	BASIC channel	OMNI
Power-up	1	ON
E 1	1	OFF
F 1	2	OFF
F# 1	3	OFF
C 1	4	OFF
C# 1	5	OFF
A 1	6	OFF
A# 1	7	OFF
B 1	8	OFF
C 2	9	OFF
C# 2	10	OFF
D 2	11	OFF
D# 2	12	OFF
E 2	13	OFF
F 2	14	OFF
F# 2	15	OFF
G 2	16	OFF

4. TRANPOSE

When the power is first applied, the default transposition is set at 0. The following chart shows the relation of the key position and transposed value. (While the TRANPOSE switch being held down.)

Key	Transposed value (semi tones)	Transmitted note range
power-up	0	28 - 103
F# 5	-6	22 - 97
C 5	-5	23 - 98
C# 5	-4	24 - 99
A 5	-3	25 - 100
A# 5	-2	26 - 101
B 5	-1	27 - 102
C 6	0	28 - 103
C# 6	+1	29 - 104
D 6	+2	30 - 105
D# 6	+3	31 - 106
E 6	+4	32 - 107
F 6	+5	33 - 108

5. PROGRAM CHANGE TRANSMISSION

The following table shows the GROUP, BANK and NUMBER values related with key position which is set while the MIDI switch being held down.

Key	Related value
A 4	GROUP A
B 4	GROUP B
F# 3	BANK 1
C# 3	BANK 2
A# 3	BANK 3
C# 4	BANK 4
D# 4	BANK 5
F# 4	BANK 6
G# 4	BANK 7
A# 4	BANK 8
F 3	NUMBER 1
C 3	NUMBER 2
A 3	NUMBER 3
B 3	NUMBER 4
C 4	NUMBER 5
D 4	NUMBER 6
E 4	NUMBER 7
F 4	NUMBER 8

When one of the above-mentioned keys is pressed while the MIDI switch being held down, a PROGRAM CHANGE message will be transmitted. The transmitted program change numbers are related with the GROUP, BANK and NUMBER values as follows.

GROUP A

NUMBER	1	2	3	4	5	6	7	8
BANK								
1	0	1	2	3	4	5	6	7
2	8	9	10	11	12	13	14	15
3	16	17	18	19	20	21	22	23
4	24	25	26	27	28	29	30	31
5	32	33	34	35	36	37	38	39
6	40	41	42	43	44	45	46	47
7	48	49	50	51	52	53	54	55
8	56	57	58	59	60	61	62	63

GROUP B

NUMBER	1	2	3	4	5	6	7	8
BANK								
1	64	65	66	67	68	69	70	71
2	72	73	74	75	76	77	78	79
3	80	81	82	83	84	85	86	87
4	88	89	90	91	92	93	94	95
5	96	97	98	99	100	101	102	103
6	104	105	106	107	108	109	110	111
7	112	113	114	115	116	117	118	119
8	120	121	122	123	124	125	126	127

■ Options

- Headphones RH-10



- Pedal Switch DP-6

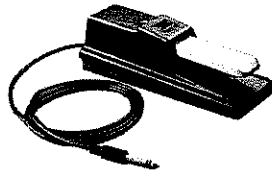

- Stand KS-100

Roland®

10517

UPC

10517



10981

Roland®