

 Roland

**MIDI INTELLIGENT SYNTHESIZER**

**E-20**

Owner's Manual

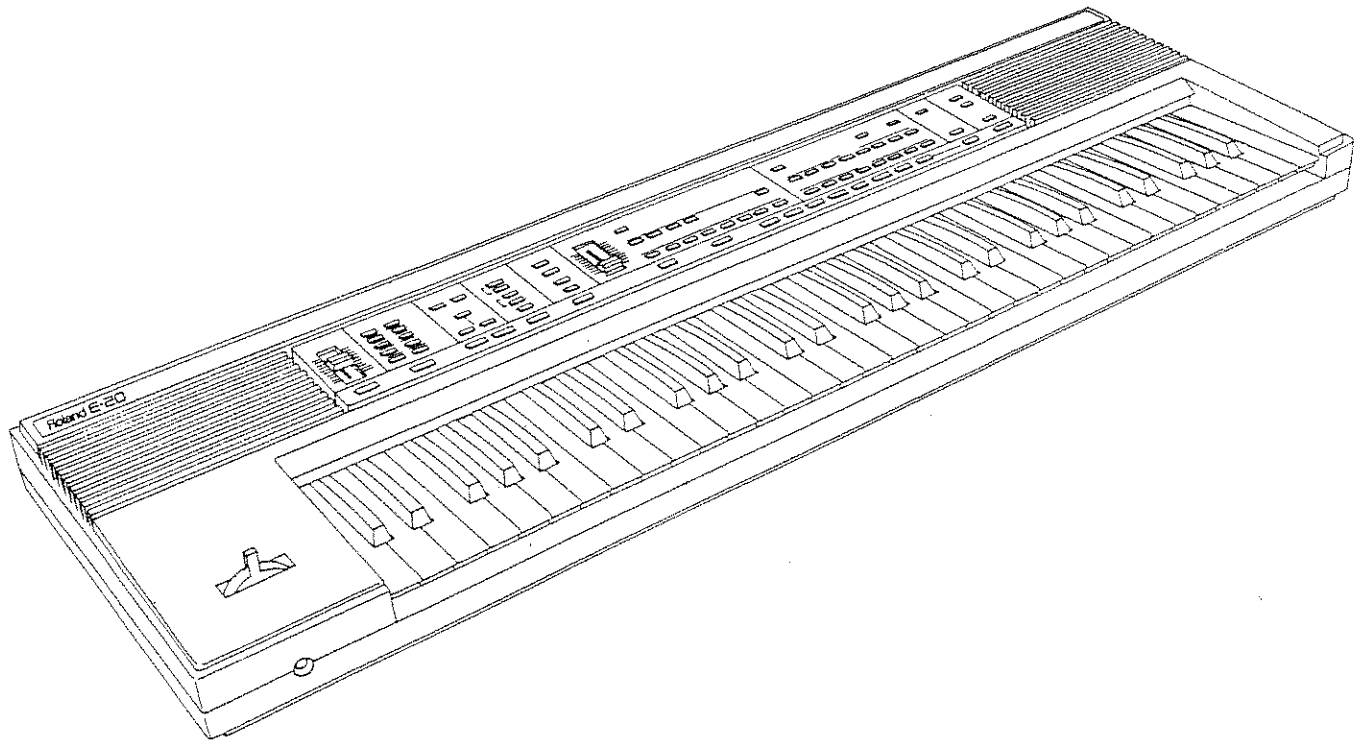

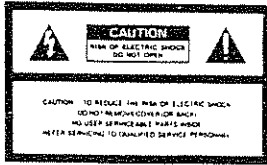

The lightning flash with arrowhead symbol, within an equilateral triangle, is intended to alert the user to the presence of un-insulated "dangerous voltage" within the product's enclosure that may be of sufficient magnitude to constitute a risk of electric shock to persons.



The exclamation point within an equilateral triangle is intended to alert the user to the presence of important operating and maintenance (servicing) instructions in the literature accompanying the product.

INSTRUCTIONS PERTAINING TO A RISK OF FIRE, ELECTRIC SHOCK OR INJURY TO PERSONS.

## IMPORTANT SAFETY INSTRUCTIONS

**WARNING** When using electric products, basic precautions should always be followed, including the following:

1. Read all the instructions before using the product.
2. To reduce the risk of injury, close supervision is necessary when a product is used near children.
3. Do not use this product near water- for example, near a bathtub, washbowl, kitchen sink, in a wet basement, or near a swimming pool, or the like.
4. This product should be used only with a cart or stand that is recommended by the manufacturer.
5. This product, either alone or in combination with an amplifier and headphones or speakers, may be capable of producing sound levels that could cause permanent hearing loss. Do not operate for a long period of time at a high volume level or at level that is uncomfortable. If you experience any hearing loss or ringing in the ears, you should consult an audiologist.
6. The product should be located so that its location or position does not interfere with its proper ventilation.
7. The product should be located away from heat sources such as radiators, heat registers or other products that produce heat.
8. The product should avoid using in where it may be affected by dust.
9. The product should be connected to a power supply only of the type described in the operating instructions or as marked on the product.

10. The power-supply cord of the product should be unplugged from the outlet when left unused for a long period of time.
11. Do not tread on the power-supply cord.
12. Do not pull the cord but hold the plug when unplugging.
13. When setting up with any other instruments, the procedure should be followed in accordance with instruction manual.
14. Care should be taken so that objects do not fall and liquids are not spilled into the enclosure through openings.
15. The product should be serviced by qualified service personnel when:
  - A. The power-supply cord or the plug has been damaged; or
  - B. Objects have fallen, or liquid has been spilled into the product; or
  - C. The product has been exposed to rain; or
  - D. The product does not appear to operate normally or exhibits a marked change in performance; or
  - E. The product has been dropped, or the enclosure damaged.
16. Do not attempt to service the product beyond that described in the user-maintenance instructions. All other servicing should be referred to qualified service personnel.

## SAVE THESE INSTRUCTIONS

### ADVARSEL!

Lithiumbatteri. Eksplosionsfare.  
Udskiftning må kun foretages af en sagkyndig,  
og som beskrevet i servicemanual.

### VARNING!

Lithiumbatteri. Explosionsrisk.  
Får endast bytas av behörig servicetekniker.  
Se instruktioner i servicemanualen.

### ADVARSEL!

Lithiumbatteri. Fare for eksplosion.  
Må bare skiftes af kvalificeret tekniker som  
beskrevet i servicemanualen.

### VAROITUS!

Lithiumparisto. Räjähöysovaara.  
Pariston saa vaihtaa ainoastaan  
aian ammattimies.

### WARNING

THIS APPARATUS MUST BE EARTH GROUNDED.

The three conductors of the mains lead attached to this apparatus are identified with color as shown in the table below, together with the matching terminal on the UK type power plug. When connecting the mains lead to a plug, be sure to connect each conductor to the correct terminal, as indicated.

**"This instruction applies to the product for United Kingdom."**

| MAINS LEADS |              | PLUG                                    |
|-------------|--------------|-----------------------------------------|
| Conductor   | Color        | Mark on the matching terminal           |
| Live        | Brown        | Red or letter L                         |
| Neutral     | Blue         | Black or letter N                       |
| Grounding   | Green-Yellow | Green, Green-Yellow, letter E or symbol |

#### Bescheinigung des Herstellers / Importeurs

Hiermit wird bescheinigt, daß der/die/das

**ROLAND SYNTHESIZER E-20**

(Serial No. Bescheinigung)

in Übereinstimmung mit den Bestimmungen der

**Amtsbl. Vfg 1046 / 1984**

(Antragstellerbezeichnung)

funk-entstört ist.

Der Deutschen Bundespost wurde das Inverkehrbringen dieses Gerätes angezeigt und die Berechtigung zur Überprüfung der Serie auf Einhaltung der Bestimmungen eingeräumt.

**Roland Corporation Osaka / Japan**

Name des Herstellers/Importeurs

#### RADIO AND TELEVISION INTERFERENCE

**Warning:** This equipment has been verified to comply with the limits for a Class B computing device pursuant to Subpart J, of Part 15 of FCC rules. Operation with non-certified or non-verified equipment is likely to result in interference to radio and TV reception.

The equipment described in this manual operates and uses radio frequency energy. If it is not installed and used properly, that is, in strict accordance with our instructions, it may cause interference with radio and television reception.

This equipment has been tested and found to comply with the limits for a Class B computing device in accordance with the specifications in Subpart J, of Part 15, of FCC Rules. These rules are designed to provide reasonable protection against such interference in a residential installation. However, there is no guarantee that interference will not occur in a particular installation. If this equipment does cause interference to radio or television reception, which can be determined by turning the equipment on and off, the user is encouraged to try the following measures:

- Disconnect other devices and their input/output cables one at a time. If the interference stops, it is caused by either the other device or its I/O cable.
- These devices usually require Roland designated shielded I/O cables. For Roland devices you can obtain the proper shielded cable from your dealer. For non-Roland devices, contact the manufacturer or dealer for assistance.
- If your equipment does cause interference to radio or television reception, you can try to restrict the installation by using one or more of the following measures:
  - Turn the TV or radio antenna until the interference stops.
  - Move the equipment to one side or the other of the TV or radio.
  - Move the equipment farther away from the TV or radio.
  - Plug the equipment into an outlet that is on a different circuit than the TV or radio. If that is phase within the equipment, it may be an outlet controlled by different type of breaker or fuses.
  - Consider installing a rooftop television antenna with copper cable lead-in between the antenna and TV.

If necessary, you should consult your dealer or an experienced radio/television technician for additional suggestions. You may find helpful the following booklet prepared by the Federal Communications Commission:

"How to Identify and Resolve Radio-TV Interference Problems"  
This booklet is available from the U.S. Government Printing Office, Washington, DC 20402. Stock No. DDA-689-00045-5.

Please read the separate volume "MIDI", before reading this owner's manual.

Copyright © 1988 by ROLAND CORPORATION

All rights reserved. No part of this publication may be reproduced in

# PANEL DESCRIPTION

TOP:

21

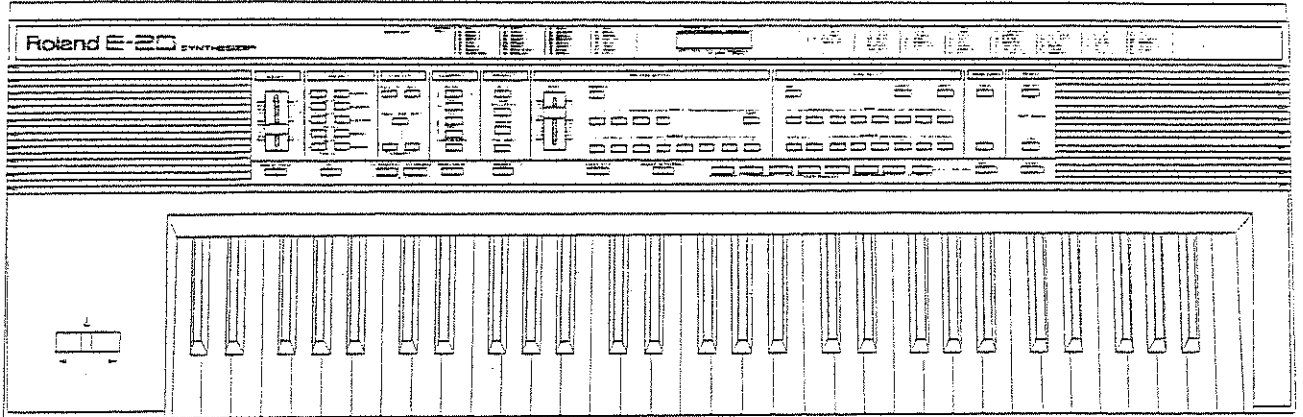

20

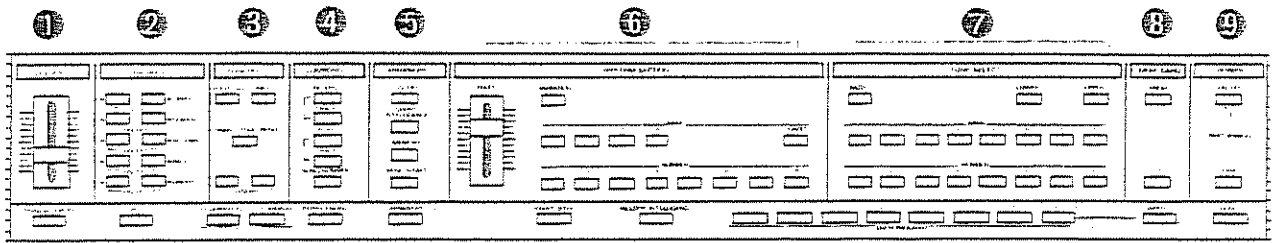

10

11

12

13

14

15

16

17

18

19

REAR:

23

27

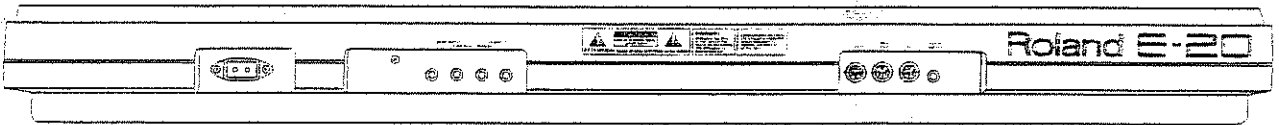

22

24

25

26

28

FRONT:

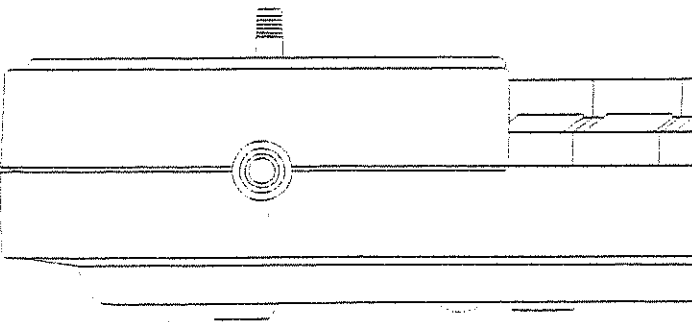

29

- ① MASTER VOLUME slider  
(See page 13)
- ② TONE BALANCE SECTION  
(See page 22)
- ③ FUNCTION CONTROL  
(See page 45)
- ④ SONG COMPOSER SECTION  
(See page 53)
- ⑤ ARRANGER SECTION  
(See page 33 in ACCOMPANIMENT)
- ⑥ RHYTHM SECTION  
(See page 25)
- ⑦ TONE SELECT SECTION  
(See page 15)
- ⑧ MEMORY CARD SECTION  
(See page 59)
- ⑨ REVERB EFFECT SECTION  
(See page 41)
- ⑩ MANUAL DRUM button  
(See page 29)
- ⑪ SPLIT button  
(See page 17 in TONE SELECT)
- ⑫ FILL-IN buttons  
(See page 34 in ACCOMPANIMENT)
- ⑬ INTRO/ENDING button  
(See page 27, 28 in RHYTHM SECTION)
- ⑭ ARRANGER 1 & 2 button  
(See page 33 in ACCOMPANIMENT)
- ⑮ START/STOP button  
(See page 27, 28 in RHYTHM SECTION)
- ⑯ MELODY INTELLIGENCE button  
(See page 39 in ACCOMPANIMENT)
- ⑰ USER PROGRAM buttons 1 — 8  
(See page 49)
- ⑱ WRITE button  
(See page 52 in USER PROGRAMS)  
(See page 60 in MEMORY CARD)
- ⑲ DEMO button  
(See Quick Reference Guide)
- ⑳ PITCH BENDER/MODULATION LEVER  
(See page 35)
- ㉑ DISPLAY WINDOW (LCD)
- ㉒ AC socket
- ㉓ POWER SWITCH
- ㉔ Stereo AUX IN sockets
- ㉕ Stereo AUX OUT sockets
- ㉖ MIDI sockets
- ㉗ MEMORY CARD Slot
- ㉘ FOOTSWITCH socket
- ㉙ Headphone socket

# FEATURES

- The E-20 is a 61 note, 32 partial, polyphonic synthesizer with dynamic keyboard.
- The E-20 uses Roland's Linear Arithmetic Synthesis (LA sound).
- The LCD (Liquid Crystal Display) provides information and directions to the player while programming the many features of the E-20 making operation quicker and easier.
- MIDI connectors are provided for connecting other MIDI devices.
- The E-20 incorporates internal speakers and amplifier of maximum output of 2 × 5 watts.

Thank you for purchasing the Roland E-20 Intelligent Synthesizer.

The E-20 is an easy-to-operate keyboard that anyone can play.

It gives you the benefit of Roland's superior digital technology.

The E-20 uses the same Linear Arithmetic synthesis used by our D-series professional synthesizers. The 64 tones and 30 percussion sounds of the E-20 offer you an excellent and natural range of sound.

The musical functions of the E-20 add the fantastic modern musical sounds of other instruments to your keyboard playing.

This Owner's Manual is written to help you have many years of musical enjoyment with your E-20.

# CONTENTS

|                                         |    |
|-----------------------------------------|----|
| <b>PANEL DESCRIPTION</b> .....          | 3  |
| <b>FEATURES</b> .....                   | 5  |
| <b>IMPORTANT NOTES</b> .....            | 8  |
| <b>THE CARE OF YOUR E-20</b> .....      | 9  |
| <b>CONNECTIONS</b> .....                | 10 |
| <br>                                    |    |
| <b>OPERATION</b>                        |    |
| <b>SETTING UP THE MUSIC STAND</b> ..... | 12 |
| <b>POWER ON</b> .....                   | 12 |
| <b>MASTER VOLUME</b> .....              | 13 |
| <br>                                    |    |
| <b>TONE SELECT</b> .....                | 15 |
| <b>UPPER TONE SELECT</b> .....          | 15 |
| <b>SPLIT</b> .....                      | 17 |
| <b>LOWER TONE SELECT</b> .....          | 19 |
| <b>BASS TONE SELECT</b> .....           | 20 |
| <br>                                    |    |
| <b>TONE BALANCE</b> .....               | 22 |
| <b>UPPER BALANCE</b> .....              | 22 |
| <b>LOWER BALANCE</b> .....              | 23 |
| <b>BASS BALANCE</b> .....               | 24 |
| <br>                                    |    |
| <b>RHYTHM SECTION</b> .....             | 25 |
| <b>RHYTHM SELECT</b> .....              | 25 |
| <b>STARTING THE RHYTHM</b> .....        | 27 |
| <b>TEMPO CONTROL</b> .....              | 27 |
| <b>STOPPING THE RHYTHM</b> .....        | 28 |
| <b>MANUAL DRUMS</b> .....               | 29 |
| <b>DRUM BALANCE</b> .....               | 32 |
| <br>                                    |    |
| <b>ACCOMPANIMENT</b> .....              | 33 |
| <b>ARRANGER ON/OFF</b> .....            | 33 |
| <b>ARRANGER 1&amp;2</b> .....           | 33 |
| <b>VARIATION</b> .....                  | 33 |
| <b>FILL-IN</b> .....                    | 34 |
| <b>MEMORY</b> .....                     | 34 |
| <b>SYNC START</b> .....                 | 34 |
| <b>PITCH BEND/MODULATION</b> .....      | 35 |
| <b>CHORD INTELLIGENCE</b> .....         | 36 |
| <b>PLAY INTELLIGENT CHORDS</b> .....    | 37 |
| <b>MELODY INTELLIGENCE</b> .....        | 39 |
| <b>ACCOMPANIMENT BALANCE</b> .....      | 40 |
| <br>                                    |    |
| <b>REVERB EFFECT</b> .....              | 41 |
| <b>REVERB PART ASSIGN</b> .....         | 42 |
| <b>REVERB TYPE</b> .....                | 44 |

|                                                             |    |
|-------------------------------------------------------------|----|
| <b>FUNCTION</b>                                             |    |
| TRANS/TUNE/BEND .....                                       | 45 |
| TRANSPOSE .....                                             | 45 |
| MASTER TUNE .....                                           | 46 |
| PITCH BENDER RANGE .....                                    | 47 |
| <br>                                                        |    |
| FOOTSWITCH ASSIGN .....                                     | 48 |
| <br>                                                        |    |
| USER PROGRAMS .....                                         | 49 |
| WRITING A PANEL CONFIGURATION .....                         | 52 |
| <br>                                                        |    |
| SONG COMPOSER .....                                         | 53 |
| RECORDING A SONG .....                                      | 54 |
| PLAYING BACK A SONG .....                                   | 58 |
| <br>                                                        |    |
| MEMORY CARD .....                                           | 59 |
| WRITING SONG COMPOSER SONGS ONTO CARD .....                 | 60 |
| LOADING THE SONGS INTO THE E-20 .....                       | 61 |
| WRITING USER PROGRAMS ONTO CARD .....                       | 62 |
| LOADING USER PROGRAMS INTO THE E-20 .....                   | 63 |
| WRITING BOTH SONGS AND USER PROGRAMS ONTO<br>CARD .....     | 64 |
| LOADING BOTH SONGS AND USER PROGRAMS INTO<br>THE E-20 ..... | 65 |
| ERROR MESSAGES .....                                        | 66 |
| <br>                                                        |    |
| STYLE CARD .....                                            | 67 |
| PLAYING RHYTHMS FROM THE CARD .....                         | 67 |
| ERROR MESSAGES .....                                        | 68 |
| <br>                                                        |    |
| MIDI CONTROL .....                                          | 69 |
| CONNECTIONS .....                                           | 69 |
| 128 TONES AVAILABLE BY EXTERNAL MIDI                        |    |
| PROGRAM CHANGE .....                                        | 71 |
| CHANGING MIDI CHANNELS AND FUNCTIONS .....                  | 72 |
| <br>                                                        |    |
| <b>IF YOUR E-20 FAILS TO OPERATE</b> .....                  | 74 |
| <b>MIDI IMPLEMENTATION CHART</b> .....                      | 75 |
| <b>SPECIFICATIONS</b> .....                                 | 76 |
| <b>PANEL SETTING MEMO</b> .....                             | 78 |

# IMPORTANT NOTES

- The appropriate power supply for the keyboard unit is shown on its name plate. Please make sure that the line voltage in your country meets the requirement.
- Use only the AC cord provided.
- Please do not use the same socket used for any noise generating device (such as a motor, variable lighting system).
- It is normal for this unit to become hot while being operated.
- If the unit is not to be used for a long period of time, unplug the AC cord from the socket.
- Disconnect the AC cord immediately in the event of an electrical storm.
- Before setting up this keyboard with other MIDI devices, turn this keyboard off along with all other units.
- Be sure to connect the MIDI cables securely. If the MIDI cable is disconnected while the keyboard is being played, various troubles will occur (e.g. the note may continue to sound).
- Static electricity may cause the built-in computer to malfunction. Should this occur, simply reset the keyboard by turning the power switch off and then after a few seconds, back on.
- This keyboard might not operate correctly if turned on immediately after being turned off. If this happens, simply turn it off and a few seconds later, turn it on again.
- Operating the E-20 near a neon light, fluorescent lamp, TV or CRT display, may cause noise interference. If so, change the position of the keyboard.
- To avoid risk of electric shock, do not perform any servicing. Refer all servicing to qualified service personnel.



# THE CARE OF YOUR E-20

To ensure the best use and full enjoyment of your E-20, please read this guide carefully and thoroughly.

## ROOM LOCATION

Avoid using this keyboard in excessive heat or humidity or where it may be affected by direct sunlight or dust and avoid places subject to strong vibrations.

## CABINET CARE

Use a soft dry cloth for dusting. To remove fingerprints or dulling film, use a soft cloth slightly dampened with water and a little mild detergent. Immediately wipe dry with a soft cloth. Do not use solvents such as paint thinners.

# CONNECTIONS

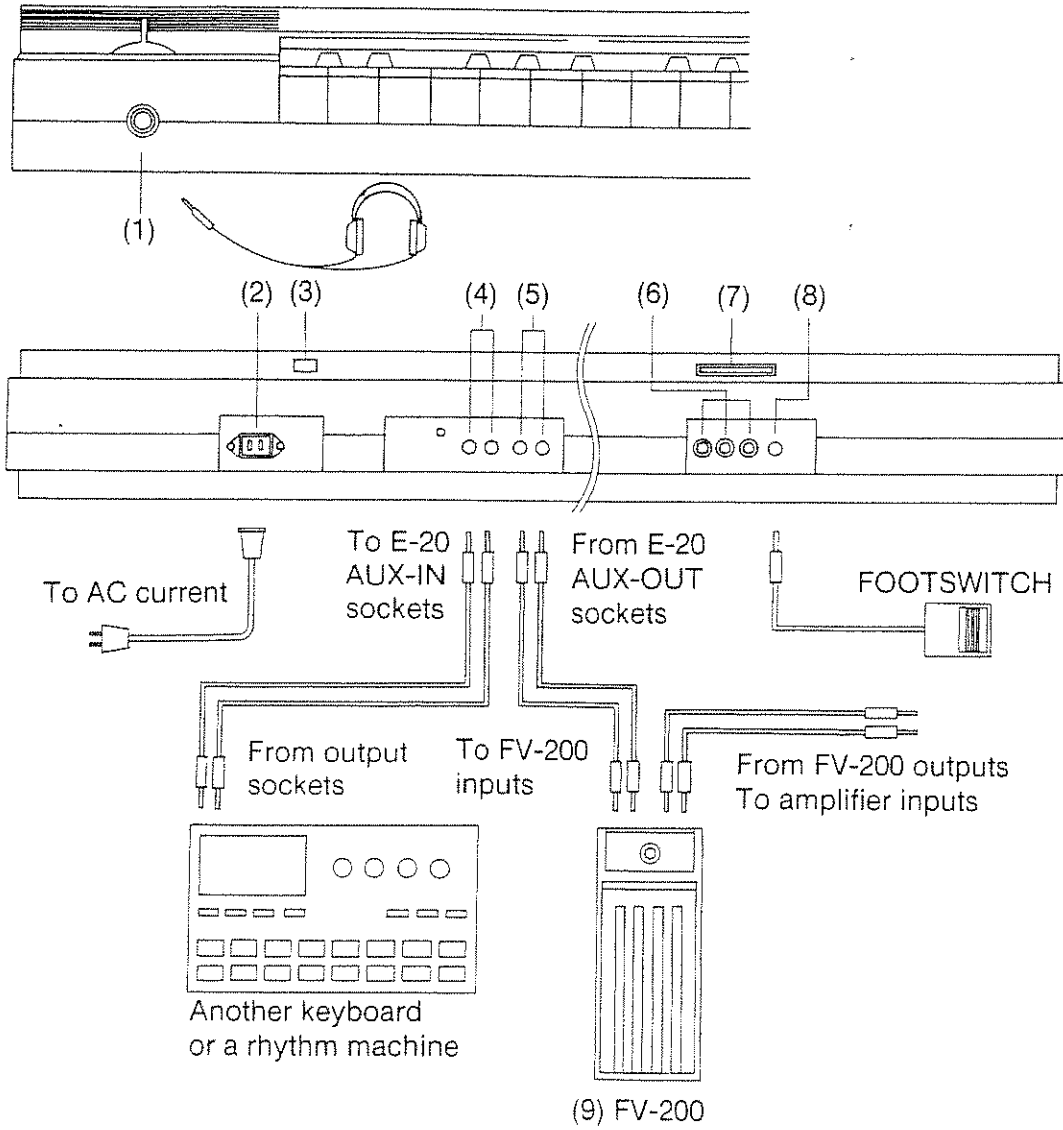

- (1) Headphones (PHONES) Socket  
For your playing convenience, connect a set of standard stereo headphones (RH-12/RH-100) into this socket and you can play and practice in private. Internal speakers will not sound when the headphone plug is connected into this socket.  
The MASTER VOLUME slider will adjust the headphones overall volume.
- (2) AC Socket  
To connect with household AC current, use the AC power cord supplied with your E-20.
- (3) POWER Switch
- (4) Stereo AUX IN Sockets  
By connecting another keyboard or a rhythm machine, the E-20 internal speakers can output all the sounds of both machines. When connecting a Mono instrument to the E-20 always use the L "(mono)" AUX IN socket.
- (5) Stereo AUX OUT Sockets  
The E-20 can be connected to external amplification (Hi-Fi, tape recorder, etc.), to further amplify the sound.  
When connecting to a Mono amplifier, always use the "R (mono)" AUX OUT socket.
- (6) MIDI Sockets  
See MIDI CONTROL.
- (7) Memory Card Slot  
Insert optional Memory Card or Rhythm Card here.  
See MEMORY CARD and STYLE CARD.
- (8) FOOTSWITCH Socket  
Using the optional footswitch (DP-2/DP-6), various functions can be controlled by foot.  
See FOOTSWITCH ASSIGN.
- (9) FV-200 Stereo Expression Pedal  
See page 14 for details.

# OPERATION

## SETTING UP THE MUSIC STAND

Supplied with your E-20 is a music stand. This will be found in the keyboard carton. To attach to keyboard, insert the two feet into the two holes located on the top panel.

## POWER ON

Press the Power On/Off switch (23).

The DISPLAY WINDOW (21) will respond with:

This is shown for a few seconds.

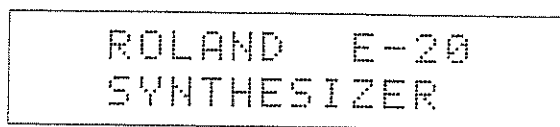

After a few seconds the display will change to:

Rhythm number and name

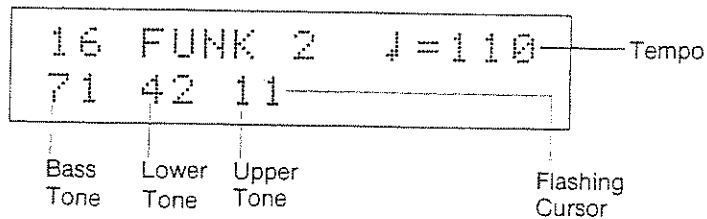

Throughout this text, this will be referred to as the Master Display.

## MASTER VOLUME

The keyboard can now be played in the Full Keyboard mode using the pre-selected 11 ELEC PIANO1 tone. Make sure that the MASTER VOLUME Slider ① is turned to the central position.

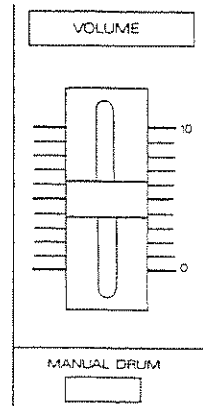

MASTER VOLUME CONTROL

The Master Volume slider control enables the overall volume of the E-20 to be raised (moving the slider away from you) or lowered (moving the slider toward you). This control will also control the overall volume when using headphones.

When connecting to external amplification, an optional stereo expression pedal (FV-200) can be used to control the overall volume. See following illustration for connecting procedures.

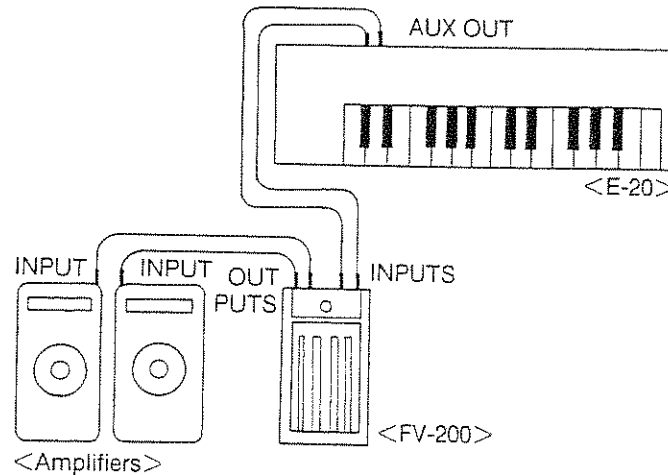

1. Be sure to turn the E-20 and any other amplification system off.
2. Connect the E-20 to the FV-200 by inserting a couple of shielded cords into the E-20 AUX OUT and the FV-200 INPUT sockets.
3. Connect the FV-200 to an amplification system with two additional shielded cords inserted into the FV-200 OUTPUT sockets.
4. Turn the switches of all instruments On and adjust the Master Volume control of the E-20.
5. Make sure that the overall volume is controlled by the foot pedal.

# TONE SELECT

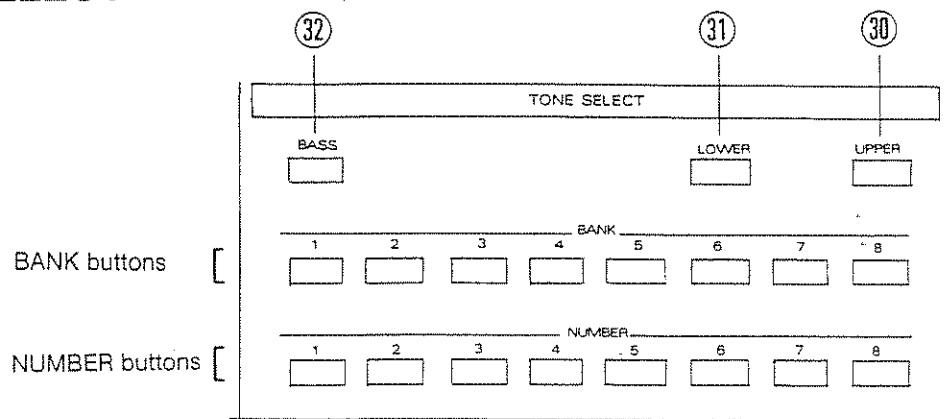

Any of the 64 different tone colors can be selected by using the BANK and NUMBER Buttons.

## UPPER TONE SELECT

To change the tone in the full keyboard mode press the UPPER button 30 in the TONE SELECT section. The display will respond with:

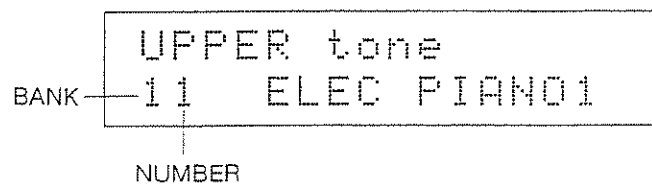

To select any of the 64 tones, press a BANK button for the first digit and then a NUMBER button for the second.

**Example:** To select 42 STRING SECT2 tone

Press BANK button 4 and then NUMBER button 2. The display will respond with:

```
UPPER tone
42  STRING SECT2
```

After a few seconds the display will revert to the Master Display.

All of the 61 keys can be played dynamically, that is the harder you play the key the louder the tone will sound.

\* The above procedure (pressing BANK and NUMBER buttons) can be carried out in any order you wish.

\* After pressing the UPPER button, the display will continue to show the UPPER tone condition until a selection using the BANK or NUMBER buttons is made.

\* If the cursor (flashing box) in the display is positioned at the UPPER tone number, there is no need to press the UPPER button before pressing BANK and NUMBER buttons, simply press the two numbers of the UPPER tone you require.



## SPLIT

The keyboard can also be played in a "Split" mode. One tone on the right-hand side of the keyboard and a different tone for the left. To 'split' the keyboard press the SPLIT button (11) . SPLIT 1 (left) LED lights.

The keyboard will now be split between the F# and G keys in the second octave. The tone now sounding from the bottom note to and including F# will be known as the "Lower" and tones for this section are selected using the LOWER button in the TONE SELECT section (see LOWER TONE SELECT). The tone now sounding from and including the G key upwards is selected using the UPPER tone button (see UPPER TONE SELECT).

Pressing the SPLIT button once more will light the LED on the right-hand side of the button. This operation moves the keyboard "Split" and expands the amount of notes available for the LOWER keyboard section. Now the notes from the bottom to and including B in the second octave will be the "Lower" keyboard and notes from and including C in the third octave will be the "Upper" keyboard.

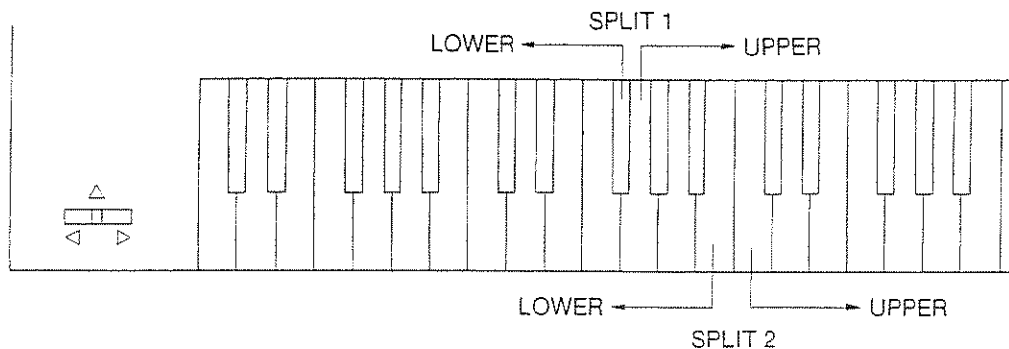

To cancel the "Split" feature and play the E-20 in the Full Keyboard mode, press the SPLIT button a third time (LEDs not lit).

The "Split" feature can also be turned Off and On by using the optional Footswitch (see FOOTSWITCH).

The SPLIT 2 function will also be automatically selected (if in Off position) when the following buttons are pressed:

- ARRANGER 1 & 2
- CHORD INTELLIGENCE
- MELODY INTELLIGENCE
- MEMORY
- (FOOTSWITCH — SPLIT On/Off)
- COMPOSER RECORD
- COMPOSER PLAY
- USER PROGRAMS 1 — 8\*

\* If any of the following functions have been programmed in the On position:

SPLIT 1 or 2

ARRANGER 1 or 2

CHORD INTELLIGENCE

MELODY INTELLIGENCE

MEMORY

When in SPLIT position (1 or 2), playing a chord in the Lower section will produce the chord sound plus a bass tone. The bass note heard, will be the root note of the chord played. To select a tone for the bass, press the BASS button in the TONE SELECT section (see BASS TONE SELECT).

Chords can be played in two different ways — Easy chords (see CHORD INTELLIGENCE) and conventional chords.

To select a different tone for the left-side of the SPLIT (Lower), press the LOWER button (31) in the TONE SELECT section. The display will respond with:

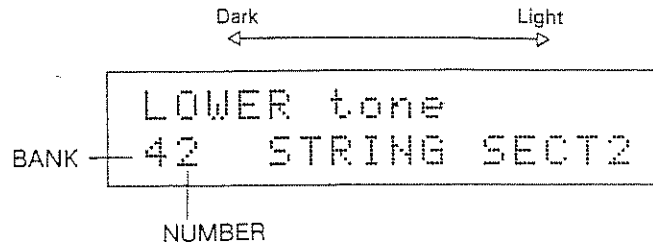

To select any of the 64 tones, press a BANK number button for the first digit and then a NUMBER button for the second.

**Example:** To select 51 FANTASY tone

Press BANK button 5 and then NUMBER button 1. The display will respond with:

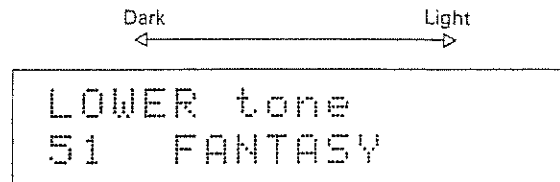

After a few seconds the display will revert to the Master Display.

\* The above procedure (pressing BANK and NUMBER buttons) can be carried out in any order you wish.

\* After pressing the LOWER tone button, the display will continue to show the LOWER tone condition until a selection using the BANK or NUMBER buttons is made.

\* If the cursor (flashing box) in the display is positioned at the LOWER tone number, there is no need to press the LOWER button before pressing BANK and NUMBER buttons, simply press the two numbers of the LOWER tone you require.

## BASS TONE SELECT

To change the Bass tone, press the BASS button (32) in the TONE SELECT section. The display will respond with:

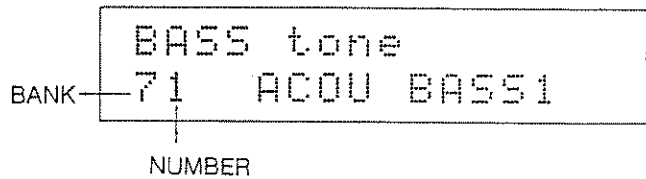

To select any of the 64 tones, press a BANK number button for the first digit and then a NUMBER button for the second.

**Example:** To select 74 SLAP BASS 1 tone

Press BANK button 7 and then NUMBER button 4. The display will respond with:

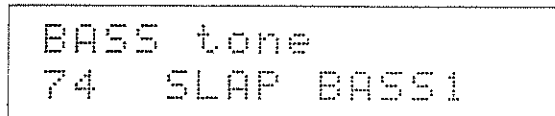

After a few seconds the display will revert to the Master Display.

\* The above procedure (pressing BANK and NUMBER buttons) can be carried out in any order you wish.

\* After pressing the BASS tone button, the display will continue to show the BASS tone condition until a selection using the BANK or NUMBER buttons is made.

\* If the cursor (flashing box) in the display is positioned at the BASS tone number, there is no need to press the BASS button before pressing BANK and NUMBER buttons, simply press the two numbers of the BASS tone you require.

## <Notes on Tone Selecting>

- \* On selecting either UPPER, LOWER or BASS tones, if the BANK or the NUMBER is the same as the previous tone, there is no need to press that button.
- \* The UPPER and BASS tone select procedures are the same with or without the Rhythm playing.
- \* While the ARRANGER is playing, the LOWER tone will not sound, and changing the LOWER tone or modifying the Lower volume (LOWER BALANCE: see TONE BALANCE) will not make any effect at all.
- \* Changing the BASS tone will not affect the preset BASS tone played by ARRANGER 1&2.  
The Master Display will always revert to indicate the preset BASS tone when ARRANGER is playing.

# TONE BALANCE

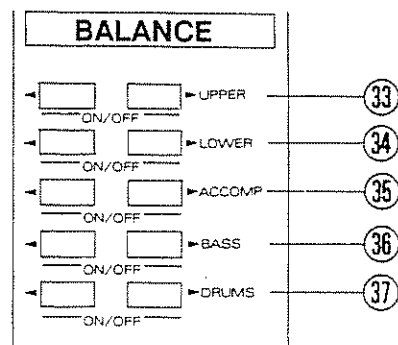

The volumes of UPPER, LOWER and BASS tones can be controlled by the buttons “>” and “<” in the BALANCE section.

## UPPER BALANCE

To adjust the volume of the UPPER tone (or Full Keyboard tone when SPLIT is Off), press either UPPER “>” button to increase or “<” button to decrease the volume (33). The display will respond with:

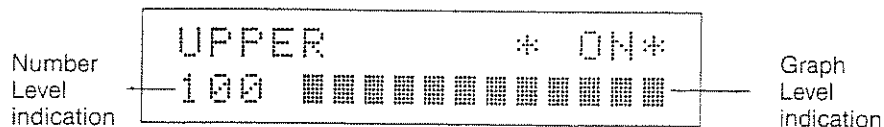

Pressing either UPPER “>” or “<” buttons will cause the number and graph indication to increase or decrease.

\* After a few seconds if neither button is pressed, the display will return to the Master Display.

To quickly turn off the UPPER tone, press UPPER “>” and “<” buttons simultaneously. The display will respond with:

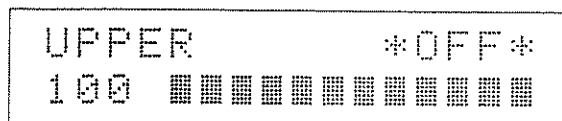

To turn the UPPER tone on again, press UPPER “>” and “<” buttons again simultaneously.

## LOWER BALANCE

To adjust the volume of the LOWER tone, press either LOWER "▷" button to increase or "◁" button to decrease the volume (34). The display will respond with:

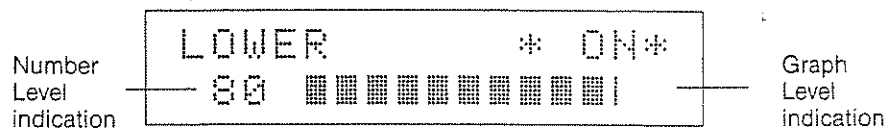

Pressing either LOWER "▷" or "◁" buttons will cause the number and graph indication to increase or decrease.

\* After a few seconds if neither button is pressed, the display will return to the Master Display.

To quickly turn off the LOWER tone, press LOWER "▷" and "◁" buttons simultaneously. The display will respond with:

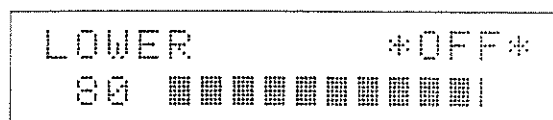

To turn the LOWER tone on again, press LOWER "▷" and "◁" buttons again simultaneously.

## BASS BALANCE

To adjust the volume of the BASS tone, press either BASS "▷" button to increase or "◁" button to decrease the volume (36). The display will respond with:

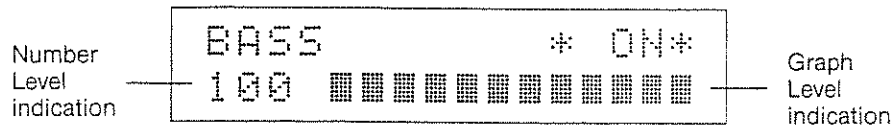

Pressing either BASS "▷" or "◁" buttons will cause the number and bar graph indication to increase or decrease.

\* After a few seconds if neither button is pressed, the display will return to the Master Display.

To quickly turn off the BASS tone, press BASS "▷" and "◁" buttons simultaneously. The display will respond with:



To turn the BASS tone on again, press BASS "▷" and "◁" buttons again simultaneously.



# RHYTHM SECTION

Your E-20 is also equipped with a built-in automatic rhythm section.

Each rhythm includes a Drum track, Bass line and Orchestral accompaniment and preset tempo. You can select between the basic rhythm (original) and Variation (see VARIATION). The ARRANGER supplies the Orchestral Accompaniment with a choice of simple or complex arrangements (see ARRANGER 1&2 in ACCOMPANIMENT). MEMORY automatically holds the notes you play until new notes are played (see MEMORY in ACCOMPANIMENT).

## RHYTHM SELECT

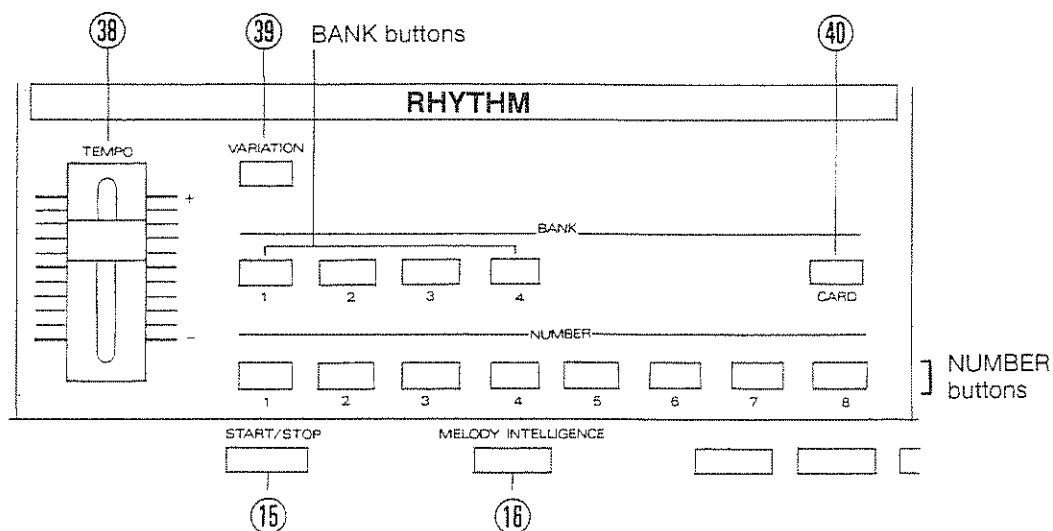

The instrument will automatically select 16 FUNK 2 when it is turned on. To select a different rhythm from the 32 in the RHYTHM TABLE, press in the rhythm section a BANK button for the first digit and a NUMBER button for the second. The display will indicate the new rhythm selected.

**Example:** To select 44 CHA CHA rhythm

Press BANK button 4 and then NUMBER button 4. The display will respond with the new rhythm and preset tempo:

|    |     |     |       |
|----|-----|-----|-------|
| 44 | CHA | CHA | J=140 |
| 71 | 42  | 11  |       |

- \* The above procedure (pressing BANK and NUMBER buttons) can be carried out in any order you wish.
- \* On selecting a new rhythm, if the BANK or the NUMBER is the same as the previous rhythm, there is no need to press that button.
- \* A new rhythm can be selected while the rhythm is playing. In this operation, the new rhythm will not play at the preset tempo, but the tempo of the previous rhythm.
- \* Additional Rhythms can be obtained from optional Style Cards available from your Roland dealer. To load and select the additional rhythms, see STYLE CARD.

## VARIATION

Pressing the VARIATION button  (see RHYTHM SECTION) will give a variation to the rhythm (LED lights).

To return to the basic (original) rhythm, press the VARIATION button once more (LED will be turned off).

## STARTING THE RHYTHM

The rhythm can be started in three ways:

1. Press the START/STOP button (15) and the rhythm will start immediately.
2. Press the SYNC START button (44) (see ACCOMPANIMENT) (LED lights). Then press a key in the accompaniment section of the keyboard. The rhythm will automatically start (LED is turned off).

\* The Sync Start function may only be selected when the rhythm is stopped.

3. Press the INTRO/ENDING button (13) . The rhythm will begin with a musical "introduction", the length of which depends on the rhythm selected.

While the rhythm is playing, the START/STOP LED will flash in time with the tempo set, the downbeat (first beat) of the measure will flash longer. When the rhythm is stopped, the LED will just flash the beat of the tempo set.

## TEMPO CONTROL

To change the tempo, move the TEMPO slider control (38) located in the RHYTHM SECTION to the rhythm's preset point and then away from you to increase the tempo or towards you to decrease the tempo. The numbers at the top-right of the display will indicate the tempo in BPM (beats per minute).

**Example:** ♩ = 140. This means that 140 quarter notes (crotchets) will be played within one minute.

The TEMPO range is from a minimum of 32 to a maximum of 250.

## STOPPING THE RHYTHM

The rhythm can be stopped in two ways:

1. Press the START/STOP button and the rhythm will stop immediately.
  2. Press the INTRO/ENDING button. At the next downbeat the rhythm will perform a musical "ending", the length of which depends on the rhythm selected.
- \* You can change from one rhythm to another WITHOUT stopping the rhythm by simply pressing the appropriate BANK and NUMBER buttons in the RHYTHM section. With this operation, the new rhythm will not be played at the rhythm's preset tempo, but will follow the tempo set by the previous rhythm.

While stopped or while playing, the volumes of each section of the rhythm (DRUM, BASS, ACCOMP and UPPER) can be modified by using the appropriate "▷" and "◁" buttons in the BALANCE section.

## MANUAL DRUMS

Pressing the MANUAL DRUM button **(10)** (LED lights) enables all the 30 drum instruments to be played manually from the keyboard. All the drum instruments can be played dynamically, that is the harder you play any key the louder the drum will sound.

Underneath, at the front section of the keyboard, you will find the names of each instrument the key represents. Each of these instruments can be played without or in conjunction with the automatic rhythm. When the MANUAL DRUM button is pressed without using automatic rhythm, the keyboard from the lowest note to D# in the 4th octave (MIDI note #75) will not play any musical note. A manual rhythm can then be played using these keys. When using automatic rhythm and ARRANGER, pressing the switch will cancel any automatic chords and bass. The keys can then be used to manually add drum voices to the automatic rhythm playing. If the MEMORY button was pressed (LED lit) prior to pressing the MANUAL DRUM button, the chord playing will remain and cannot be changed until the MANUAL DRUM button is pressed once more (LED off).

While the rhythm is stopped or playing, upper note tones can still be played from E in the 4th octave upwards when the MANUAL DRUM button is pressed.

To cancel the manual drums, simply press the MANUAL DRUM button one more time (LED off).

The assignment of the drum sounds are shown in the following illustration. The number represents the MIDI note number.

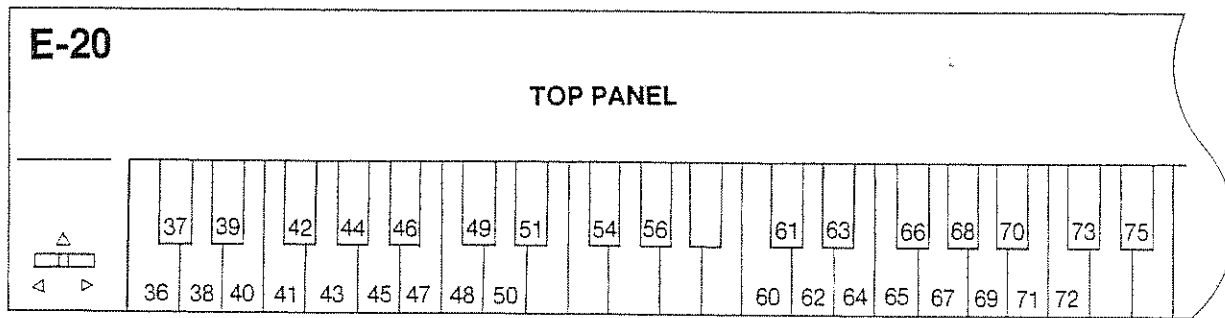

- |                                        |                                       |
|----------------------------------------|---------------------------------------|
| 36: Acou BD (Acoustic Bass Drum)       | 56: Cowbell                           |
| 37: Rim Shot                           | 60: High Bongo                        |
| 38: Acou SD (Acoustic Snare Drum)      | 61: Low Bongo                         |
| 39: Hand Clap                          | 62: Mt High Conga (Muted High Conga)  |
| 40: Elec SD (Electric Snare Drum)      | 63: High Conga                        |
| 41: Acou Low Tom (Acoustic Low Tom)    | 64: Low Conga                         |
| 42: Clsd Hi Hat (Closed Hi-Hat)        | 65: High Timbale                      |
| 43: Acou Low Tom (Acoustic Low Tom)    | 66: Low Timbale                       |
| 44: Open Hi Hat2                       | 67: High Agogo                        |
| 45: Acou Mid Tom (Acoustic Medium Tom) | 68: Low Agogo                         |
| 46: Open Hi Hat1                       | 69: Cabasa                            |
| 47: Acou Mid Tom (Acoustic Medium Tom) | 70: Maracas                           |
| 48: Acou Hi Tom (Acoustic High Tom)    | 71: Smba Whis S (Samba Whistle Short) |
| 49: Crash Cym (Crash Cymbal)           | 72: Smba Whis L (Samba Whistle Long)  |
| 50: Acou Hi Tom (Acoustic High Tom)    | 73: Quijada                           |
| 51: Ride Cym (Ride Cymbal)             | 75: Claves                            |
| 54: Tambourine                         |                                       |

(Stereo balance)

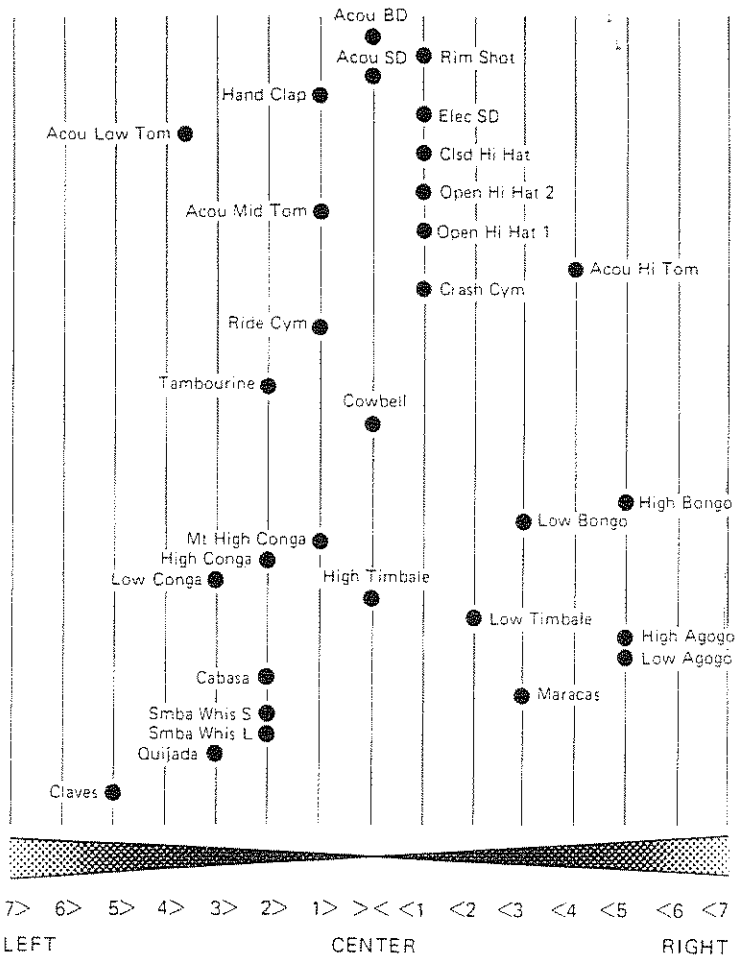

## DRUM BALANCE

To adjust the volume of the drums, press either DRUMS "▷" button to increase or "◁" button to decrease the volume ③⑦ (see TONE BALANCE). The display will respond with:

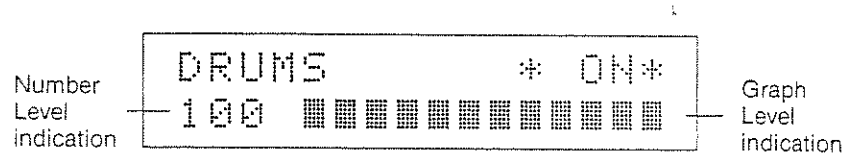

Pressing either DRUMS "▷" or "◁" buttons will cause the number and graph indication to increase or decrease.

\* After a few seconds if neither button is pressed, the display will return to the Master Display.

To quickly turn off the drums, press DRUMS "▷" and "◁" buttons simultaneously. The display will respond with:

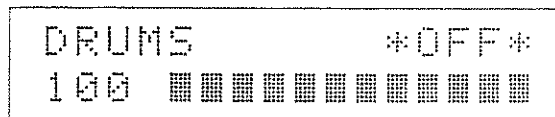

To turn the Drums on again, press the DRUMS "▷" and "◁" buttons again simultaneously.



# ACCOMPANIMENT

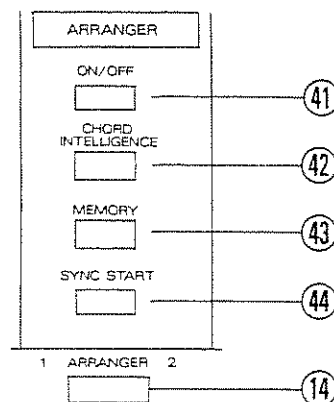

## ARRANGER ON/OFF

Pressing the ARRANGER ON/OFF button (41) (LED lights) automatically turns off the LOWER tone and introduces orchestral accompaniment from chords played on the lower section of the keyboard. To switch off the ARRANGER, press the same button again (LED is turned off, Lower Tone is reactivated).

### NOTE:

If you start the rhythm and stop then start again while pressing some keys with ARRANGER on, at second start, only the drums will play. Release the keys and play them again if you wish to hear the accompaniment.

## ARRANGER 1 & 2

Each rhythm includes two types of arrangements - Simple and Complex. Pressing the ARRANGER 1 & 2 button (14) will select between the two arrangements (left or right LED will light).

## VARIATION

Pressing the VARIATION button (39) (see RHYTHM section) (LED lights) will give a variation to each part of the rhythm (Drum track, Bass line and accompaniment).

To return to the basic (original) rhythms, press the VARIATION button once more (LED is turned off).

## FILL-IN

While playing the basic (original) rhythm, a Fill-in can be inserted by pressing the TO ORIGINAL button. This will result in a one measure fill-in and on completion will return to the basic rhythm.

While playing in the Variation, pressing the TO VARIATION button will result in a one measure fill-in and then on completion will return to the Variation.

If playing in the basic (original) rhythm and the TO VARIATION button is pressed, a one measure fill-in will occur and on completion will automatically proceed into the variation of the rhythm (VARIATION LED lights). Likewise if playing in the variation of a rhythm and the TO ORIGINAL button is pressed, a one measure fill-in will occur and on completion will automatically return to play the original rhythm (VARIATION LED is turned off).

\* If either of the FILL-IN buttons are pressed within the 1st and 3rd beats (1st and 2nd on Waltz rhythms), the fill-in will be performed for the remainder of that measure. If either of the Fill-in buttons are pressed within the 4th beat (3rd on Waltz rhythms), this operation will be interpreted as a pre-selection of the fill-in to start at the downbeat of the next measure.

## MEMORY

Pressing the MEMORY button (43) (LED lights) will activate a memory circuit which will continue to play the notes played left of the SPLIT — LOWER tone (Accompaniment when ARRANGER is turned on) and BASS after you release the keys. It will memorize and hold the notes until the next note(s) is played.

\* Pressing the MEMORY button will automatically activate the SPLIT 2 function if the latter was not selected previously.

## SYNC START

Pressing the SYNC START button (44) will synchronize the start of the rhythm to when a key is played on the lower section of the keyboard. The SYNC START button can be selected before pressing the INTRO/ENDING button (LED will begin to flash), pressing a key will now start the rhythm with an "introduction".

\* The SYNC START button will not function while a rhythm is running.

## PITCH BENDER/MODULATION

By moving the Pitch Bender/Modulation lever ⑳, bending of the UPPER tone can be obtained. Moving the lever to the right raises the pitch and moving the lever to the left lowers the pitch of the note. If the lever is released (central position), the note returns to normal pitch. This lever can be used to give a guitar bending effect or the sliding of the trombone and is used often in modern synthesizer playing.

The range of the pitch (when the lever is moved left or right) can be adjusted (see TRANS/TUNE/BEND in FUNCTION).

Pushing the same lever away from you will add modulation (vibrato/tremolo) to the UPPER tone. Releasing the lever will cancel the modulation effect.

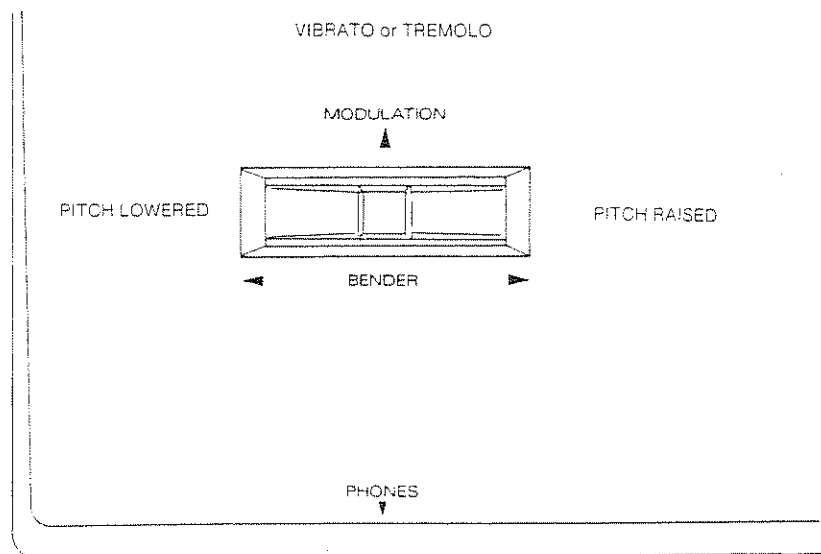

## CHORD INTELLIGENCE

Pressing the CHORD INTELLIGENCE button (42) (LED lights), enables you to play chords in the lower section of the keyboard with but a finger or two. The CHORD INTELLIGENCE system lets you play major, minor, seventh, minor seventh, major seventh, minor seventh b5th, diminished, augmented, suspended fourth and suspended seventh chords.

\* Pressing the CHORD INTELLIGENCE button will automatically select SPLIT 2 (if the latter was not selected previously).

The display will show at the bottom right the name of the chord being played in the lower section of the keyboard — CMa, Ebmi, D7, etc.

```
11 ROCK1      J=140
71 42 11      A mi
```

The chords recognized on the E-20 are:

- Major (Ma)
- Minor (mi)
- Seventh (7)
- Minor seventh (mi7)
- Major seventh (Ma7)
- Minor seventh b5th (Ø)
- Diminished (Dim)
- Augmented (Aug)
- Suspended fourth (Su4)
- Suspended seventh (Su7)

If any chord is played that is not included in the above list, asterisks will be shown in the display alongside the chord name — Ab\*\*\*, F\*\*\*, B\*\*\*, etc.

```
11 ROCK1      J=140
71 42 11      C#***
```

# PLAYING INTELLIGENT CHORDS

## • Major Chords (Ma)

Playing just one key in the lower section of the keyboard will produce the Major chord of the same name; that is, playing C will give you C Major; G will give you G Major, etc. :

C major

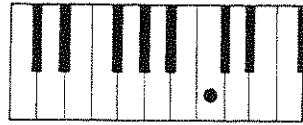

C

G major



G

## • Minor Chords (mi)

Minor Chords are formed by playing the one-note chord with an added note a minor third higher (three keys to the right).

Cm



C Eb

E<sup>b</sup> m

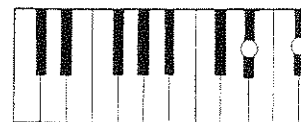

E<sup>b</sup> G<sup>b</sup>

## • Seventh Chords (7)

Two-note seventh chords can be formed by playing the one-note Major chord along with the note a whole step (two keys) to the left.

F7



E<sup>b</sup> F

B<sup>b</sup> 7

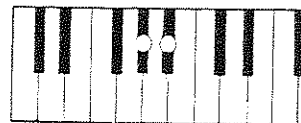

A<sup>b</sup> B<sup>b</sup>

## • Minor Seventh Chords (mi7)

Minor seventh chords are formed by playing the two notes that program a minor chord and then adding another note two keys to the left.

Cm7



B<sup>b</sup> C E<sup>b</sup>

E<sup>b</sup> m7



D<sup>b</sup> E<sup>b</sup> G<sup>b</sup>

• **Major Seventh Chords (Ma7)**

Major seventh chords can be formed by playing the one-note Major chord along with the note immediately to the left.

C<sup>Ma7</sup>

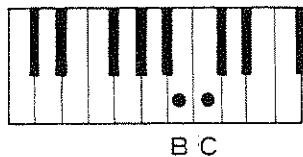

B C

A<sup>b</sup>Ma7

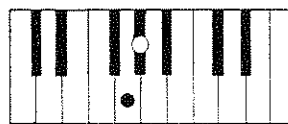

G A<sup>b</sup>

• **Minor Seventh b5th Chords (ø)**

Minor seventh b5th chords are played as four-note chords.

C<sup>m7</sup> b5

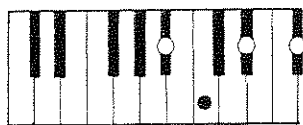

B<sup>b</sup> C E<sup>b</sup> D<sup>b</sup>

G<sup>m</sup> 7<sup>b</sup> 5

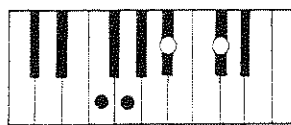

F G B<sup>b</sup> D<sup>b</sup>

• **Diminished Chords (Dim)**

Diminished chords are played as three-note chords.

B<sup>dim</sup>

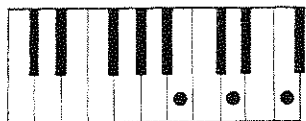

B D F

C<sup>dim</sup>

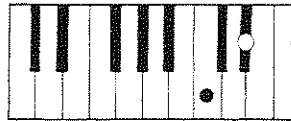

C E<sup>b</sup> G<sup>b</sup>

• **Augmented Chords (Aug)**

Augmented chords are played as three-note chords.

C<sup>aug</sup>

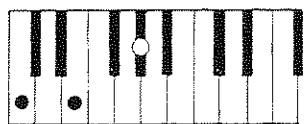

C E A<sup>b</sup>

F<sup>aug</sup>

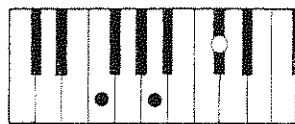

F A C<sup>#</sup>

## ● Suspended Fourth Chords (Su4)

Suspended fourth chords are played as three-note chords.

Csu4

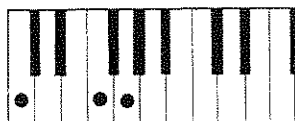

C F G

Fsu4

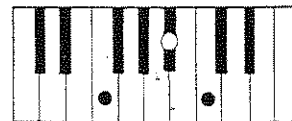

F B $\flat$  C

## ● Suspended Seventh Chords (Su7)

Suspended seventh chords are played as four-note chords.

Csu7

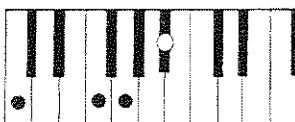

C F G B $\flat$

Fsu7

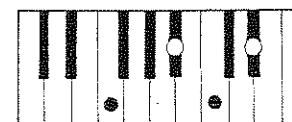

F B $\flat$  C E $\flat$

\* Without turning off the CHORD INTELLIGENCE, chords can still be played in the conventional way as well as the easy way described above.

## MELODY INTELLIGENCE

MELODY INTELLIGENCE automatically adds a musical counter-melody note to single-note melodies. This feature operates with or without the rhythm playing. The harmonizing notes added to the melody are programmed by the type of chord that you play on the lower section of the keyboard. Pressing the MELODY INTELLIGENCE button  automatically selects SPLIT 2 (if the latter was not selected previously).

MELODY INTELLIGENCE will only function while a note(s) is played in the lower section or held with the MEMORY feature.

Pressing the same button again will turn off MELODY INTELLIGENCE.

## ACCOMPANIMENT BALANCE

To adjust the volume of the accompaniment, press either ACCOMP "▷" button to increase or "◁" button to decrease the volume (35) (see TONE BALANCE).

The display will respond with:

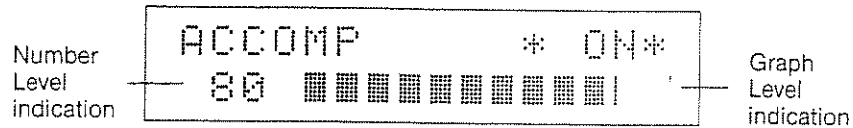

Pressing either ACCOMP "▷" or "◁" buttons will cause the number and graph indication to increase or decrease.

\* After a few seconds if neither button is pressed, the display will return to the Master Display.

To quickly turn off the Accompaniment, press ACCOMP "▷" and "◁" buttons simultaneously. The display will respond with:

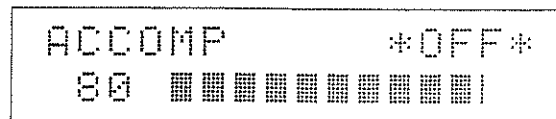

To turn the Accompaniment on again, press the ACCOMP "▷" and "◁" buttons again simultaneously.



# REVERB EFFECT

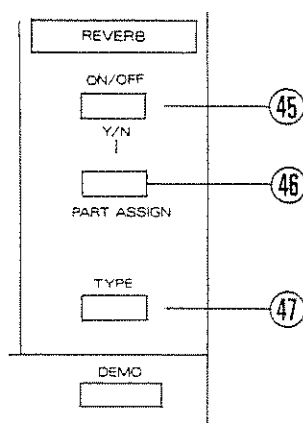

The E-20 also has a Digital Reverb unit built-in. The Reverb feature can be assigned (turned On/Off) for certain parts of the keyboard (see REVERB PART ASSIGN). There is also a choice of Reverb types (see REVERB TYPE).

The Reverb will be set up as follows when the instrument is turned on.

REVERB — On (LED on)

REVERB PART ASSIGN — UPPER part YES  
— LOWER part YES  
— DRUMS part YES

REVERB TYPE — Room 2

## REVERB PART ASSIGN

To turn off the Reverb effect completely, press the ON/OFF button (45) in the REVERB section (LED off). Pressing the same button again will turn on the Reverb effect (LED on).

To control the REVERB on/off for individual parts of the keyboard, press and hold the PART ASSIGN button (46). The display will respond with:

```
UPPER part  
Reverb      *YES*
```

To turn off the Reverb effect for the UPPER tones, press the Y/N button (45). Pressing the same button again will turn on the Reverb effect. The display will indicate the YES/NO setting.

Press and hold the PART ASSIGN button again. The display will respond with:

```
LOWER part  
Reverb      *YES*
```

To turn off the Reverb effect for the LOWER tones, press the Y/N button (45). Pressing the same button again will turn on the Reverb effect. The display will indicate the YES/NO setting.

Press and hold the PART ASSIGN button once more. The display will respond with:

```
DRUMS  Part
Reverb          *YES*
```

To turn off the Reverb effect for the drums, press the Y/N button (45). Pressing the same button again will turn on the Reverb effect. The display will indicate the YES/NO setting.

A few seconds after the PART ASSIGN button has been released, the display will return to the Master Display.

## REVERB TYPE

To change the type of Reverb effect, press the TYPE button (47) in the REVERB section. The display will respond with:

```
REVERB type
2 = Room 2
```

Pressing the same button repeatedly will “scroll” through and select the different types of Reverb. The eight types of Reverb effect available are as follows:

- 1 = Room 1
- 2 = Room 2 (turn-on setting)
- 3 = Hall 1
- 4 = Hall 2
- 5 = Plate 1
- 6 = Plate 2
- 7 = Delay 1
- 8 = Delay 2

The display will indicate the Reverb effect chosen.

\* REVERB ON/OFF and REVERB TYPE can be recorded into the USER PROGRAMS.

# FUNCTION

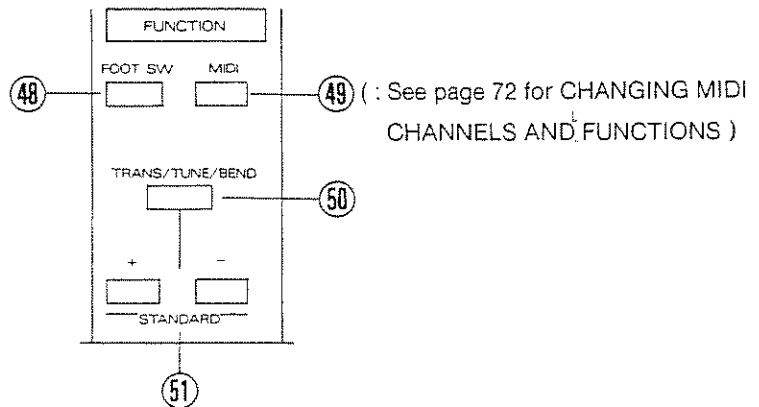

## TRANS/TUNE/BEND

This button controls the following three functions of the E-20.

### TRANSCOPE

The Transpose feature lets you play in one key and hear the music in another key.

Press the TRANS/TUNE/BEND button (50) once. The display will respond with:



STANDARD pitch (C) is always selected when the instrument is turned on.

To change the pitch (Transpose) of the instrument, press the buttons (51) immediately below the TRANS/TUNE/BEND button, "+" to raise the pitch and "-" button to lower the pitch. The buttons can be pressed just once to change the pitch by one semitone or if held will "scroll" through the different keys. The possible pitches that are selectable are C, C#, D, Eb, E, F, F#, G, Ab, A, Bb and B. The display will indicate which key the E-20 has been changed to.

To quickly return the instrument to STANDARD pitch, press both "+" and "-" buttons simultaneously. The display will indicate C.

After a few seconds the display will return to the Master Display.

## MASTER TUNE

The Master Tune feature enables you to slightly raise or lower the pitch of your E-20. This feature is extremely useful when playing with other instruments that may not exactly match the pitch of the E-20.

Press the TRANS/TUNE/BEND button repeatedly until the display responds with:

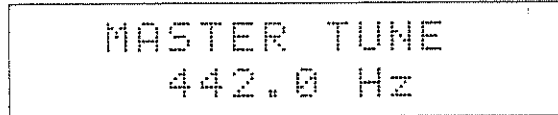

```
MASTER TUNE
442.0 Hz
```

To change the Master Tune of the instrument, press the buttons immediately below the TRANS/TUNE/BEND button, "+" to raise the Master Tune and "-" button to lower the Master Tune. The button can be pressed just once to change the Master Tune by one degree or if held will "scroll" through the Master Tune range. The selectable range is from 427.5 Hz to 452.6 Hz.

The display will indicate the change in position of the Master Tune range.

\* Any changes of Master Tune made will be remembered even after the instrument is switched off.

To quickly return the instrument to STANDARD Tune, press both "+" and "-" buttons simultaneously. The display will indicate "442.0 Hz".

After a few seconds the display will return to the Master Display.

## PITCH BENDER RANGE

This feature enables you to set the range of Pitch Bender (when using the Pitch Bend lever).

The E-20 selects a Pitch Bender range of 2 when it is turned on. Moving the lever to the right will raise the pitch by two semitones and moving the lever to the left will lower the pitch by two semitones.

To change the range of the Pitch Bender, press the TRANS/TUNE/BEND button repeatedly until the display responds with:

PITCH BENDER  
RANGE = 2

Then press the buttons immediately below the TRANS/TUNE/BEND button, "+" to raise the range and "-" to lower the range. The buttons can be pressed just once to change the range by one degree or if held will scroll through the Pitch Bender range. The selectable range is from the following:

- 1 = one semitone
- 2 = one tone
- 3 = one and a half tones
- 4 = two tones
- 5 = two and a half tones
- 6 = three tones
- 7 = three and a half tones
- 8 = twelve tones (octave)

The display will indicate the change in range of the Pitch Bender.

\*Any changes of the Pitch Bender range made will be remembered even after the instrument is switched off.

To quickly return the instrument to the STANDARD range, press both "+" and "-" buttons simultaneously. The display will indicate "RANGE 2".

After a few seconds the display will return to the MASTER DISPLAY.

\* TRANSPOSE and PITCH BENDER range settings can be recorded into the USER PROGRAMS.

## FOOTSWITCH ASSIGN

With the optional footswitch, certain functions of the E-20 can be controlled by foot. The input socket (28) for the footswitch is located on the rear panel.

The Sustain function for the footswitch is set when the E-20 is turned on.

To select the different footswitch functions, press the FOOTSWITCH button (48). The display will respond with:

```
FOOT SWITCH to :  
SUSTAIN
```

Pressing the same button repeatedly will "scroll" through and select the different functions. The possible footswitch functions are as follows:

- SUSTAIN
- RHYTHM START/STOP
- FILL-IN TO VARIATION
- FILL-IN TO ORIGINAL
- RHYTHM INTRO/ENDING
- SPLIT ON/OFF\*
- ARRANGER 1/2

\* The previously selected SPLIT position, 1 or 2, will be selected.

The display will indicate the function selected.

A few seconds after the FOOTSWITCH button has been released, the display will return to the Master Display.



# USER PROGRAMS

One of the advantages of the E-20 is its ability to produce a wide variety of instrumental tones and effects. Normally, changing from one tone or effect to another involves activating several buttons. However, with Roland's digital technology, 8 User Programs provided on the instrument enable you to record 8 complete panel registrations of your choice which are recallable at the touch of a button.

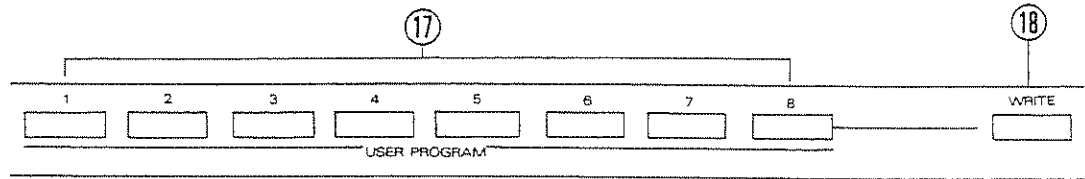

The following functions can be recorded into the User Programs:

- Upper Tone
- Lower Tone
- Bass Tone
- Volume Balance of each section (Upper, Lower, Accomp, Bass, Drum)
- Split On/Off, 1 & 2
- Rhythm
- Tempo
- Variation
- Arranger On/Off, 1 & 2
- Memory
- Sync Start
- Chord Intelligence
- Melody Intelligence
- Reverb On/Off
- Reverb Type
- Manual Drum
- Footswitch Assign
- Transpose
- Pitch Bender Range

The E-20 will arrive with 8 factory User Programs preset with the following configurations:

#### USER PROGRAM 1

Upper Tone — 31 SYN BRASS  
Lower Tone — 11 ELEC PIANO 1  
Bass Tone — 71 ACOU BASS 1  
Volume Balances — as turn-on condition  
Split — On, 2  
Rhythm — 15 FUNK 1  
Tempo — 110  
Variation — Off  
Arranger — On, 2  
Memory — Off  
Sync Start — Off  
Chord Intelligence — Off  
Melody Intelligence — Off  
Reverb — On  
Reverb type — Hall 1  
Manual Drum — Off  
Footswitch Assign — Sustain  
Transpose — C

#### USER PROGRAM 2

Upper Tone — 57 DOCTOR SOLO  
Lower Tone — 52 ATMOSPHERE  
Bass Tone — 72 ACOU BASS 2  
Volume Balances — as turn-on condition  
Split — On, 2  
Rhythm — 17 BALLAD  
Tempo — 120  
Variation — Off  
Arranger — On, 2  
Memory — Off  
Sync Start — Off  
Chord Intelligence — Off  
Melody Intelligence — Off  
Reverb — On  
Reverb type — Hall 1  
Manual Drum — Off  
Footswitch Assign — Sustain  
Transpose — C

#### USER PROGRAM 3

Upper Tone — 85 MARIMBA  
Lower Tone — 16 CLAVI  
Bass Tone — 73 ELEC BASS 1  
Volume Balances — as turn-on condition  
Split — On, 2  
Rhythm — 25 REGGAE  
Tempo — 140  
Variation — Off  
Arranger — On, 2  
Memory — Off  
Sync Start — Off  
Chord Intelligence — Off  
Melody Intelligence — Off  
Reverb — On  
Reverb type — Hall 1  
Manual Drum — Off  
Footswitch Assign — Sustain  
Transpose — C

#### USER PROGRAM 4

Upper Tone — 64 ELEC GTR 2  
Lower Tone — 21 ELEC ORGAN 1  
Bass Tone — 71 ACOU BASS 1  
Volume Balances — as turn-on condition  
Split — On, 2  
Rhythm — 27 ROCK 'N ROLL  
Tempo — 172  
Variation — Off  
Arranger — On, 2  
Memory — Off  
Sync Start — Off  
Chord Intelligence — Off  
Melody Intelligence — Off  
Reverb — On  
Reverb type — Delay 1  
Manual Drum — Off  
Footswitch Assign — Sustain  
Transpose — C

## USER PROGRAM 5

Upper Tone — 35 TROMBONE  
Lower Tone — 11 ELEC PIANO 1  
Bass Tone — 71 ACOU BASS 1  
Volume Balances — as turn-on condition  
Split — On, 2  
Rhythm — 31 SWING  
Tempo — 120  
Variation — Off  
Arranger — On, 2  
Memory — Off  
Sync Start — Off  
Chord Intelligence — Off  
Melody Intelligence — Off  
Reverb — On  
Reverb type — Hall 1  
Manual Drum — Off  
Footswitch Assign — Sustain  
Transpose — C

## USER PROGRAM 7

Upper Tone — 27 SHAKUHACHI  
Lower Tone — 24 PIPE ORGAN 1  
Bass Tone — 24 PIPE ORGAN 1  
Volume Balances — as turn-on condition  
Split — On, 2  
Rhythm — 41 BAROQUE  
Tempo — 140  
Variation — Off  
Arranger — On, 1  
Memory — Off  
Sync Start — Off  
Chord Intelligence — Off  
Melody Intelligence — Off  
Reverb — On  
Reverb type — Hall 1  
Manual Drum — Off  
Footswitch Assign — Sustain  
Transpose — C

## USER PROGRAM 6

Upper Tone — 68 HARMONICA  
Lower Tone — 41 STRING SECT 1  
Bass Tone — 71 ACOU BASS 1  
Volume Balances — as turn-on condition  
Split — On, 2  
Rhythm — 34 COUNTRY  
Tempo — 136  
Variation — Off  
Arranger — On, 2  
Memory — Off  
Sync Start — Off  
Chord Intelligence — Off  
Melody Intelligence — On  
Reverb — On  
Reverb type — Hall 1  
Manual Drum — Off  
Footswitch Assign — Sustain  
Transpose — C

## USER PROGRAM 8

Upper Tone — 85 MARIMBA  
Lower Tone — 21 ELEC ORGAN 1  
Bass Tone — 71 ACOU BASS 1  
Volume Balances — as turn-on condition  
Split — On, 2  
Rhythm — 44 CHA CHA  
Tempo — 140  
Variation — Off  
Arranger — On, 2  
Memory — Off  
Sync Start — Off  
Chord Intelligence — Off  
Melody Intelligence — Off  
Reverb — On  
Reverb type — Hall 1  
Manual Drum — Off  
Footswitch Assign — Sustain  
Transpose — C

## WRITING A PANEL CONFIGURATION

1. Select any of the recordable functions you wish to record into the User Program.
2. Press the WRITE button  and hold. The display will respond with:

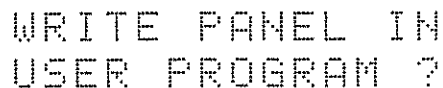

WRITE PANEL IN  
USER PROGRAM ?

3. While pressing the WRITE button, press one of the USER PROGRAM buttons (1-8) . The panel has now been recorded into the User Program number pressed.

To change another User Program, follow the same procedure as above.

The User Program contents will be retained until they are further changed. Turning the instrument off will not erase a recorded User Program.

However, if you wish to record more than 8 User Program configurations, the User Programs already recorded can be saved onto an optional memory card (see MEMORY CARD).

The display will respond with:

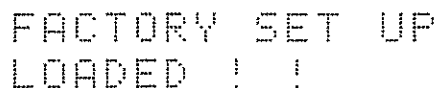

FACTORY SET UP  
LOADED ! !

**NOTE:** This procedure will erase any songs contained in the Song Composer Memory. To retain those songs, follow the procedure - WRITING SONGS IN SONG COMPOSER ONTO CARD on page 60.

To activate any of the User Programs, simply press the number button you wish to use. The panel setting in that particular program will be recalled and the display will indicate next to the UPPER tone number, the number of the User Program in use. To cancel a User Program, press the same User Program button a second time. The program will now be cancelled and the panel setting prior to selecting a User Program will return. This is called User Program 0 (not indicated in the display).

# SONG COMPOSER

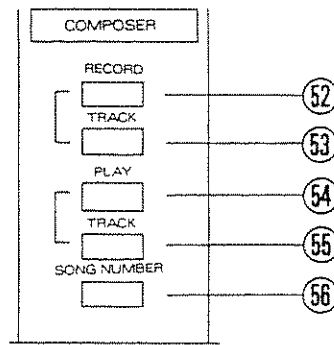

The SONG COMPOSER is a unique «Melody and Accompaniment Digital Recorder» that can record and store three complete songs of melody and accompaniment for playback at any time.

The tempo of the recorded song is variable, so that a recording made at a slow speed can be replayed at a faster (or slower) tempo. What is actually recorded is the chord progression, melody notes, tones and effects.

Accompaniment and melody can be recorded simultaneously, but if recording separately, we suggest that the accompaniment be recorded first.

The maximum amount of chord changes recordable in one measure is 96.

The minimum length of melody notes that can be recorded in one measure is a sixty-fourth note triplet (  ).

Accompaniment, melody notes, tones and effects recorded in the Composer will be retained until they are changed. Turning the instrument off will not erase a recorded track or song.

However, if you wish to record more than three songs, the songs already recorded in the Composer can be saved onto an optional memory card (see MEMORY CARD).

## RECORDING A SONG

1. Stop the rhythm if already playing.
2. Press the RECORD TRACK button  in the Song Composer section. The display will respond with:

|        |     |      |
|--------|-----|------|
| SONG 1 | REC | PLAY |
|        | L+U | L+U  |

To record both accompaniment and melody simultaneously, ensure that both "L" and "U" are visible under "REC" in the display. If not, press the RECORD TRACK button one or two times. To record accompaniment only, press the RECORD TRACK button till only "L" appears in the display. Likewise if recording melody only, press the RECORD TRACK button till only "U" appears in the display.

If you wish to record on one track and hear the other playing back (when recording melody over previously recorded accompaniment for example), make sure that only the track you wish to record on appears under REC and only the track you wish to hear playing back appears under PLAY. Then press RECORD and PLAY buttons (both LEDs will light), and follow the procedures 3 and 4.

\* After a few seconds if the TRACK button is not pressed, the display will return to the Master Display.

3. Select the rhythm you wish to use while recording, and select tones and effects.
4. Press the RECORD button (52) (LED lights), (pressing RECORD button will automatically select SPLIT 2 position if it was switched off).

The recording can be started in three ways:

- a) Press the START/STOP button and the rhythm and recording starts immediately.
- b) Press the SYNC START button (LED lights). Then press a chord in the accompaniment section of the keyboard. Rhythm and recording will begin automatically (LED off).
- c) Press the INTRO/ENDING button and the recording will start with the "introduction" to the rhythm selected.

\* The Intro can also be selected with the SYNC START function. Press the INTRO/ENDING button **after pressing** the SYNC START button (Sync Start LED begins to flash). Then play a chord in the accompaniment section and the recording will begin with the "introduction".

In addition to recording chord and melody note information, the Composer can also record the following functions:

- Tone change (UPPER, LOWER, BASS)
- Rhythm change
- Tempo change
- Variation
- Arranger On/Off, 1 & 2
- Fill In to Variation
- Fill In to Original
- Intro
- Ending
- User Program change
- Volume Balance change (UPPER, BASS, ACCOMP, DRUMS)
- Pitch Bend
- Modulation
- Sustain (using the optional footswitch)

\* The Song Composer will inform you when you are approaching the full memory capacity of the song you are recording by flashing the RECORD LED. This occurs when only 10% of the memory is remaining.

\*When the total memory capacity is reached, recording will be automatically switched off. The rhythm will automatically be switched off and the RECORD LED will be turned off.



To record another song (three songs are possible), press the SONG NUMBER button (56) . The display will respond with the recording/playback indication:

```
SONG 1  REC PLAY  
          L+U L+U
```

Press the SONG NUMBER button once more and the display will change to:

```
SONG 2  REC PLAY  
          L+U L+U
```

To record the second song follow the same procedures as for SONG 1.

Pressing the SONG NUMBER button two more times will change the Song Number to SONG 3 and the third song can now be recorded using the same procedures as for SONG 1.

**NOTE:** Using the PITCH BENDER/MODULATION LEVER, TEMPO CHANGE and TONE BALANCE features on record will use up a lot of the song memory.

## PLAYING BACK A SONG

1. To play back one of the three songs, press the SONG NUMBER button, and select which song you wish to replay by pressing the same button again once, or twice to change the song number from SONG 1 to SONG 2 or SONG 3.
2. Then press the PLAY TRACK button **(55)** and select which track you wish to hear by pressing the same button again once or twice, to select Lower (accomp) "L", Upper "U", or Lower and Upper "L+U".
3. Press the PLAY button **(54)** (LED lights).
4. Press the START/STOP button and the playback of the song selected will begin.

-or-

Press the SYNC START button, then press a note in the lower section of the keyboard.

The song will automatically stop after playing the final measure. The song can be stopped at any time by pressing the START/STOP button (PLAY LED is turned off).

If you wish the song to playback repeatedly, press the PLAY button one more time (LED will start to flash). To cancel the "loop" feature press the PLAY button again until the LED lights constantly.

- \* If the song has been recorded with INTRO/ENDING, even if the "loop" function has been selected, this function will not work.
- \* Both tracks "L" and "U" of each song can be re-recorded (modified) by following the "RECORDING A SONG" procedures and selecting which track you wish to modify.
- \* If you wish to load and play Composer Songs already recorded on the optional Memory Card, see MEMORY CARD and follow the "PLAYING BACK A SONG" procedures above.

# MEMORY CARD

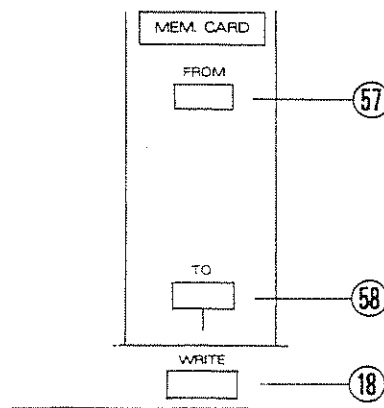

An optional Memory Card (M-256D, M-256E) is available from your Roland dealer.

With the Memory Card, 3 songs recorded in SONG COMPOSER and/or 8 USER PROGRAMS can be "written" and stored onto the card (To Card) making it possible to record additional songs or panel configurations in the E-20 internal memory.

The data stored onto the card can then be "loaded" and returned to the E-20 (From Card) for use at any time.

## WRITING SONG COMPOSER SONGS ONTO CARD

To "write" and store song(s) recorded in Song Composer onto the Memory Card:

1. Insert the Memory Card into the MEMORY CARD slot (27) with the label facing upwards.
2. Make sure that the PROTECT switch of the Memory Card is set to OFF position.
3. Press and hold the TO button (58) in the MEM. CARD section. The display will respond with:

```
SONG COMPOSER  
TO MEMORY CARD
```

4. While holding the TO button, press the WRITE button (18). If the card has not been used before, the display will respond with:

```
ILLEGAL CARD !!  
WRITE AGAIN ?
```

5. While holding the TO button, press the WRITE button once more. The display will respond with:

```
OK !!  
SAVE COMPLETE
```

The whole contents of the Song Composer memory (1, 2 & 3 songs) are now stored in the card. The Song Composer memory in the card can be loaded and returned to the E-20 for playback at any time.

After releasing both buttons, the display will return to the Master Display.

\* To protect the data (Songs and User Programs) stored on the card, set the PROTECT switch to ON before removing the card.

## LOADING THE SONGS INTO THE E-20

To load the card's Song Composer songs into the E-20:

1. Insert the Memory Card into the MEMORY CARD slot.
2. Press and hold the FROM button (57) in the MEM. CARD section. The display will respond with:

```
SONG COMPOSER  
FROM MEMORY CARD
```

3. While holding the FROM button, press the WRITE button. The display will respond with:

```
OK !!  
LOAD COMPLETE
```

All the card's Song Composer songs are now loaded into the E-20.

After releasing both buttons, the display will return to the Master Display.

With the Memory Card, it is also possible to write and store all the new settings that you have recorded in the User Programs.

## WRITING USER PROGRAMS ONTO CARD

To "write" and store User Programs onto the Memory Card:

1. Insert the Memory Card into the MEMORY CARD slot.
2. Make sure that the PROTECT switch is set to the OFF position.
3. Press the TO button in the MEM. CARD section **twice** and hold it. The display will respond with:

```
USER PROGRAMS  
TO MEMORY CARD
```

4. While holding the TO button, press the WRITE button. If the card has not been used before, the display will respond with:

```
ILLEGAL CARD !!  
WRITE AGAIN ?
```

5. While holding the TO button press the WRITE button once more. The display will respond with:

```
OK !!  
SAVE COMPLETE
```

The whole contents of the User Programs are now stored onto the card.

After releasing both buttons, the display will return to the Master Display.

\* To protect the data (Songs and User Programs) stored on the card, set the PROTECT switch to ON before removing the card.

If desired, the "factory preset" User Program settings can be reloaded into the E-20. To reload the factory preset User Program settings, turn the E-20 off. Press the WRITE button and hold it. While continuing to hold the WRITE button turn the E-20 on. Hold the WRITE button until the display responds with:

```
FACTORY SET UP  
LOADED ! !
```

**NOTE:** This procedure will erase any songs contained in the Song Composer memory. To retain those songs, follow the procedure — WRITING SONGS IN SONG COMPOSER ONTO CARD on page 60.

The User Programs can be loaded and returned to the E-20 for use at any time.

### LOADING USER PROGRAMS INTO THE E-20

To load the User Programs into the E-20:

1. Insert the Memory Card into the MEMORY CARD slot.
2. Press the FROM button in the MEM. CARD section **twice** and hold it. The display will respond with:

```
USER PROGRAMS  
FROM MEMORY CARD
```

3. While holding the FROM button, press the WRITE button. The display will respond with:

```
OK !!  
LOAD COMPLETE
```

The User Programs are now loaded into the E-20.

The Song Composer and User Programs can also be saved (and loaded) simultaneously.

## WRITING BOTH SONGS AND USER PROGRAMS ONTO CARD

To write and store both Songs and User Programs onto the Memory Card:

1. Insert the Memory Card into the MEMORY CARD slot.
2. Make sure that the PROTECT switch is set to the OFF position.
3. Press the TO button **three times** and hold it. The display will respond with:

```
SONGS/USER PROG.  
TO MEMORY CARD
```

4. While holding the TO button, press the WRITE button. The display will respond with:

```
OK!!  
SAVE COMPLETE
```

The Song Composer songs and User Programs will now be stored onto the card.

\* To protect all data stored on the card, set the PROTECT switch to the ON position before removing the card.



## LOADING BOTH SONGS AND USER PROGRAMS INTO THE E-20

To load both Song Composer songs and User Programs into the E-20:

1. Insert the Memory Card into the MEMORY CARD slot.
2. Press the FROM button **three times** and hold it. The display will respond with:

```
SONGS/USER PROG.  
FROM MEMORY CARD
```

3. While holding the FROM button, press the WRITE button. The display will respond with:

```
OK!!  
LOAD COMPLETE
```

After releasing both buttons, the display will return to the Master Display.

## ERROR MESSAGES

If any of the (write/load) procedures have not been carried out correctly, the following Error messages will be displayed:

| DISPLAY                 | REASON                                                                                                                                                                               | REMEDY                                                                                                                                                                                                                   |
|-------------------------|--------------------------------------------------------------------------------------------------------------------------------------------------------------------------------------|--------------------------------------------------------------------------------------------------------------------------------------------------------------------------------------------------------------------------|
| CARD NOT READY          | — The card has not been inserted.                                                                                                                                                    | — Insert the card and repeat procedure.                                                                                                                                                                                  |
| ILLEGAL CARD !!         | — The card is new.<br>— The battery has not been inserted.<br>— The card has been programmed on other Roland instruments.<br>— The card now in the MEMORY CARD slot is a Style Card. | — Press the WRITE button again.<br>— Insert battery and repeat procedure.<br>— If you wish to erase the data on the card, press the WRITE button again.<br>— Insert a Memory Card M-256D or M-256E and repeat procedure. |
| MEMORY CARD PROTECTED ! | — The Protect switch is set to the ON position                                                                                                                                       | — Set the Protect switch to the OFF position and repeat procedures.                                                                                                                                                      |

# STYLE CARD

Additional rhythms are available from optional Style Cards available from your Roland dealer.

## PLAYING RHYTHMS FROM THE CARD

To play rhythms from the Style Card:

1. Insert the Style Card into the MEMORY CARD slot (27).
2. Press CARD button (40) in the Rhythm section (see RHYTHM SECTION).
3. Press one of the NUMBER buttons, 1-8, in the Rhythm section. The number and name of the card rhythm will appear in the display.

**Example:**

|    |        |       |
|----|--------|-------|
| C1 | MOTOWN | ♩=120 |
| XX | XX     | XX    |

To START/STOP and to select VARIATION, ARRANGER 1 & 2, FILL-IN, INTRO/ENDINGS, follow the same procedures as were used for the built-in rhythms on page 27.

\* Inserting a Style Card into the E-20 will not erase the built-in rhythms.

\* Do not remove the Style Card when a rhythm from the card is being played.

## ERROR MESSAGES

If any of the above procedures have not been carried out correctly, the Error messages below will be displayed.

| DISPLAY         | REASON                                               | REMEDY                                      |
|-----------------|------------------------------------------------------|---------------------------------------------|
| CARD NOT READY  | — The Style Card has not been inserted.              | — Insert card and repeat procedure.         |
| ILLEGAL CARD !! | — The card now in the card slot is not a Style Card. | — Insert a Style Card and repeat procedure. |

# MIDI CONTROL

M.I.D.I. is the acronym for Musical Instrument Digital Interface.

MIDI is a standardized interface by which all digital musical instruments also equipped with MIDI connections can exchange data. This means that your E-20 can be used as a MIDI control keyboard — to control other MIDI devices (keyboard, sequencer, etc.) or as a MIDI sound source (to be controlled by other MIDI devices).

## CONNECTIONS

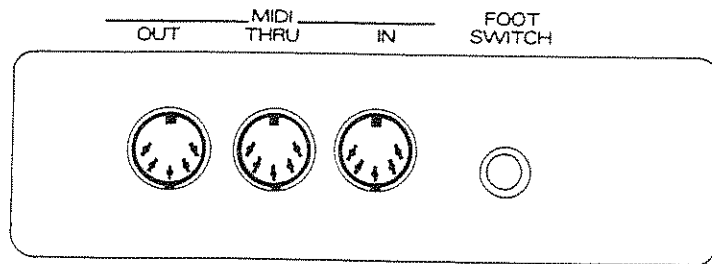

**MIDI sockets on the rear panel**

- MIDI OUT socket  
Use this socket for sending MIDI signals from the E-20 to control external MIDI devices.
  - MIDI THRU socket  
An exact copy of the signal fed into the MIDI IN is sent out through this socket.
  - MIDI IN socket.  
Use this socket for feeding MIDI signals from an external MIDI device to control the E-20 and make it operate as a sound source.
- \* The signal fed into the MIDI IN is not sent out through MIDI OUT.

Example:

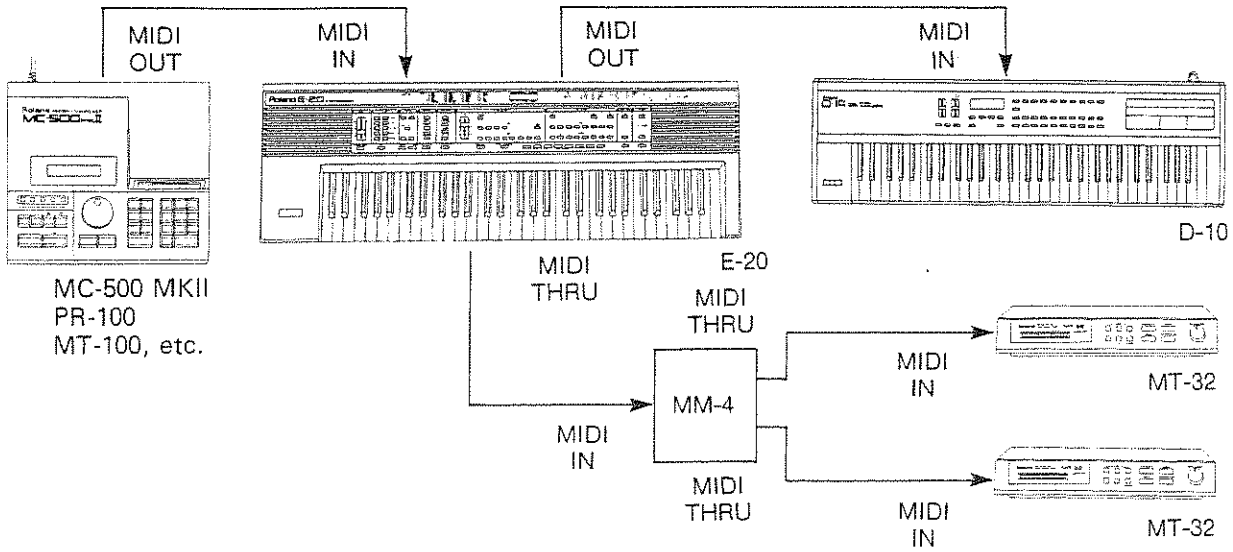

\* When connecting, switch off the E-20 and all other MIDI devices.

\* Do not connect more than 3 MIDI devices through the MIDI THRU sockets. Use the optional MIDI THRU box (MM-4) in this case.

# 128 TONES AVAILABLE by EXTERNAL MIDI PROGRAM CHANGE

When using an external MIDI device to control the sound source within the E-20, a total of 128 tones can be played.

The 128 tones available are:

| Tone Name     | Prog-No. | HP-Prog. |
|---------------|----------|----------|
| Elec Piano 1  | 001      | A11      |
| Elec Piano 2  | 002      | A12      |
| Elec Piano 3  | 003      | A13      |
| Honkytonk     | 004      | A14      |
| Harpsichord 1 | 005      | A15      |
| Clavi 1       | 006      | A16      |
| Celesta 1     | 007      | A17      |
| Harp 1        | 008      | A18      |
| Elec Organ 1  | 009      | A21      |
| Elec Organ 2  | 010      | A22      |
| Elec Organ 3  | 011      | A23      |
| Pipe Organ 1  | 012      | A24      |
| Pipe Organ 2  | 013      | A25      |
| Breathpipe    | 014      | A26      |
| Shakuhachi    | 015      | A27      |
| Accordion     | 016      | A28      |
| Syn Brass 1   | 017      | A31      |
| Syn Brass 2   | 018      | A32      |
| Syn Brass 3   | 019      | A33      |
| Trumpet 1     | 020      | A34      |
| Trombone 1    | 021      | A35      |
| French Horn 1 | 022      | A36      |
| Brass Sect 1  | 023      | A37      |
| Sax 1         | 024      | A38      |
| String Sect 1 | 025      | A41      |
| String Sect 2 | 026      | A42      |
| Pizzicato     | 027      | A43      |
| Violin 1      | 028      | A44      |
| Orch Hit      | 029      | A45      |
| Chorale       | 030      | A46      |
| Soundtrack    | 031      | A47      |
| Whistle       | 032      | A48      |
| Fantasy       | 033      | A51      |
| Atmosphere    | 034      | A52      |
| Warm Bell     | 035      | A53      |
| Echo Bell     | 036      | A54      |
| Water Bell    | 037      | A55      |
| Echo Pan      | 038      | A56      |
| Doctor Solo   | 039      | A57      |
| Square Wave   | 040      | A58      |
| Guitar 1      | 041      | A61      |
| Guitar 2      | 042      | A62      |
| Elec Guitar 1 | 043      | A63      |
| Elec Guitar 2 | 044      | A64      |
| Flute 1       | 045      | A65      |
| Pan Pipes     | 046      | A66      |
| Clarinet 1    | 047      | A67      |
| Harmonica     | 048      | A68      |
| Acou Bass 1   | 049      | A71      |
| Acou Bass 2   | 050      | A72      |
| Elec Bass 1   | 051      | A73      |
| Slap Bass 1   | 052      | A74      |
| Slap Bass 2   | 053      | A75      |
| Fretless 1    | 054      | A76      |
| Fretless 2    | 055      | A77      |
| Contrabass    | 056      | A78      |
| Vibe 1        | 057      | A81      |
| Vibe 2        | 058      | A82      |
| Glock         | 059      | A83      |
| Xylophone     | 060      | A84      |
| Marimba       | 061      | A85      |
| Jungle Tune   | 062      | A86      |
| Ice rain      | 063      | A87      |
| Telephone     | 064      | A88      |

| Tone Name     | Prog-No. | HP-Prog. |
|---------------|----------|----------|
| Acou Piano 1  | 065      | B11      |
| Acou Piano 2  | 066      | B12      |
| Acou Piano 3  | 067      | B13      |
| Elec Piano 4  | 068      | B14      |
| Elec Organ 4  | 069      | B15      |
| Pipe Organ 3  | 070      | B16      |
| Harpsichord 2 | 071      | B17      |
| Harpsichord 3 | 072      | B18      |
| Clavi 2       | 073      | B21      |
| Clavi 3       | 074      | B22      |
| Celesta 2     | 075      | B23      |
| Syn Brass 4   | 076      | B24      |
| Syn Bass 1    | 077      | B25      |
| Syn Bass 2    | 078      | B26      |
| Syn Bass 3    | 079      | B27      |
| Syn Bass 4    | 080      | B28      |
| Harmo Pan     | 081      | B31      |
| Glasses       | 082      | B32      |
| Funny Vox     | 083      | B33      |
| Oboe 2001     | 084      | B34      |
| Schooldaze    | 085      | B35      |
| Bellsinger    | 086      | B36      |
| String Sect 3 | 087      | B37      |
| Violin 2      | 088      | B38      |
| Cello 1       | 089      | B41      |
| Cello 2       | 090      | B42      |
| Harp 2        | 091      | B43      |
| Sitar         | 092      | B44      |
| Elec Bass 2   | 093      | B45      |
| Flute 2       | 094      | B46      |
| Piccolo 1     | 095      | B47      |
| Piccolo 2     | 096      | B48      |
| Recorder      | 097      | B51      |
| Sax 2         | 098      | B52      |
| Sax 3         | 099      | B53      |
| Sax 4         | 100      | B54      |
| Clarinet 2    | 101      | B55      |
| Oboe          | 102      | B56      |
| English Horn  | 103      | B57      |
| Bassoon       | 104      | B58      |
| Trumpet 2     | 105      | B61      |
| Trombone 2    | 106      | B62      |
| French Horn 2 | 107      | B63      |
| Tuba          | 108      | B64      |
| Brass Sect 2  | 109      | B65      |
| Syn Mallet    | 110      | B66      |
| Windbell      | 111      | B67      |
| Tube Bell     | 112      | B68      |
| Koto          | 113      | B71      |
| Sho           | 114      | B72      |
| Whistle 2     | 115      | B73      |
| Bottleblow    | 116      | B74      |
| Timpani       | 117      | B75      |
| Melodic Tom   | 118      | B76      |
| Deep Snare    | 119      | B77      |
| Elec Perc 1   | 120      | B78      |
| Elec Perc 2   | 121      | B81      |
| Taiko         | 122      | B82      |
| Taiko Rim     | 123      | B83      |
| Cymbal        | 124      | B84      |
| Castanets     | 125      | B85      |
| Triangle      | 126      | B86      |
| Bird Tweet    | 127      | B87      |
| One Note Jam  | 128      | B88      |

\* "HP-Prog." stands for the Program Change numbers transmitted by the Roland HP Piano series.

## CHANGING MIDI CHANNELS AND FUNCTIONS

Pressing the MIDI button (49) (see page 45) repeatedly will cause the following MIDI functions/channels and their preset values to "scroll" through in the display (E-20 preset values activated by turning the E-20 on.).

| DISPLAY                              | CHANGEABLE VALUES                                                |
|--------------------------------------|------------------------------------------------------------------|
| UPPER part<br>MIDI ch 4 * ON*        | MIDI Channel 1-16<br>TX (Transmit) & RX (Receive) Channel ON/OFF |
| LOWER part<br>MIDI ch 3 * ON*        | As above                                                         |
| DRUMS part<br>MIDI ch 10 * ON*       | As above                                                         |
| BASS part<br>MIDI ch 2 * ON*         | As above                                                         |
| ACCOMP 1 part<br>MIDI ch 5 * ON*     | As above<br>(Effective when in ARRANGER 2 mode)                  |
| ACCOMP 2 part<br>MIDI ch 6 * ON*     | As above<br>(Effective when in ARRANGER 2 mode)                  |
| ACCOMP 3 part<br>MIDI ch 7 * ON*     | As above<br>(Effective when in ARRANGER 1 mode)                  |
| 1st RX ONLY part<br>MIDI ch 8 * OFF* | MIDI Channel 1-16<br>RX (Receive) Channel Only ON/OFF            |
| 2nd RX ONLY part<br>MIDI ch 9 * OFF* | MIDI Channel 1-16<br>RX (Receive) Channel Only ON/OFF            |
| MIDI CLOCK<br>RX/TX * ON*            | TX (Transmit) & RX (Receive) ON/OFF<br>MIDI CLOCK F8             |
| MIDI VOLUME CC 7<br>RX/TX * ON*      | TX (Transmit) & RX (Receive) ON/OFF<br>Volume Control Change 07  |

- \* MIDI CLOCK is to be ON when you wish to play other MIDI-equipped rhythm machines or sequencers at the same tempo with the E-20.
- \* MIDI VOLUME (MIDI Control Change 7) is a MIDI message that controls the volume.  
When using external MIDI-equipped devices (sequencers, synthesizers, etc.), the volume of each part of the E-20 is controlled by its MIDI Channel as well as the total volume of all parts.



To change the MIDI Channel of each part for transmitting and receiving MIDI data, press the MIDI button several times until the part you require appears in the display and then hold it when you find it.

Press the key in lower section of the keyboard (see Fig. below) which corresponds to the MIDI Channel you wish to select, 1-16, or press the key marked ON/OFF to turn data transmitting and receiving On or Off.

The display will indicate the change.

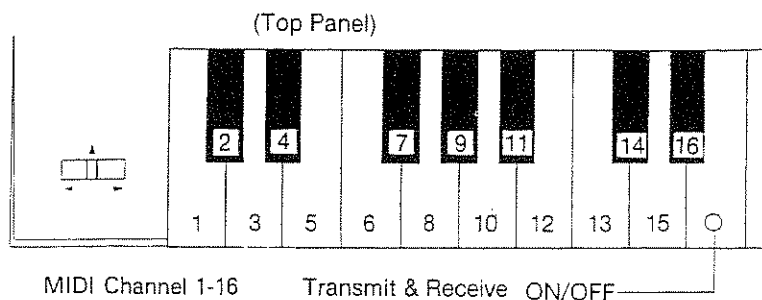

A few seconds after the MIDI button is released, the display will return to the Master Display.

\* The changes you make in MIDI functions will be erased when the instrument is switched off.

As was explained above, the E-20 delivers a lot of musical capability with ARRANGER, VARIATION, CHORD INTELLIGENCE and MELODY INTELLIGENCE.

You can also get an additional 2 parts (1st and 2nd RX ONLY parts which cannot be played with the E-20 alone) with 128 tones available for selection when the E-20 is controlled by external MIDI devices such as the MC/PR series sequencers. Then the E-20 will perform most 9-part orchestrations.

See MIDI IMPLEMENTATION CHART for details on the MIDI data which the E-20 can transmit and receive (recognize).

\* For additional information on advanced MIDI Control, see your Roland dealer.

# IF YOUR E-20 FAILS TO OPERATE:

- Make sure that the AC cord is firmly plugged into the AC socket on the rear panel. Also check that the AC wall outlet is not faulty. Plug in a lamp or radio to test the wall outlet.
- Be sure the ON/OFF switch (located on the rear of the top panel) is ON.
- In the event the instrument is still inoperable, your Roland technician or dealer is best qualified to provide you with competent service. Do not attempt any adjustments or repairs by yourself.
- When the display responds with a different indication from any explained in this manual, refer to "ERROR MESSAGES" on pages 66 & 68.

## < Reference >

The E-20 will always select the following features, when it is turned on (These are often called the Default settings):

Upper Tone — 11 ELEC PIANO 1  
Lower Tone — 42 STRING SECT2  
Bass Tone — 71 ACOU BASS 1  
Tone Balance of each section:  
(Upper 100)  
(Lower 80)  
(Accomp 75)  
(Bass 90)  
(Drums 90)  
Split — Off position  
Rhythm — 16 FUNK 2  
Tempo — 110  
Variation — Off position  
Arranger — Off, 2 position  
Memory — Off position  
Sync Start — Off position  
Chord Intelligence — Off position  
Melody Intelligence — Off position  
Reverb — On position  
Reverb Part Assign — default position (see REVERB PART ASSIGN)  
Reverb Type — Room 2  
Manual Drum — Off position  
Footswitch — Sustain mode  
Transpose — in C  
Master Tune — 442.0 Hz  
MIDI Channels — default positions (see MIDI CONTROL)

# MIDI IMPLEMENTATION CHART

| FUNCTION                |                                                                | TRANSMITTED                              | RECOGNIZED                             | REMARKS                                                                                         |
|-------------------------|----------------------------------------------------------------|------------------------------------------|----------------------------------------|-------------------------------------------------------------------------------------------------|
| <b>Basic</b>            | Default                                                        | 2—3—4—5—6<br>7—10                        | 2—3—4—5—6—7—10<br>8OFF—9OFF            | 2=BASS 6=ACCOMP2<br>3=LOWER 7=ACCOMP3<br>4=UPPER 8=1RX ONLY<br>5=ACCOMP1 9=2RX ONLY<br>10=DRUMS |
| <b>Channel</b>          | Changed                                                        | 1—16, OFF                                | 1—16, OFF                              |                                                                                                 |
| <b>Mode</b>             | Default<br>Messages<br>Altered                                 | MODE 3<br>×<br>*****                     | MODE 3<br>×<br>×                       |                                                                                                 |
| <b>Note Number</b>      | True voice                                                     | 18—102<br>*****                          | 0—127<br>12—108                        |                                                                                                 |
| <b>Velocity</b>         | Note ON<br>Note OFF                                            | ○<br>○                                   | ○<br>×                                 |                                                                                                 |
| <b>After Touch</b>      | Key's<br>Ch's                                                  | ×<br>×                                   | ×<br>×                                 |                                                                                                 |
| <b>Pitch Bender</b>     |                                                                | ○                                        | ○                                      |                                                                                                 |
| <b>Control Change</b>   | 1<br>7<br>10<br>11<br>12—63<br>64<br>65—120<br>121             | ○<br>○ *<br>×<br>×<br>×<br>○ *<br>×<br>× | ○<br>○ *<br>○<br>○<br>×<br>○<br>×<br>○ | MODULATION<br>PART VOLUME<br>PAN POT<br>EXPRESSION<br><br>HOLD 1<br><br>RESET ALL CONTROLLERS   |
| <b>Program Change</b>   | True #                                                         | 0—63<br>*****                            | 0—127<br>0—127                         | RHYTHM PATTERN<br>0—83                                                                          |
| <b>System Exclusive</b> |                                                                | ○                                        | ○                                      |                                                                                                 |
| <b>System Common</b>    | : Song Pos.<br>: Song Sel<br>: Tune                            | ×<br>×<br>×                              | ×<br>×<br>×                            |                                                                                                 |
| <b>System Real Time</b> | : Clock<br>: Commands                                          | ○ *<br>○                                 | ○ *<br>○                               |                                                                                                 |
| <b>Aux Messages</b>     | : Local ON/OFF<br>: All Notes OFF<br>: Active Sense<br>: Reset | ×<br>×<br>×<br>×                         | ×<br>○ (123—127)<br>×<br>×             |                                                                                                 |
| <b>Notes</b>            | * can be set ○ or × MANUALLY                                   |                                          |                                        |                                                                                                 |

**Mode 1** : OMNI ON, POLY  
**Mode 3** : OMNI OFF, POLY

**Mode 2** : OMNI ON, MONO  
**Mode 4** : OMNI OFF, MONO

○ : Yes  
× : No

# SPECIFICATIONS

|                              |                                                                                                                                                                                        |
|------------------------------|----------------------------------------------------------------------------------------------------------------------------------------------------------------------------------------|
| <b>Keyboard:</b>             | 61 keys velocity sensitive                                                                                                                                                             |
| <b>Sound Source System:</b>  | LA Digital Synthesis                                                                                                                                                                   |
| <b>Built-in Effect:</b>      | Digital Reverb (8 types: Hall 1-2, etc.)                                                                                                                                               |
| <b>Panel Switch/Control:</b> |                                                                                                                                                                                        |
| <b>VOLUME:</b>               | Master Volume Control                                                                                                                                                                  |
| <b>BALANCE:</b>              | Upper, Lower, Accomp, Bass, Drum.                                                                                                                                                      |
| <b>FUNCTION:</b>             | Multi Function Footswitch (6 modes)<br>MIDI—9 instrumental sections, MIDI channel changeable<br>Transpose/Master Tune/Pitch Bend Range                                                 |
| <b>COMPOSER:</b>             | Record and Play (Upper and/or Lower Track)<br>3 songs (1 song: approx. 200 measures)                                                                                                   |
| <b>ARRANGER:</b>             | On/Off, Chord Intelligence, Memory, Sync Start                                                                                                                                         |
| <b>RHYTHM SECTION:</b>       | Bank 1-4, Number 1-8, Card, Tempo Slider, Variation for each rhythm.                                                                                                                   |
| <b>TONE SELECT:</b>          | Upper, Lower, Bass, Bank 1-8, Number 1-8.                                                                                                                                              |
| <b>MEMORY CARD:</b>          | From Card, To Card                                                                                                                                                                     |
| <b>REVERB:</b>               | On/Off, Part Assign (Yes/No), Type (8 types)                                                                                                                                           |
| <b>Real Time Switches:</b>   | Manual Drum, Split 1/2, Fill-in (To Variation, To Original), Intro/Ending, Arranger 1/2, Start/Stop, Melody Intelligence, User Program 1-8, Write, Demo, Pitch Bender/Modulation lever |
| <b>Display:</b>              | 16 characters × 2 lines (LCD back lit)                                                                                                                                                 |
| <b>Rear Panel Terminal:</b>  | AUX IN (Right, Left/Mono)<br>AUX OUT (Right/Mono, Left)<br>MIDI (OUT, THRU, IN)<br>Pedal Footswitch                                                                                    |

**Front Panel Terminal:** Headphones

**Built-in Speakers:** 120 mm × 2

**Power Amplifier:** 5 W × 2 (stereo)

**Dimensions:** 1023 mm (W) × 100 mm (H) × 330 mm (D)

**Weight:** 12 kg

**Options:** Stereo Expression Pedal (FV-200)  
Keyboard Stand (KS-8)  
Memory Card (M-256D, M-256E)  
Style Card (RXN-E20)

# PANEL SETTING MEMO

Please write your original panel settings on the memo below so you will have written record of them.

SONG TITLE:

DATE:

|         | TONE NUMBER | VOLUME BALANCE | ON/OFF   | REVERB   |
|---------|-------------|----------------|----------|----------|
| UPPER   |             |                | ON / OFF | YES / NO |
| LOWER   |             |                | ON / OFF | YES / NO |
| BASS    |             |                | ON / OFF | —        |
| DRUMS   |             |                | ON / OFF | YES / NO |
| ACCOMP. |             |                | ON / OFF | —        |

|                     |                                                                                                                      |
|---------------------|----------------------------------------------------------------------------------------------------------------------|
| SPLIT               | ON / OFF                                                                                                             |
| SPLIT               | 1 / 2                                                                                                                |
| VARIATION           | ON / OFF                                                                                                             |
| TEMPO               | ♩ =                                                                                                                  |
| ARRANGER            | 1 / 2                                                                                                                |
| CHORD INTELLIGENCE  | ON / OFF                                                                                                             |
| MEMORY              | ON / OFF                                                                                                             |
| SYNC START          | ON / OFF                                                                                                             |
| MELODY INTELLIGENCE | ON / OFF                                                                                                             |
| MANUAL DRUM         | ON / OFF                                                                                                             |
| FOOTSWITCH ASSIGN   | SUSTAIN    START/STOP    FILL-IN TO VARIATION<br>FILL-IN TO ORIGINAL    INTRO/ENDING<br>SPLIT ON/OFF    ARRANGER 1/2 |
| TRANSPOSE           | KEY in                                                                                                               |
| PITCH BENDER RANGE  | 1 , 2 , 3 , 4 , 5 , 6 , 7 , 8                                                                                        |
| REVERB EFFECT       | ON / OFF                                                                                                             |
| REVERB TYPE         | 1 , 2 , 3 , 4 , 5 , 6 , 7 , 8                                                                                        |

MODEL: ROLAND E-20 SYNTHESIZER

DATE: JUNE 1988  
VERSION: 1.00

# PANEL SETTING MEMO

Please write your original panel settings on the memo below so you will have written record of them.

SONG TITLE:

DATE:

|         | STONE NUMBER | VOLUME BALANCE | ON/OFF   | REVERB   |
|---------|--------------|----------------|----------|----------|
| UPPER   |              |                | ON / OFF | YES / NO |
| LOWER   |              |                | ON / OFF | YES / NO |
| BASS    |              |                | ON / OFF | —        |
| DRUMS   |              |                | ON / OFF | YES / NO |
| ACCOMP. |              |                | ON / OFF | —        |

|                     |                                                                                                          |
|---------------------|----------------------------------------------------------------------------------------------------------|
| SPLIT               | ON / OFF                                                                                                 |
| SPLIT               | 1 / 2                                                                                                    |
| VARIATION           | ON / OFF                                                                                                 |
| TEMPO               | J =                                                                                                      |
| ARRANGER            | 1 / 2                                                                                                    |
| CHORD INTELLIGENCE  | ON / OFF                                                                                                 |
| MEMORY              | ON / OFF                                                                                                 |
| SYNC START          | ON / OFF                                                                                                 |
| MELODY INTELLIGENCE | ON / OFF                                                                                                 |
| MANUAL DRUM         | ON / OFF                                                                                                 |
| FOOTSWITCH ASSIGN   | SUSTAIN START/STOP FILL-IN TO VARIATION<br>FILL-IN TO ORIGINAL INTRO/ENDING<br>SPLIT ON/OFF ARRANGER 1/2 |
| TRANSPOSE           | KEY in                                                                                                   |
| PITCH BENDER RANGE  | 1, 2, 3, 4, 5, 6, 7, 8                                                                                   |
| REVERB EFFECT       | ON / OFF                                                                                                 |
| REVERB TYPE         | 1, 2, 3, 4, 5, 6, 7, 8                                                                                   |

MODEL: ROLAND E-20 SYNTHESIZER

DATE: JUNE 1988

VERSION: 1.00

# PANEL SETTING MEMO

Please write your original panel settings on the memo below so you will have written record of them.

SONG TITLE:

DATE:

|         | STONE NUMBER | VOLUME BALANCE | ON/OFF   | REVERB   |
|---------|--------------|----------------|----------|----------|
| UPPER   |              |                | ON / OFF | YES / NO |
| LOWER   |              |                | ON / OFF | YES / NO |
| BASS    |              |                | ON / OFF | —        |
| DRUMS   |              |                | ON / OFF | YES / NO |
| ACCOMP. |              |                | ON / OFF | —        |

|                     |                                                                                                          |
|---------------------|----------------------------------------------------------------------------------------------------------|
| SPLIT               | ON / OFF                                                                                                 |
| SPLIT               | 1 / 2                                                                                                    |
| VARIATION           | ON / OFF                                                                                                 |
| TEMPO               | ♩ =                                                                                                      |
| ARRANGER            | 1 / 2                                                                                                    |
| CHORD INTELLIGENCE  | ON / OFF                                                                                                 |
| MEMORY              | ON / OFF                                                                                                 |
| SYNC START          | ON / OFF                                                                                                 |
| MELODY INTELLIGENCE | ON / OFF                                                                                                 |
| MANUAL DRUM         | ON / OFF                                                                                                 |
| FOOTSWITCH ASSIGN   | SUSTAIN START/STOP FILL-IN TO VARIATION<br>FILL-IN TO ORIGINAL INTRO/ENDING<br>SPLIT ON/OFF ARRANGER 1/2 |
| TRANSPOSE           | KEY in                                                                                                   |
| PITCH BENDER RANGE  | 1, 2, 3, 4, 5, 6, 7, 8                                                                                   |
| REVERB EFFECT       | ON / OFF                                                                                                 |
| REVERB TYPE         | 1, 2, 3, 4, 5, 6, 7, 8                                                                                   |

MODEL: ROLAND E-20 SYNTHESIZER

DATE: JUNE 1988  
VERSION: 1.00





 Roland®

10924

UPC 10924



10924

E-20

Printed in Italy by F. & A. Anelli Augusta

89-7-E-20-OM

 Roland