

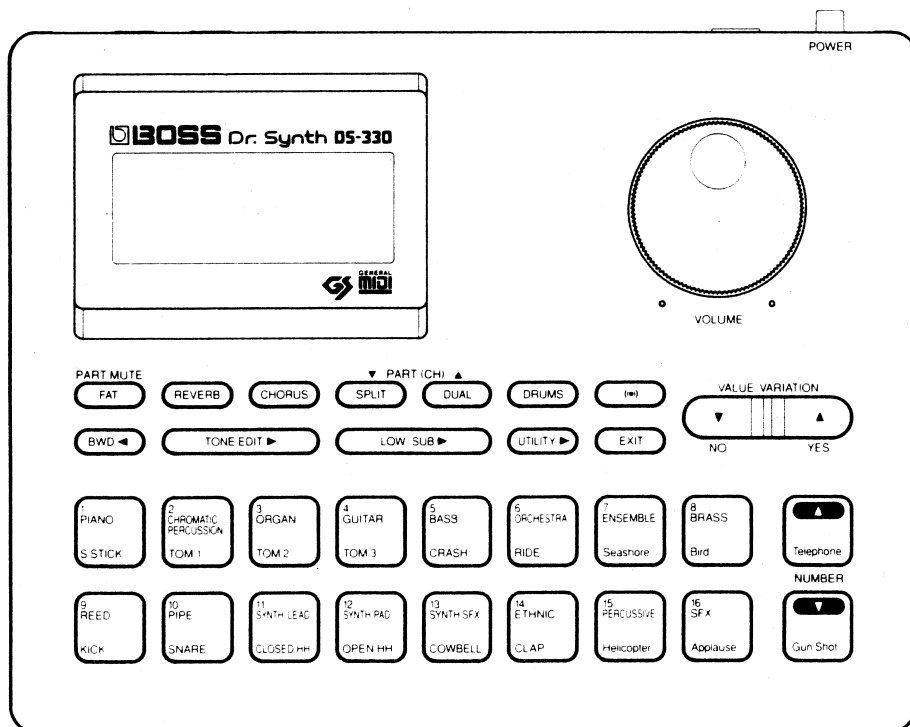

Dr. Synth DS-330

Owner's Manual



For Nordic Countries

Apparatus containing Lithium batteries

ADVARSEL!

Lithiumbatteri – Eksplosionsfare ved fejlagtig håndtering.
Udskiftning må kun ske med batteri af samme fabrikat og type.
Levér det brugte batteri tilbage til leverandøren.

VARNING!

Explosionsfara vid felaktigt batteribyte.
Använd samma batterityp eller en ekvivalent typ som rekommenderas av apparattillverkaren.
Kassera använt batteri enligt fabrikantens instruktion.

ADVARSEL!

Lithiumbatteri – Eksplosjonsfare.
Ved utskifting benyttes kun batteri som anbefalt av apparatfabrikanten.
Brukt batteri returneres apparatleverandøren.

VAROITUS!

Paristo voi räjähtää, jos se on virheellisesti asennettu.
Vaihda paristo ainoastaan laitevalmistajan suosittelemaan tyyppiin. Hävitä käytetty paristo valmistajan ohjeiden mukaisesti.

For Germany

Bescheinigung des Herstellers/Importeurs

Hiermit wird bescheinigt, daß der/die/das

DR. SYNTH DS-330

(Gerät. Typ. Bezeichnung)

in Übereinstimmung mit den Bestimmungen der

Amtsbl. Vfg 1046/1984

(Amtsblattverfügung)

funk-entstört ist.

Der Deutschen Bundespost wurde das Inverkehrbringen dieses Gerätes angezeigt und die Berechtigung zur Überprüfung der Serie auf Einhaltung der Bestimmungen eingeräumt.

Roland Corporation Osaka/Japan

Name des Herstellers/Importeurs

For the USA

RADIO AND TELEVISION INTERFERENCE

WARNING — This equipment has been verified to comply with the limits for a Class B computing device pursuant to Subpart J of Part 15 of FCC rules. Operation with non-certified or non-verified equipment is likely to result in interference to radio and TV reception.

The equipment described in this manual generates and uses radio frequency energy. If it is not installed and used properly, that is, in strict accordance with our instructions, it may cause interference with radio and television reception. This equipment has been tested and found to comply with the limits for a Class B computing device in accordance with the specifications in Subpart J, of Part 15, of FCC Rules. These rules are designed to provide reasonable protection against such a interference in a residential installation. However, there is no guarantee that the interference will not occur in a particular installation. If this equipment does cause interference to radio or television reception, which can be determined by turning the equipment on and off, the user is encouraged to try to correct the interference by the following measure:

- Disconnect other devices and their input/output cables one at a time. If the interference stops, it is caused by either the other device or its I/O cable. These devices usually require Roland designated shielded I/O cables. For Roland devices you can obtain the proper shielded cable from your dealer. For non-Roland devices, contact the manufacturer or dealer for assistance.
- If your equipment does cause interference to radio or television reception, you can try to correct the interference by using one or more of the following measures:
 - Turn the TV or radio antenna until the interference stops.
 - Move the equipment to one side or the other of the TV or radio.
 - Move the equipment farther away from the TV or radio.
 - Plug the equipment into an outlet that is on a different circuit than the TV or radio. (That is, make certain the equipment and the radio or television set are on circuits controlled by different circuit breakers or fuses.)
 - Consider installing a rooftop television antenna with coaxial cable lead-in between the antenna and TV. If necessary, you should consult your dealer or an experienced radio/television technician for additional suggestions. You may find helpful the following booklet prepared by the Federal Communications Commission: "How to Identify and Resolve Radio — TV Interference Problems".

This booklet is available from the U.S. Government Printing Office, Washington, D.C. 20402. Stock No. 004-000-00345-4

For Canada

CLASS B

NOTICE

This digital apparatus does not exceed the Class B limits for radio noise emissions set out in the Radio Interference Regulations of the Canadian Department of Communications.

CLASSE B

AVIS

Cet appareil numérique ne dépasse pas les limites de la classe B au niveau des émissions de bruits radioélectriques fixés dans le Règlement des signaux parasites par le ministère canadien des Communications.

■ Before You Begin...

We'd like to take a moment to thank you for purchasing the BOSS DS-330 "Dr. Synth".

Please read your manual thoroughly before using the DS-330. It will help you get the most out of the unit and allow you to enjoy years of trouble-free service.

■ Main Features

- Buttons for selecting Tones are laid out on the front panel. Just hook up a MIDI keyboard to use the DS-330 as an external sound module.
- Easy Tone editing.
- Contains lots of high-quality sounds and drum sets.
- Reverb and Chorus effects to make it sound like you're playing in a spacious concert hall.
- A 16-part multi-timbral sound module. Ideal for sequencers and computer music.
- The Dr. Synth sound module uses the GS Format developed by Roland.
If you write song data for use on one GS Format sound module, you'll be able to play it back in the same way on any other GS Format sound module.

GENERAL MIDI



The sound sources in this unit conform to the General MIDI System specifications (General MIDI System Level 1). This means that General MIDI Scores (music data created for use with a General MIDI System device) can be played on this unit as well.

GS



The sound sources in this unit conform to Roland's GS Format. This assures that any music data created for use with a GS Format sound generating device can be faithfully reproduced on this unit.

1992 BOSS CORPORATION

All rights reserved. No part of this publication may be reproduced in any form without the written permission of BOSS CORPORATION.

Table of Contents

■ Main Features	3
■ Table of Contents	4
■ Precautions for Use	6
■ Using the DS-330 Dr.Synth and How to Read	
This Manual	7
● Switching Between Single and Multi Mode	7
● How to Use This Manual	8
● About the Symbols in the Text	8
■ Part Names and Description	9
■ Making the Connections	10
● MIDI Connections	10
<<Connecting a MIDI Keyboard>>	10
<<Connecting a Roland SB-55 Sound Brush	
(sequencer) >>	10
● Output Connections	10
● Using Headphones	11
● AC Adaptor	11
■ Powering Up	12
■ Listening to ROM Play	13
■ Adjusting the Volume	14
■ Listening to the Various Tones	15
● Switching Tones	16
<<Switching Banks>>	16
<<Switching Numbers>>	17
● Registering Tones	17
● Switching Between Variations	18
<<How to Switch Between Variations>>	18

Single Mode/Play

■ Enhancing Sounds with FAT	20
■ Turning On Reverb and Chorus	21
● Reverb On/Off	21
● Chorus On/Off	21
■ Split/Dual	22
● What is Split/Dual?	22
● Turning Split and Dual On and Off	24
<<How to: Turn Split On and Off>>	24
<<How to: Turn Dual On and Off>>	24
● Various Settings for Split and Dual	24
● Functions You Can Set	25
<<Split Settings>>	25
<<Dual Settings>>	26
■ Playing the Drum Sets	27
● How to Play a Drum Set	27
<<Playing the Drums Using the Dr. Synth>>	27
<<Playing the Drums Using a MIDI Keyboard>>	27
● Switching Between Drum Sets	28

Single Mode/Edit

■ Changing the Way the Sounds Play in Each	
Tone and Drum Set	30
● Making Settings	30
● Functions You Can Set	31
■ Setting the Utility Features	39
● How to Make Settings	39
● Functions You Can Set	40

Multi Mode/Play

■ Selecting a Tone for Each Part	46
● Parts and Tones	46
● Switching Tones for Each Part	47
■ Playing the Drum Sets	48
● Drum Sets and Drum Parts	48
● How to Play the Drum Sounds	48
● Assigning the Drum Set to a Different Part	49
■ Adding Reverb and Chorus	50
● Reverb On/Off	50
● Chorus On/Off	50
■ Part Mute	51

Multi Mode/Edit

■ Changing the Level and Effects Level of	
Each Part	54
● How to Make Settings	54
● Functions You Can Set	54
■ Master Level and Effect Settings	56
● How to Make Settings	56
● Functions You Can Set	56
■ Setting the Utility Features	59
● How to Make Settings	59
● Functions You Can Set	59

MIDI Applications

□ About MIDI	64
1. Exchanging MIDI Messages	64
2. MIDI Messages Handled by the Dr. Synth	65
■ Switching Tones and Drums Sets With an	
External MIDI Device	67
● Switching Tones with an External MIDI Device	67
● Switching Drum Sets with an External MIDI Device	67
● Switching Variations with an External MIDI Device	68
■ Transmitting Data via MIDI	68
◆ Sending Data (Bulk Dump)	68
◆ Receiving Data (Bulk Load)	72

Data

■ The GM System and GS Format	76
■ About Tone Variations	77
■ Correspondence with Program Change Messages	80
■ If You Think There Might Be a Problem	81
■ Error Messages	82
■ Returning to Factory Default Settings (Initialization)	83
■ Parameter Table	84
■ Tone Table	87
■ Drum Set Table	90
■ Drum Pad Table	91
About Roland SysEx Messages	92
MIDI Implementation	94
MIDI Implementation Chart	106
■ How to Read the MIDI Implementation Chart ..	107
■ Specifications	108
■ Index	109

■ Precautions for Use

Be sure to use only the adaptor supplied with the unit. Use of any other adaptor could result in damage, malfunction, or electric shock.

POWER SUPPLY

- When making any connections with other devices, always turn off the power to all equipment first; this will help prevent damage or malfunction.
- Do not use this unit on the same power circuit with any device that will generate line noise, such as a motor or variable lighting system.
- The power supply required for this unit is shown on its nameplate. Ensure that the line voltage of your installation meets this requirement.
- Avoid damaging the power cord; do not step on it, place heavy objects on it etc.
- When disconnecting the AC adaptor from the outlet, grasp the plug itself; never pull on the cord.
- If the unit is to remain unused for a long period of time, unplug the power cord.

PLACEMENT

- Do not subject the unit to temperature extremes (eg. direct sunlight in an enclosed vehicle). Avoid using or storing the unit in dusty or humid areas or areas that are subject to high vibration levels.
- Using the unit near power amplifiers (or other equipment containing large transformers) may induce hum.
- This unit may interfere with radio and television reception. Do not use this unit in the vicinity of such receivers.
- Do not expose this unit to temperature extremes (eg. direct sunlight in an enclosed vehicle can deform or discolor the unit) or install it near devices that radiate heat.

MAINTENANCE

- For everyday cleaning wipe the unit with a soft, dry cloth (or one that has been slightly dampened with water). To remove stubborn dirt, use a mild neutral detergent. Afterwards, be sure to wipe the unit thoroughly with a soft, dry cloth.
- Never use benzene, thinners, alcohol or solvents of any kind, to avoid the risk of discoloration and/or deformation.

ADDITIONAL PRECAUTIONS

- Protect the unit from strong impact.
- Do not allow objects or liquids of any kind to penetrate the unit. In the event of such an occurrence, discontinue use immediately. Contact qualified service personnel as soon as possible.
- Never strike or apply strong pressure to the display.
- A small amount of heat will radiate from the unit, and thus should be considered normal.
- Before using the unit in a foreign country, consult with qualified service personnel.
- Should a malfunction occur (or if you suspect there is a problem) discontinue use immediately. Contact qualified service personnel as soon as possible.
- To prevent the risk of electric shock, do not open the unit or its AC adaptor.

MEMORY BACKUP

- The unit contains a battery which maintains the contents of memory while the main power is off. The expected life of this battery is 3 years or more. However, to avoid the unexpected loss of memory data, it is strongly recommended that you change the battery every 3 years. Please be aware that the actual life of the battery will depend on the physical environment (especially temperature) in which the unit is used. When it is time to change the battery, consult with qualified service personnel.
- When the battery becomes weak the following message will appear in the display:

[Battery Low!]

- However, by that time the contents of memory may have already been lost.
- Please be aware that the contents of memory may at times be lost; when the unit is sent for repairs or when by some chance a malfunction has occurred. Important data should be stored sequencer, or written down on paper. During repairs, due care is taken to avoid the loss of data. However, in certain cases, (such as when circuitry related to memory itself is out of order) we regret that it may be impossible to restore the data.

■ Using the DS-330 Dr. Synth and How to Read This Manual

The DS-330 contains two different operating modes: Single mode and Multi mode. The manual too is divided along these lines. Select the mode best suited for your application and start reading from there.

- [SINGLE Mode]** Use this mode when you wish to use the Dr. Synth as an external sound module connected to a MIDI keyboard. In this mode only the messages on one specified MIDI channel are received.
- [MULTI Mode]** Select this mode when you wish to use the Dr. Synth as a sound module connected to a sequencer in a desktop music system, or as a sound module for playing in the GS Format. In this mode multiple channels of MIDI messages sent from an external MIDI device are received.

● Switching Between Single and Multi Mode

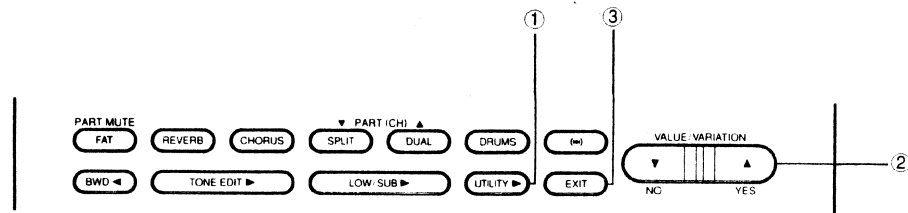

- ① When you press **UTILITY**, a variety of setting options will be displayed on the screen. Continue pressing **UTILITY** until you see a setting display like the one shown below.
- * If you go past it, just press **BWD** to back up.

[SINGLE Mode]

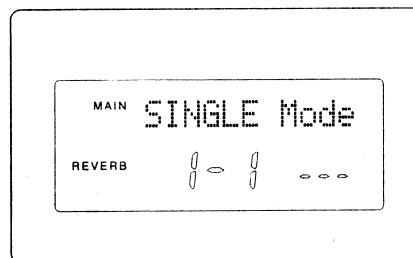

[MULTI Mode]

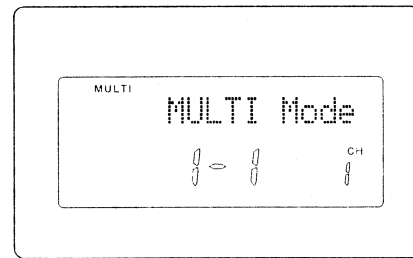

The current mode (SINGLE or MULTI) will be displayed.

- ② Press **VALUE** **▲** **▼** to change this setting.
- ③ Press **EXIT** to return to the previous screen.

●How to Use This Manual

The material that you should read in this manual will depend on the mode setting. Select the desired mode, then read the following procedure.

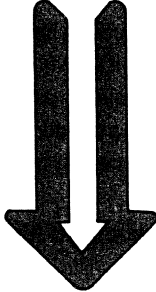
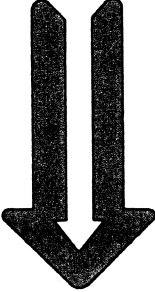
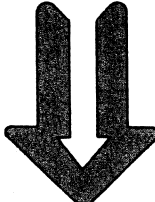
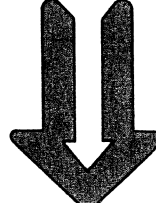
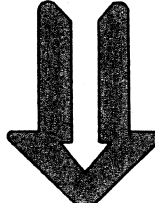
	[SINGLE Mode]	[MULTI Mode]
■ Main Features		
■ Table of Contents		
■ Precautions for Use		
■ Using the DS-330 Dr.Synth and How to Read This Manual		
■ Part Names and Description		
■ Making the Connections		
■ Powering Up		
■ Listening to ROM Play		
■ Listening to the Various Tones		
Single Mode/Play		
Single Mode/Edit		
Multi Mode/Play		
Multi Mode/Edit		
MIDI Applications		
Data		

●About the Symbols in the Text

- ◇ Letters or numbers surrounded by a represent front panel buttons. For example, FAT stands for the Fat button.
- ◇ When you see something like VALUE ▲▼, that means you can press either of the buttons as needed.
- ◇ (☞ page **) in the text means, “refer to this page for more information”.

Part Names and Description

●Front Panel

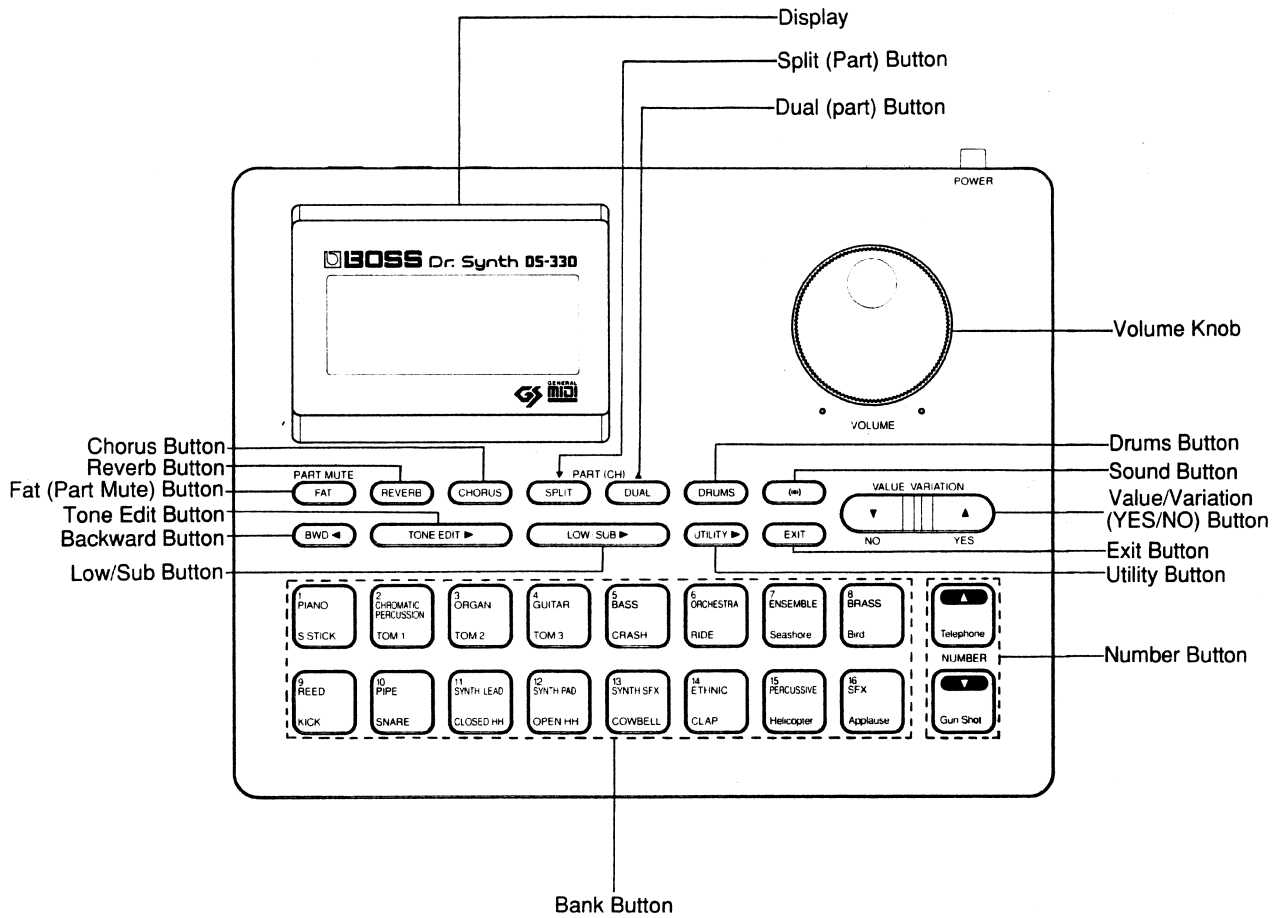

●Rear Panel

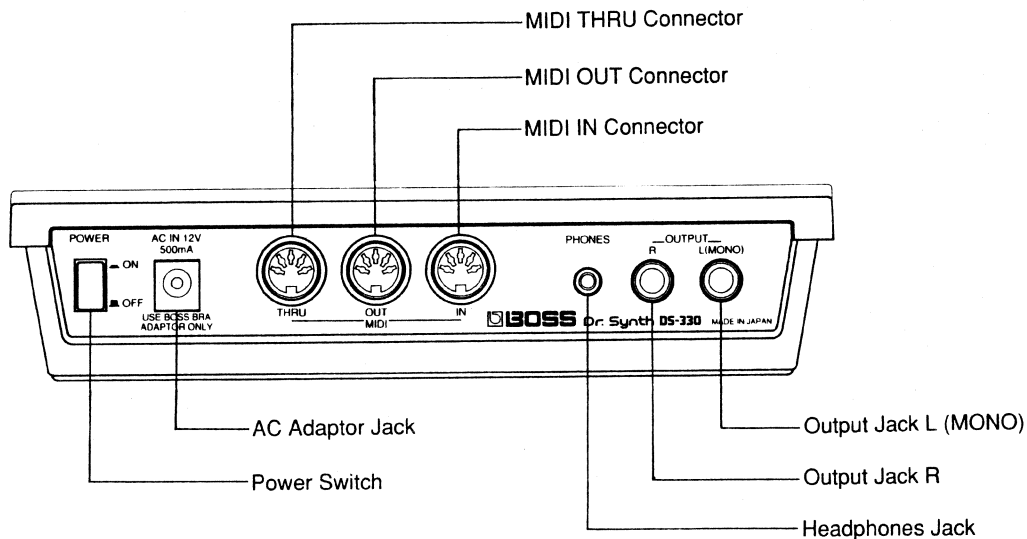

■ Making the Connections

The DS-330 does not come with its own keyboard or speakers, so you have to hook it up to a MIDI keyboard, amp and speakers in order to play it.

● MIDI Connections

<<Connecting a MIDI keyboard>>

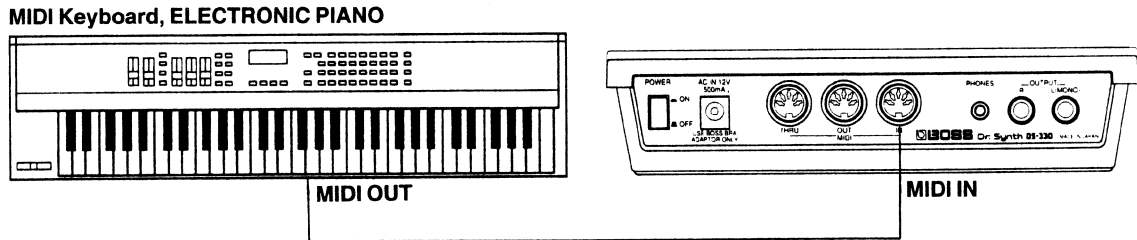

<<Connecting a Roland SB-55 Sound Brush (sequencer)>>

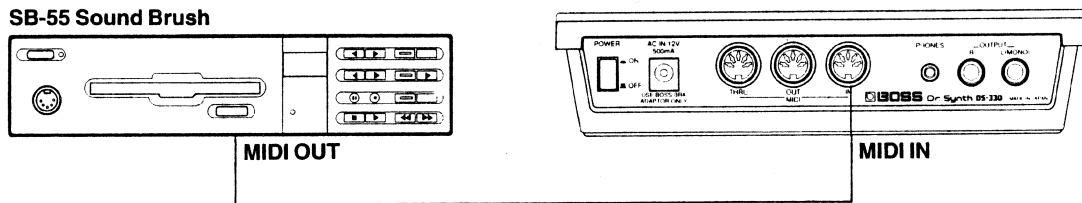

⇒ The Roland SB-55 Sound Brush is a MIDI sequencer that reads Standard MIDI Files. This lets you play song data recorded on the Sound Brush, or any other instrument for that matter, and enjoy music with all the fidelity of a CD.

● Output Connections

We highly recommend that you use a stereo playback system to get the most out of the DS-330, but if you are using a mono system, use the jack marked L(MONO).

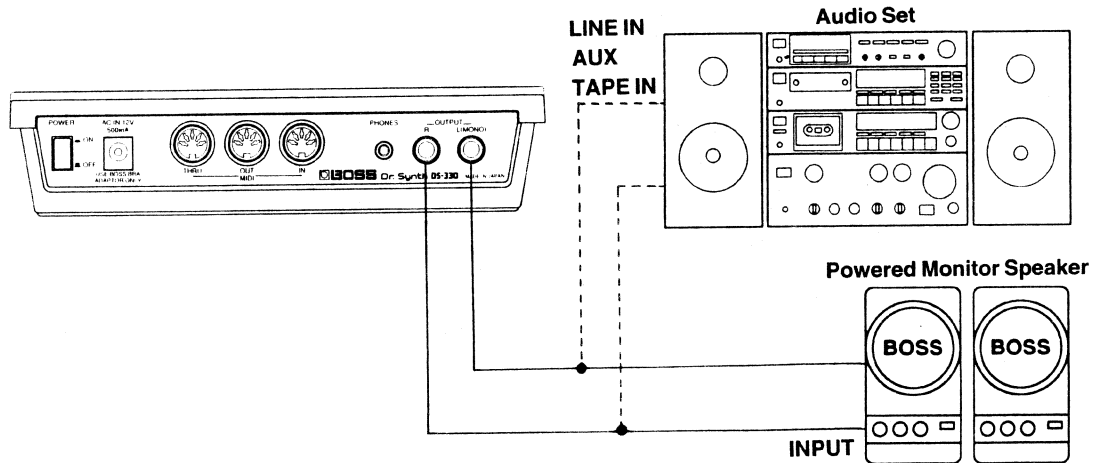

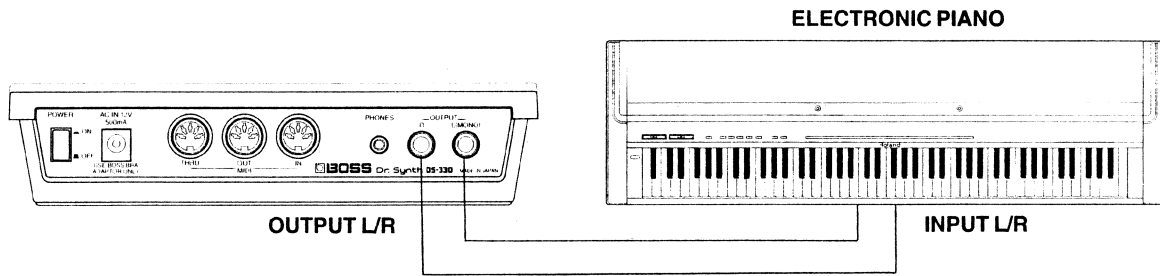

●Using Headphones

Use headphones with an impedance of 8 to 150 ohms. Even when you have the headphones plugged in, sound will be output from the other jacks.

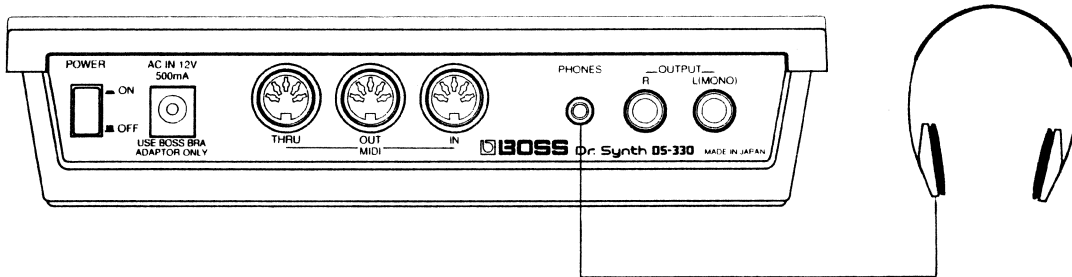

●AC Adaptor

Connect the AC adaptor to the adaptor jack on the rear panel and then the other end to an AC outlet.

Note: Use only the AC adaptor supplied with your DS-330. Use of other adaptors could result in damage, malfunction or electric shock.

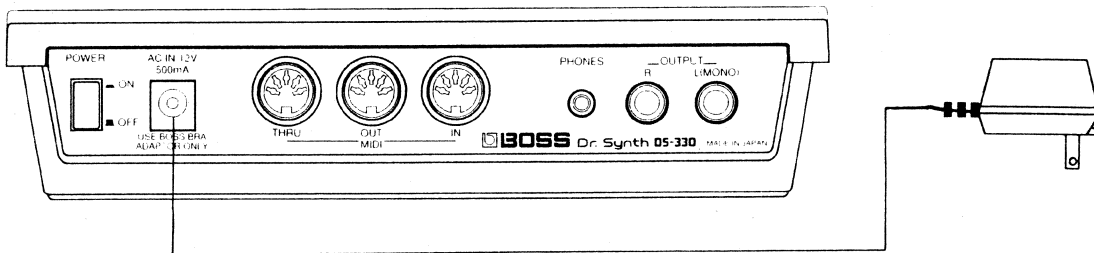

■ Powering Up

- ① Before turning on the power, make sure of the following:
 - ◇ Make sure all peripheral devices are correctly hooked up to the Dr. Synth.
 - ◇ The amp volume should be turned down.
- ② Turn on the power for the Dr. Synth and connected MIDI devices.
You will see the following display:

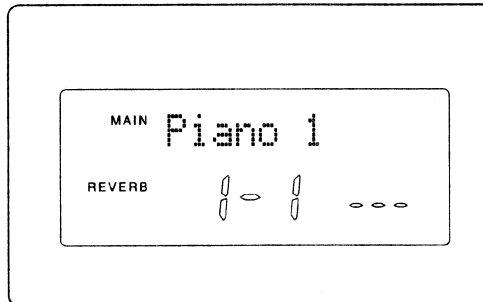

- * When you power up, the display will be the same as when you last turned off the DS-330.
- * The display may be difficult to read depending on the location and lighting conditions. If so, adjust the LCD contrast (see page 62).

- ③ Turn on the power to the output devices.
Turn the amp up to a suitable volume.
Note: You can damage your speakers if you turn the volume up too high. Standard audio speakers are not as rugged as speakers made specifically for musical instruments.

<<Turning Off the Power>>

- ① Before turning off the power, check the following:
 - ◇ Turn down the amp volume.
- ② Turn off the devices in the following order:
Output devices → Dr. Synth and MIDI devices

■ Listening to ROM Play

The Dr. Synth has a ready-made demo song stored in memory that shows off the capabilities of the multi-timbral sound source.

Playback of this demo song is called ROM Play.

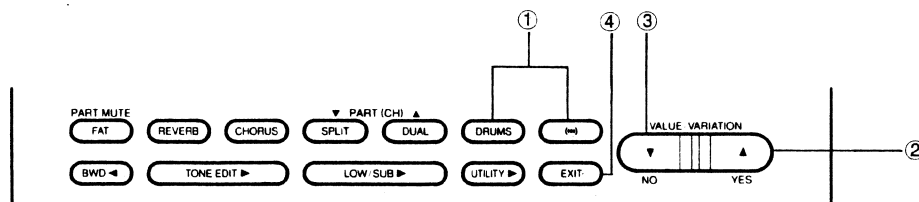

- ① Turn on the power while holding down the **DRUMS** and **(●)** buttons.
- ② Press the **YES** button to start play.
- ③ Press the **NO** button to interrupt play.
- ④ To return to regular play, press the **EXIT** button.

* **The performance data of the demo song is not output through the MIDI OUT connector, and data cannot be received by the MIDI IN connector during playback.**

<ROM Play Composer Profile>

Mitsuru Sakaue

Mitsuru Sakaue began composing and doing arrangements for commercials and videos while still in school. In particular, his studio work earned for him a solid reputation. Currently, as a chief producer within idecs, Inc., he produces commercial music and jingles for FM stations. His range of activity is broad, and includes his work as an instructor and expert on musical instruments/computer music for the Roland Learning Center (Japan), as well as for other schools. In addition, he has had numerous other opportunities for displaying his talents well while serving as demonstrator/product specialist for Roland.

* **Warning: All rights reserved. Unauthorized use of this material is a violation of applicable laws.**

■ Adjusting the Volume

Adjust the volume to a suitable level with the volume knob. Clockwise rotation increases the volume and counterclockwise rotation decreases it.

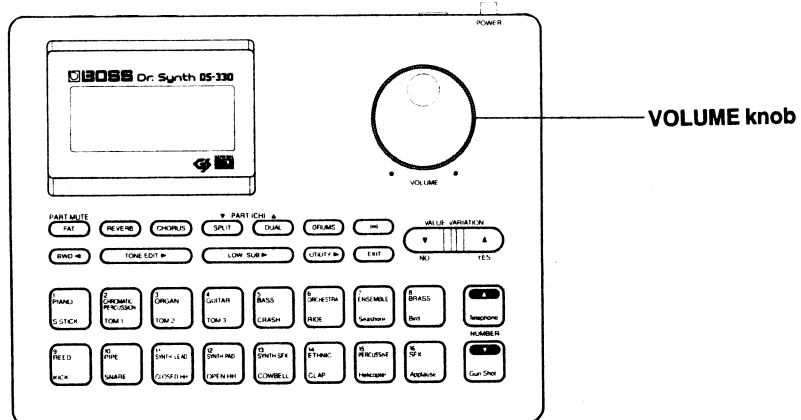

■ Listening to the Various Tones

The Dr. Synth has a variety of on-board sounds, from piano, organ and guitar (of course), to bird songs and ringing telephones. These sounds are called “Tones”.

There are 128 different Tones in the Dr. Synth, organized into 16 Banks with 8 Numbers in each:

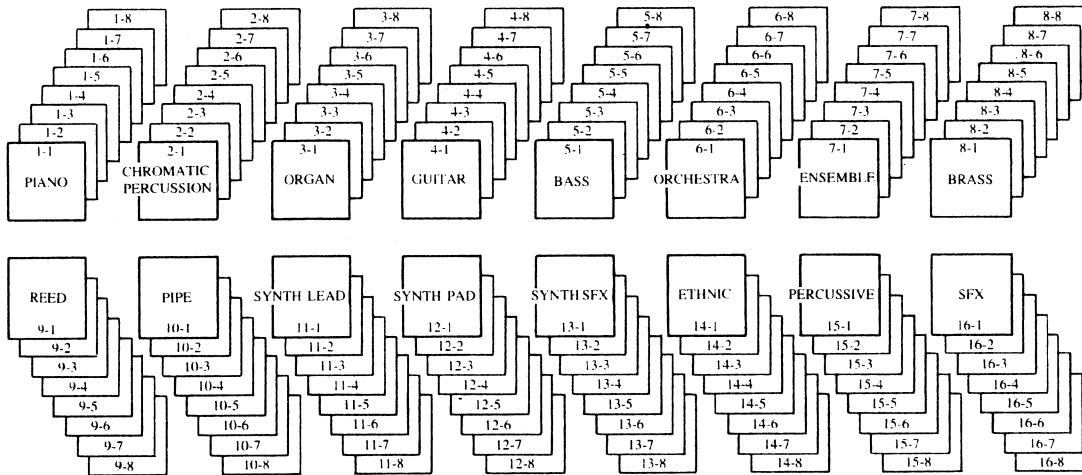

- ⇒ See “Tone Table” (☞ page 87) for the Tone types.
- ⇒ In addition to the standard Tones, the Dr. Synth also comes with percussion sounds combined into an assortment of drum sets. For more information on this, see “Playing the Drum Sets” (☞ page 27).

“Voice Ranges”

Some Tones may not be playable above (or below) certain notes. This is because each Tone is set up to conform to the actual playable range of the corresponding acoustic instrument. We hope you’ll give some thought to the way the actual instruments are played (and their characteristics) when writing parts for them.

●Switching Tones

Patches are selected using a combination of a Bank and a Number. In the display, you'll see both the tone name and the combined Bank/Number.

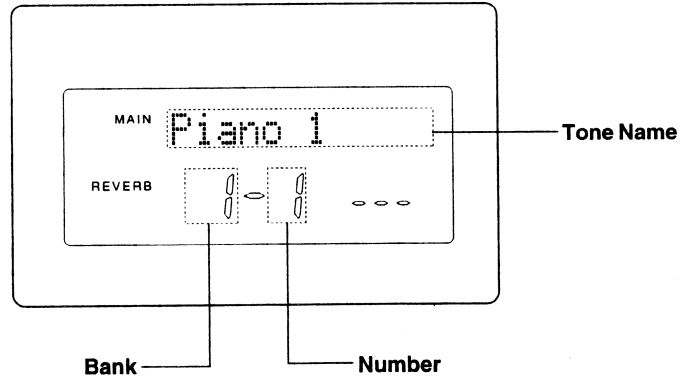

Try switching a few Tones and playing them using the connected MIDI keyboard. Or, if you aren't hooked up to a keyboard, just press the  button to hear the currently selected patch.



<<Switching Banks>>

Just press a Bank button to switch to that Bank. Pressing a Bank button recalls one of the eight Tones in that Bank that has been previously "registered".

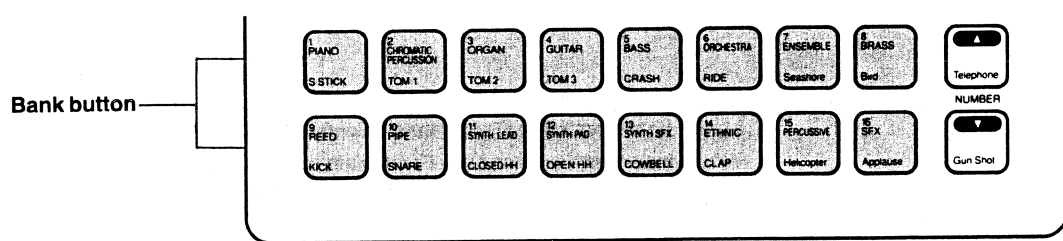
* **The registered Tone is the one that will be selected every time you switch to that Bank.**



<<Switching Numbers>>

Select a Tone using the Number buttons. Whenever you do so, the Number displayed in the screen will flash to indicate that the current Number is different from the registered one for that Bank. Each press of NUMBER   changes the Number by one.

This Tone selection is only temporary: if you switch to a different Bank and then return again, the registered Tone for that Bank will be recalled, not the one you just selected.

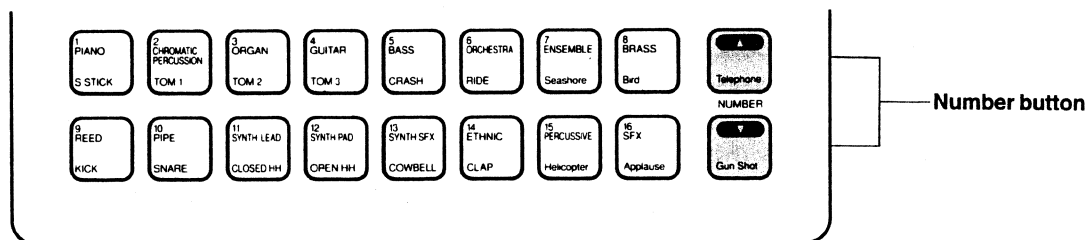



Let's try selecting and playing a few different Tones using the Bank and Number buttons.

* If you wish to switch Tones from a MIDI keyboard, refer to the section "Switching Tones With External MIDI Devices" (page 67).

●Registering Tones

You can register a Tone (Number) for each Bank. This lets you switch to a registered Tone (Number) just by selecting the appropriate Bank.

* **The Tone must be in the Bank to which you register it.**



- ① Select a Bank with the Bank button.
- ② Switch to the Tone (Number) you wish to register using the NUMBER   buttons.
- ③ Press the same Bank button you selected in Step ① again.
The Number in the display will stop flashing and the Tone (Number) is now registered.

You can register different Tones to the same Bank button in Single and Multi modes. As a matter of fact, in Multi mode you can register a Tone to a Bank button for each Part.

●Switching Between Variations

You can select from 128 different Tones using the Bank and Number buttons; these are called the "Capital" Tones. Some of the Capital Tones also have "Variations", Tones that are similar to the Capitals but with slightly different nuances. Some Capitals have several different Variations while others have none at all.



<<How to Switch Between Variations>>

When you select a Capital Tone that has a Variation, press the VARIATION  button to scroll through them. If there are several Variations available, each press of the VARIATION  button will select the next Variation. You can also use the VARIATION  button to back up to the previous selection.

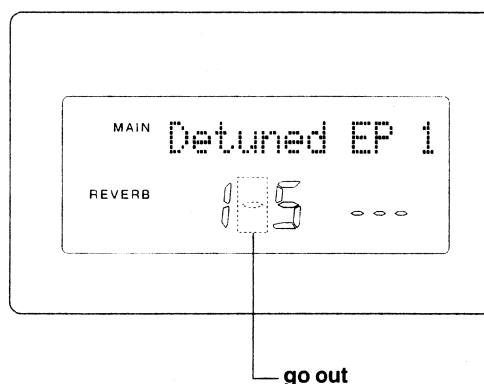
The display will show the name and Bank/Number of the Variation you have currently selected. A "-" in the Bank/Number display will disappear.



To return to the Capital Tone, press the VARIATION  button until you see a "-" in the Bank/Number display.

- * When you select a Variation, the effects (on/off) and other settings will be the same as for the Capital Tone from which you started.
- * If the selected Capital Tone has no Variations, pressing the VARIATION   buttons will have no effect.

- ⇒ See the "Tone Table" (☞ page 87) for more about the different kinds of Variations that are available.
- ⇒ In case a Variation is selected. Switching Tones differs slightly between the Single Mode and Multi Mode. For more information, see "About Tone Variations" (☞ page 77).

Single Mode/
Play

■ Enhancing Sounds with FAT

There is an effect you can use to “fatten” the sounds on the Dr. Synth, and appropriately enough, it’s called the FAT effect!

The FAT effect layers the original Tone with the same sound shifted down one octave and very slightly shifted in pitch; this makes the original sound seem thicker, warmer, “fatter”.

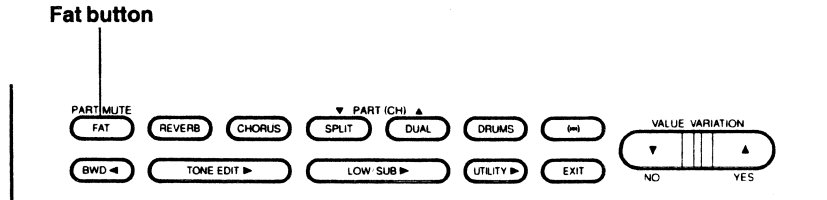

Press the **FAT** button to turn on the effect. When it’s on, you will see “FAT” in the display. Pressing the **FAT** button again turns off the effect.

The FAT on/off setting is stored with each Tone.

* **The FAT setting can be edited for each Tone. For how to do this, see the section called “FAT Settings” (page 31).**

■ Turning On Reverb and Chorus

If you like, you can add Reverb and Chorus to really change the ambience of a Tone.

● Reverb On/Off

Reverb adds a lingering decay sound to the Tone, as if you were hearing it played in a spacious concert hall.

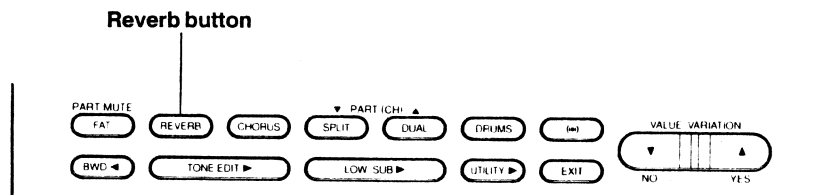

Press the **REVERB** button to turn Reverb on. When it's on, you will see "REVERB" in the display. Press the **REVERB** button again to turn off the effect.

The Reverb on/off setting is stored with each Tone.

- * **The Reverb setting can be edited for each Tone. For how to do this, see the section called "Reverb Settings" (see page 32).**
- * **If the Reverb Level is set to "0", you won't be able to turn the Reverb on (see page 32).**

● Chorus On/Off

Chorus adds a "thickening" effect to the sound. It's especially effective for organ and strings.

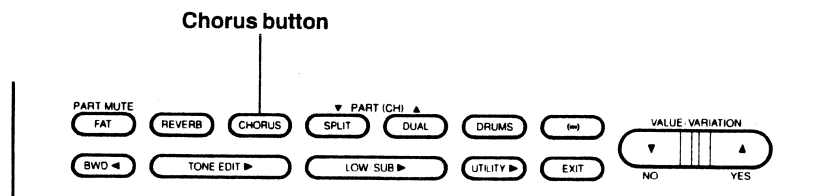

Press the **CHORUS** button to turn Chorus on. When it's on, you will see "CHORUS" in the display. Pressing the **CHORUS** button again turns off the effect.

The Chorus on/off setting is stored with each Tone.

- * **The Chorus setting can be edited for each Tone. For how to do this, see the section called "Chorus Settings" (see page 33).**
- * **If the Chorus Level is set to "0", you won't be able to turn the Chorus on (see page 33).**

■ Split/Dual

With Split and Dual, you'll be able to play two Tones at once. A variety of Tone combinations are then possible.

● What is Split/Dual?

On the Dr. Synth, <Split> and <Dual> give you the capability of playing two Tones at once.

We'll explain the difference between these two methods.

<Split>

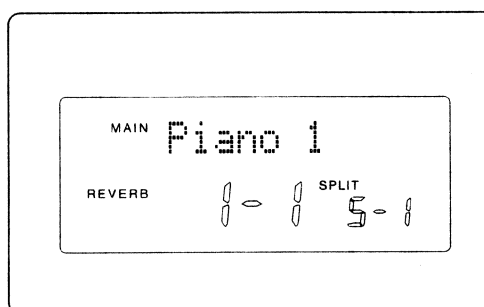

The keyboard is divided into two sections, upper and lower, and you can specify the key that will be the boundary between them (the "Split Point"). A different Tone can be assigned to the upper and lower keyboards.

When Split is selected, you will see the word "SPLIT" light up in the display.

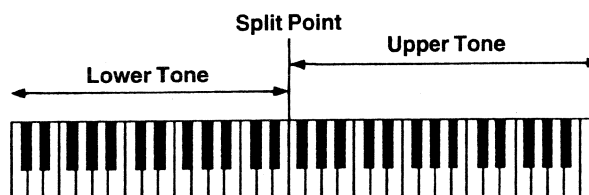

- * You can set a different Split Point for each Tone in any way you like. For more information about how to do this, see the section "Split Settings" (☞ page 25).
- * A Tone or Variation for the upper keyboard (the "Upper Tone") is assigned using the Bank and Number buttons. A Lower Tone is then assigned for each Upper Tone. For how to do this, see "Lower Tone" (☞ page 25).

* **The Lower Tone selected in Split is played with the following settings.**

[Tone Level] The Tone Level setting for each Tone is ignored, and the volume is set according to "Lower Tone Level" (☞ page 26).

[FAT] FAT effect cannot be applied to the Lower Tone.

[Reverb: Type/Time/Delay Feedback]

[Chorus: Delay/Rate/Depth/Feedback]

Same as settings for the Upper Tone.

* **Reverb and Chorus on/off and level settings will be the same as settings for that Tone.**

[Other settings that can be made for each tone]

Same as the settings for that Tone.

For a more detailed explanation, see the section "Changing the way the Sounds Play in Each tone and Drum Set" (☞ page 30).

<Dual>

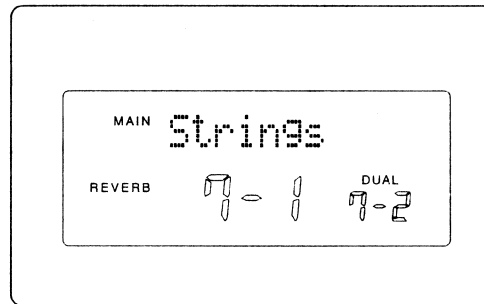

This lets you layer Tones together, i.e. assign two Tones to cover the entire keyboard. When Dual is selected, you will see the word "DUAL" light up in the display.

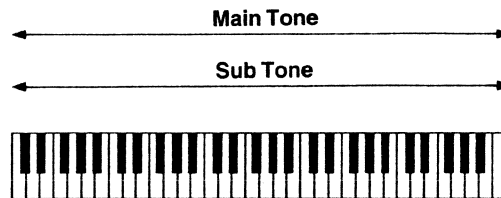

* **The two Tones that are layered are a Main Tone, selected using the Bank and Number buttons, and a Sub Tone assigned for each Main Tone. The assigned Tone for either of these could be a Capital or a Variation. For how to assign a Sub Tone, see "Lower Tone" (☞ page 25).**

* **The Sub Tone selected in Dual is played with the following settings.**

[Tone Level] The Tone Level setting for each Tone is ignored, and the volume is set according to "Sub Tone Level" (☞ page 26).

[FAT] FAT effect cannot be applied to a Sub Tone.

[Reverb: Mode/Time/Delay Feedback]

[Chorus: Delay/Rate/Depth/Feedback]

Same as settings for the Main Tone.

* **Reverb and Chorus on/off and level settings will be the same as the settings for that Tone.**

[Other settings that can be made for each tone]

Same as the settings for that Tone.

For a more detailed explanation, see the section "Changing the way the Sounds Play in Each Tone and Drum Set" (☞ page 30).

●Turning Split and Dual On and Off

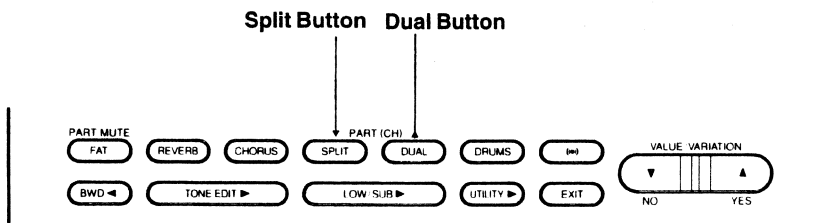

<<How to: Turn Split On and Off>>

Press the **SPLIT** button to turn Split on. When it's on, you will see "SPLIT" in the display. Press the **SPLIT** button again to turn off Split. The Split on/off setting is stored with each Tone.

- * The Split setting can be edited for each Tone. For how to do this, see the section called "Split Settings" (see page 25).
- * You can't have Split and Dual turned on at the same time.

<<How to: Turn Dual On and Off>>

Press the **DUAL** button to turn Dual on. When it's on, you will see "DUAL" in the display. Press the **DUAL** button again to turn off Dual. The Dual on/off setting is stored with each Tone.

- * The Dual setting can be edited for each Tone. For how to do this, see the section called "Dual Settings" (see page 26).
- * You can't have Split and Dual turned on at the same time.

●Various Settings for Split and Dual

There are a variety of things you can change about the way Split and Dual are applied.

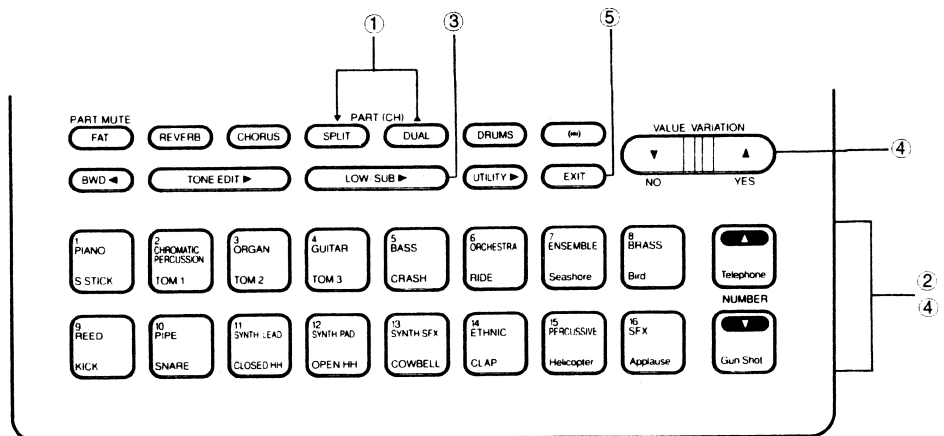

① Turn on the function you want (either Split or Dual).

- * If you are in Drum Play mode, first press the **DRUMS** button to switch to the standard Play mode.
- * If "MULTI" is lit in the display, that means you are in Multi mode. Set this to Single mode (see page 7).

- ② Select the Tone you wish to assign using the Bank and Number buttons.
- ③ Press the **LOW/SUB ▶** button until you have selected the function you wish to edit.
 - * If you accidentally scroll past it, back up with the **BWD ◀** button.
- ④ To assign a Lower Tone or Sub Tone, use the Bank and Number buttons to set that Tone. To set a Split Point or the output level, use VALUE **▲▼** to change the setting. While holding the **▲** button, you can increase the scrolling speed by pressing the **▼** button for the opposite direction. This procedure works for either button.
 - * To change more settings, repeat Steps ③ and ④.
- ⑤ Press **EXIT** to conclude the settings.
 - * The settings you have made now are stored, even if you turn off the power.

●Functions You Can Set

<<Split Settings>>

[Split Point]

[SplitPt E 4]

The Split Point can be set anywhere in a range from C-1 to F#9.

- * With Split turned on, you can easily check the Split Point by playing a connected MIDI keyboard.

[Lower Tone]

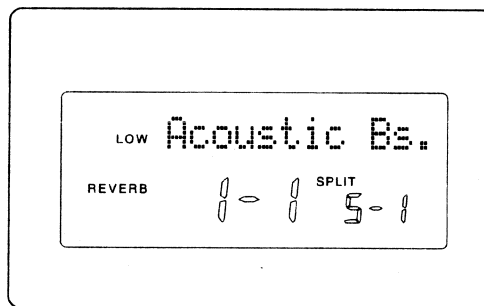

Assigns the Lower Tone when this is "Split".

- * The Lower Tone Bank and Number will be displayed in the lower left of the screen. You can check this if you have a MIDI keyboard connected to the Dr. Synth.
- * The Lower Tone can be a Capital or a Variation.

[Lower Tone Level]

[LOW Lev 100]

This adjusts the Lower Tone output level. You can also use it to change the balance between Upper and Lower Tones.

- * You have a MIDI keyboard connected, you can check the balance between the Upper and Lower Tones by playing the keyboard.

[Sub Tone]

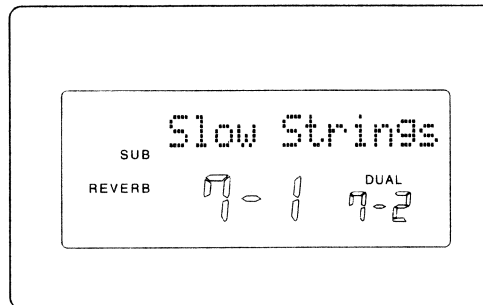

This is the Sub Tone setting for when Dual is on.

- * You will see the Bank and Number of the Sub Tone in the lower right of the display. You can check it by playing a few notes on your keyboard.
- * You can also set the Sub Tone to a Variation.

[Sub Tone Level]

[SUB Lev 100]

This adjusts the Sub Tone output level so that you can balance the volume between the Main and Sub Tones.

- * You can play your keyboard to test the balance with the Main Tone.

■ Playing the Drum Sets

The Dr. Synth has on-board “drum sets” that let you play a wide assortment of percussion instruments. There are eight different drum sets, so you’ll be able to find something appropriate for just about any situation.

● How to Play a Drum Set

Let’s try playing some of these percussion instruments using a MIDI keyboard.

<<Turning the Drum Mode On and Off>>

The Dr. Synth is usually setup to play regular Tones. When you wish to play a drum set, you must first switch to the Drum mode.

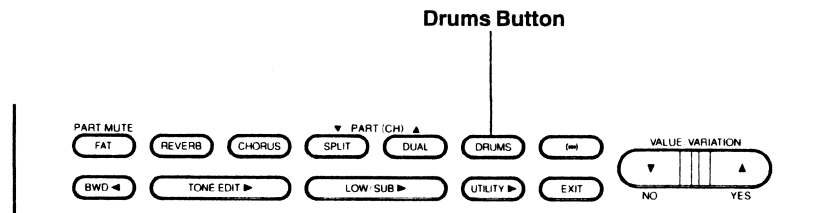

Pressing the **DRUMS** button enables you to play the drum sets. When you’re in Drum mode, the name of the currently selected drum set will be displayed. Press the **DRUMS** button again to return to the standard Tone Play mode.

* Each time you switch between Tone Play mode and Drum mode, the settings from the last time you were in that mode are called up again.

<<Playing the Drums Using the Dr. Synth>>

When you switch into Drum mode, the Dr. Synth Bank and Number buttons become Drum Part buttons.

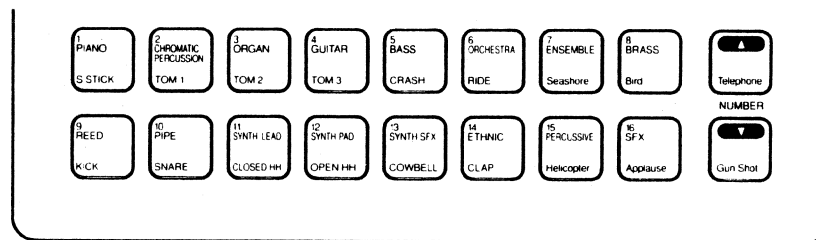

When you press one of these buttons, the percussion instrument corresponding to it will sound.

* Pressing the **((()))** button gives you a Stick sound, no matter which drum set is currently selected.

<<Playing the Drums Using a MIDI Keyboard>>

If you have a MIDI keyboard connected, you can use it to play the drums. Each key will play a different percussion instrument. (Some keys will have no sound assigned to them.)

⇒ See “Drum Set Table” (#37 page 90) for more about the percussion instruments in each drum set.

●Switching Between Drum Sets

You can select one of eight drum sets on the Dr. Synth.

PC# 1: STANDARD Set
PC# 9: ROOM Set
PC# 17: POWER Set
PC# 25: ELECTRONIC Set
PC# 26: TR-808 Set
PC# 33: JAZZ Set
PC# 41: BRUSH Set
PC# 49: ORCHESTRA Set

Select the appropriate drum set.

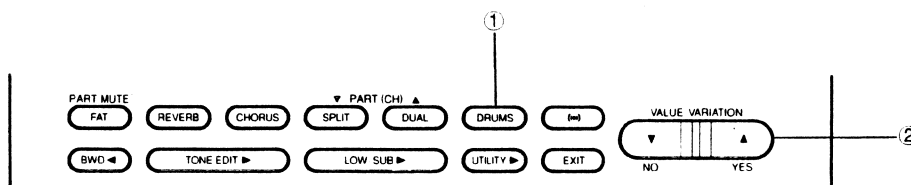

- ① Press **DRUMS** to select the Drum mode. You'll see the name of the current drum set in the display.
- ② Select the drum set you wish to use with the VALUE **▲**/**▼** buttons.
The drum set you select will be retained until you select a different one.
 - * **The percussion instruments that are available with drum pad in this mode will depend on the selected drum set. You can find out what instruments are in each set by checking the Drum Pad Table on page 91.**
 - * **If you wish to switch drum sets using a MIDI keyboard, see "Switching Drum Sets with an External MIDI Device" (page 67).**



**Single Mode/
Edit**

■ Changing the Way the Sounds Play in Each Tone and Drum Set

● Making Settings

All settings can be made by changing the values with the following procedure.

- * Each Tone is capable of storing the settings related to the way that Tone is played.
- * The settings are common to all eight drum sets. To change the settings that will be used when playing the drums, press the **DRUMS** button to switch into Drum mode.

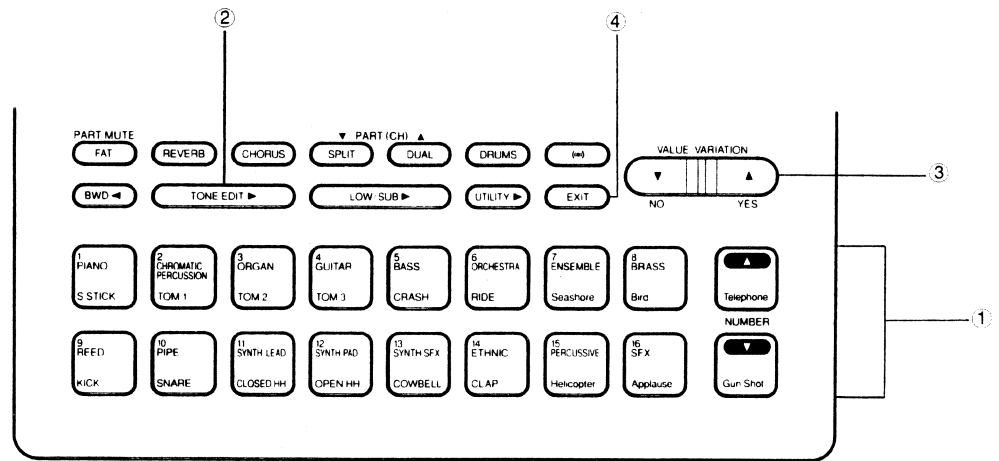

- ① Select a Tone with the Bank and Number buttons.
 - * If "MULTI" is lit in the display, that means you are in Multi mode. Set this to Single mode (⇄ page 7).
- ② Press the **TONE EDIT** button until you have selected the function you wish to edit.
 - * If you accidentally scroll past it, back up with the **BWD** button.
- ③ Edit the value with the **VALUE** buttons.

While holding the **▲** button, you can increase the scrolling speed by pressing the button for the opposite direction **▼**. This procedure works for either button.

 - * To change more settings, repeat Steps ② and ③.
- ④ Press **EXIT** to conclude the settings.
 - * The settings you have made are now retained, even if you turn off the power.

●Functions You Can Set

<The following functions are available in Single Mode Tone Play mode. A “Ⓧ” symbol is entered near the function names for each function that you can set in the Drum mode.>

<<Setting the Volume>>

[Tone Level] Ⓧ (0 to 127)

[TONE Lev 100]

This sets the output level for each Tone and drum set. This can be used to compensate for volume differences when switching Tones, or setting the balance with the drum set.

* **When Split or Dual is on, the volume of the Lower Tone or Sub Tone is set using “Lower Tone Level” (Ⓧ page 26) and “Sub Tone Level” (Ⓧ page 26).**

<<FAT Settings>>

You can set the kind of sound that will be layered on a Tone when FAT is turned on.

[FAT] Octave 1/Octave 2 Detune 1/Detune 2

[FAT Octave 1]

Octave 1: Adds the same Tone an octave lower to thicken the sound.

Octave 2: Adds the same Tone an octave lower and two octaves lower, creating an even “fatter” effect than Octave 1.

Detune 1: Adds a slightly pitch-shifted version of the original Tone. This produces a broad, chorus-like effect.

Detune 2: The level of the pitch-shifting is a little higher than in Detune 1, producing an even broader sound.

* **The FAT effect cannot be applied to Lower Tones or Sub Tones when Split or Dual are on.**

<<Reverb Settings>>

You can set the kind of effect you'll get when Reverb is turned on in the Tone and Drum modes.

* **With Split or Dual on, all Reverb settings (except for level) will be the same for the Lower and Upper Tones, or the Sub and Main Tones.**

[Reverb: Type]  Room 1/Room 2/Room 3
Hall 1/Hall 2/Plate
Delay/Pan Delay

[REV: Hall 2]

Set the type of Reverb.

Room 1/2/3 Simulate the sound of various rooms.

Hall 1/2 These settings duplicate the sound in various concert halls. These are deeper Reverbs than the Room settings.

Plate The plate Reverb setting duplicates the bright, metallic quality created by metal plate Reverb units.

Delay This setting broadens the sound and adds an echo effect.

Pan Delay This is a distinctive delay in which the delayed sound alternately moves from the right channel to the left. It is even more noticeable when the Delay Time is long.

* **The Pan Delay effect only works with a stereo output.**

[Reverb: Time]  (0 to 127)

[REV:Time 50]

Sets the following values for Reverb Time.

When Room, Hall or Plate is selected:

Sets the length of time for reverberations. The larger this value, the longer the reverberations continue.

When Delay or Pan Delay is selected:

Sets the time from when the original Tone is played to when you hear the first reverberation.

[Reverb: Delay Feedback]  (0 to 127)

[REV:DLyFB 50]

When Reverb Type is set to either Delay or Pan Delay, this sets the feedback volume. Larger values produce more repeats of the sound, and when set to 0, there will be only one repeat (or one in the right channel and one in the left for Pan Delay).

[Reverb: Level]  (0 to 127)

[REV:Lev 100]

This adjusts the volume of the Reverb or Delay sound. Large values correspond to higher volume, and at "127" the Reverb volume will be the same as that of the Tone or drum set.

* **When this is set to "0", you won't be able to turn the Reverb on.**

<<Chorus Settings>>

You can set the kind of effect you'll get when Chorus is on for the Tone and Drum modes.

* **With Split or Dual turned on, all Chorus settings (except for level) will be the same for the Lower and Upper Tones, or Sub and Main Tones.**

[Chorus: Delay] Ⓢ (0 to 127)

[CHO:Delay 0]

This adjusts the time until the Chorus effect is applied. Larger values correspond to longer times.

[Chorus: Rate] Ⓢ (0 to 127)

[CHO:Rate 3]

This sets the rate of oscillation in the Chorus effect. Larger values correspond to a faster oscillation.

[Chorus: Depth] Ⓢ (0 to 127)

[CHO:Depth 15]

This sets the depth of oscillation in the Chorus effect. Larger values correspond to a deeper oscillation.

[Chorus: Feedback] Ⓢ (0 to 127)

[CHO:FBack 0]

This sets the Chorus Feedback volume. The number of audible repeats increases as the values increase, and the Chorus sounds more and more like a flanger (a unique resonance similar to the sweeping sound of a jet engine). There is no feedback when this is set to "0", and you get the standard Chorus effect.

[Chorus: Level] Ⓢ (0 to 127)

[CHO:Lev 100]

This adjusts the volume of the Chorus sound. Large values correspond to higher volume, and at "127" the volume will be the same as that of the Tone or drum set.

* **When this is set to "0", you won't be able to turn the Chorus on.**

<<Control Settings>>

On the Dr. Synth, you can set the way each Tone is played by a connected MIDI keyboard.

[Bend Range] (0 to 24)

[BEND Rng 2]

This sets the amount by which the pitch can be changed using the pitch bend lever on a MIDI keyboard (i.e., in response to pitch bend messages).

This setting is in units of semi-tones, so the maximum setting corresponds to a pitch shift of two octaves.

[Modulation Depth] (0 to 127)

[MOD Def 10]

This sets the depth or intensity of modulation (vibrato effect, etc.) applied using the modulation lever (i.e., in response to modulation messages).

[Velocity Sens Depth] (0 to 127)

[VEL Def 64]

[Velocity Sens Offset] (0 to 127)

[VEL Offst 64]

You can set the relationship between playing strength (velocity) and the volume level actually produced.

When the Velocity Sens Depth parameter is set to a high value (above 64), the output volume will vary considerably even though the variation in your playing strength (velocity) is minimal. Conversely, when the Velocity Sens Depth is set to a low value (below 64), the output volume change very little, despite wide variation in playing strength (velocity).

The Velocity Sens Offset parameter also specifies how the output volume varies with playing strength (velocity), but in a slightly different manner.

At a value of 64 for both the Depth and Offset parameters (the default setting) there is a direct relationship between the play strength (velocity) and the output volume. For example, at minimum velocity, minimum volume is obtained and at maximum velocity, maximum output volume will be produced.

Values greater than 64 specify the minimum output level that can be produced by minimum velocity. Values less than 64 specify the minimum velocity at which the Instrument begins to sound.

* Sounds may not be output depending on the settings. If this occurs, set the Velocity Sens Depth or Velocity Sens Offset to higher values.

[Variation in Volume Resulting from Different Sens Depths and Constant Offset]

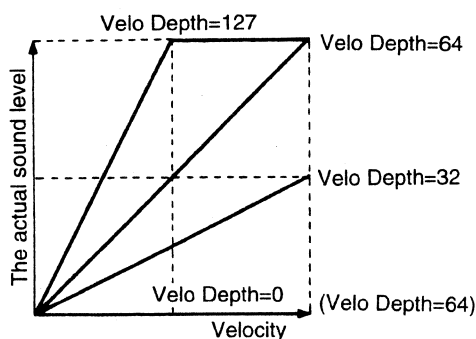

[Variation in Volume Resulting from Different Offsets and Constant Sens Depth]

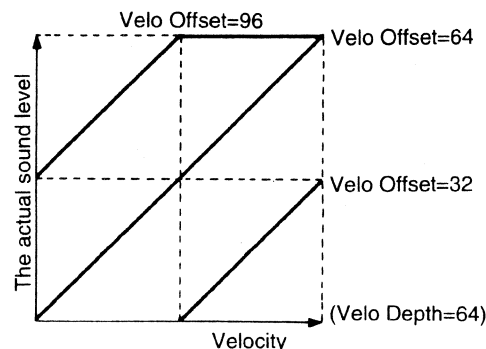

The actual volume that results from how hard you play a key will depend on the Velocity Sens Depth and Velocity Sens Offset as shown in the following diagrams.

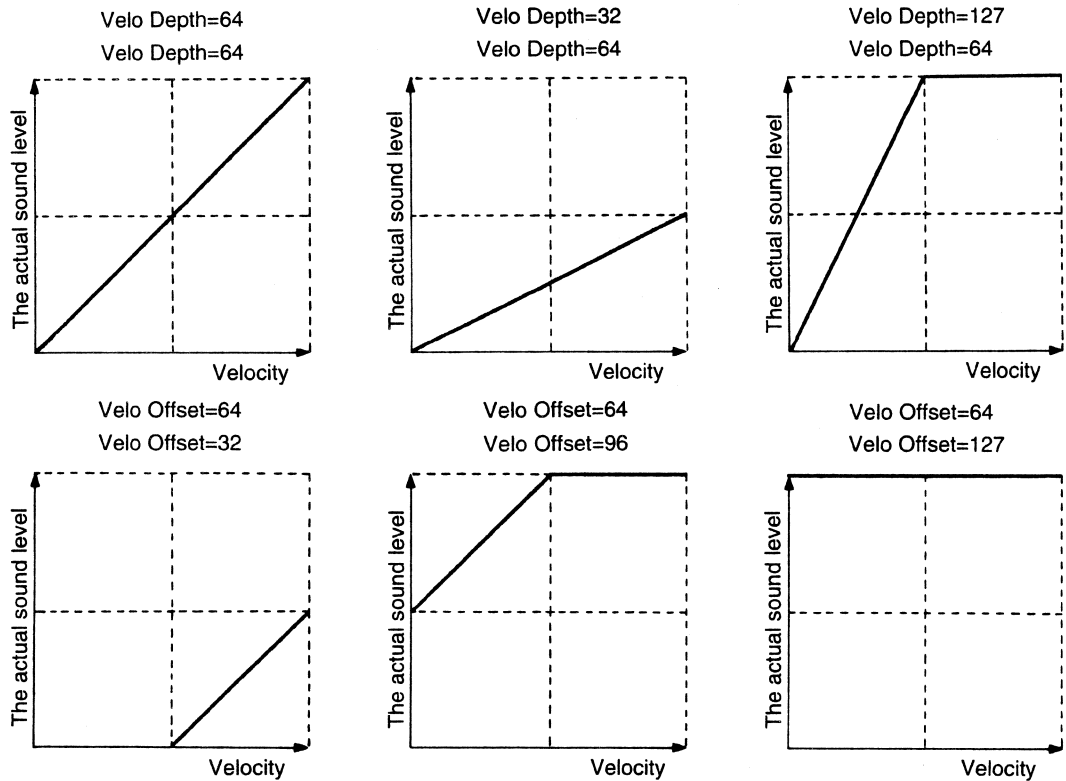

[M/P Mode] (Poly/Mono)

[POLY Mode]

Selects how the sounds will be played.

Poly: Multiple sounds are played simultaneously. This is the usual setting.

Mono: Plays only one sound at a time. Used primarily to play Tones (such as trumpet), where the instrument itself can only play one note at a time. Also effective on Tones such as "Synth Lead" when used for solo lines.

<<Vibrato Settings>>

Vibrato is a wavering of the pitch of a sound. As much (or as little) vibrato as you like can be applied to any of the Tones.

[Vibrato Rate] (-50 to +50)

[VIB Rate 0]

This adjusts the speed or rate of the pitch fluctuations.

Positive values indicate faster vibrato.

Negative values indicate slower vibrato.

[Vibrato Depth] (-50 to +50)

[VIB Def 0]

This adjusts the depth of the pitch fluctuations.

Positive values indicate deeper vibrato.

Negative values indicate shallower vibrato.

[Vibrato Delay] (-50 to +50)

[VIB Dly 0]

This adjusts the time before the vibrato begins to take effect.

Positive values indicate longer times

Negative values indicate shorter times

[Hold] (On/Off)

[HOLD 1 On]

This determines whether to respond to Hold messages (Controller #64) or not. When this is set to OFF, Hold messages from external MIDI devices will be ignored when received.

[Portamento] (On/Off)

[PORT On]

When Portamento is on and a key is played, the pitch will glide smoothly from that key to the pitch of the next key that is played.

[Portamento Time] (0 to 127)

[PORT.Time 64]

This sets the amount of time for the pitch to change when Portamento is on.

<<Changing Tone Characteristics>>

[Cutoff Frequency] (-50 to +50)

[CUTOFF F 0]

This adjusts the frequency at which cutoff of the upper harmonics begins. Whether this will make a difference in the sound depends on the Tone, but in general, the larger the number, the “warmer” or “rounder” the sound becomes.

⇒ Many of the Tones already have few upper harmonics. When this kind of Tone is selected, even a very high cutoff frequency won't make much difference to the sound.

[Resonance] (-50 to +50)

[RESONANCE 0]

This adjusts how much emphasis will be applied to the harmonic content in the vicinity of the cutoff frequency. In general, larger values of the resonance produce a more characteristic synthesizer-like sound.

<<Envelope>>

Adjusts the time variation of volume and cutoff frequency.

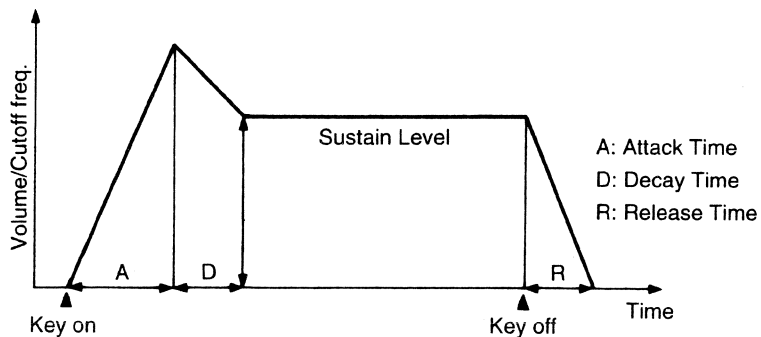

[Attack Time] (-50 to +50)

[ATTACK T 0]

Adjusts the rise time of the sound.

[Decay Time] (-50 to +50)

[DECAY T 0]

This adjusts the amount of time from the attack peak to when the sound reaches its sustain level (the level at which the sound sustains as volume and cutoff frequency variations die out.)

* For Tones that do not naturally have infinite sustain, such as piano and guitar, this adjusts the time for the sound to die out completely in the same way as the Release Time.

[Release Time] (-50 to +50)

[RELEASE T 0]

This adjusts the time it takes for the sound to die out completely.

■ Setting the Utility Features

You can make certain settings related to the system itself and how it handles MIDI information when the Dr. Synth is being used in Single Mode.

● How to Make Settings

You can change the settings with the following procedure.

- * Refer to the individual entries for “Map” and “Initialize” for an explanation of those functions.

Map: page 43

Initialize: page 44

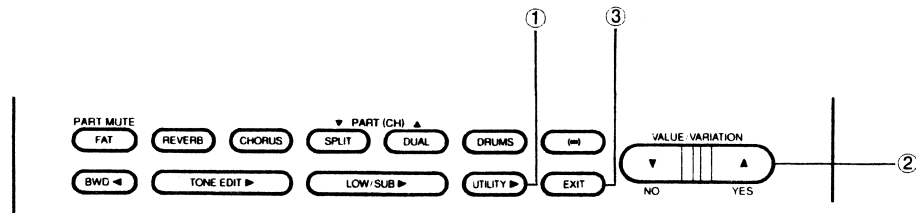

- ① Press **UTILITY** until you come to the function you want.

- * If you accidentally scroll past it, back up with the **BWD** button.
- * At some of the items, you may not be able to change the settings if you are not in the proper mode (Tone Play mode or Drum mode). In that case, you should switch modes before pressing the **UTILITY** button.
- * If “MULTI” is lit in the display, that means you are in Multi mode. Set this to Single mode (see page 7).

- ② Edit the value with the VALUE **▲**/**▼** buttons.

While holding the **▲** button, you can increase the scrolling speed by pressing the button for the opposite direction **▼**. This procedure works for either button.

- * To change more settings, repeat Steps ① and ②.

- ③ Press **EXIT** to conclude the settings.

- * The settings you have made are retained even if you turn off the power.

●Functions You Can Set

[Key Shift] (-24 to +24)

[KEY Shift 0]

Key Shift is a function that transposes the pitch in semi-tone increments. For each increase (or decrease) of "1" in the value, the overall pitch is raised (or lowered) by one semi-tone. A value of "12" corresponds to one full octave. If you do not wish to change the pitch, this should be set to "0".

* **Pitch Shift does not affect the pitch of drum sets.**

[Master Tune] (415.3 to 466.2 Hz, in 0.1 Hz increments)

[TUNE 440.0]

Master Tune is used to adjust the overall pitch of the Dr. Synth. Changing the Master Tune may be necessary when playing with other instruments.

* **The value in the display is the frequency of the A4 key on the keyboard. Usually this is set to 440.0 Hz.**

[MIDI Receive Channel] (1 to 16)

[MIDI CH 1]

This sets the channel over which MIDI messages (from a MIDI keyboard or other device) are received.

* **The receive channel must be the same as the transmit channel on the MIDI device connected to the Dr. Synth in order to receive MIDI messages. Be sure the MIDI channels on both devices match.**

[OMNI] (On/Off)

[OMNI On]

When Omni mode is on, Dr. Synth responds to all MIDI messages received, regardless of which channel they were received on.

[Program Change Receive Switch] (On/Off)

[PRG RX On]

This determines whether or not to respond to Program Change messages. When set to "OFF", Program Change messages from external MIDI devices will be ignored and the Tone will not be switched.

[MIDI Volume Receive Switch] (On/Off)

[VOL RX On]

This determines whether or not to respond to MIDI Volume messages (Controller #7). When set to "OFF", MIDI Volume messages from external MIDI devices will be ignored and the volume will not change.

[Device ID Number] (1 to 32)

[DEVICE No. 17]

The ID number is required in order to handle System Exclusive messages when transmitting or receiving data settings via MIDI, or when using several identical devices.

In the latter case, this is used to give each device a unique number. When the Dr. Synth is being used by itself, there is no need to change the ID number. (17 is the factory default setting.)

* **The Device ID setting made here is used for both Single mode and Multi mode.**

[Bulk Dump] (Tone: 1-1 through 16-8)

[DUMP TONE ?]

The settings for the indicated Tone are transmitted to an external MIDI device.

[Bulk Dump] (Drum Set) ①

[DUMP DRUM ?]

The settings for the drum set are transmitted to an external MIDI device.

* **Drum set settings are transmitted from the Drum mode.**

[Bulk Dump] (System)

[DUMP SYSTEM?]

The data for settings related to the system are transmitted to an external MIDI device.

[Bulk Dump] (All)

[DUMP ALL ?]

This function transmits all data to an external MIDI device.

* **See "Sending Data (Bulk Dump)" (page 68) for more about the procedure for making settings and transmitting Bulk Dump data.**

[Bulk Load]

[Bulk Load]

Receives data transmitted from an external MIDI device.

* See "Receiving Data (Bulk Load)" (page 72) for more about the procedure for making settings and receiving Bulk Dump data.

[Mode] (SINGLE/MULTI)

[SINGLE Mode]

This selects the Single or Multi mode.

[Single Mode] Use this mode when you want to use the Dr. Synth as an external sound module connected to a MIDI keyboard.

[Multi Mode] Select this mode when you want to use the Dr. Synth as a sound module connected to a sequencer in a desktop music system, or as a sound module for playing in Roland's GS Format.

* For more about the GS Format, see the section "The GM System and GS Format" (page 76).

[Contrast] (1 to 16)

[CONTRAST 10]

If the display is difficult to read (because of location or lighting conditions), use this function to adjust the display contrast.

[Map]

When Program Change messages are sent from a MIDI keyboard to switch Tones, you can arbitrarily set which Tone will actually be selected in response to a particular Program Change message.

[Procedure]

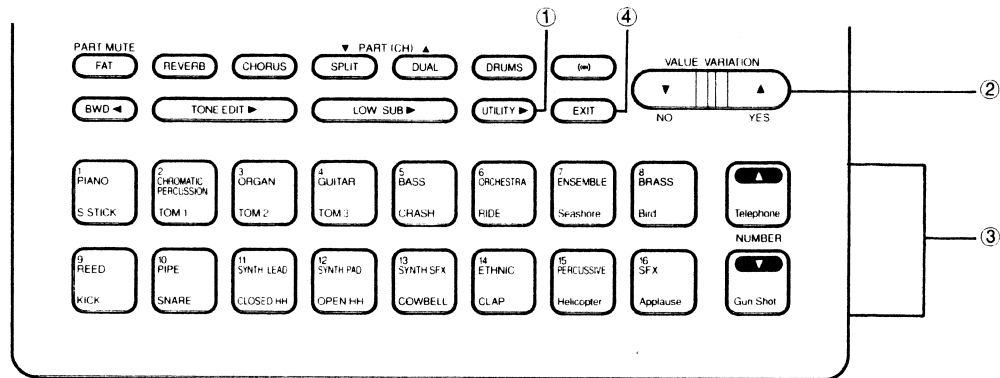

- ① Press the **UTILITY** button as many times as necessary to select the screen shown below.

[MAP] 1 → 1-1

- * If you accidentally scroll past it, back up with the **BWD** button.
- * If "MULTI" is lit in the display, that means you are in Multi mode. Set this to Single mode (see page 7).

- ② Set the received Program Change number with VALUE **▲**/**▼**.

While holding the **▲** button, you can increase the scrolling speed by pressing the button for the opposite direction **▼**. This procedure works for either button.

- * Alternately, you can set this by actually sending the desired Program Change number from a MIDI keyboard. The display will change to show the new setting.

- ③ Press the Bank and Number buttons for the Tone you want associated with that Program Change number.

- * To change more settings, repeat Steps ② and ③.

- ④ Press **EXIT** to conclude the settings.

Now whenever the Program Change number set in Step ② is received, you will switch to the Tone that was set in Step ③

- * The settings you have made are retained, even if you turn off the power.

[Initialize]

Returns all basic Tones and drum set settings to their original (factory set) values. The settings that are initialized are as follows:

- Initialize Tone: 1-1 through 16-8 can be initialized one at a time.
* **Tone initialization is carried out in Tone Play mode.**
- Initialize Drums: Reverb and Chorus settings can be initialized.
* **Drum initialization is carried out in Drum mode.**
- Initialize All: Initializes all Tone and Drum settings.

[Procedure]

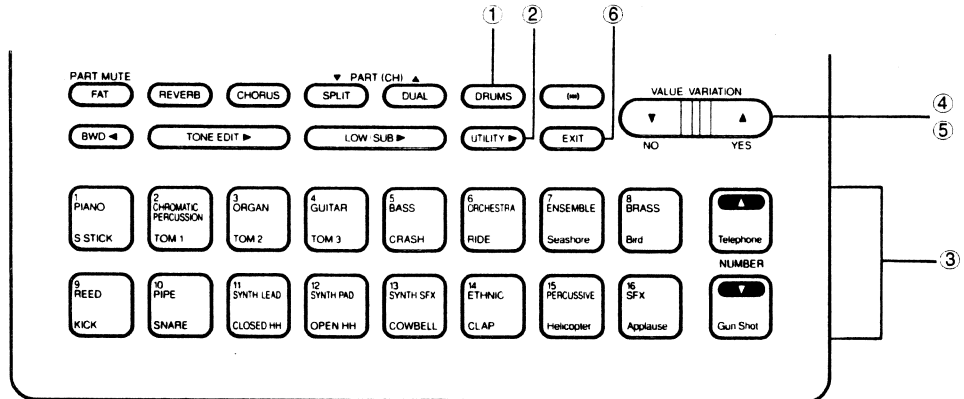

- ① Select the appropriate mode (Tone or Drum).
- ② Press the **UTILITY ►** button repeatedly until you reach the proper screen.

<<Initialize Tone>>

[Init TONE ?]

<<Initialize Drums>>

[Init DRUM ?]

<<Initialize All>>

[Init TONE/DR?]

- * If you accidentally scroll past it, back up with the **BWD ◀** button.
- * If "MULTI" is lit in the display, that means you are in Multi mode. Set this to Single mode (see page 7).

- ③ Specify the Tone to be initialized using the Bank and Number buttons.
 - * Skip this step for Initialize Drums or Initialize All when it isn't necessary.

- ④ Press **YES (VALUE [▲])**, and

[Sure? Yes/No]

this message will appear in the screen.

- ⑤ Press **YES (VALUE [▲])** again to confirm and the settings will be initialized. (If instead you decide to cancel, press **NO (VALUE [▼])**.)

- ⑥ Press **EXIT** to conclude the settings.

* To change more settings, repeat Steps ② through ⑤.

**Multi Mode/
Play**

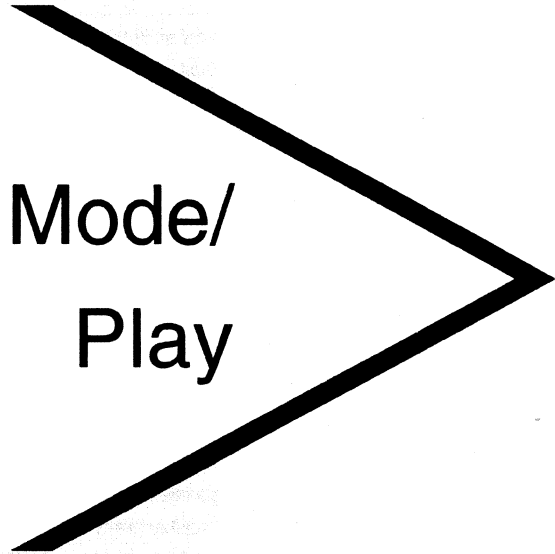

■ Selecting a Tone for Each Part

Let's try selecting a different Tone for each Part.

●Parts and Tones

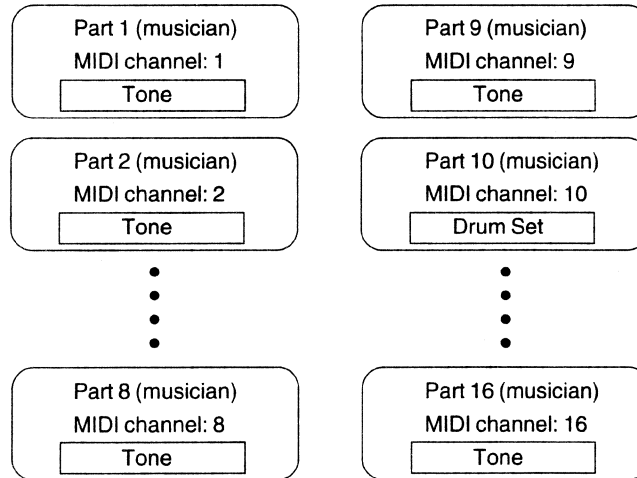

The following section briefly explains, the relationship between Part and Tone.

The Dr. Synth has 16 parts, and a different tone can be assigned to each. You can think of a Part as being a musician playing an instrument, and in this way, the Dr. Synth can be thought of as 16 musicians play many different instruments together.

A sound module such as the Dr. Synth is generally called a Multi-timbral sound module.

In an external MIDI device, MIDI channels 1 to 16 correspond to parts 1 to 16 of the Dr. Synth. When the Dr. Synth left the factory, it was preset so that part 1 corresponds to MIDI channel 1, part 2 corresponds to MIDI channel 2 and so on. When you want to hear the tone of a particular part, set the MIDI transmit channel of the external device (i.e. MIDI keyboard) to match the number of the part that you want to hear.

Most MIDI keyboards have only one or two MIDI transmit channels so there is a limit to the number of parts you can use at once. To make the best use of the Dr. Synth's functions, combine it with a device that was designed to transmit many channels of MIDI data, such as a sequencer.

⇒ For more details about MIDI refer to "About MIDI" (☞ page 64).

⇒ When you want to change the MIDI channel of a part, refer to "Part MIDI channel" (☞ page 55).

●Switching Tones for Each Part

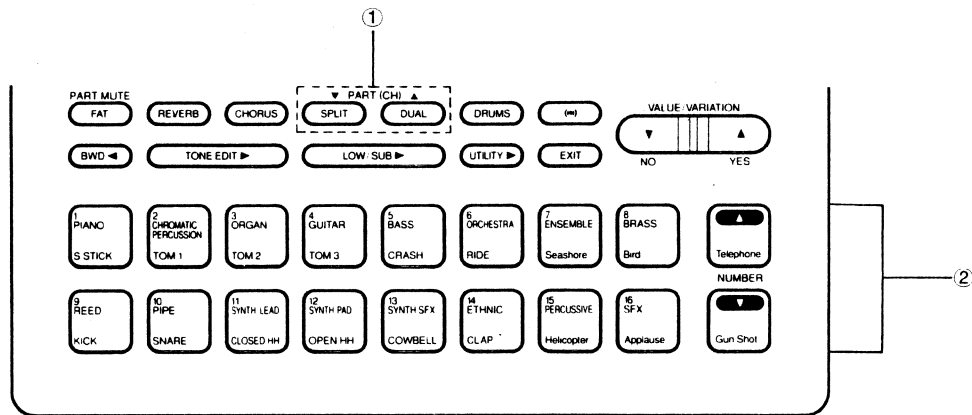

- ① Select the Part number (for which you wish to switch Tones) with the PART ▲▼ buttons. The Tone name assigned to the currently selected Part will appear in the display.
 - ② Select a new Tone with the Bank and Number buttons.
 - * For more information about this, see the section “Switching Tones” (☞ page 16).
 - * In Multi mode, you can register a Tone for each Bank button for up to 16 Parts. See the section “Registering Tones” (☞ page 17) for more information.
 - * If you are using a MIDI keyboard to switch Tones, refer to the section entitled “Switching Tones with an External MIDI Device” (☞ page 67).
- ⇒ Part 10 is assigned to the various percussion instruments that make up the drum sets. See the next page for more about drum sets.

■ Playing the Drum Sets

Let's play some of the percussion sounds.

● Drum Sets and Drum Parts

There are eight different drum sets containing a variety of percussion instruments.

When you use a drum set, you must assign one Part number to be the drum Part. The factory default setting assigns Part 10 (MIDI receive channel 10) as the drum part. When you use Part 10 with the drum set, be sure to set the MIDI transmit channel of the external MIDI device to "10". If you want to play the drum set but not change the MIDI transmit channel of the external MIDI device, assign the drum part to the MIDI receive channel/Part with the same number. See (see page 49) for more on how to do this.

⇒ If you are using a sequencer, you will have to match the Note Number assignments used for various percussion sounds on the sequencer with the Note Number assignments used for those same sounds on the drum set. The Note Numbers on the Dr. Synth are found in the "Drum Set Table" (see page 90).

● How to Play the Drum Sounds

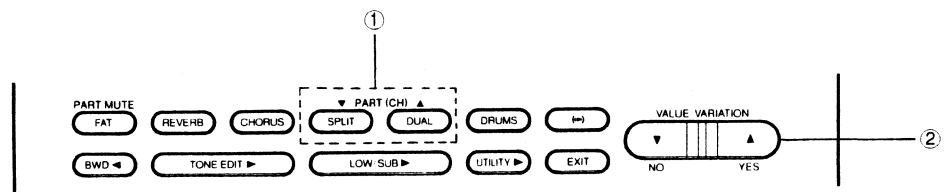

- ① Press PART to select Part 10.
The currently selected drum set will be displayed.
 - ② Press the VALUE buttons to select a different drum set.
This drum set selection will be retained until the next time you change drum sets.
 - ③ Now, if you have a MIDI keyboard connected, you should be able to play some of the keys to hear a variety of percussion sounds. (Not all the keys have sounds assigned to them.)
 - * **Be sure you have the MIDI transmit channel of the MIDI keyboard set to "10".**
 - * **If you want to change the drum set from the MIDI keyboard, refer to the section "Switching Drum Sets with an External MIDI Device" (see page 67).**
- ⇒ To find out what percussion instruments are assigned to a drum set, see "Drum Set Table" (see page 90).

●Assigning the Drum Set to a Different Part

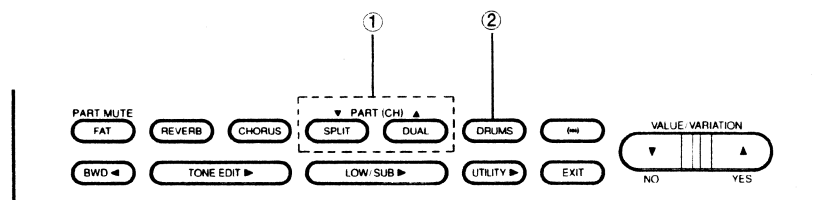

- ① Press PART to select the Part you wish to be the drum Part.
- ② Press the **DRUMS** button so that the display reads either “Dr1” or “Dr2”.
Each press of the **DRUMS** button cycles you through the following screens: a Tone name, “Dr1”, “Dr2”, then Tone name again, and so on.
 - * **When you return to a standard Part, the Tone name will be displayed.**
 - * **You can assign multiple Parts to the drum Part. There are two such drum sets that can be handled simultaneously, Dr 1 and Dr 2.**

For example, if you assign the drum Parts as follows, when you switch the Part 1 drum set to ROOM set, the Part 3 drum set is also switched to ROOM set.

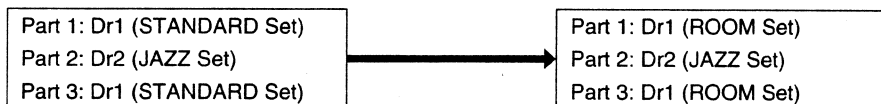

■ Adding Reverb and Chorus

Reverb and Chorus change the ambience of a Tone. You can apply as much or as little effect as you like.

● Reverb On/Off

Reverb adds a lingering decay sound to the Tone, as if you were hearing it in a spacious concert hall.

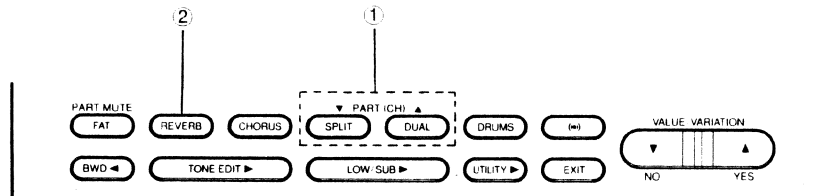

- ① Press PART to select the Part for which you wish to turn Reverb on or off.
- ② Press the **REVERB** button to turn Reverb on. When it's on, you will see "REVERB" in the display. Press the **REVERB** button again to turn off the effect.

The Reverb on/off setting is stored with each Part.

- * The Reverb Level can be set individually for each Part. For how to do this, see the section called "Functions you can set" (see page 55).
- * If the Reverb Level is set to "0", you won't be able to turn the Reverb on (see page **).

● Chorus On/Off

Chorus adds a "thickening" effect to sounds (especially effective on organ and strings).

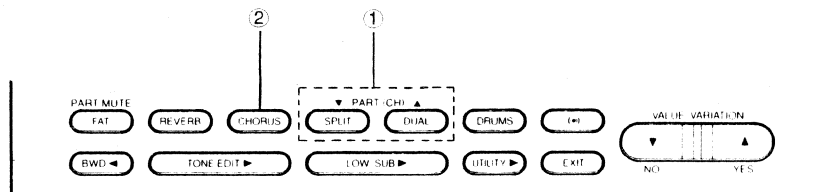

- ① Press PART to select the Part for which you wish to turn Chorus on or off.
- ② Press the **CHORUS** button to turn Chorus on. When it's on, you will see "CHORUS" in the display. Pressing the **CHORUS** button again turns off the Chorus.

The Chorus on/off setting is stored with each Part.

- * The Chorus Level can be set individually for each Part. For how to do this, see the section called "Functions you can set" (see page 55).
- * If the Chorus Level is set to "0", you won't be able to turn the Chorus on.

■ Part Mute

Part Mute is used when you want to keep a certain Part from sounding. Mute can be applied to individual Parts, or several Parts at once.

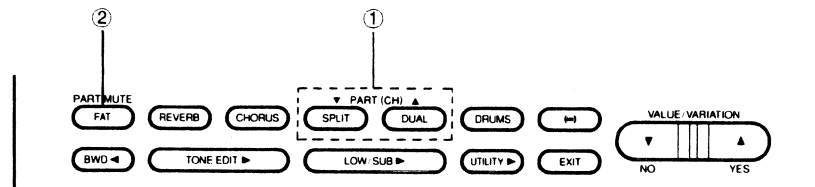

- ① Press PART to select the Part you wish to Mute.
- ② Press the **PART MUTE (FAT)** button to turn Part Mute on.
When it's on, the Tone Name in the display will change as shown below.
Pressing **PART MUTE (FAT)** again turns off Part Mute.

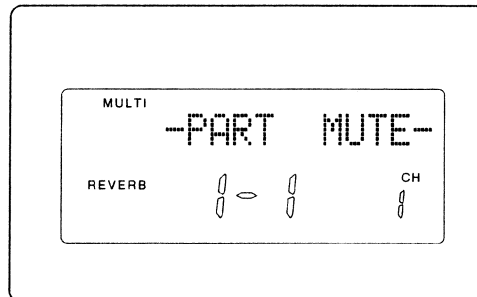

MEMO



**Multi Mode/
Edit**

■ Changing the Level and Effects Level of Each Part

This adjusts the volume and Reverb/Chorus Level for each Part.

●How to Make Settings

All settings can be changed using the following procedure.

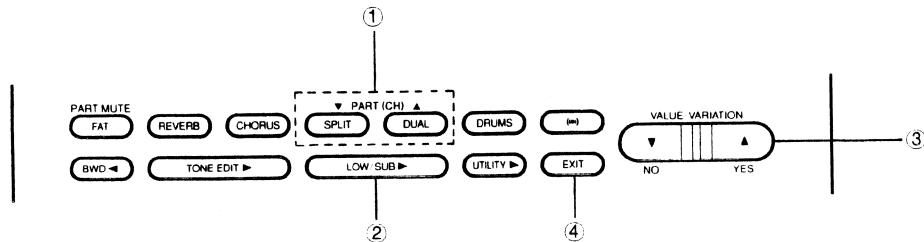

- ① Select the Part you wish to set using PART \uparrow / \downarrow .
 - * If "MULTI" is not lit in the display, that means you are in Single mode. Set this to Multi mode (see page 7).
- ② Press the **LOW/SUB** \blacktriangleright button until you have selected the function you wish to edit.
 - * If you accidentally scroll past it, back up with the **BWD** \blacktriangleleft button.
- ③ Change this value using the VALUE \uparrow / \downarrow buttons.
 - While holding the \uparrow button, you can increase the scrolling speed by pressing the \downarrow button for the opposite direction. This procedure works for either button.
 - * To change more functions, repeat Steps ① through ③.
- ④ Press **EXIT** to conclude the settings.
 - * If you wish to change the same function for different Parts, all you have to do is repeat Steps ① and ③. The function you selected before will remain selected.
 - * The settings you have made are retained, even if you turn off the power.

●Functions you can set

[Part Level] (0 to 127)

[Part:Lev 127]

Adjusts the volume of each Part. You can use this to adjust the balance between Parts.

[Part Pan] (Rnd, L63 to 0 to R63)

[Part:Pan 0]

The pan setting of each part determines the stereo location of each instrument.

"0" indicates a central stereo location. Higher "L" values indicate that more sound will be heard from the left speaker. Higher "R" values indicate that more sound will be heard from the right speaker. When "Rnd (random)" is selected, the sound will be moved to a different stereo location every time the tone is heard. This random panning creates a unique effect.

⇒ The Drum Set has a preset stereo location for each percussion sound. If you change the pan level of the drum part, the stereo location of the entire Drum Set will be moved.

-
- * According to the tone, even if you position pan to all the way left (or right) a small amount of sound might leak from the other speaker.
 - * When the Dr.Synth is connected to a monaural audio system, some effects cannot be properly attained.

[Reverb: Level] (0 to 127)

[REV:Lev 127]

Adjusts the volume of the Reverb sound and Delay sound for each Part. The volume increases as this value increases. You can use this function to adjust the balance between Parts.

- * When this is set to "0", you won't be able to turn the Reverb on.

[Chorus: Level] (0 to 127)

[CHO:Lev 127]

Adjusts the volume of the Chorus sound for each Part. The volume increases as this value increases. Use this function to adjust the balance between Parts.

- * When this is set to "0", you won't be able to turn the Chorus on.

[Part Key Shift] (-24 to +24)

[P:K.Shift 0]

Set the key shift of a part when you want to transpose only a specified tone.

For each increase (or decrease) of "1" in the value, the overall pitch is raised (or lowered) by one semi-tone. A value of "12" corresponds to one full octave. If you do not wish to change the pitch, this should be set to "0".

- * Pitch Shift does not affect the pitch of drum sets.

[Part MIDI Channel] (1 to 16, Off)

[Part:Ch 1]

This sets the MIDI channel for each Part.

- * If you change the MIDI channel number so that it's no longer the same as the Part number, the "CH" indication will disappear from the display.

■ Master Level and Effect Settings

Here we will set the overall volume and the volume of the effects. These settings affect all Parts, i.e., are “common” to all Parts.

●How to Make Settings

All settings can be changed using the following procedure.

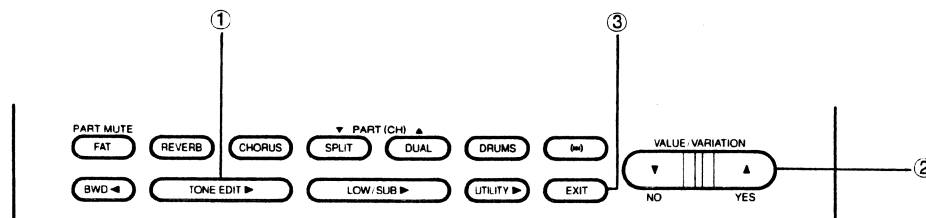

- ① Press the **TONE EDIT** button until you have selected the function you wish to edit.
 - * If you accidentally scroll past it, back up with the **BWD** button.
 - * If “MULTI” is not lit in the display, that means you are in Single mode. Set this to Multi mode (see page 7).
- ② Change this value using the VALUE **▲**/**▼** buttons.
 - While holding the **▲** button, you can increase the scrolling speed by pressing the **▼** button for the opposite direction. This procedure works for either button.
 - * To change more functions, repeat Steps ① and ②.
- ③ Press **EXIT** to conclude the settings.
 - * The settings you have made are retained, even if you turn off the power.

●Functions You Can Set

<<Overall Volume Settings>>

[Master Level] (0 to 127)

[M:Lev 100]

This sets the overall output volume for all 16 Parts.

- ⇒ This adjusts the overall volume level within the limits set by the VOLUME knob. That is, increasing this value will have no effect if the VOLUME knob is set to minimum.

<<Reverb Settings (Multi Mode)>>

In Multi mode, you can set the Reverb effect that will be applied to all Parts (when Reverb is on).

[Reverb: Type] Room 1/Room 2/Room 3
Hall 1/Hall 2/Plate
Delay/Pan Delay

[M:REV Hall 2]

Set the type of Reverb.

Room 1/2/3	Simulate the sound of various rooms.
Hall 1/2	These settings duplicate the sound in various concert halls. These are deeper Reverbs than the Room settings.
Plate	The plate Reverb setting duplicates the bright, metallic quality created by metal plate Reverb units.
Delay	This setting broadens the sound and adds an echo effect.
Pan Delay	This is a distinctive delay in which the delayed sound alternately moves from the right channel to the left. It is even more noticeable when the Delay Time is long.

* **The Pan Delay effect only works with a stereo output.**

[Reverb: Time] (0 to 127)

[M:REUTime 50]

Sets the following values for Reverb Time.

When Room, Hall or Plate is selected:

Sets the length of time for reverberations. The larger this value, the longer the reverberations continue.

When Delay or Pan Delay is selected:

Sets the time from when the original Tone is played to when you hear the first reverberation.

[Reverb: Delay Feedback] (0 to 127)

[M:RVDlyFB 0]

When Reverb Type is set to either Delay or Pan Delay, this sets the feedback volume. Larger values produce more repeats of the sound, and when set to "0", there will be only one repeat (or one in the right channel and one in the left for Pan Delay).

[Reverb: Level] (0 to 127)

[M:REV Lev 50]

This adjusts the volume of the Reverb or Delay sound. Large values correspond to higher volume.

* **When this is set to "0", you won't hear any effect even if Reverb is on.**

<<Chorus Settings (Multi Mode)>>

In Multi mode, you can set the Chorus effect that will be applied to all Parts (when Chorus is turned on).

[Chorus: Delay] (0 to 127)

[M:CHO Dly 0]

This adjusts the time before the Chorus effect is applied. Larger values correspond to longer times.

[Chorus: Rate] (0 to 127)

[M:CHORate 3]

This sets the rate of oscillation in the Chorus effect. Larger values correspond to a faster oscillation.

[Chorus: Depth] (0 to 127)

[M:CHO Def 14]

This sets the depth of oscillation in the Chorus effect. Larger values correspond to a deeper oscillation.

[Chorus: Feedback] (0 to 127)

[M:CHO FB 0]

This sets the Chorus Feedback volume. The number of audible repeats increases as the values increase, and the Chorus sounds more and more like a flanger (a unique resonance similar to the sweeping sound of a jet engine). There is no feedback when this is set to "0", and you get the standard Chorus effect.

[Chorus: Level] (0 to 127)

[M:CHO Lev 50]

This adjusts the volume of the Chorus sound. Large values correspond to higher volume.

* If this is set to "0", you won't hear any effect even if Chorus is on.

■ Setting the Utility Features

You can make certain settings related to the system itself and how it handles MIDI information when the DS-330 is being used in Multi Mode.

●How to Make Settings

You can change the values with the following procedure.

* Refer to the “GS Initialize” section for an explanation of that function.

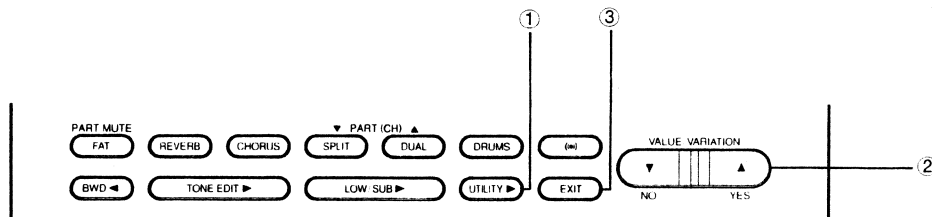

- ① Press **UTILITY** as many times as it takes to select the function you want.
 - * If you accidentally scroll past it, back up with the **BWD** button.
 - * If “MULTI” is not lit in the display, that means you are in Single mode. Set this to Multi mode (see page 7).
- ② Edit the value with the VALUE **▲** **▼** buttons.

While holding the **▲** button, you can increase the scrolling speed by pressing the **▼** button for the opposite direction. This procedure works for either button.

 - * To change more settings, repeat Steps ① and ②.
- ③ Press **EXIT** to conclude the settings.
 - * The settings you have made are retained, even if you turn off the power.

●Functions You Can Set

[Key Shift] (-24 to +24)

[KEY Shift 0]

Key Shift is a function that transposes the pitch in semi-tone increments. For each increase (or decrease) of “1” in the value, the overall pitch rises (falls) by one semi-tone. A value of “12” corresponds to a full octave. If you do not wish to change the pitch, this should be set to “0”.

[Master Tune] (415.3 to 466.2 Hz, in 0.1 Hz increments)

[TUNE 440.2]

Master Tune is used to adjust the overall pitch of the Dr. Synth. This is useful when you are playing with other instruments.

* The value in the display is the frequency of the A4 key on the keyboard.

[Mute Lock] (On/Off)

[MUTElock Off]

When you have Mute turned on for certain Parts during playback of song data, these Part Mute settings may be canceled if you play that song data again from the beginning. This is because there is something called GS Reset data at the beginning of the song data that initializes all the primary settings of a GS sound module, including Part Mute. You can set it so that Mute is not canceled by the GS Reset, and that way you will not have to reset the Mute every time you play song data from the beginning.

It's also convenient, when you are muting everything except certain Parts, to repeat the song a number of times to check those particular Parts.

* For an explanation of Part Mute, see "Part Mute" (page 51).

[GS Reset Receive Switch] (On/Off)

[GSresetRX On]

This determines whether or not to respond to GS Reset messages.

Dr. Synth will return to the basic GS setting when a GS Reset or General MIDI System On message is received. Set this switch to off if you do not want the setting data initialized when these messages are received.

* The factory default setting for this is ON.

[Program Change Receive Switch] (On/Off)

[PRG RX On]

This determines whether or not to respond to Program Change messages. When set to "Off", Program Change messages from external MIDI devices will be ignored and the Tone will not be switched.

* This is automatically set to On when a GS Reset is received from an external device so that Program Change messages are received.

[Device ID Number] (1 to 32)

[DEVICE No. 17]

The ID number is required to handle System Exclusive messages when transmitting or receiving data via MIDI, or when using several identical devices.

In the latter case, this is used to give each device a unique number. When the Dr. Synth is being used by itself, there is no need to change the number. (17 is the factory default setting.)

* **The Device ID setting made here is used for both Single and Multi mode.**

[Bulk Dump] (Part)

[DUMP PART ?]

Transmits the settings for each Part. You can also set which Parts are not to be transmitted.

[Bulk Dump] (System+Part)

[DUMP SYS+PT?]

Transmits the data for settings related to the system and Parts. You can also set which Part data is not to be transmitted.

[Bulk Dump] (All)

[DUMP ALL ?]

This transmits all data to an external MIDI device.

* See "Sending Data (Bulk Dump)" (see page 68) for more about the procedure for making settings and transmitting Bulk Dump data.

[Mode] (SINGLE/MULTI)

[MULTI Mode]

This determines whether the DS-330 will be using Single mode or Multi mode.

[Single Mode] Use this mode when you want to use the Dr. Synth as an external sound module connected to a MIDI keyboard.

[Multi Mode] Select this mode when you want to use the Dr. Synth as a sound module connected to a sequencer in a desktop music system, or as a sound module for playing in the GS Format.

* **For more about GS Format, see the section "The GM System and GS Format" (see page 76).**

[Contrast] (1 to 16)

[CONTRAST 10]

The display screen can sometimes be difficult to read, depending on location or lighting conditions. This control adjusts the display contrast.

[GS Initialize]

This initializes (resets) any settings you have changed in Multi mode back to the original values.

[Procedure]

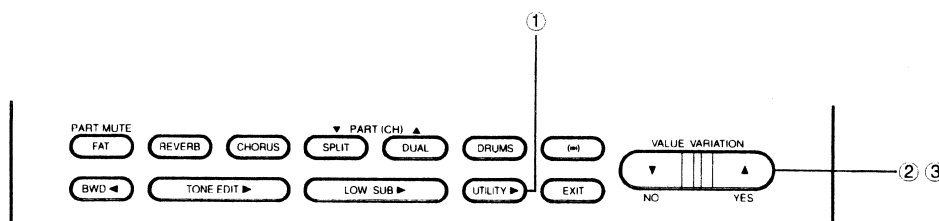

- ① Press the **UTILITY ►** button until you see a screen like the following.

[Init GS ?]

- * If you accidentally scroll past it, back up with the **BWD ◀** button.
- * If "MULTI" is not lit in the display, that means you are in Single mode. Set this to Multi mode (see page 7).

- ② Press **YES (VALUE [▲])**, and...

[Sure? Yes/No]

...this message will appear in the screen.

- ③ Press **YES (VALUE [▲])** again to confirm and the settings will be initialized. (If instead you decide to cancel, press **NO (VALUE [▼])**.)



MIDI Applications

The DS-330 is equipped with MIDI connectors. It is controlled by MIDI messages received through these connectors when used as a sound module for a MIDI keyboard or sequencer. In this section we will explain a few basic things related to MIDI and some ways to use it.

* **If this is your first experience with a MIDI device, be sure to read the following introduction to MIDI.**

□ About MIDI

MIDI stands for Musical Instrument Digital Interface, a world-wide standard for the exchange of digital music data between electronic musical instruments and computers. A MIDI-compatible instrument can read and understand patch switching messages or performance data sent from another MIDI instrument, even if they are completely different models or made by different manufacturers.

In the MIDI standard, "performance data" means data describing which keys are played, for how long, at what volume, etc., or when a pedal is pressed. All of this information is handled as MIDI "messages".

1. Exchanging MIDI Messages

First, we'll explain in simple terms how MIDI messages are exchanged.

● About MIDI Connectors

MIDI messages are transmitted and received via three MIDI connectors.

MIDI IN: Messages from external MIDI devices are received here.

MIDI OUT: MIDI messages from the Dr. Synth are sent to external MIDI devices from here.

MIDI THRU: Transmits an exact copy of all messages received via MIDI IN.

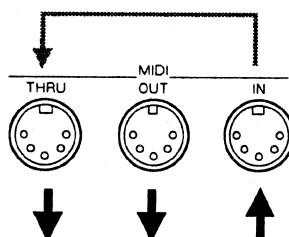

* **With a MIDI THRU connector you could theoretically hook up any number of MIDI devices so that they could all receive the same signal ("daisy chain"), although in reality you are limited to four or five at most. Adding more devices to a chain may result in signal delay and deterioration.**

●MIDI Channel

Channel messages also allow you to transmit different MIDI messages to different MIDI devices when you have them all connected at the same time. This is where the idea of MIDI channels is important.

You might think of MIDI channels as similar to television channels. When you switch television channels, you can see programs from a variety of different television stations. You must, however, be tuned to the TV station in order to receive the information (i.e., see the program).

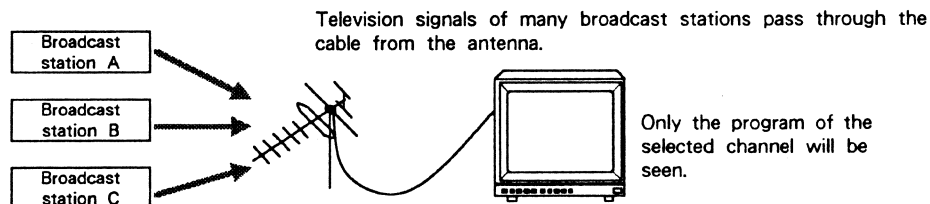

MIDI has channels too, numbered from 1 to 16, and only when the transmitting channel is the same as the receiving channel is the MIDI data transmitted. For instance, in the setup below, only Sound Module B will sound when you play the keyboard, because it is receiving on the same channel that the keyboard is transmitting (channel 1).

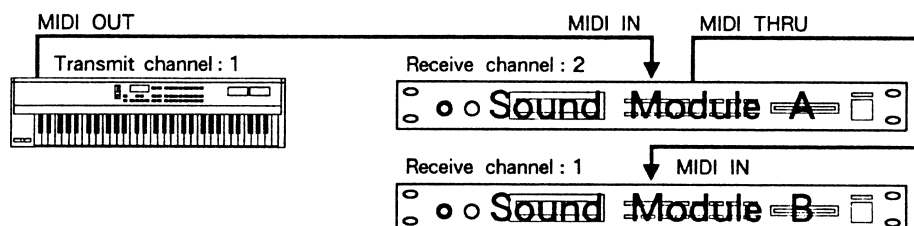

There is, however, one major difference: a TV lets you see only one program at a time, whereas on the Dr. Synth you can receive and play data on up to 16 MIDI channels at once! This way you can take 16 Parts, one per channel, and play them all at once, with a different instrument for each channel. In general, any sound module that can do this is called "multi-timbral". The Dr. Synth is a multi-timbral sound module when it's in Multi mode.

●Omni Mode

When OmniMode is on, the Dr. Synth will respond to all MIDI messages — no matter which channel they were received on.

2. MIDI Messages Handled by the Dr. Synth

There are a variety of MIDI messages and each has information about a particular kind of performance nuance. MIDI messages are broadly divided into Channel Messages (those that have information specific to a channel), and System Messages (information that applies to the system as a whole).

●Channel Messages

The MIDI messages that transmit the actual performance data are Channel messages, and these are the ones that do most of the actual work of controlling the MIDI instrument. As there are many different kinds of MIDI instruments, what exactly is controlled by MIDI messages depends on the design of a particular instrument.

Note Messages

These contain information about keyboard performances, including the following:

Note number	A number indicating the note (key) that was pressed or released.
Note on	A message indicating that a note (key) was pressed.
Note off	A message indicating that a note (key) was released.
Velocity	A number indicating how strongly the note (key) was pressed.

Each note on the keyboard is represented by a number between 0 and 127, with middle C (C4) being Note Number 60. On a drum set, each Note Number defines a different percussion instrument, so that you can play just that one sound by sending the appropriate Number.

Pitch Bend Messages

These transmit data about how the pitch bend lever on a synthesizer has been used.

Program Change Messages

These transmit Tone switching commands. In general you can switch among 128 different Tones (Program Numbers 1 to 128). On the Dr. Synth, you can also switch to Tone Variations using Control Change messages.

Control Change Messages

These transmit data about performance-enhancing features like vibrato, hold and volume. Each feature is assigned an identifying Controller number between 0 and 127. Not all MIDI instruments have the same features, so response to Control Change numbers will vary.

On the Dr. Synth, the value of Controller #0 is used with Program Change messages to switch to a Tone Variation.

●System Messages

System Messages include SysEx (system exclusive) and messages needed for timing and synchronization. These messages affect the system as a whole and are not broken up into specific channels. The Dr. Synth can only handle SysEx messages.

System Exclusive Messages

SysEx messages are used for controlling special features of a particular MIDI device. In general, you can swap SysEx data with any other MIDI device made by the same manufacturer. They are also used to transmit Dr. Synth system and Part settings to an external sequencer.

●MIDI Implementation Chart

MIDI allows many different musical instruments and devices to exchange data. It is not necessarily the case, however, that all MIDI messages can be received by all MIDI devices. For example, you may set up your keyboard to send Aftertouch messages, but if the sound module you have connected doesn't respond to Aftertouch, you will not hear the effect you're looking for. The only way two devices can exchange a given MIDI message is if that function is available on both instruments. Each instrument has, in its owner's manual, a MIDI Implementation chart that will help you determine at a glance which features the instruments have in common. The dimensions of these charts are standardized, so you can fold them as shown and physically match them to see if the MIDI messages of one device will be received by the other.

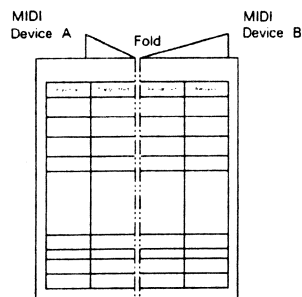

■ Switching Tones and Drums Sets With an External MIDI Device

You can switch Tones or drum sets on the Dr. Synth from an external MIDI device, such as a keyboard or sequencer.

● Switching Tones with an External MIDI Device

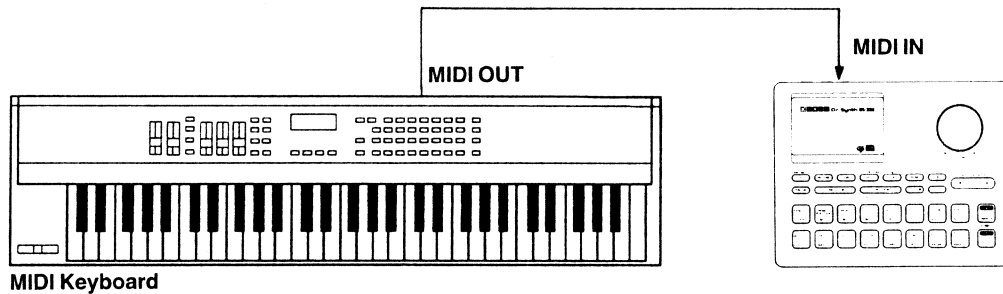

When you switch patches or Tones on the MIDI keyboard, the corresponding Program Change message is sent from its MIDI OUT connector. The Dr. Synth then receives that message and switches the Tone; the actual Tone you select is determined by the Program Change number transmitted in the message. So for example if you change to Patch 1 (whatever sound that might be) on the MIDI keyboard, that sends out a Program Change number 1 to the Dr. Synth, which responds by switching to the corresponding Tone number, in this case Piano 1. You'll want to check and see what Tones correspond to what patch numbers on your MIDI keyboard.

- ⇒ If you are switching Tones in Single mode, be sure the MIDI channels on both devices are set correctly. In Multi mode, be sure that the MIDI transmit channel of the external device is set to the Part number in which you want to be switching Tones on the Dr. Synth.
- ⇒ You can freely assign what Tone will play when a given Program Change number is received in Single mode using the Map function (☞ page 43).
- ⇒ See "Correspondence with Program Change Numbers" regarding the relation between Tone numbers of Dr.Synth and MIDI Program numbers.
- ⇒ Check the owner's manual of your MIDI keyboard to find out which Tone corresponds to which Program Change number.
- ⇒ There is a Program Change Receive switch you can turn off if you don't want the Dr. Synth to respond to Program Change messages (☞ page 40).

● Switching Drum Sets with an External MIDI Device

The Dr. Synth will switch drum sets in response to messages from an external MIDI device in Drum mode (just the same as in Tone Play mode).

- ⇒ On the Dr. Synth, the drum set numbers are the same as their corresponding Program Change numbers. See "Drum Set Table" (☞ page 90).
- ⇒ Check the owner's manual of your MIDI keyboard to find out which Tone corresponds to which Program Change number.
- ⇒ There is a Program Change Receive switch you can turn off if you don't want the Dr. Synth to respond to Program Change messages (☞ page 40).

● Switching Variations with an External MIDI Device

The Dr. Synth uses a combination of a Program Change message and Control Change message (Controllers #0 and #32) when switching Variations. These messages must be transmitted by the external device in this order:

- ① Controller #0 Value (the Variation number)
- ② Controller #32 (0)
- ③ Program Change Number (the Tone number)

* **You can only switch Variations from external MIDI devices when the DS-330 is in Multi mode.**

■ Transmitting Data via MIDI

Using SysEx messages, you can transmit identical settings from one Dr. Synth to another, or store them all in a BOSS BL-1 Bulk Librarian (sold separately) or sequencer. The sending of SysEx data from the Dr. Synth is called a Bulk Dump, and receiving it is called a Bulk Load.

◆ Sending Data (Bulk Dump)

Since the Dr. Synth stores data differently in Single mode and Multi mode, the procedure for sending that data is also different. You can also select the data to be sent in each mode.

<Selecting What to Send>

[Single Mode]

[Tone]

[DUMP TONE ?]

Sends all Tone settings for the Tone specified by the Bank and Number buttons (the one shown in the display).

[Drum Set]

[DUMP DRUM ?]

This sends drum set settings.

* **This must be done from Drum mode.**

[System]

[DUMP SYSTEM?]

This sends the following system settings for Single mode:

- Key Shift
- Tune
- Program Change Receive Switch
- Volume Change Receive Switch
- Map
- Tone-to-Bank button registrations.

[All]

[DUMP ALL ?]

This sends all the settings for Single mode.

[Multi Mode]

[Part]

[DUMP PART ?]

This sends all the Part settings assigned to each Part. If you don't want to send a certain Part, use Part Mute (* page 51) to prevent the settings from being sent.

[System+Part]

[DUMP SYS+PT?]

This sends all the Part settings assigned to each Part and all systems settings made in Multi mode. If you don't want a certain Part sent, use Part Mute (* page 51).

[All]

[DUMP ALL ?]

This sends all settings in Multi mode.

<Making the Connections>

●Saving to a BL-1 Bulk Librarian or Sequencer

To receive SysEx (Bulk Dump) data on a BL-1 or sequencer, connect things as shown below.

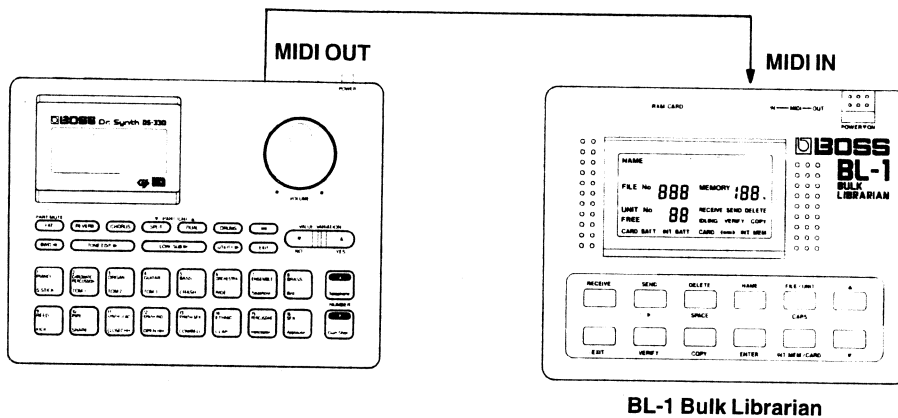

* To find out what you need to do on the BL-1 or sequencer, refer to their respective owner's manuals.

●Copying Data to Another Dr. Synth

To transfer SysEx data, connect things as shown. Then refer to "Receiving Data" (p. 72).

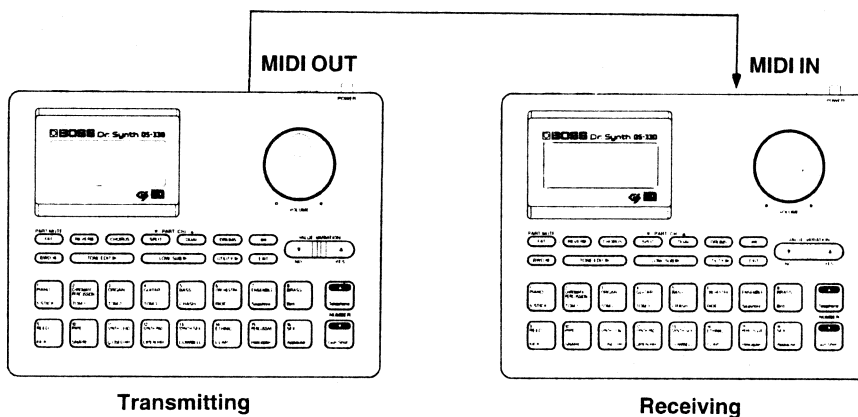

<Sending>

Before sending data, be sure the device ID numbers are the same on both devices. You won't be able to send data unless they match.

- 1 Select the appropriate mode for the data you want to send (Single or Multi).
- 2 Press the **UTILITY** button until you see a display like the following.
 - * If you accidentally scroll past it, back up with the **BWD** button.
 - * This is where you can select the Tone (Single mode) or Part (Multi mode) that you wish to send.

[Single Mode]

[DUMP TONE ?]

[DUMP DRUM ?]

[DUMP SYSTEM?]

[DUMP ALL ?]

[Multi Mode]

[DUMP PART ?]

[DUMP SYS+PT?]

[DUMP ALL ?]

- ③ Press , and...

[Sure? Yes/No]

...this message will appear in the screen.

- ④ Press again to confirm and the data transfer will begin. (If instead you decide to cancel, press .)

When the transfer is complete, you will be returned to the state in Step ②. Repeat Steps ② through ④ to copy more data.

- ⑤ Press to end the procedure.

◆ Receiving Data (Bulk Load)

This receives data stored in external MIDI devices.

<Making the Connections>

● Transmitting Data Stored in a BL-1 Bulk Librarian or Sequencer to the Dr. Synth

Connect things as shown below.

The following procedure puts you in the receive standby mode.

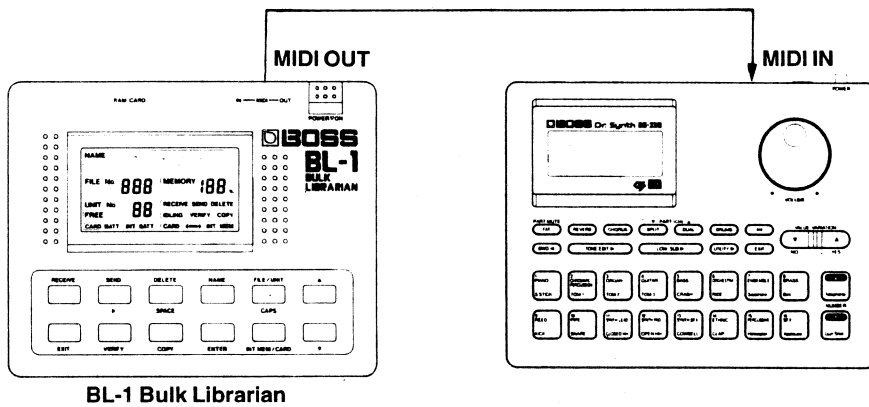

* To find out what you need to do on the BL-1 or sequencer, refer to their respective owner's manuals.

<Receiving>

The procedure for receiving data is different for Single and Multi modes, so be sure that you're in the proper mode for the data you want to receive.

[Single Mode]

Make sure that the Dr. Synth device ID and data device ID number are set the same (on some models you'll see this called the Unit Number).

- ① Check to see that you're in Single mode.
 - * If "MULTI" is lit in the display, that means you are in Multi mode. Set this to Single mode (** page 7).
- ② Press the **UTILITY ►** button until you see a display like the following.
 - * If you accidentally scroll past it, back up with the **BWD ◀** button.
 - * At some of the items, you may not be able to change the settings if you are not in the proper mode (Tone Play mode or Drum mode). In that case, switch modes before pressing the **UTILITY ►** button.

[Bulk Load]

- ③ Now, start sending data from the transmitting device (BL-1 or sequencer).
Assuming you receive the data, "Receiving" will appear in the display.
When complete you'll be returned to the "receive ready" state.
- ④ Press **EXIT** to end the procedure.

[Multi Mode]

In Multi mode, the Dr. Synth is always ready to receive data sent from an external MIDI device.

- * In either mode, the device ID numbers must match, otherwise the data cannot be transferred. Always be sure to check the device IDs before transmitting data.

MEMO



Data

■ The GM System and GS Format

And now, a little explanation about the sound module itself.

The DS-330's sound module conforms to General MIDI System Level 1 specifications and the GS Format.

□ General MIDI System



The General MIDI System is a universal group of specifications for sound generating devices which has been agreed upon by both the Japanese MIDI Standards Committee and the American MMA (MIDI Manufacturers Association).

These specifications seek to make it easier to create music data which will be compatible with a much larger range of devices, and will not be limited to equipment by a particular manufacturer or to specific models. As a result, any equipment that is equipped with sound sources which support the General MIDI System will be able to reproduce General MIDI Scores (music data created specifically for devices supporting the General MIDI System), regardless of the maker or model.

□ GS Format



The GS Format is a format for sound generating devices that has been developed by Roland. While completely satisfying all the specifications set down for the General MIDI System, this format also provides for the selection of a much larger number of sounds, and defines many of the finer details for other expressive features that can be applied during performance. Thanks to this format, any product that is equipped with GS sound sources will faithfully reproduce music data that was created under the GS Format, regardless of the particular model used. Any product which conforms to the GS Format will carry both the "GS" and "GM" logos, which means that it allows for the use of both GS music data and General MIDI Scores.

□ Standard GS Features

Number of Parts:	16
Maximum Polyphony:	24 voice minimum
Tone Specification:	Tones are selected by a combination of the usual Program Change message and a Control Change message. This is so the Tone selection method will be compatible, even if you're talking about different models or devices.
Drum Sets:	Switchable with Program Change messages
Effects:	On-board Reverb and Chorus, independently adjustable for each Part

● The Most Notes You Can Play At Once (Maximum Polyphony)

When we say "notes" here, what we are really counting is the number of "voices." A voice is an internal circuit that can make whatever sound it's told to make. The DS-330 has 28 such circuits, i.e., 28 voices. It depends on the Tone, but some use up only one voice, and some are combinations of two voices.

What this means is that you can play up to 28 notes at once with a Tone that uses only one voice...or 14 notes at once if the Tone uses two voices. And everything in between.

Now, let's say you've already got all 28 voices going at once (playing different Tones and notes), when some new data comes in saying "OK, now play this note too." Something's got to go and

the GS Format has something called a "Voice Priority" ranking for each Part to help make sure that the impending 'voice-stealing' won't completely disrupt your music.

When a new note comes in that would cause you to exceed the maximum polyphony, Voice Priority helps decide what Part will lose its voice. Naturally, the lowest priority Parts should be the first to go. So when writing music, be sure to put the most important things (like melody) in the higher priority Parts.

Voice Priority Ranking	1	2	3	4	5	6	7	8	9	10	11	12	13	14	15	16
Part	10	1	2	3	4	5	6	7	8	9	11	12	13	14	15	16

■ About Tone Variations

Here we'll explain how to use the Variations on the Dr. Synth.

● Tone Variations

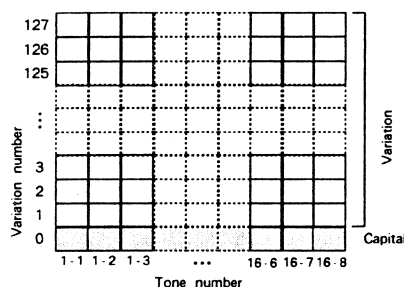

There are 128 basic sounds on the Dr. Synth which can be switched using the Bank and Number buttons. These basic sounds are called Capitals. Tones that are similar to the Capitals, but differ slightly in terms of tonal nuance and feel, are called Variations. The Capitals are assigned a Variation Number of 0, whereas the Variations themselves are assigned numbers between 1 and 127.

The relationship between Tone number (Bank/Number) and Variation number is shown in the diagram at left. Not all Variation numbers have Tones assigned to them, and if there is no Tone assigned to a given Variation number, you will be unable to select that number on the Dr. Synth.

⇒ Check the "Tone Table" (see page 87) to see which Tones have what Variations assigned to them.

● Switching Variations

The method for switching Variations on the Dr. Synth is different for Single mode and Multi mode. Check the descriptions below for what to do in each case.

◆ Switching in Single Mode

In Single mode you can freely select Variations and Capitals. For some Tone numbers (Bank/Number), when you have switched to a different Tone number after selecting a Variation, you can then set a Capital or Variation without regard to the previously selected Tone.

When you select a Variation, the name of that Variation is displayed and the "-" in the Tone number display goes out.

◆ Switching in Multi Mode

<Variations for Tones 1-1 through 15-8>

In Multi mode, a Variation is specified for each Part.

After selecting a Variation for a specific Part, if you then switch Tones for that Part, you will get the same Variation number in the new Tone. However, if you have selected a Tone that does not have a Variation at that number, you will get the Capital as a substitute.

* **When you select a Variation, the “-” in the Tone number display will go out, just as in Single mode, and when a Capital is substituted for a Variation, the “-” in the Tone number will go out as well.**

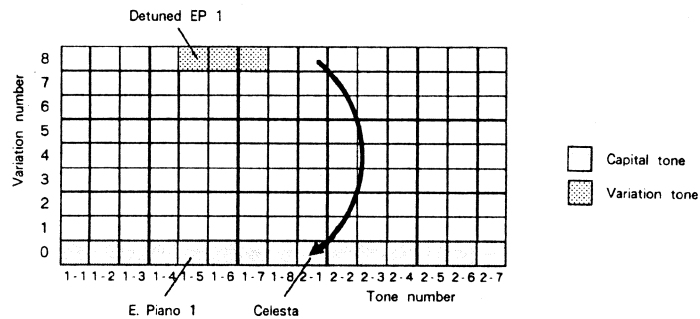

Try this example for Part 1: with Tone 1-5 selected (“E.Piano 1”), switch to Variation 8 to select “Detuned EP1”.

After that, switching to Tone 3-4 gives you “Church Org. 2”. When you switch to Tone No 2-1, there are no Variations for this Tone so the Capital, “Celesta”, is substituted.

* **This Capital substitution is not done for Variation numbers above 63. In such a case, and if there is no sound assigned to that Variation number, you’ll get no sound at all.**

<Variations for Tones 16-1 through 16-8 (SFX)>

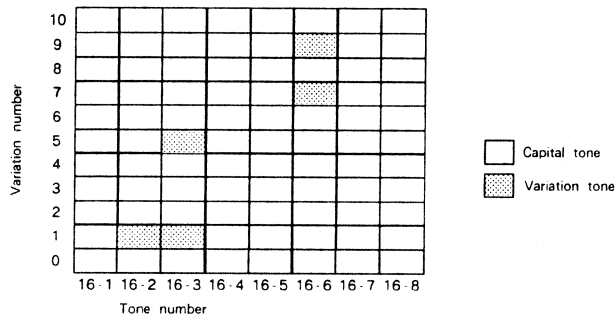

The SFX Tones are special effects that are broadly classified into different types. However, each individual effect sound is quite unique and you could hardly substitute, say, a falling rain sound for a gun shot sound!

That is why the DS-330 does not substitute a Capital if there is no Tone assigned to the selected Variation; instead, you get no sound at all.

For example, you’ll get no sound at all if you switch to Tone 16-1 when Variation 8 is selected, because there is nothing assigned to that Variation.

<Sub Capitals>

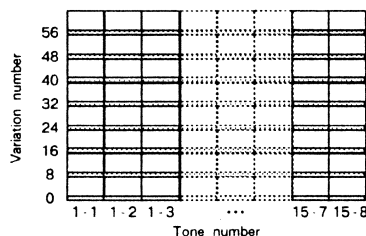

As per the diagram, Variations No. 8, 16, 24, 32, 40, 48 and 56 (all multiples of 8) are called Sub Capitals.

In some cases, when you switch to a different Tone number and a Variation number, something other than a Sub Capital is selected. If there is no Tone assigned to that Variation number, either a Sub Capital or Capital will step in as a substitute. Which Tone will be substituted depends on the Variation number.

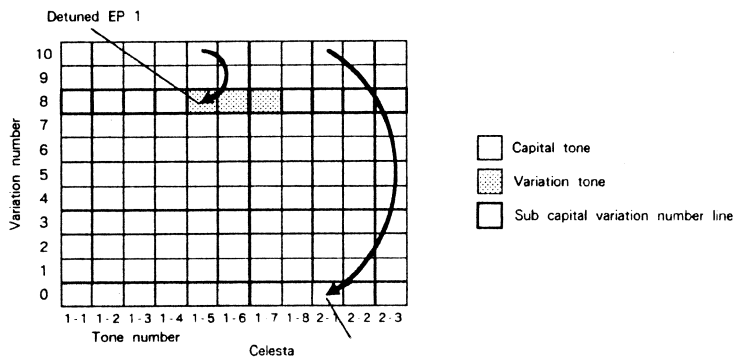

For example, when ordered by an external MIDI device to switch to Variation 10 for Tone No. 1-5, you will get instead a substitute: the next Sub Capital down from Variation 10, "Detuned EP-1". Now, if you switch Tones to 2-1, since there is no sound at the Variation 10 position there either, you will get the next Sub Capital down the list, "Celesta", as a substitute.

In this way, you'll go down the list from the selected Variation number through the Sub Capitals until you run into either a Sub Capital that has a Tone assigned to it, or a Capital Tone.

*** This Capital or Sub Capital sound substitution process happens only for Tones 1-1 through 15-8 and Variations 1 through 63.**

<Substitute Voicings for Drums>

The drum set can be changed by transmitting program change message over the MIDI channel for the drum part. The Dr. Synth has 8 different drum sets which correspond to program numbers 1, 9, 17, 25, 33, 41, 49 and 57. In addition, Dr. Synth has a system that selects one of these drum sets when a program number other than one of the eight listed received.

For example, when program number 3 is received, program number 1 ("STANDARD Set") is called up. Similarly, when program number 30 is received, program number 25 ("ELECTRONIC Set") is called up instead.

- When a program number from 50 to 128 is selected, no sound is output, since no substitution system exists.
- Set the Variation number to 0 when changing the drum set via MIDI.

■ Correspondence with Program Change Messages

The Program Change message numbers sent from an external MIDI device correspond to Tone numbers on the DS-330 as follows:

		Bank							
		1	2	3	4	5	6	7	8
Number	1	1	9	17	25	33	41	49	57
	2	2	10	18	26	34	42	50	58
	3	3	11	19	27	35	43	51	59
	4	4	12	20	28	36	44	52	60
	5	5	13	21	29	37	45	53	61
	6	6	14	22	30	38	46	54	62
	7	7	15	23	31	39	47	55	63
	8	8	16	24	32	40	48	56	64

		Bank							
		9	10	11	12	13	14	15	16
Number	1	65	73	81	89	97	105	113	121
	2	66	74	82	90	98	106	114	122
	3	67	75	83	91	99	107	115	123
	4	68	76	84	92	100	108	116	124
	5	69	77	85	93	101	109	117	125
	6	70	78	86	94	102	110	118	126
	7	71	79	87	95	103	111	119	127
	8	72	80	88	96	104	112	120	128

■ If You Think There Might Be a Problem...

If you aren't getting any sound, or things aren't working the way you expect, we suggest running through this checklist first. If none of these suggestions fix the problem, then contact your retailer or the nearest Roland Service center.

●The unit won't turn on.

Are you using the supplied AC adaptor?

●I get only very low volume or no sound at all.

Are all the connected devices turned on?

Is the VOLUME knob turned down all the way? (✎ page 14)

Do you hear any sound in the headphones when you plug them in? If so, a defective audio cable, mixer or amp may be the problem.

Has the volume perhaps been turned down by an expression pedal connected to an external MIDI device?

[Single Mode]

Have the Tone Level or Velocity settings been set near "0"? (✎ page 31, 35)

[Multi Mode]

Has the Part Level setting been turned down? (✎ page 54)

What about the Master Level setting? (✎ page 56)

Are one or more Part Mutes turned on? (✎ page 51)

Also, try a GS Initialize. (✎ page 62)

●It's completely out of tune.

Are you in tune to start with (i.e., Master Tune set properly)? (✎ page 40, 60)

Is Key Shift set properly? (✎ page 40, 59)

Have you been receiving pitch bend messages?

●I can't switch Tones.

Are you in ROM Play mode? (✎ page 13)

[Single Mode]

Have you set the MIDI channel of the external device to match that of the DS-330? (✎ page 40)

Has the Program Change Receive Switch been turned off? (✎ page 40)

Is the Map set up properly? (✎ page 43)

●I can't get the effects to work.

Is the Reverb/Chorus Effects Level set too low? (✎ page 32, 33, 55, 57, 58)

Is the Reverb/Chorus indicator light on? (✎ page 21, 50)

●The unit isn't responding to GS Reset.

Do the device ID numbers match? (✎ page 61)

Has the GS Reset Receive Switch been turned off? (✎ page 60)

●I can't get it to Bulk Dump or Bulk Load.

Do the device ID numbers on both units match? (✎ page 61)

●Something's wrong when I try to playback Roland SMF Music Data files.

Is the device ID set to 17? (✎ page 61)

Has the GS Reset Receive Switch been turned off? (✎ page 60)

■ Error Messages

When either you or the machine make a mistake during some operation, you'll see an error message displayed in the screen, indicating you what went wrong and what to do about it.

● Batteries are Used Up

[Battery Low!]

Cause: The backup batteries are exhausted.

What to do: Contact your nearest Roland Service station.

When Using Other MIDI Devices

[ChecksumErr!]

Cause: An incorrect checksum has been received.

What to do: Check the transmitted data and try the operation again. Also check for damaged or disconnected MIDI cables.

[Size Error !]

Cause: Incorrect Data Request 1 (RQ1) size has been received.

[Address Err!]

Cause: Incorrect SysEx message address has been received.

[Data Error !]

Cause: Incorrect Data Set 1 (DT1) data has been received.

[MidiOffLine!]

Cause: Possible damaged or disconnected MIDI cable(s).

What to do: Check the cables and/or connections.

■ Returning to Factory Default Settings (Initialization)

Use the following procedure if you wish to recall the Dr. Synth's factory default settings. (This is useful after you've done a lot of editing.) This procedure will initialize (reset) all settings.

● Returning to Factory Default Settings

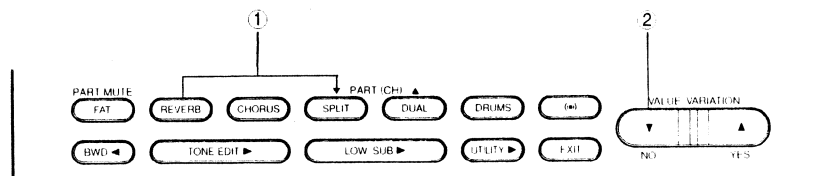

- ① Turn the unit off. Then turn the power back on while holding down the **REVERB** and **SPLIT** buttons. You'll see the following in the display:

[Init ALL ?]

- ② In response to the display, press **YES** to start the initialization, or **NO** if you change your mind and want to cancel (you'll be returned to the Play mode).

[Sure? Yes/No]

After initialization is complete, you will be returned to the Single Play mode.

Parameter Table

<< SINGLE MODE >>

● Setting for Each Tone

PARAMETER		VALUE
SPLIT	ON/OFF	ON/OFF
	SPLIT POINT	C-1 to F#9
	LOWER TONE	1-1 to 16-8
	LOWER TONE LEVEL	0 to 127
DUAL	ON/OFF	ON/OFF
	SUB TONE	1-1 to 16-8
	SUB TONE LEVEL	0 to 127
TONE LEVEL		0 to 127
FAT	ON/OFF	ON/OFF
	TYPE	Octave 1/Octave 2/ Detune 1/ Detune 2
REVERB	ON/OFF	ON/OFF
	TYPE	Room 1/Room 2/Room 3/ Hall 1/Hall 2/Plate/ Delay/Pan Delay
	TIME	0 to 127
	DELAY FEEDBACK	0 to 127
	LEVEL	0 to 127
CHORUS	ON/OFF	ON/OFF
	DELAY	0 to 127
	RATE	0 to 127
	DEPTH	0 to 127
	FEEDBACK	0 to 127
	LEVEL	0 to 127
BEND RANGE		0 to 24
MODULATION DEPTH		0 to 127
VELOCITY SENS DEPTH		0 to 127
VELOCITY SENS OFFSET		0 to 127
M/P MODE		MONO/POLY
VIBRATO	RATE	- 50 to + 50
	DEPTH	- 50 to + 50
	DELAY	- 50 to + 50
HOLD		ON/OFF
PORTAMENTO		ON/OFF
PORTAMENTO TIME		0 to 127
CUTOFF FREQUENCY		- 50 to + 50
RESONANCE		- 50 to + 50
ATTACK TIME		- 50 to + 50
DECAY TIME		- 50 to + 50
RELEASE TIME		- 50 to + 50

● All Tones and System Function Setting

PARAMETER	VALUE
KEY SHIFT	- 24 to + 24
MASTER TUNE	415.3 to 466.2Hz
MIDI RECEIVE CHANNEL	1 to 16
OMNI	ON/OFF
PROGRAM CHANGE RECEIVE SWITCH	ON/OFF
VOLUME CHANGE RECEIVE SWITCH	ON/OFF
MAP	1 to 128 → 1-1 to 16-8
DEVICE ID NUMBER	1 to 32
MODE	SINGLE/MULTI
CONTRAST	1 to 16

INITIALIZE	TONE	1-1 to 16-8
	ALL	
BULK DUMP	TONE	1-1 to 16-8
	SYSTEM	
	ALL	
BULK LOAD		

● Setting for Drum Set

PARAMETER	VALUE	
TONE LEVEL	0 to 127	
REVERB	ON/OFF	ON/OFF
	TYPE	Room 1/Room 2/Room 3/ Hall 1/Hall 2/Plate/ Delay/Pan Delay
	TIME	0 to 127
	DELAY FEEDBACK	0 to 127
	LEVEL	0 to 127
CHORUS	ON/OFF	ON/OFF
	DELAY	0 to 127
	RATE	0 to 127
	DEPTH	0 to 127
	FEEDBACK	0 to 127
	LEVEL	0 to 127

INITIALIZE : DRUM SET	
BULK DUMP : DRUM SET	

<< MULTI MODE >>

● Settings for Each Part

PARAMETER	VALUE
REVERB : ON/OFF	ON/OFF
CHORUS : ON/OFF	ON/OFF
PART MUTE	ON/OFF
PART LEVEL	0 to 127
PART PAN	Rnd, L63 to 0 to R63
REVERB : LEVEL	0 to 127
CHORUS : LEVEL	0 to 127
PART KEY SHIFT	- 24 to + 24
PART MIDI CHANNEL	1 to 16, OFF

● All Parts and System Function Settings

PARAMETER		VALUE
MASTER LEVEL		0 to 127
REVERB	TYPE	Room 1/Room 2/Room 3/ Hall 1/Hall 2/Plate/ Delay/Pan Delay
	TIME	0 to 127
	DELAY FEEDBACK	0 to 127
	LEVEL	0 to 127
CHORUS	DELAY	0 to 127
	RATE	0 to 127
	DEPTH	0 to 127
	FEEDBACK	0 to 127
	LEVEL	0 to 127

PARAMETER	VALUE
KEY SHIFT	- 24 to + 24
MASTER TUNE	415.3 to 466.2Hz
MUTE LOCK	ON/OFF
GS RESET RECEIVE SWITCH	ON/OFF
PROGRAM CHANGE RECEIVE SWITCH	ON/OFF
DEVICE ID NUMBER	1 to 32
MODE	SINGLE/MULTI
CONTRAST	1 to 16

GS INITIALIZE		
BULK DUMP	PART	1 to 16
	SYSTEM + PART	1 to 16
	ALL	

Tone Table

	#	PC#	CCO#	Tone name	V	Recommended sound range
BANK1 : Piano	1	1	0	Piano 1	1	A0 (21) — C8 (108)
	2	2	0	Piano 2	1	
	3	3	0	Piano 3	1	
	4	4	0	Honky-tonk	2	
	5	5	0	E. Piano 1	1	C2 (36) — C7 (96)
			8	Detuned EP 1	2	
	6	6	0	E. Piano 2	1	
			8	Detuned EP 2	2	
7	7	0	Harpichord	1	F2 (41) — F6 (89)	
		8	Coupled Hps.	2		
8	8	0	Clav.	1	C2 (36) — C7 (96)	
BANK2 : Chromatic Percussion	1	9	0	Celesta	1	C4 (60) — C8 (108)
	2	10	0	Glockenspiel	1	C5 (72) — C8 (108)
	3	11	0	Music Box	1	C4 (60) — C6 (84)
	4	12	0	Vibraphone	1	F3 (53) — F6 (89)
	5	13	0	Marimba	1	C3 (48) — C6 (84)
	6	14	0	Xylophone	1	F4 (65) — C7 (96)
	7	15	0	Tubular-bell	1	C4 (60) — F5 (77)
	8	16	0	Santur	1	C4 (60) — C6 (84)
BANK3 : Organ	1	17	0	Organ 1	1	C2 (36) — C7 (96)
			8	Detuned Or. 1	2	
	2	18	0	Organ 2	1	
			8	Detuned Or. 2	2	
	3	19	0	Organ 3	2	A0 (21) — C8 (108)
	4	20	0	Church Org. 1	1	
			8	Church Org. 2	2	
	5	21	0	Reed Organ	1	C2 (36) — C7 (96)
6	22	0	Accordion Fr	2	F3 (53) — F6 (89)	
7	23	0	Harmonica	1	C4 (60) — C6 (84)	
8	24	0	Bandneon	2	F3 (53) — F6 (89)	

	#	PC#	CCO#	Tone name	V	Recommended sound range	
BANK4 : Guitar	1	25	0	Nylon-str. Gt.	1	E2 (40) — C6 (84)	
			8	Ukulele	1	A3 (57) — B5 (83)	
	2	26	0	Steel str. Gt.	1	E2 (40) — C6 (84)	
			8	12 str. Gt.	2		
			16	Mandolin	1	G3 (55) — E6 (88)	
	3	27	0	Jazz Gt.	1	E2 (40) — D6 (86)	
			8	Hawaiian Gt.	1		
	4	28	0	Clean Gt.	1		
	5	29	0	Muted Gt.	1		
	6	30	0	Overdrive Gt.	1		
	7	31	0	Distortion Gt	1		
			8	Feedback Gt.	2		
8	32	0	Gt. Harmonics	1			
		8	Gt. Feedback	1			
BANK5 : Bass	1	33	0	Acoustic Bs.	1		E1 (28) — G3 (55)
	2	34	0	Fingered Bs.	1		
	3	35	0	Picked Bs.	1		
	4	36	0	Fretless Bs.	1		
	5	37	0	Slap Bass 1	1		
	6	38	0	Slap Bass 2	1		
	7	39	0	Synth Bass 1	1		
			8	Synth Bass 3	1		
8	40	0	Synth Bass 2	2			
		8	Synth Bass 4	2			

- # : Number
 PC # : Program number
 CCO # : Value of control number 0
 (GS bank select number)
 V : Number of voices
 Recommended sound range : The recommended sound range does not indicate the limit of sound production. The actual playable range extends beyond the recommended sound range.

	#	PC#	CC0#	Tone name	V	Recommended sound range
BANK6 : Strings/orchestra	1	41	0	Violin	1	G3 (55) — C7 (96)
	2	42	0	Viola	1	G3 (48) — C6 (84)
	3	43	0	Cello	1	C2 (36) — C5 (72)
	4	44	0	Contrabass	1	E1 (28) — G3 (55)
	5	45	0	Tremolo Str	1	E1 (28) — C7 (96)
	6	46	0	PizzicatoStr	1	
	7	47	0	Harp	1	B0 (23) — G7 (103)
	8	48	0	Timpani	1	C2 (36) — A3 (57)
BANK7 : Ensemble	1	49	0	Strings	1	E1 (28) — C7 (96)
			8	Orchestra	2	C1 (24) — C7 (96)
	2	50	0	Slow Strings	1	E1 (28) — C7 (96)
	3	51	0	Syn. Strings1	1	C2 (36) — C7 (96)
			8	Syn. Strings3	2	C1 (24) — C7 (96)
	4	52	0	Syn. Strings2	2	C2 (36) — C7 (96)
	5	53	0	Choir Aahs	1	
	6	54	0	Voice Oohs	1	C3 (48) — G5 (79)
7	55	0	SynVox	1	C3 (48) — C6 (84)	
8	56	0	OrchestraHit	2	C3 (48) — C5 (72)	
BANK8 : Brass	1	57	0	Trumpet	1	A # 3 (58) — A # 6 (94)
	2	58	0	Trombone	1	A # 1 (34) — D # 5 (75)
	3	59	0	Tuba	1	F1 (29) — G3 (55)
	4	60	0	MutedTrumpet	1	A # 3 (58) — A # 5 (82)
	5	61	0	French Horn	2	F2 (41) — F5 (77)
	6	62	0	Brass 1	1	
			8	Brass 2	2	
	7	63	0	Synth Brass1	2	
			8	Synth Brass3	2	C2 (36) — C7 (96)
	8	64	0	Synth Brass2	2	
8			Synth Brass4	1		

	#	PC#	CC0#	Tone name	V	Recommended sound range
BANK9 : Reed	1	65	0	Soprano Sax	1	F # 3 (54) — D # 6 (87)
	2	66	0	Alto Sax	1	C # 3 (49) — G # 5 (80)
	3	67	0	Tenor Sax	1	F # 2 (42) — D # 5 (75)
	4	68	0	Baritone Sax	1	C # 2 (37) — G # 4 (68)
	5	69	0	Oboe	1	A # 3 (58) — G6 (91)
	6	70	0	English Horn	1	E3 (52) — A5 (81)
	7	71	0	Bassoon	1	A # 1 (34) — C5 (72)
	8	72	0	Clarinet	1	D3 (50) — G6 (91)
BANK10 : Pipe	1	73	0	Piccolo	1	D5 (74) — C8 (108)
	2	74	0	Flute	1	
	3	75	0	Recorder	1	
	4	76	0	Pan Flute	1	C4 (60) — C7 (96)
	5	77	0	Bottle Blow	2	
	6	78	0	Shakuhachi	2	
	7	79	0	Whistle	1	
	8	80	0	Ocarina	1	
BANK11 : Synth lead	1	81	0	Square Wave	2	
			8	Sine Wave	1	
	2	82	0	Saw Wave	2	
	3	83	0	Syn. Calliope	2	
	4	84	0	Chiffer Lead	2	
	5	85	0	Charang	2	
	6	86	0	Solo Vox	2	
	7	87	0	5th Saw Wave	2	
8	88	0	Bass & Lead	2		
BANK12 : Synth pad etc.	1	89	0	Fantasia	2	
	2	90	0	Warm Pad	1	
	3	91	0	Polysynth	2	
	4	92	0	Space Voice	1	
	5	93	0	Bowed Glass	2	
	6	94	0	Metal Pad	2	
	7	95	0	Halo Pad	2	
	8	96	0	Sweep Pad	1	

: Number
PC # : Program number
CC0 # : Value of control number 0
(GS bank select number)
V : Number of voices
Recommended sound range : The recommended sound range does not indicate the limit of sound production. The actual playable range extends beyond the recommended sound range.

	#	PC#	CCO#	Tone name	V
BANK13 : Synth SFX	1	97	0	Ice Rain	2
	2	98	0	Soundtrack	2
	3	99	0	Crystal	2
	4	100	0	Atmosphere	2
	5	101	0	Brightness	2
	6	102	0	Goblin	2
	7	103	0	Echo Drops	1
	8	104	0	Star Theme	2
BANK14 : Ethnic	1	105	0	Sitar	1
	2	106	0	Banjo	1
	3	107	0	Shamisen	1
	4	108	0	Koto	1
			8	Taisho Koto	2
	5	109	0	Kalimba	1
	6	110	0	Bag Pipe	1
	7	111	0	Fiddle	1
8	112	0	Shanai	1	
BANK15 : Percussive	1	113	0	Tinkle Bell	1
	2	114	0	Agogo	1
	3	115	0	Steel Drums	1
	4	116	0	Woodblock	* 1
	5	117	0	Taiko	* 1
	6	118	0	Melo Tom 1	* 1
			8	Melo Tom 2	* 1
	7	119	0	Synth Drum	* 1
8			808 Tom	* 1	
8	120	0	Reverse Cym.	* 2	
BANK16 : SFX	1	121	0	Gt. FretNoise	* 1
	2	122	0	Breath Noise	2
			1	Fl. Key Click	* 1
	3	123	0	Seashore	* 1
			1	Rain	* 2
			5	Bubble	* 2
	4	124	0	Bird	* 2
	5	125	0	Telephone 1	* 1
	6	126	0	Helicopter	* 1
			7	Jetplane	* 2
			9	Burst Noise	* 2
	7	127	0	Applause	* 2
8	128	0	Gun Shot	* 1	

: Number

PC # : Program number

CCO # : Value of control number 0
(GS bank select number)

V : Number of voices

* : All tones marked by an * have an unreliable pitch. Please use a key around C4 (Key # 60). The unmarked tones use temperament and pitch of A4 (Key # 69) is 440Hz.

Drum Set Table

Note number	PC#1:STANDARD Set PC#33:JAZZ Set	PC#9:ROOM Set	PC#17:POWER Set	PC#25: ELECTRONIC Set	PC#26:TR-808 Set	PC#41: BRUSH Set	PC#49:ORCHESTRA Set
27	High Q						
28	Slap						Closed Hi-Hat [EXC1] Pedal Hi-Hat [EXC1] Open Hi-Hat [EXC1]
29				-----			Ride Cymbal
30				-----			
31	Sticks						
32	Square Click						
33				-----			
34				-----			
35	Kick Drum 2 / JAZZ KD 2					JAZZ KD 2	Concert BD 2
36	Kick Drum 1 / JAZZ KD 1		MONDO Kick	Elec BD	808 Bass Drum	JAZZ KD 1	Concert BD 1
37	Side Stick				808 Rim Shot		
38	Snare Drum 1		Gated SD	Elec SD	808 Snare Drum	Brush Tap	Concert SD
39	Hand Clap					Brush Slap	Castanets
40	Snare Drum 2			Gated SD		Brush Swirl	Concert SD
41	Low Tom 2	Room Low Tom 2	Room Low Tom 2	Elec Low Tom 2	808 Low Tom 2		Timpani F
42	Closed Hi - hat [EXC1]				808 CHH [EXC1]		Timpani F#
43	Low Tom 1	Room Low Tom 1	Room Low Tom 1	Elec Low Tom 1	808 Low Tom 1		Timpani G
44	Pedal Hi - hat [EXC1]				808 CHH [EXC1]		Timpani G#
45	Mid Tom 2	Room Mid Tom 2	Room Mid Tom 2	Elec Mid Tom 2	808 Mid Tom 2		Timpani A
46	Open Hi - hat [EXC1]				808 OHH [EXC1]		Timpani A#
47	Mid Tom 1	Room Mid Tom 1	Room Mid Tom 1	Elec Mid Tom 1	808 Mid Tom 1		Timpani B
48	High Tom 2	Room Hi Tom 2	Room Hi Tom 2	Elec Hi Tom 2	808 Hi Tom 2		Timpani c
49	Crash Cymbal 1				808 Cymbal		Timpani c#
50	High Tom 1	Room Hi Tom 1	Room Hi Tom 1	Elec Hi Tom 1	808 Hi Tom 1		Timpani d
51	Ride Cymbal 1						Timpani d#
52	Chinese Cymbal			Reverse Cymbal ★			Timpani e
53	Ride Bell						Timpani f
54	Tambourine						
55	Splash Cymbal						
56	Cowbell				808 Cowbell		
57	Crash Cymbal 2						Concert Cymbal 2
58	Vibra - slap						
59	Ride Cymbal 2						Concert Cymbal 1
60	High Bongo						
61	Low Bongo						
62	Mute High Conga				808 High Conga		
63	Open High Conga				808 Mid Conga		
64	Low Conga				808 Low Conga		
65	High Timbale						
66	Low Timbale						
67	High Agogo						
68	Low Agogo						
69	Cabasa						
70	Maracas				808 Maracas		
71	Short Hi Whistle [EXC2]						
72	Long Low Whistle [EXC2]						
73	Short Guiro [EXC3]						
74	Long Guiro [EXC3]						
75	Claves				808 Claves		
76	High Wood Block						
77	Low Wood Block						
78	Mute Cuica [EXC4]						
79	Open Cuica [EXC4]						
80	Mute Triangle [EXC5]						
81	Open Triangle [EXC5]						
82	Shaker						
83	Jingle Bell						
84				-----			
85	Castanets						
86	Mute Surdo [EXC6]						
87	Open Surdo [EXC6]						
88				-----			Applause ★

PC # : Program number (drum set number)

★ : Tones which are created by using two voices.
(All other tones are created by one voice.)

Blank : Same as the percussion sound of "STANDARD"

----- : No sound

[EXC] : Percussion sound of the same number will not be heard at the same time.

Drum Pad Table

	STANDARD set	ROOM set	POWER set	ELECTRONIC set
1	Side Stick	Side Stick	Side Stick	Side Stick
2	High Tom 1	Room High Tom 1	Room High Tom 1	Elec High Tom 1
3	Mid Tom 1	Room Mid Tom 1	Room Mid Tom 1	Elec Mid Tom 1
4	Low Tom 1	Room Low Tom 1	Room Low Tom 1	Elec Low Tom 1
5	Crash Cymbal 1	Crash Cymbal 1	Crash Cymbal 1	Crash Cymbal 1
6	Ride Cymbal 1	Ride Cymbal 1	Ride Cymbal 1	Ride Cymbal 1
7	Seashore	Seashore	Seashore	Seashore
8	Bird	Bird	Bird	Bird
Num ▲	Telephone	Telephone	Telephone	Telephone
9	Kick Drum 1	Kick Drum 1	MOND Kick	Elec BD
10	Snare Drum 1	Snare Drum 1	Gated SD	Elec SD
11	Closed Hi – hat	Closed Hi – hat	Closed Hi – hat	Closed Hi – hat
12	Open Hi – hat	Open Hi – hat	Open Hi – hat	Open Hi – hat
13	Cowbell	Cowbell	Cowbell	Cowbell
14	Hand Clap	Hand Clap	Hand Clap	Hand Clap
15	Helicopter	Helicopter	Helicopter	Helicopter
16	Applause	Applause	Applause	Applause
Num ▼	Gun Shot	Gun Shot	Gun Shot	Gun Shot
((·))	Sticks	Sticks	Sticks	Sticks

	TR – 808 set	JAZZ set	BRUSH set	ORCHESTRA set
1	808 Rim Shot	Side Stick	Side Stick	Timpani F
2	808 High Tom 1	High Tom 1	High Tom 1	Timpani G
3	808 Mid Tom 1	Mid Tom 1	Mid Tom 1	Timpani A
4	808 Low Tom 1	Low Tom 1	Low Tom 1	Timpani A #
5	808 Cymbal	Crash Cymbal 1	Crash Cymbal 1	Timpani c
6	Ride Cymbal 1	Ride Cymbal 1	Ride Cymbal 1	Timpani d
7	Seashore	Mute High Conga	Mute High Conga	Timpani e
8	Bird	High Conga	High Conga	Timpani f
Num ▲	Telephone	Low Conga	Low Conga	Concert Cymbal 2
9	808 Bass Drum	Jazz Kick D 1	Jazz Kick D 1	Concert BD 1
10	808 Snare Drum	Snare Drum 1	Brush Tap	Concert SD
11	808 CHH	Closed Hi – hat	Closed Hi – hat	Closed Hi – hat
12	808 OHH	Open Hi – hat	Open Hi – hat	Open Hi – hat
13	808 Cowbell	Cowbell	Brush Swirl	Mute Triangle
14	Hand Clap	Hand Clap	Brush Slap	Open Triangle
15	Helicopter	Low Timbale	Low Timbale	Tambourine
16	Applause	Hi Timbale	Hi Timbale	Castanets
Num ▼	Gun Shot	Maracas	Maracas	Concert Cymbal 1
((·))	Sticks	Sticks	Sticks	Sticks

Roland Exclusive Messages

1. Data Format for Exclusive Messages

Roland's MIDI implementation uses the following data format for all exclusive messages (type IV):

Byte	Description
F0H	Exclusive status
41H	Manufacturer ID (Roland)
DEV	Device ID
MDL	Model ID
CMD	Command ID
[BODY]	Main data
F7H	End of exclusive

= MIDI status : F0H, F7H

An exclusive message must be flanked by a pair of status codes, starting with a Manufacturer-ID immediately after F0H (MIDI version 1.0).

= Manufacturer ID : 41H

The Manufacturer-ID identifies the manufacturer of a MIDI instrument that triggers an exclusive message. Value 41H represents Roland's Manufacturer-ID.

= Device ID : DEV

The Device-ID contains a unique value that identifies the individual device in the multiple implementation of MIDI instruments. It is usually set to 00H - 0FH, a value smaller by one than that of a basic channel, but value 00H - 1FH may be used for a device with multiple basic channels.

= Model ID : MDL

The Model-ID contains a value that uniquely identifies one model from another. Different models, however, may share an identical Model-ID if they handle similar data.

The Model-ID format may contain 00H in one or more places to provide an extended data field. The following are examples of valid Model-IDs, each representing a unique model:

01H
02H
03H
00H, 01H
00H, 02H
00H, 00H, 01H

= Command ID : CMD

The Command-ID indicates the function of an exclusive message. The Command-ID format may contain 00H in one or more places to provide an extended data field. The following are examples of valid Command-IDs, each representing a unique function:

01H
02H
03H
00H, 01H
00H, 02H
00H, 00H, 01H

= Main data : BODY

This field contains a message to be exchanged across an interface. The exact data size and contents will vary with the Model-ID and Command-ID.

2. Address-mapped Data Transfer

Address mapping is a technique for transferring messages conforming to the data format given in Section 1. It assigns a series of memory-resident records: waveform and tone data, switch status, and parameters, for example - to specific locations in a machine-dependent address space, thereby allowing access to data residing at the address a message specifies.

Address-mapped data transfer is therefore independent of models and data categories. This technique allows use of two different transfer procedures: one-way transfer and handshake transfer.

= One way transfer procedure (See Section 3 for details.)

This procedure is suited for the transfer of a small amount of data. It sends out an exclusive message completely independent of a receiving device status.

Connection Diagram

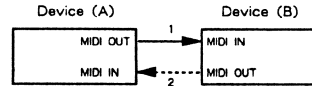

Connection at point 2 is essential for "Request data" procedures. (See Section 3.)

= Handshake transfer procedure (This device does not cover this procedure)

This procedure initiates a predetermined transfer sequence (handshaking) across the interface before data transfer takes place. Handshaking ensures that reliability and transfer speed are high enough to handle a large amount of data.

Connection Diagram

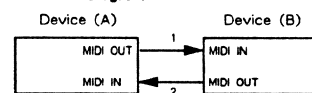

Connection at points 1 and 2 is essential.

Notes on the above two procedures

- * There are separate Command-IDs for different transfer procedures.
- * Devices A and B cannot exchange data unless they use the same transfer procedure, share identical Device-ID and Model ID, and are ready for communication.

3. One way Transfer Procedure

This procedure sends out data all the way until it stops and is used when the messages are so short that answerbacks need not be checked. For long messages, however, the receiving device must acquire each message in time with the transfer sequence, which inserts intervals of at least 20 milliseconds in between.

Types of Messages

Message	Command ID
Request data 1	RQ1 (11H)
Data set 1	DT1 (12H)

= Request data = 1 : RQ1 (11H)

This message is sent out when there is a need to acquire data from a device at the other end of the interface. It contains data for the address and size that specify designation and length, respectively, of data required.

On receiving an RQ1 message, the remote device checks its memory for the data address and size that satisfy the request. If it finds them and is ready for communication, the device will transmit a "Data set 1 (DT1)" message, which contains the requested data. Otherwise, the device will send out nothing.

Byte	Description
F0H	Exclusive status
41H	Manufacturer ID (Roland)
DEV	Device ID
MDL	Model ID
11H	Command ID
aaH	Address MSB
⋮	⋮
⋮	⋮
⋮	⋮
⋮	LSB
ssH	Size MSB
⋮	⋮
⋮	⋮
⋮	LSB
sum	Check sum
F7H	End of exclusive

Roland Exclusive Messages

- * The size of the requested data does not indicate the number of bytes that will make up a DT1 message, but represents the address fields where the requested data resides.
- * Some models are subject to limitations in data format used for a single transaction. Requested data, for example, may have a limit in length or must be divided into predetermined address fields before it is exchanged across the interface.
- * The same number of bytes comprises address and size data, which, however, vary with the Model ID.
- * The error checking process uses a checksum that provides a bit pattern where the least significant 7 bits are zero when values for an address, size, and that checksum are summed.

= Data set 1 : DT1 (12H)

This message corresponds to the actual data transfer process. Because every byte in the data is assigned a unique address, a DT1 message can convey the starting address of one or more data as well as a series of data formatted in an address-dependent order.

The MIDI standards inhibit non-real time messages from interrupting an exclusive one. This fact is inconvenient for the devices that support a "soft-through" mechanism. To maintain compatibility with such devices, Roland has limited the DT1 to 256 bytes so that an excessively long message is sent out in separate segments.

Byte	Description
F0H	Exclusive
41H	Manufacturer ID (Roland)
DEV	Device ID
MDL	Model ID
12H	Command ID
aaH	Address MSB
⋮	⋮
	LSB
ddH	Data
⋮	⋮
sum	Check sum
F7H	End of exclusive

- * A DT1 message is capable of providing only the valid data among those specified by an RQ1 message.
- * Some models are subject to limitations in data format used for a single transaction. Requested data, for example, may have a limit in length or must be divided into predetermined address fields before it is exchanged across the interface.
- * The number of bytes comprising address data varies from one Model ID to another.
- * The error checking process uses a checksum that provides a bit pattern where the least significant 7 bits are zero when values for an address, size, and that checksum are summed.

= Example of Message Transactions

- Device A sending data to Device B
Transfer of a DT1 message is all that takes place.

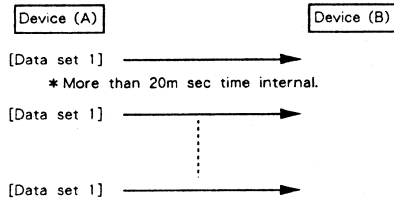

- Device B requesting data from Device A
Device B sends an RQ1 message to Device A. Checking the message, Device A sends a DT1 message back to Device B.

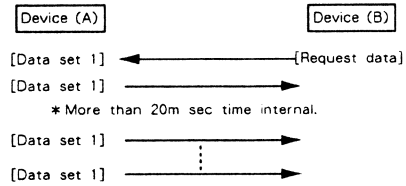

1. Receive data

■ Channel Voice Message

● Note off

Status	Second	Third
8nH	kkH	vvH
9nH	kkH	00H

n=MIDI channel number :0H - FH (ch.1 - ch.16)
kk=Note number :00H - 7FH (0 - 127)
vv=Velocity :00H - 7FH (0 - 127)

- * Ignored when "Rx.Note message = OFF".
- * In the drum part, recognized when "Rx.Note off = ON" at each instrument.
- * Velocity is ignored.

● Note on

Status	Second	Third
9nH	kkH	vvH

n=MIDI channel number :0H - FH (ch.1 - ch.16)
kk=Note number :00H - 7FH (0 - 127)
vv=Velocity :01H - 7FH (1 - 127)

- * Ignored when "Rx.Note message = OFF".
- * In the drum part, ignored when "Rx.Note on = OFF" at each instrument.

● Polyphonic key pressure

Status	Second	Third
AnH	kkH	vvH

n=MIDI channel number :0H - FH (ch.1 - ch.16)
kk=Note number :00H - 7FH (0 - 127)
vv=Value :00H - 7FH (0 - 127)

- * Ignored when "Rx.Polyphonic key pressure = OFF".

● Control change

- * All control change messages except channel mode messages are ignored when "Rx.Control change = OFF".
- * The value set by control change messages won't be reset by receiving new Program Change messages.

○ Bank select

Status	Second	Third
BnH	00H	mmH
BnH	20H	llH

n=MIDI channel number :0H - FH (ch.1 - ch.16)
mm,ll=Bank number :00H,00H - 7FH,7FH (bank1 - bank16384)

- * The LSB 7bit is ignored(value=00H).
- * "Bank select" is suspended until receiving "Program change".
To select a timbre of another bank, you have to send Bank select(mm,ll) first and then send the Program change message.
- * The "Variation number" of the DS-330 is defined as the decimal number of the value of MSB(Control change number 00H) of the Bank select.
- * Ignored when "Rx.Program Change = OFF".
- * Ignored when "PRG RX: Off".

○ Modulation

Status	Second	Third
BnH	01H	vvH

n=MIDI channel number :0H - FH (ch.1 - ch.16)
vv=Modulation depth :00H - 7FH (0 - 127)

- * Ignored when "Rx.Modulation = OFF".

○ Portamento time

Status	Second	Third
BnH	05H	vvH

n=MIDI channel number :0H - FH (ch.1 - ch.16)
vv=Portamento time :00H - 7FH (0 - 127)

- * The Portamento time value changes the rate of pitch change at portamento on.

○ Data entry

Status	Second	Third
BnH	06H	mmH
BnH	26H	llH

n=MIDI channel number :0H - FH (ch.1 - ch.16)
mm,ll=Value of the parameter specified with RPN and/or NRPN

○ Volume

Status	Second	Third
BnH	07H	vvH

n=MIDI channel number :0H - FH (ch.1 - ch.16)
vv=Volume :00H - 7FH (0 - 127)

- * The Volume value changes the volume of the specified channel(part).
- * Ignored when "Rx.Volume = OFF".
- * Ignored when "VOL RX : OFF".

○ Panpot

Status	Second	Third
BnH	0AH	vvH

n=MIDI channel number :0H - FH (ch.1 - ch.16)
vv=Panpot :00H - 40H - 7FH (Left - Center - Right)

- * Resolution of panpot is approx. 7bit (127 steps).
- * In drums part, it works for all over the mapped drum instruments relatively.
- * Ignored when "Rx.Panpot = OFF".

○ Expression

Status	Second	Third
BnH	0BH	vvH

n=MIDI channel number :0H - FH (ch.1 - ch.16)
vv=Expression :00H - 7FH (0 - 127)

- * The Expression value changes the volume of the specified channel(part).
- * Ignored when "Rx.Expression = OFF".

○Hold1

Status	Second	Third
BnH	40H	vvH

n=MIDI channel number :0H - FH (ch.1 - ch.16)
 vv=Control Value :00H - 7FH (0 - 127)
 0-63=OFF 64-127=ON

- * Ignored when "Rx.Hold1 = OFF".
- * Ignored when "HOLD1 : OFF".

○Portamento

Status	Second	Third
BnH	41H	vvH

n=MIDI channel number :0H - FH (ch.1 - ch.16)
 vv=Control Value :00H - 7FH (0 - 127) 0=OFF

- * Ignored when "Rx.Portamento = OFF".

○Sostenuto

Status	Second	Third
BnH	42H	vvH

n=MIDI channel number :0H - FH (ch.1 - ch.16)
 vv=Control Value :00H - 7FH (0 - 127)
 0-63=OFF 64-127=ON

- * Ignored when "Rx.Sostenuto = OFF".

○Soft

Status	Second	Third
BnH	43H	vvH

n=MIDI channel number :0H - FH (ch.1 - ch.16)
 vv=Control Value :00H - 7FH (0 - 127)
 0-63=OFF 64-127=ON

- * Ignored when "Rx.Soft = OFF".

○Effect1 depth(Reverb send level)

Status	Second	Third
BnH	5BH	vvH

n=MIDI channel number :0H - FH (ch.1 - ch.16)
 vv=Reverb send depth :00H - 7FH (0 - 127)

- * You can adjust the reverb send level of a specified channel(part).

○Effect3 depth(Chorus send level)

Status	Second	Third
BnH	5DH	vvH

n=MIDI channel number :0H - FH (ch.1 - ch.16)
 vv=Chorus send depth :00H - 7FH (0 - 127)

- * You can adjust the chorus send level of a specified channel(part).

○NRPN MSB/LSB

Status	Second	Third
BnH	63H	mmH
BnH	62H	llH

n=MIDI channel number :0H - FH (ch.1 - ch.16)
 mm=MSB of the specified parameter by NRPN
 ll=LSB of the specified parameter by NRPN

- * Ignored when "Rx.NRPN = OFF".

NRPN

NRPN (Non Registered Parameter Number) is an expanded control change message.
 Each function of an NRPN is described by the individual manufactures.
 Set NRPN MSB/LSB before sending data entry.

You can change the value of several sound parameters.

There are relative change(from preset) parameters and absolute change parameters.

The relative change parameters may have limits on the effect (depend upon the timbres) even if the value is between 0EH-72H.

The NRPN parameters of the DS-330 are as shown below:

NRPN	Data entry	Description
MSB LSB	MSB	
01H 08H	mmH	Vibrate rate relative change on specified channel mm: 0EH-40H-72H (-50 - 0 - +50)
01H 09H	mmH	Vibrate depth relative change on specified channel mm: 0EH-40H-72H (-50 - 0 - +50)
01H 0AH	mmH	Vibrate delay relative change on specified channel mm: 0EH-40H-72H (-50 - 0 - +50)
01H 20H	mmH	TVF cutoff frequency relative change on specified channel mm: 0EH-40H-72H (-50 - 0 - +50)
01H 21H	mmH	TVF resonance relative change on specified channel mm: 0EH-40H-72H (-50 - 0 - +50)
01H 63H	mmH	TVF&TVA Env. Attack time relative change on specified channel mm: 0EH-40H-72H (-50 - 0 - +50)
01H 64H	mmH	TVF&TVA Env. Decay time relative change on specified channel mm: 0EH-40H-72H (-50 - 0 - +50)
01H 66H	mmH	TVF&TVA Env. Release time relative change on specified channel mm: 0EH-40H-72H (-50 - 0 - +50)
18H rrH	mmH	Pitch coarse of drum instrument relative change on specified drum instrument rr: key number of drum instrument mm: 00H-40H-7FH (-64 - 0 - +63 semitone)
1AH rrH	mmH	TVA level of drum instrument absolute change on specified drum instrument rr: key number of drum instrument mm: 00H-7FH (zero - maximum)
1CH rrH	mmH	Panpot of drum instrument absolute change on specified drum instrument rr: key number of drum instrument mm: 00H,01H-40H-7FH (Random, Left-Center-Right)
1DH rrH	mmH	Reverb send level of drum instrument absolute change on specified drum instrument rr: key number of drum instrument mm: 00H-7FH (zero - maximum)
1EH rrH	mmH	Chorus send level of drum instrument absolute change on specified drum instrument rr: key number of drum instrument mm: 00H-7FH (zero - maximum)

- * Data entry LSB is ignored.

- * The relative change means that the parameter value(e.g. -50-0-+50) will add to the preset value.

- * The absolute change means that the parameter value will be replaced by the received value.

- * The effective range of value for these parameters may more narrow than the range shown above depend on the timbres.

○RPN MSB/LSB

Status	Second	Third
BnH	65H	mmH
BnH	64H	llH

n=MIDI channel number :0H - FH (ch.1 - ch.16)

mm=MSB of the specified parameter by RPN

ll=MSB of the specified parameter by RPN

* Ignored when "Rx.RPN = OFF".

RPN

RPN (Registered Parameter Number) is the expanded control change message. Each function of RPN is described by MIDI.

You can change the value of RPN parameters. First, set RPN MSB/LSB before sending data entry.

The DS-330 can receive Pitch bend sensitivity(RPN#0), Master fine tuning(RPN#1), Master course tuning(RPN#2) and RPN reset(RPN#16383).

RPN MSB LSB	Data entry MSB LSB	Description
00H 00H	mmH ---	Pitch bend sensitivity mm: 00H-18H (0 - 24 semitone) ll: ignored (Up to 2 octaves, power on default is two semitones)
00H 01H	mmH llH	Master fine tuning mm,ll: 00H,00H-40H,00H-7FH,7FH (-8192*100/8192 - 0 - +8191*100/8192 cent)
00H 02H	mmH ---	Master coarse tuning mm: 28H-40H-58H (-24 - 0 - +24 semitone) ll: ignored
7FH 7FH	--- ---	RPN reset Return to no specified parameter of RPN and NRPN. Current setting value is not changed. mm,ll: ignored

●Program change

Status	Second
CnH	ppH

n=MIDI channel number :0H - FH (ch.1 - ch.16)

pp=Program number :00H - 7FH (prog.1 - prog.128)

* The voices already on before receiving a program change message aren't affected.

The tone will change to the new voice after the program change is received.

* Ignored when "Rx.Program change = OFF".

* Ignored when "PRG RX : OFF".

* In the drum part, some Models may not receive Program change message when the Bank is 129 - 16384 (the value of the control change 00H is not 00H).

●Channel pressure

Status	Second
DnH	vvH

n=MIDI channel number :0H - FH (ch.1 - ch.16)

vv=Value :00H - 7FH (0 - 127)

* Ignored when "Rx.Channel pressure = OFF".

●Pitch bend change

Status	Second	Third
EnH	llH	mmH

n=MIDI channel number :0H - FH (ch.1 - ch.16)

mm,ll=Value:00H,00H - 40H,00H - 7FH,7FH(-8192 - 0 - +8191)

* Ignored when "Rx.Pitch bend change = OFF"

■Channel Mode Message

●All sounds off

Status	Second	Third
BnH	78H	00H

n=MIDI channel number :0H - FH (ch.1 - ch.16)

* When "All sounds off" is received, all sounds on specified channel turn off immediately. However, the state of channel messages does not change.

●Reset all controllers

Status	Second	Third
BnH	79H	00H

n=MIDI channel number :0H - FH (ch.1 - ch.16)

* When "reset all controllers" is received, the controller value of a specified channel returns to the default value.

Controller	Value
Pitch bend change	±0(Center)
Polyphonic key pressure	0(off)
Channel pressure	0(off)
Modulation	0 (off)
Expression	127(maximum)
Hold1	0(off)
Portamento	0(off)
Sostenuto	0(off)
Soft	0(off)
RPN	No specified parameter, value is not changed.
NRPN	No specified parameter, value is not changed.

●All notes off

Status	Second	Third
BnH	7BH	00H

n=MIDI channel number :0H - FH (ch.1 - ch.16)

* When "All notes off" is received, all notes are turned off in the specified channel. However, sound continues when hold1 and/or sostenuto is on.

●OMNI OFF

Status	Second	Third
BnH	7CH	00H

n=MIDI channel number :0H - FH (ch.1 - ch.16)

* OMNI OFF is only recognized as "all notes off". Mode doesn't change.

●OMNI ON

Status	Second	Third
BnH	7DH	00H

n=MIDI channel number :0H - FH (ch.1 - ch.16)

* OMNI ON is only recognized as "all notes off". Mode doesn't change (OMNI OFF remains).

●MONO

Status	Second	Third
BnH	7EH	mmH

n=MIDI channel number :0H - FH (ch.1 - ch.16)

mm=number of mono :00H - 10H (0 - 16)

* MONO is recognized as "all sounds off". The specified channel turns to Mode4 (m=1), even if mm is not equal to 1 (mm is ignored).

●POLY

Status	Second	Third
BnH	7FH	00H

n=MIDI channel number :0H - FH (ch.1 - ch.16)

- * POLY is recognized as "all sounds off". The specified channel turns to Mode3.

■System Realtime Message

●Active sensing

Status
FEH

- * Having received an "active sensing" message, the DS-330 expects to receive additional active sensing message within 300 ms. If the interval is over 420 milli-second, the DS-330 execute "All sounds off", "All notes off" and "Reset all controllers" and returns to normal operation.(Monitoring of active sensing messages will terminate.)

■System Exclusive Message

Status	Data
F0H	iiH,ddH.....eeH
F7H	

F0H :System exclusive
 ii=ID number :41H (65)
 dd.....ee=data :00H-7FH (0-127)
 F7H :EOX (End of Exclusive/System common)

- * The DS-330 can receive mode change, data request(RQ1) and data set(DT1).
- * Refer to section 3, 4.

■System Exclusive Message of Mode Change

●GS reset

Status	Data Byte	Status
F0H	41H, 10H, 42H, 12H, 40H, 00H, 7FH, 00H, 41H	F7H

Byte	Description
F0H	Exclusive status
41H	Manufacturer's ID(Roland)
10H	Device ID(UNIT#=17)
42H	Model ID(GS)
12H	Command ID(DT1)
40H	Address MSB
00H	:
7FH	Address LSB
00H	Data(GS reset)
41H	Check sum
F7H	EOX(End of exclusive)

- * Receiving this message, all the internal parameters are set to the GS default setting, and can receive GS MIDI data correctly.
- * It takes about 50ms to execute this message. Please take a rest before the next messages.
- * Ignored when "GS Reset RX: Off".
- * This message can be received when the unit is either in the Single or Multi mode. Receiving this message, the unit will be turned to the Multi mode.

●Turn General MIDI System On

Status	Data Byte	Status
F0H	7EH, 7FH, 09H, 01H	F7H

Byte	Description
F0H	Exclusive status
7EH	ID number(Universal non-real time message)
7FH	ID of target device(Broadcast)
09H	sub-ID#1(General MIDI message)
01H	sub-ID#2(General MIDI On)
F7H	EOX(End of exclusive)

- * Receiving this message, all the internal parameters are set to the General MIDI Level 1 default setting even if in the any mode, and can play the General MIDI score (level 1) correctly.
- * It takes about 50ms to execute this message. Please take a rest before the next messages.
- * Ignored when "GS Reset RX: Off".
- * This message can be received when the unit is either in the Single or Multi mode. Receiving this message, the unit will be turned to the Multi mode.

2.Transmit data

■Channel Voice Message

●NOTE OFF

Status	Second	Third
9nF	kkH	vvH

n=MIDI :0H-FH(ch.1-ch.16)
 k=note number :00H-7FH(0-127)
 vv=velocity :00H(H)

- * Only SINGLE DRUM mode.

●NOTE ON

Status	Second	Third
9nF	kkH	vvH

n=MIDI :0H-FH(ch.1-ch.16)
 k=note number :00H-7FH(0-127)
 vv=velocity :01H-7FH(1-127)

- * Only SINGLE DRUM mode.

●Program change

Status	Second
CnH	ppH

n=MIDI channel number :01H - FH (ch.1 - ch.16)
 pp=Program number :00H - 7FH (prog.1 - prog.128)

- * Only SINGLE mode.

■System Realtime Message

●Active sensing

Status
FEH

- * Transmit at about 250 milli-second intervals.

■System Exclusive Message

Status	Data
F0H	iiH,ddH.....eeH
F7H	

F0H :System exclusive
 ii=ID number :41H (65)
 dd.....ee=data :00H-7FH (0-127)
 F7H :EOX (End of Exclusive/System common)

- * Refer to section 3, 4.

3.Exclusive communications

- * The DS-330 can transmit and receive patch parameters using system exclusive messages.
- * Model ID of DS-330 is 55H(DS-330) and 42H(GS). Device ID is 00H - 1FH.

■ One way communication

● Request data 1 RQ1 (11H)

Byte	Description
F0H	Exclusive status
41H	Manufacturer's ID(Roland)
dev	Device ID(dev: 00H - 1FH)
mdl	Model ID(mdl: 55H or 42H)
11H	Command ID(RQ1)
aaH	Address MSB
bbH	:
ccH	Address LSB
ssH	Size MSB
ttH	:
uuH	Size LSB
sum	Check sum
F7H	EOX(End of exclusive)

● Data set 1 DT1 (12H)

Byte	Description
F0H	Exclusive status
41H	Manufacturer's ID(Roland)
dev	Device ID(dev: 00H - 1FH)
mdl	Model ID(mdl: 55H or 42H)
12H	Command ID(DT1)
aaH	Address MSB
bbH	Address
ccH	Address LSB
ddH	Data
:	:
ddH	Data
sum	Check sum
F7H	EOX(End of exclusive)

4. Parameter address map (Model ID=55H or 42H)

The address and size are described with 7-bit hexadecimal.

Address	MSB	LSB
Binary	0aaa aaaa	0bbb bbbb 0ccc cccc
Hexadecimal	AA	BB CC

Size	MSB	LSB
Binary	0sss ssss	0uuu uuuu
Hexadecimal	SS	TT UU

■ Parameter base address

There are two types of the DS-330 exclusive message. One is an individual parameter communication, the other is a bulk dump communication.

The address map of the exclusive communication is outlined below:

(Model ID = 55H)

Address	Block	Sub Block	Notes
20 00 00	TRIDI MAP SINGLE		Bulk
	(TONE parameters)		
20 01 00	SYSTEM SINGLE		Bulk
	(TONE DRUM parameters)		
21 00 00	TEMPORARY		Bulk
	(SINGLE TONE parameters)		

20 00 00				
	(SINGLE TONE parameters)	(TONE 1 - 4 parameters)		Bulk
23 00 00				
	(SINGLE DRUM parameters)	(TONE 16 - 8 parameters)		Bulk

(Model ID = 42H)

Address	Block	Sub Block	Notes
40 00 00	System		Individual
40 01 00	Patch parameters	Patch common	Individual
		Patch block 0	
		Patch block F	
40 30 00	Information		Individual
41 00 00	Drum setup parameters	Drum map name	Individual
		Drum inst parameters	
48 00 00	Bulk dump	System parameters	Bulk
		Patch common	
		Patch block 0	
		Patch block F	
49 00 00	Bulk dump	Drum inst parameters	Bulk
		Drum map name	

Notes: Using address of individual parameter

One system exclusive message "F0....F7" can only have one parameter.

You cannot use any address having "#" for the top address in a system exclusive message.

<MODEL ID = 55H> SINGLE MODE

[SINGLE TONE/DRUM MODE SYSTEM PARAMETERS]

Address(H)	SIZE(H)	Data(H)	Parameter	Description	Default Value (H)
20 00 00	00 01 00	00 - 07	MIDI MAP		same as RX Program No.
:					
7F					
20 01 00	00 00 04	0018-07E8	TUNE	-100.0 - +100.0 [cent]	00 04 00 00
01#					
02#					
03#					
20 01 04	00 00 01	28 - 58	KFY SHIFT	-24 - +24[semitones]	40
20 01 05	00 00 01	00 - 01	RX PROGRAM CG	OFF/ON	01
20 01 06	00 00 01	00 - 01	RX VOLUME	OFF/ON	01
20 01 07	00 00 01	00 - 07	BANK 1	1-8	00
20 01 08	00 00 01	00 - 07	BANK 2	1-8	00
:					
20 01 16	00 00 01	00 - 07	BANK 16	1-8	00

[SINGLE TONE MODE TEMPORARY PARAMETERS]

Address(H)	SIZE(H)	Data(H)	Parameter	Description	Default Value (H)
21 00 00	00 00 28	00 - 7E	SPLIT POINT	C-1 - F#9	34
21 00 01		00 - 7F	LOW TONE NUMBER	0-127	-
21 00 02		00 - 7F	LOW LEVEL	0-127	7F
21 00 03		00 - 7F	SUB TONE NUMBER	0-127	-
21 00 04		00 - 7F	SUB LEVEL	0-127	50
21 00 05		00 - 02	SPLIT MODE	00:OFF 01:SPLIT 02:DUAL	00
21 00 06		00 - 01	FAT ON	OFF/ON	00
21 00 07		00 - 7F	tone level	0-127	64
21 00 08		00 - 03	FAT MODE	0-3	-
21 00 09		00 - 07	REVERB CHARACTER	0-7	05
21 00 0A		00 - 7F	REVERB TIME	0-127	5A
21 00 0B		00 - 7F	DELAY FEEDBACK	0-127	1E
21 00 0C		00 - 7F	CHORUS DELAY	0-127	05
21 00 0D		00 - 7F	CHORUS RATE	0-127	05
21 00 0E		00 - 7F	CHORUS DEPTH	0-127	0A
21 00 0F		00 - 7F	CHORUS FEEDBACK	0-127	00
21 00 10		00 - 01	REVERB ON	OFF/ON	01
21 00 11		00 - 01	CHORUS ON	OFF/ON	-
21 00 12		00 - 7F	REVERB LEVEL	0-127	50
21 00 13		00 - 7F	CHORUS LEVEL	0-127	64
21 00 14		40 - 58	BFND RANG	0 - +24[semitones]	42
21 00 15		00 - 7F	MODULATION DEPTH	0-127	0A
21 00 16		00 - 7F	VELOCITY DEPTH	0-127	40
21 00 17		00 - 7F	VELOCITY OFFSET	0-127	40
21 00 18		00 - 01	MONO/POLY MODE	MONO/POLY	01
21 00 19		0E - 72	VIBRATO RATE	-50 - +50	40
21 00 1A		0E - 72	VIBRATO DEPTH	-50 - +50	40
21 00 1B		0E - 72	VIBRATO DELAY	-50 - +50	40
21 00 1C		00 - 01	HOLD 1 ON	OFF/ON	01
21 00 1D		00 - 01	PORTAMENTO ON/OFF	OFF/ON	00
21 00 1E		00 - 7F	PORTAMENTO TIME	0-127	1E
21 00 1F		0E - 72	CUT OFF FREQUENCY	-50 - +50	40
21 00 20		0E - 72	RESONANCE	-50 - +50	40
21 00 21		0E - 72	ATTACK TIME	-50 - +50	40
21 00 22		0E - 72	DECAY TIME	-50 - +50	40
21 00 23		0E - 72	RELEASE TIME	-50 - +50	40
21 00 24		00 - 02	VARIATION NUMBER	0-2	00
21 00 25		00 - 02	LOW VARIATION NUMBER	0-2	00
21 00 26		00 - 02	SLB VARIATION NUMBER	0-2	00
21 00 27		00 - 7F	TEMPORARY TONE NUMBER	1-1 - 16-8	00

[SINGLE TONE MODE PARAMETERS]

Address(H)	SIZE(H)	Data(H)	Parameter	Description	Default Value (H)
22 00 00	00 00 27		TONE 1-1	table*	
:					
26					
22 01 00	00 00 27		TONE 1-2		
:					
26					
:					
22 7F 00	00 00 27		TONE 16-8		
table*					
OFFSET ADDRESS					
00 00 00	00 00 28	00 - 7E	SPLIT POINT	C-1 - F#9	34
00 00 01		00 - 7F	LOW TONE NUMBER	0-127	-
00 00 02		00 - 7F	LOW LEVEL	0-127	7F
00 00 03		00 - 7F	SUB TONE NUMBER	0-127	-
00 00 04		00 - 7F	SUB LEVEL	0-127	50
00 00 05		00 - 02	SPLIT MODE	00:OFF 01:SPLIT 02:DUAL	00
00 00 06		00 - 01	FAT ON	OFF/ON	00
00 00 07		00 - 7F	TONE LEVEL	0-127	64
00 00 08		00 - 03	FAT MODE	0-3	-
00 00 09		00 - 07	REVERB TYPE	0-7	05
00 00 0A		00 - 7F	REVERB TIME	0-127	5A
00 00 0B		00 - 7F	DELAY FEEDBACK	0-127	1E
00 00 0C		00 - 7F	CHORUS DELAY	0-127	05
00 00 0D		00 - 7F	CHORUS RATE	0-127	05
00 00 0E		00 - 7F	CHORUS DEPTH	0-127	0A
00 00 0F		00 - 7F	CHORUS FEEDBACK	0-127	00
00 00 10		00 - 01	REVERB ON	OFF/ON	01
00 00 11		00 - 01	CHORUS ON	OFF/ON	-
00 00 12		00 - 7F	REVERB LEVEL	0-127	50
00 00 13		00 - 7F	CHORUS LEVEL	0-127	64
00 00 14		40 - 58	BEND RANG	0 - +24[semitones]	42
00 00 15		00 - 7F	MODULATION DEPT	0-127	0A
00 00 16		00 - 7F	VELOCITY DEPTH	0-127	40
00 00 17		00 - 7F	VELOCITY OFFSET	0-127	40
00 00 18		00 - 01	MONO/POLY MODE	MONO/POLY	01
00 00 19		0E - 72	VIBRATO RATE	-50 - +50	40
00 00 1A		0E - 72	VIBRATO DEPTH	-50 - +50	40
00 00 1B		0E - 72	VIBRATO DELAY	-50 - +50	40
00 00 1C		00 - 01	HOLD 1 ON	OFF/ON	01
00 00 1D		00 - 01	PORTAMENTO ON/OFF	OFF/ON	00
00 00 1E		00 - 7F	PORTAMENTO TIME	0-127	1E
00 00 1F		0E - 72	CUT OFF FREQUENCY	-50 - +50	40
00 00 20		0E - 72	RESONANCE	-50 - +50	40
00 00 21		0E - 72	ATTACK TIME	-50 - +50	40
00 00 22		0E - 72	DECAY TIME	-50 - +50	40
00 00 23		0E - 72	RELEASE TIME	-50 - +50	40
00 00 24		00 - 02	VARIATION NUMBER	0-2	00
00 00 25		00 - 02	LOW VARIATION NUMBER	0-2	00
00 00 26		00 - 02	SUB VARIATION NUMBER	0-2	00

[SINGLE DRUM MODE PARAMETERS]

Address(H)	SIZE(H)	Data(H)	Parameter	Description	Default Value (H)
23 00 00	00 00 0C	00 - 7F	DRUM LEVEL	0-127	64
23 00 01		00 - 07	DRUM REVERB TYPE	0-7	05
23 00 02		00 - 7F	DRUM REVERB TIME	0-127	5A
23 00 03		00 - 7F	DRUM DELAY FEEDBACK	0-127	1E
23 00 04		00 - 7F	DRUM CHORUS DELAY	0-127	05
23 00 05		00 - 7F	DRUM CHORUS RATE	0-127	05
23 00 06		00 - 7F	DRUM CHORUS DEPTH	0-127	0A
23 00 07		00 - 7F	DRUM CHORUS FEEDBACK	0-127	00
23 00 08		00 - 01	DRUM REVERB ON	OFF/ON	01
23 00 09		00 - 01	DRUM CHORUS ON	OFF/ON	00
23 00 0A		00 - 7F	DRUM REVERB LEVEL	0-127	50
23 00 0B		00 - 7F	DRUM CHORUS LEVEL	0-127	64

<MODEL ID = 42H> MULTI MODE

[SYSTEM PARAMETERS]

Address(H)	SIZE(H)	Data(H)	Parameter	Description	Default Value (H)
40 00 00	00 00 04	0018 - 07E8	MASTER TUNE	-100.0 - +100.0 [cent]	00 04 00 00
40 00 01#				Use nibblized data.	
40 00 02#					
40 00 03#					
40 00 04	00 00 01	00 - 7F	MASTER VOLUME	0 - 127	7F
40 00 05	00 00 01	28 - 58	MASTER KEY-SHIFT	-24 - +24 semitones	40
40 00 06	00 00 01	01 - 7F	MASTER PAN		40
40 00 7F	00 00 01	00	GS RESET	All internal parameters are reset to the GS default setting. Ignored when "GS reset Rx:OFF".	

For example:

If you set the master tune 100 cents higher, following messages should be sent.

F0 41 10 42 12 40 00 00 00 07 0E 08 sum F7

If you set the master volume at 100 (decimal), following messages should be sent.

F0 41 10 42 12 40 00 04 64 sum F7

[PATCH PARAMETERS]

*n...block number (0 - F),Part 1(default MIDlch = 1)n=1

```

:
:
Part 9(default MIDlch = 9)n=9
Part 10(default MIDlch = 10)n=0
Part 11(default MIDlch = 11)n=A
:
:
Part 16(default MIDlch = 16)n=F

```

*x...MIDI channel number (0 - F).

Address(H)	SIZE(H)	Data(H)	Parameter	Description	Default Value (H)
40 01 00	00 00 10	20 - 7F	PATCH NAME	16 ASCII Characters	--
40 01 0F#					
40 01 10	00 00 10	00 - 1C	VOICE RESERVE	Part 10(Drums)	02
40 01 11#				Part 1	06
40 01 12#				Part 2	02
40 01 13#				Part 3	02
40 01 14#				Part 4	02
40 01 15#				Part 5	02
40 01 16#				Part 6	02
40 01 17#				Part 7	02
40 01 18#				Part 8	02
40 01 19#				Part 9	02
40 01 1A#				Part 11	00
40 01 : #				:	
40 01 1F#				Part 16	00

The sum total of voice reserves should not exceed the maximum polyphony of the generator.

For example, 1CH is the maximum value for a 28 voice sound generator.

40 01 30	00 00 01	00 - 07	REVERB MACRO	00: Room 1 01: Room 2 02: Room 3 03: Hall 1 04: Hall 2 05: Plate 06: Delay 07: Panning Delay	04
40 01 31	00 00 01	00 - 07	REVERB CHARACTER		04
40 01 32	00 00 01	00 - 07	REVERB PRE-LPF		00
40 01 33	00 00 01	00 - 7F	REVERB LEVEL		40
40 01 34	00 00 01	00 - 7F	REVERB TIME		40
40 01 35	00 00 01	00 - 7F	REVERB DELAY FEEDBACK		00
40 01 36	00 00 01	00 - 7F	REVERB SEND LEVEL TO CHORUS		00

Address(H)	SIZE(H)	Data(H)	Parameter	Description	Default Value (H)
40 01 38	00 00 01	00 - 07	CHORUS MACRO	00: Chorus 1 01: Chorus 2 02: Chorus 3 03: Chorus 4 04: Feedback Chorus 05: Flanger 06: Short Delay 07: Short Delay(FB)	02
40 01 39	00 00 01	00 - 07	CHORUS PRE-LPF		00
40 01 3A	00 00 01	00 - 7F	CHORUS LEVEL		40
40 01 3B	00 00 01	00 - 7F	CHORUS FEEDBACK		08
40 01 3C	00 00 01	00 - 7F	CHORUS DELAY		50
40 01 3D	00 00 01	00 - 7F	CHORUS RATE		03
40 01 3E	00 00 01	00 - 7F	CHORUS DEPTH		13
40 01 3F	00 00 01	00 - 7F	CHORUS SEND LEVEL TO REVERB		00
40 1n 00	00 00 02	00 - 7F	TONE NUMBER	CC#00 VALUE	00
40 1n 01#	00 - 7F			P.C. VALUE	00
Ignored when "PRG RX: Off".					
40 1n 02	00 00 01	00 - 10	Rx. CHANNEL	1 - 16.OFF	same as the Part#
40 1n 03	00 00 01	00 - 01	Rx. PITCH BEND	OFF / ON	01
40 1n 04	00 00 01	00 - 01	Rx. CH PRESSURE(CA#)	OFF / ON	01
40 1n 05	00 00 01	00 - 01	Rx. PROGRAM CHANGE	OFF / ON	01
40 1n 06	00 00 01	00 - 01	Rx. CONTROL CHANGE	OFF / ON	01
40 1n 07	00 00 01	00 - 01	Rx. POLY PRESSURE(PA#)	OFF / ON	01
40 1n 08	00 00 01	00 - 01	Rx. NOTE MESSAGE	OFF / ON	01
Ignored when "MUTE Lock: On".					
40 1n 09	00 00 01	00 - 01	Rx. RPN	OFF / ON	01
40 1n 0A	00 00 01	00 - 01	Rx. NRPN	OFF / ON	01
40 1n 0B	00 00 01	00 - 01	Rx. MODULATION	OFF / ON	01
40 1n 0C	00 00 01	00 - 01	Rx. VOLUME	OFF / ON	01
40 1n 0D	00 00 01	00 - 01	Rx. PANPOT	OFF / ON	01
40 1n 0E	00 00 01	00 - 01	Rx. EXPRESSION	OFF / ON	01
40 1n 0F	00 00 01	00 - 01	Rx. HOLD1	OFF / ON	01
40 1n 10	00 00 01	00 - 01	Rx. PORTAMENTO	OFF / ON	01
40 1n 11	00 00 01	00 - 01	Rx. SOSTENUTO	OFF / ON	01
40 1n 12	00 00 01	00 - 01	Rx. SOFT	OFF / ON	01
The OFF/ON setting of the receiving switch(40 1n 03 - 40 1n 12) must be executed while the unit is not sounding.					
40 1n 13	00 00 01	00 - 01	MONO/POLY MODE	Mono / Poly (=Bx 7E 01 / Bx 7F 00)	01
40 1n 14	00 00 01	00 - 02	ASSIGN MODE	0 = SINGLE 1 = LIMITED-MULTI 2 = FULL-MULTI	00 at n=0 01 at n≠0
40 1n 15	00 00 01	00 - 02	USE FOR RHYTHM PART	0 = OFF 1 = MAP1 2 = MAP2	00 at n≠0 01 at n=0
40 1n 16	00 00 01	28 - 58	PITCH KEY SHIFT	-24 - +24 [semitone]	40
40 1n 17	00 00 02	08 - F8	PITCH OFFSET FINE	-12.0 - +12.0 [Hz]	08 00
40 1n 18#			Use nibblized data.		
40 1n 19	00 00 01	00 - 7F	PART LEVEL	0 - 127 (=Bx 07 vv)	64
40 1n 1A	00 00 01	00 - 7F	VELOCITY SENSE DEPTH	0 - 127	40
40 1n 1B	00 00 01	00 - 7F	VELOCITY SENSE OFFSET	0 - 127	40
40 1n 1C	00 00 01	00 - 7F	PART PANPOT	Random.-63(LEFT) - +63(RIGHT) (=Bx 0A vv, except random)	40
40 1n 1D	00 00 01	00 - 7F	KEY RANGE LOW	C-1 - G9	00
40 1n 1E	00 00 01	00 - 7F	KEY RANGE HIGH	C-1 - G9	7F
40 1n 1F	00 00 01	00 - 5F	CC1 CONTROLLER NUMBER	0 - 95	10
40 1n 20	00 00 01	00 - 5F	CC2 CONTROLLER NUMBER	0 - 95	11
40 1n 21	00 00 01	00 - 7F	CHORUS SEND LEVEL	0 - 127 (=Bx 5D vv)	00
40 1n 22	00 00 01	00 - 7F	REVERB SEND LEVEL	0 - 127 (=Bx 5B vv)	28

40 1n 30	00 00 01	0E - 72	TONE MODIFY 1 Vibrato rate	-50 - +50 (=Bx 63 01 62 08 06 vv)	40
40 1n 31	00 00 01	0E - 72	TONE MODIFY 2 Vibrato depth	-50 - +50 (=Bx 63 01 62 09 06 vv)	40
Address(H)	SIZE(H)	Data(H)	Parameter	Description	Default Value (H)
40 1n 32	00 00 01	0E - 72	TONE MODIFY 3 TVF cutoff freq.	-50 - +50 (=Bx 63 01 62 20 06 vv)	40
40 1n 33	00 00 01	0E - 72	TONE MODIFY 4 TVF resonance	-50 - +50 (=Bx 63 01 62 21 06 vv)	40
40 1n 34	00 00 01	0E - 72	TONE MODIFY 5 TVF&TVA Env.attack	-50 - +50 (=Bx 63 01 62 63 06 vv)	40
40 1n 35	00 00 01	0E - 72	TONE MODIFY 6 TVF&TVA Env.decay	-50 - +50 (=Bx 63 01 62 64 06 vv)	40
40 1n 36	00 00 01	0E - 72	TONE MODIFY 7 TVF&TVA Env.release	-50 - +50 (=Bx 63 01 62 66 06 vv)	40
40 1n 37	00 00 01	0E - 72	TONE MODIFY 8 Vibrato delay	-50 - +50 (=Bx 63 01 62 0A 06 vv)	40
40 1n 40	00 00 0C	00 - 7F	SCALE TUNING C	-64 - +63 [cent]	40
40 1n 41#		00 - 7F	SCALE TUNING C#	-64 - +63 [cent]	40
40 1n 42#		00 - 7F	SCALE TUNING D	-64 - +63 [cent]	40
40 1n 43#		00 - 7F	SCALE TUNING D#	-64 - +63 [cent]	40
40 1n 44#		00 - 7F	SCALE TUNING E	-64 - +63 [cent]	40
40 1n 45#		00 - 7F	SCALE TUNING F	-64 - +63 [cent]	40
40 1n 46#		00 - 7F	SCALE TUNING F#	-64 - +63 [cent]	40
40 1n 47#		00 - 7F	SCALE TUNING G	-64 - +63 [cent]	40
40 1n 48#		00 - 7F	SCALE TUNING G#	-64 - +63 [cent]	40
40 1n 49#		00 - 7F	SCALE TUNING A	-64 - +63 [cent]	40
40 1n 4A#		00 - 7F	SCALE TUNING A#	-64 - +63 [cent]	40
40 1n 4B#		00 - 7F	SCALE TUNING B	-64 - +63 [cent]	40
40 2n 00	00 00 01	28 - 58	MOD PITCH CONTROL	-24 - +24 [semitone]	40
40 2n 01	00 00 01	00 - 7F	MOD TVF CUTOFF CONTROL	-9600 - +9600 [cent]	40
40 2n 02	00 00 01	00 - 7F	MOD AMPLITUDE CONTROL	-100.0 - +100.0 [%]	40
40 2n 03	00 00 01	00 - 7F	MOD LFO1 RATE CONTROL	-10.0 - +10.0 [Hz]	40
40 2n 04	00 00 01	00 - 7F	MOD LFO1 PITCH DEPTH	0 - 600 [cent]	0A
40 2n 05	00 00 01	00 - 7F	MOD LFO1 TVF DEPTH	0 - 2400 [cent]	00
40 2n 06	00 00 01	00 - 7F	MOD LFO1 TVA DEPTH	0 - 100.0 [%]	00
40 2n 07	00 00 01	00 - 7F	MOD LFO2 RATE CONTROL	-10.0 - +10.0 [Hz]	40
40 2n 08	00 00 01	00 - 7F	MOD LFO2 PITCH DEPTH	0 - 600 [cent]	00
40 2n 09	00 00 01	00 - 7F	MOD LFO2 TVF DEPTH	0 - 2400 [cent]	00
40 2n 0A	00 00 01	00 - 7F	MOD LFO2 TVA DEPTH	0 - 100.0 [%]	00
40 2n 10	00 00 01	28 - 58	BEND PITCH CONTROL	-24 - +24 [semitone]	42
40 2n 11	00 00 01	00 - 7F	BEND TVF CUTOFF CONTROL	-9600 - +9600 [cent]	40
40 2n 12	00 00 01	00 - 7F	BEND AMPLITUDE CONTROL	-100.0 - +100.0 [%]	40
40 2n 13	00 00 01	00 - 7F	BEND LFO1 RATE CONTROL	-10.0 - +10.0 [Hz]	40
40 2n 14	00 00 01	00 - 7F	BEND LFO1 PITCH DEPTH	0 - 600 [cent]	00
40 2n 15	00 00 01	00 - 7F	BEND LFO1 TVF DEPTH	0 - 2400 [cent]	00
40 2n 16	00 00 01	00 - 7F	BEND LFO1 TVA DEPTH	0 - 100.0 [%]	00
40 2n 17	00 00 01	00 - 7F	BEND LFO2 RATE CONTROL	-10.0 - +10.0 [Hz]	40
40 2n 18	00 00 01	00 - 7F	BEND LFO2 PITCH DEPTH	0 - 600 [cent]	00
40 2n 19	00 00 01	00 - 7F	BEND LFO2 TVF DEPTH	0 - 2400 [cent]	00
40 2n 1A	00 00 01	00 - 7F	BEND LFO2 TVA DEPTH	0 - 100.0 [%]	00
40 2n 20	00 00 01	28 - 58	CAI PITCH CONTROL	-24 - +24 [semitone]	40
40 2n 21	00 00 01	00 - 7F	CAI TVF CUTOFF CONTROL	-9600 - +9600 [cent]	40
40 2n 22	00 00 01	00 - 7F	CAI AMPLITUDE CONTROL	-100.0 - +100.0 [%]	40
40 2n 23	00 00 01	00 - 7F	CAI LFO1 RATE CONTROL	-10.0 - +10.0 [Hz]	40
40 2n 24	00 00 01	00 - 7F	CAI LFO1 PITCH DEPTH	0 - 600 [cent]	00
40 2n 25	00 00 01	00 - 7F	CAI LFO1 TVF DEPTH	0 - 2400 [cent]	00
40 2n 26	00 00 01	00 - 7F	CAI LFO1 TVA DEPTH	0 - 100.0 [%]	00
40 2n 27	00 00 01	00 - 7F	CAI LFO2 RATE CONTROL	-10.0 - +10.0 [Hz]	40
40 2n 28	00 00 01	00 - 7F	CAI LFO2 PITCH DEPTH	0 - 600 [cent]	00
40 2n 29	00 00 01	00 - 7F	CAI LFO2 TVF DEPTH	0 - 2400 [cent]	00
40 2n 2A	00 00 01	00 - 7F	CAI LFO2 TVA DEPTH	0 - 100.0 [%]	00
40 2n 30	00 00 01	28 - 58	PAI PITCH CONTROL	-24 - +24 [semitone]	40
40 2n 31	00 00 01	00 - 7F	PAI TVF CUTOFF CONTROL	-9600 - +9600 [cent]	40
40 2n 32	00 00 01	00 - 7F	PAI AMPLITUDE CONTROL	-100.0 - +100.0 [%]	40
40 2n 33	00 00 01	00 - 7F	PAI LFO1 RATE CONTROL	-10.0 - +10.0 [Hz]	40
40 2n 34	00 00 01	00 - 7F	PAI LFO1 PITCH DEPTH	0 - 600 [cent]	00
40 2n 35	00 00 01	00 - 7F	PAI LFO1 TVF DEPTH	0 - 2400 [cent]	00
40 2n 36	00 00 01	00 - 7F	PAI LFO1 TVA DEPTH	0 - 100.0 [%]	00
40 2n 37	00 00 01	00 - 7F	PAI LFO2 RATE CONTROL	-10.0 - +10.0 [Hz]	40
40 2n 38	00 00 01	00 - 7F	PAI LFO2 PITCH DEPTH	0 - 600 [cent]	00
40 2n 39	00 00 01	00 - 7F	PAI LFO2 TVF DEPTH	0 - 2400 [cent]	00
40 2n 3A	00 00 01	00 - 7F	PAI LFO2 TVA DEPTH	0 - 100.0 [%]	00

Address(H)	SIZE(H)	Data(H)	Parameter	Description	Default Value (H)
40 2n 40	00 00 01	28 - 58	CC1 PITCH CONTROL	-24 - +24 [semitone]	40
40 2n 41	00 00 01	00 - 7F	CC1 TVF CUTOFF CONTROL	-9600 - +9600 [cent]	40
40 2n 42	00 00 01	00 - 7F	CC1 AMPLITUDE CONTROL	-100.0 - +100.0 [%]	40
40 2n 43	00 00 01	00 - 7F	CC1 LFO1 RATE CONTROL	-10.0 - +10.0 [Hz]	40
40 2n 44	00 00 01	00 - 7F	CC1 LFO1 PITCH DEPTH	0 - 600 [cent]	00
40 2n 45	00 00 01	00 - 7F	CC1 LFO1 TVF DEPTH	0 - 2400 [cent]	00
40 2n 46	00 00 01	00 - 7F	CC1 LFO1 TVA DEPTH	0 - 100.0 [%]	00
40 2n 47	00 00 01	00 - 7F	CC1 LFO2 RATE CONTROL	-10.0 - +10.0 [Hz]	40
40 2n 48	00 00 01	00 - 7F	CC1 LFO2 PITCH DEPTH	0 - 600 [cent]	00
40 2n 49	00 00 01	00 - 7F	CC1 LFO2 TVF DEPTH	0 - 2400 [cent]	00
40 2n 4A	00 00 01	00 - 7F	CC1 LFO2 TVA DEPTH	0 - 100.0 [%]	00
40 2n 50	00 00 01	28 - 58	CC2 PITCH CONTROL	-24 - +24 [semitone]	40
40 2n 51	00 00 01	00 - 7F	CC2 TVF CUTOFF CONTROL	-9600 - +9600 [cent]	40
40 2n 52	00 00 01	00 - 7F	CC2 AMPLITUDE CONTROL	-100.0 - +100.0 [%]	40
40 2n 53	00 00 01	00 - 7F	CC2 LFO1 RATE CONTROL	-10.0 - +10.0 [Hz]	40
40 2n 54	00 00 01	00 - 7F	CC2 LFO1 PITCH DEPTH	0 - 600 [cent]	00
40 2n 55	00 00 01	00 - 7F	CC2 LFO1 TVF DEPTH	0 - 2400 [cent]	00
40 2n 56	00 00 01	00 - 7F	CC2 LFO1 TVA DEPTH	0 - 100.0 [%]	00
40 2n 57	00 00 01	00 - 7F	CC2 LFO2 RATE CONTROL	-10.0 - +10.0 [Hz]	40
40 2n 58	00 00 01	00 - 7F	CC2 LFO2 PITCH DEPTH	0 - 600 [cent]	00
40 2n 59	00 00 01	00 - 7F	CC2 LFO2 TVF DEPTH	0 - 2400 [cent]	00
40 2n 5A	00 00 01	00 - 7F	CC2 LFO2 TVA DEPTH	0 - 100.0 [%]	00

As the LFO is used for creating the internal sounds. In some cases, changing the parameters of LFO1 and LFO2 may not affect the sound.

[INFORMATION]-----RQ1 ONLY -----

Address(H)	SIZE(H)	Data(H)	Parameter
40 30 00	00 00 20	20 - 7F	SYSTEM INFORMATION
:	#		
:	#		
:	#		
40 30 1F#			

[DRUM SETUP PARAMETER]

*m:Map number (0 = MAP1, 1 = MAP2)

*rr:drums part note number (00 - 7F)

Address(H)	SIZE(H)	Data(H)	Parameter	Description
41 m0 00	00 00 0C	20 - 7F	DRUMS MAP NAME	ASCII Character
:	#			
41 m0 0B#				
41 m1 rr	00 00 01	00 - 7F	PLAY NOTE NUMBER	Pitch course
41 m2 rr	00 00 01	00 - 7F	LEVEL	TVA level (=Bx 63 1A 62 rr 06 vv)
41 m3 rr	00 00 01	00 - 7F	ASSIGN GROUP NUMBER	Non, 1 - 127
41 m4 rr	00 00 01	00 - 7F	PANPOT	Random, -63(LEFT) - +63(RIGHT) (=Bx 63 1C 62 rr 06 vv)
41 m5 rr	00 00 01	00 - 7F	REVERB DEPTH	0.0 - 1.0 Multiplicand of the part reverb depth (=Bx 63 1D 62 rr 06 vv)
41 m6 rr	00 00 01	00 - 7F	CHORUS DEPTH	0.0 - 1.0 Multiplicand of the part chorus depth (=Bx 63 1E 62 rr 06 vv)
41 m7 rr	00 00 01	00 - 01	Rx. NOTE OFF	OFF / ON
41 m8 rr	00 00 01	00 - 01	Rx. NOTE ON	OFF / ON

When you change drum sets, all value of the DRUM SETUP PARAMETER will be initialized.

[Bulk Dump]

1-packet = 128 byte(MIDI)

--- ALL (8 + 64 + (112 * 16) = 0x748 byte)

--- 0x748 * 2(nibblize) = 1D 10 (MIDI)

Address(H)	SIZE(H)	Data(H)	Parameter	Description
48 00 00	00 1D 10			
: #			30 packets	
48 1D 0F#				

--- SYSTEM PARAMETER (8 = 0x08 byte)

--- 0x08 * 2(nibblize) = 00 10 (MIDI)

Address(H)	SIZE(H)	Data(H)	Parameter	Description
48 00 00	00 00 10			
: #			1 packet	
48 00 0F#				

--- PATCH COMMON (64 = 0x40 byte)

--- 0x40 * 2(nibblize) = 01 00 (MIDI)

Address(H)	SIZE(H)	Data(H)	Parameter	Description
48 00 10	00 01 00			
: #			1 packet	
48 01 0F#				

--- PATCH PART (112 = 0x70 byte)

--- 0x70 * 2(nibblize) = 01 60 (MIDI)

Address(H)	SIZE(H)	Data(H)	Parameter	Description
48 01 10	00 01 60			
: #		block 0	2 packet	
48 02 6F#				
48 02 70	00 01 60			
: #		block 1	2 packet	
48 04 4F#				
48 04 50	00 01 60			
: #		block 2	2 packet	
48 06 2F#				
48 06 30	00 01 60			
: #		block 3	2 packet	
48 08 0F#				
48 08 10	00 01 60			
: #		block 4	2 packet	
48 09 6F#				
48 09 70	00 01 60			
: #		block 5	2 packet	
48 0B 4F#				
48 0B 50	00 01 60			
: #		block 6	2 packet	
48 0D 2F#				
48 0D 30	00 01 60			
: #		block 7	2 packet	
48 0F 0F#				
48 0F 10	00 01 60			
: #		block 8	2 packet	
48 10 6F#				
48 10 70	00 01 60			
: #		block 9	2 packet	
48 12 4F#				
48 12 50	00 01 60			
: #		block A	2 packet	
48 14 2F#				

48 14 30 00 01 60
 : # block B 2 packet
48 16 0F#

48 16 10 00 01 60
 : # block C 2 packet
48 17 6F#

48 17 70 00 01 60
 : # block D 2 packet
48 19 4F#

48 19 50 00 01 60
 : # block E 2 packet
48 1B 2F#

48 1B 30 00 01 60
 : # block F 2 packet
48 1D 0F#

----- DRUM MAP PARAMETER(128 = 80h)

----- 0x80 * 2(nibblize) = 00 02 00 (MIDI)

Address(H)	SIZE(H)	Description	
49 m0 00	00 02 00		
:		PLAY KEY NUMBER	2 packet
49 m1 7F			
49 m2 00	00 02 00		
:		LEVEL	2 packet
49 m3 7F			
49 m4 00	00 02 00		
:		ASSIGN GROUP NUMBER	2 packet
49 m5 7F			
49 m6 00	00 02 00		
:		PANPOT	2 packet
49 m7 7F			
49 m8 00	00 02 00		
:		REVERB DEPTH	2 packet
49 m9 7F			
49 mA 00	00 02 00		
:		CHORUS DEPTH	2 packet
49 mB 7F			
49 mC 00	00 02 00		
:		Rx. NOTE ON/OFF	2 packet
49 mD 7F			
49 mE 00	00 00 18		
:		DRUM MAP NAME	1 packet
49 mE 17			

m: map number (0 - 1)

MIDI Implementation Chart

Function...		Transmitted	Recongized	Remarks
Basic Channel	Default Changed	1 1-16	1 1-16	SINGLE mode
Mode	Default Messages Altered	x x *****	Mode 1 Mode 1- 4 (M=1)	SINGLE mode *2
Note Number	True voice	0 ***** *3	0-127 0-127	
Velocity	Note ON Note OFF	x x	o x	
After Touch	Key's Ch's	x x	o *1 o *1	
Pitch Bend		x	o *1	
Control Change	0,32 1 5 6,38 7 10 11 64 65 66 67 91 93 98,99 100,101 120 121	x x x x x x x x x x x x x x x x x	o (MSB only) o *1 o *1 o *1 o *1 o *1 o *1 o *1 o *1 o *1 o (Reverb) *1 o (Chorus) *1 o *1 o *1 o o	Bank Select Modulation Portamento Time Data Entry Volume Panpot Expression Hold 1 Portamento Sostenuto Soft Effect 1 Depth Effect 3 Depth NRPN LSB, MSB RPN LSB, MSB All Sound Off Reset All Controller
Prog Change	True #	o ***** *4	o *1 0-127	Program Number 1-128
System Exclusive		o	o	
System Common	Song Pos Song Sel Tune	x x x	x x x	
System Real Time	Clock Commands	x x	x x	
Aux Messages	Local ON/OFF All Notes OFF Active Sense Reset	x x o x	x o (123-125) o x	
Notes	*1 o x is selectable. *2 Recognize as M=1 even if M≠1. *3 Only SINGLE DRUM mode. *4 Only SINGLE TONE/DRUM mode.			

Mode 1 : OMNI ON , POLY
Mode 3 : OMNI OFF, POLY

Mode 2 : OMNI ON, MONO
Mode 4 : OMNI OFF, MONO

O : Yes
X : No

■ How to read a MIDI Implementation Chart

○ : MIDI messages that can be transmitted or received.

× : MIDI messages that cannot be transmitted or received.

● Basic Channel

The MIDI channel for transmitting (receiving) MIDI messages can be specified over this range. The MIDI channel setting is remembered even when the power is turned off.

● Mode

Most recent keyboard use mode 3 (omni off, poly).

Reception : MIDI messages are received only on the specified channels, and played polyphonically.

Transmission : All MIDI data is transmitted on the specified MIDI channel.

* "Mode" refers to MIDI Mode messages.

● Note Number

This is the range of note numbers that can be transmitted (received). Note number 60 is middle C (C4).

● Velocity

This is the range over which velocity can be transmitted (received) by Note On and Note Off messages.

● Aftertouch

Key's : Polyphonic Aftertouch

Ch's : Channel Aftertouch

● Pitch Bender

Set the receiving range of Pitch Bend messages by using Bend Range of each part.

● Control Change

This indicates the control numbers that can be transmitted (received), and what they will control. For details, refer to the MIDI implementation.

● Program Change

The program change numbers in the chart indicate the actual data. (This is one less than the instrument program numbers.)

● Exclusive

Exclusive message reception can be turned on/off by the exclusive message receiving switch.

● Common, Real time

These MIDI messages are used to synchronize sequencers and rhythm machines.

The Doctor Synth does not use these messages.

● Aux messages

These messages are mainly used to keep a MIDI system running correctly.

Active sensing transmission can be turned on/off.

■ Specifications

DS-330: Dr.Synth

Parts:	16 Parts
Maximum Polyphony:	28 voices
Effects:	Reverb/Delay, Chorus
Display:	66 × 26mmLCD
Connectors:	MIDI Connectors (In, Out, Thru) Output Jacks L (MONO)/R (1/4 inch phone type) Headphone Jack (Stereo mini type) AC Adaptor Jack (AC 12V)
Power Supply:	AC12V: AC Adaptor BRA Series
Current Draw:	500mA
Dimensions:	215 (W) × 165 (D) × 57 (H) mm 8-7/16" (W) × 6-1/2" (D) × 2-1/4" (H) inches
Weight:	650g/1 lb 7 oz
Accessories:	AC Adaptor BRA Series Owner's Manual

* 0dBm = 0.775Vrms

* In the interest of product improvement, the specifications of this unit are subject to change without prior notice.

Index

AC Adaptor	11
Attack Time	38
Bend Range	34
Chorus	21, 33 (SINGLE Mode)
Chorus	50, 55, 58 (MULTI Mode)
Contrast	42, 62
Correspondence with Program Change Messages	80
Cutoff Frequency	37
Data	75
Decay Time	38
Device ID Number	41, 61
Drum Mode	27
Drum Pad Table	91
Drum Sets	27 (SINGLE Mode)
Drum Sets	48 (MULTI Mode)
Drum Set Table	90
Dual	22
Error Messages	82
General MIDI System	76
GS Format	76
GS Initialize	62
GS Reset Receive Switch	60
FAT	20, 31
Headphones	11
Hold	37
If You Think There Might Be a Problem	81
Initialize	44
Initialization	83
Key Shift	40 (SINGLE Mode)
Key Shift	59 (MULTI Mode)
Lower Tone	25
Lower Tone Level	26
Map	43
Master Level	56
Master Tune	40 (SINGLE Mode)
Master Tune	60 (MULTI Mode)
Maximum Polyphony	76
MIDI Applications	63
MIDI Channel	65
MIDI Connections	10, 64
MIDI Implementation	94
MIDI Implementation Chart	106
MIDI Receive Channel	40
MIDI Volume Receive Switch	41
Modulation Depth	34
M/P Mode	36
MULTI Mode	7
Multi Mode/Edit	53
Multi Mode/Play	45
Mute Lock	60
OMNI	40, 65
Output Connections	10
Parameter Table	84

Part	46
Part Key Shift	55
Part Level	54
Part MIDI Channel	55
Part Mute	51
Part Pan	54
Portamento	37
Program Change Receive Switch	40 (SINGLE Mode)
Program Change Receive Switch	60 (MULTI Mode)
Receiving Data (Bulk Load)	71
Registering Tones	17
Release Time	38
Resonance	37
Reverb	21, 32 (SINGLE Mode)
Reverb	50, 55, 57 (MULTI Mode)
ROM Play	13
Roland Exclusive Messages	92
Sending Data (Bulk Dump)	68
SINGLE Mode	7
Single Mode/Edit	29
Single Mode/Play	19
Specifications	108
Split	22
Split Point	25
Standard GS Features	76
Sub Tone	26
Sub Tone Level	26
Switching Banks	16
Switching Between Drum Sets	28
Switching Between Single and Multi Mode	7
Switching Between Variations	18
Switching Numbers	17
Switching Tones	16 (SINGLE Mode)
Switching Tones for Each part	47 (MULTI Mode)
Tone level	31
Tones	15
Tone Table	87
Tone Variations	77
Velocity Sens Depth	35
Velocity Sens Offset	35
Vibrato	36
Volume	14

MEMO

MEMO

MEMO

Information

When you need repair service, call your local Roland Service Station or the authorized Roland distributor in your country as shown below.

U. S. A.

Roland Corporation US
7200 Dominion Circle
Los Angeles, CA.
90040-3647, U. S. A.
☎ (213)685 - 5141

CANADA

Roland Canada Music Ltd.
(Head Office)
5480 Parkwood
Richmond B. C., V6V 2M4
CANADA
☎ (604)270 - 6626

Roland Canada Music Ltd.
9425 Transcanadienne
Service Rd. N., St Laurent,
Quebec H4S 1V3,
CANADA
☎ (514)335 - 2009

Roland Canada Music Ltd.
346 Watline Avenue,
Mississauga, Ontario L4Z
1X2, CANADA
☎ (416)890 - 6488

AUSTRALIA

Roland Corporation
(Australia) Pty. Ltd.
(Head Office)
38 Campbell Avenue
Dee Why West. NSW 2099
AUSTRALIA
☎ (02)982 - 8266

Roland Corporation
(Australia) Pty. Ltd.
(Melbourne Office)
50 Garden Street
South Yarra, Victoria 3141
AUSTRALIA
☎ (03)241 - 1254

UNITED KINGDOM

Roland(U.K.) Ltd.
Rye Close
Ancells Business Park
Fleet, Hampshire GU13
8UY, UNITED KINGDOM
☎ 0252 - 816181

Roland(U.K.) Ltd.,
Swansea Office
Atlantic Close, Swansea
Enterprise Park, Swansea,
West Glamorgan SA79FJ,
UNITED KINGDOM
☎ (0792)700 - 139

ITALY

Roland Italy S. p. A.
Viale delle Industrie 8
20020 ARESE MILANO
ITALY
☎ 02 - 93581311

SPAIN

Roland Electronics
de España, S. A.
Calle Bolivia 239
08020 Barcelona, SPAIN
☎ 93 - 308 - 1000

GERMANY

Roland Elektronische
Musikinstrumente
Handelsgesellschaft mbH.
Oststrasse 96, 2000
Norderstedt, GERMANY
☎ 040/52 60 090

FRANCE

Musikengro
102 Avenue Jean-Jaures
69007 Lyon Cedex 07
FRANCE
☎ (7)858 - 54 60

Musikengro (Paris Office)
Centre Region Parisienne
41 rue Charles-Fourier,
94400 Vitry s/Seine
FRANCE
☎ (1)4680 86 62

BELGIUM/ HOLLAND/ LUXEMBOURG

Roland Benelux N. V.
Houtstraat 1
B-2260 Oevel-Westerlo
BELGIUM
☎ (0032)14 - 575811

DENMARK

Roland Scandinavia A/S
Langebrogade 6
Box 1937
DK-1023 Copenhagen K.
DENMARK
☎ 31 - 95 31 11

SWEDEN

Roland Scandinavia A/S
DanvikCenter 28 A, 2 tr.
S-131 30 Nacka
SWEDEN
☎ 08 - 702 00 20

NORWAY

Roland Scandinavia
Avd. Norge
Lilleakerveien 2
Postboks 95 Lilleaker
N-0216 Oslo 2
NORWAY
☎ 02 - 73 00 74

FINLAND

Fazer Musik Inc.
Länsituulentie
POB 169
SF-02101 Espoo
FINLAND
☎ 0 - 43 50 11

NEW ZEALAND

Roland Corporation
(NZ) Ltd.
97 Mt. Eden Road, Mt.
Eden, Auckland 3,
NEW ZEALAND
☎ (09)3098 - 715

SWITZERLAND

Musitronic AG
Gerberstrasse 5, CH-4410
Liestal, SWITZERLAND
☎ 061/921 16 15

Roland CK (Switzerland)
AG
Postfach/Hauptstrasse 21
CH-4456 Tenniken
SWITZERLAND
☎ 061/98 60 55
Repair Service by
Musitronic AG

AUSTRIA

E. Dematte & Co.
Neu-Rum Siemens-
Strasse 4
A-6021 Innsbruck Box 591
AUSTRIA
☎ (0512)63 451

GREECE

V. Dimitriadis & Co. Ltd.
2 Phidiou Str., GR 106 78
Athens, GREECE
☎ 1 - 3620130

PORTUGAL

Casa Caius Instrumentos
Musicais Lda.
Rua de Santa Catarina 131
Porto, PORTUGAL
☎ 02 - 38 44 56

HUNGARY

Intermusica Ltd.
Warehouse Area 'DEPO'
Torokbalint, Budapest
HUNGARY
☎ (1)1868905

ISRAEL

D.J.A. International Ltd.
25 Pinsker St., Tel Aviv
ISRAEL
☎ 972 - 3 - 5283015

CYPRUS

Radex Sound Equipment
Ltd.
17 Panteli Katelari Str.
P.O.Box 2046, Nicosia
CYPRUS
☎ 453426, 466423

TURKEY

Barkat Sanayi ve Ticaret
Siraselviler Cad. 86/6
Taksim Istanbul, TURKEY
☎ 149 93 24

EGYPT

Al Fanny Trading Office
9, Ebn Hagar Askalany
Street, Ard El Golf,
Heliopolis, Cairo, EGYPT
☎ 2917803 - 665918

BRAZIL

Roland Brasil Ltda.
R. Alvarenga 591
CEP-05509 Sao Paulo
BRAZIL
☎ (011)813 - 7967
Repair Service for Roland
and Rhodes products

Oliver do Brasil S.A.
Instrumentos Musicais
Av. Ceci. No.578 Centro
Empresarial Tambore
Barueri SP CEP 06400
BRAZIL
☎ (011)709 - 1267
Repair Service for BOSS
products

MEXICO

Case Veerkamp, s.a. de c.v.
Mesones No. 21
Col. Centro
C.P. 06080 Mexico, D.F.
MEXICO
☎ (5)709 - 3716

La Casa Wagner de
Guadalajara s.a. de c.v.
Av. Corona No. 202 S.J.
C.P. 44100
Guadalajara, Jalisco
MEXICO
☎ (36)13 - 1414

ARGENTINA

Netto S.A.
Venezuela 1433
1095 Buenos Aires
ARGENTINA
☎ 37 - 1632

HONG KONG

Tom Lee Music Co., Ltd.
Service Division
22-32 Pun Shan Street,
Tsuen Wan, New
Territories, HONG KONG
☎ 415 - 0911

KOREA

Cosmos Corporation
Service Station
261 2nd Floor Nak-Won
arcade
Jong-Ro ku, Seoul, KOREA
☎ (02) 742 8844

SINGAPORE

Swee Lee Company
Bras Basah Complex
#03-23 Singapore 0178
SINGAPORE
☎ 3367886

THAILAND

Theera Music Co., Ltd.
330 Vermg Nakorn Kasem,
Soi 2, Bangkok 10100,
THAILAND
☎ 2248821

MALAYSIA

Syarikat Bentley
No.142, Jalan Bukit
Bintang 55100 Kuala
Lumpur, MALAYSIA
☎ 2421288

INDONESIA

PT Galestra Inti
Kompleks Perkantoran
Duta Merlin Blok C/59
Jl. Gajah mada No.3-5
Jakarta 10130
INDONESIA
☎ (021) 354604, 354606

TAIWAN

Siruba Enterprise(Taiwan)
Co., LTD.
Room. 5, 9fl. No. 112
Chung Shan N Road Sec.2
Taipei, TAIWAN, R.O.C.
☎ (02)5364546

SOUTH AFRICA

That Other Music
Shop(PTY) LTD.
256 Bree Street,
Johannesburg 2001
Republic of South Africa
☎ 337 - 6573

Paul Bothner(PTY) LTD.

17 Werdmueller Centre
Claremont 7700
Republic of South Africa
☎ 021 - 64 - 4030

 Roland®

10978

UPC 10978



18961

 **BOSS**
Products of Roland

2605040200 '92-6-C3-11SS (SS)