

BOSS®

DR-5 Dr. Rhythm Section

Owner's Manual

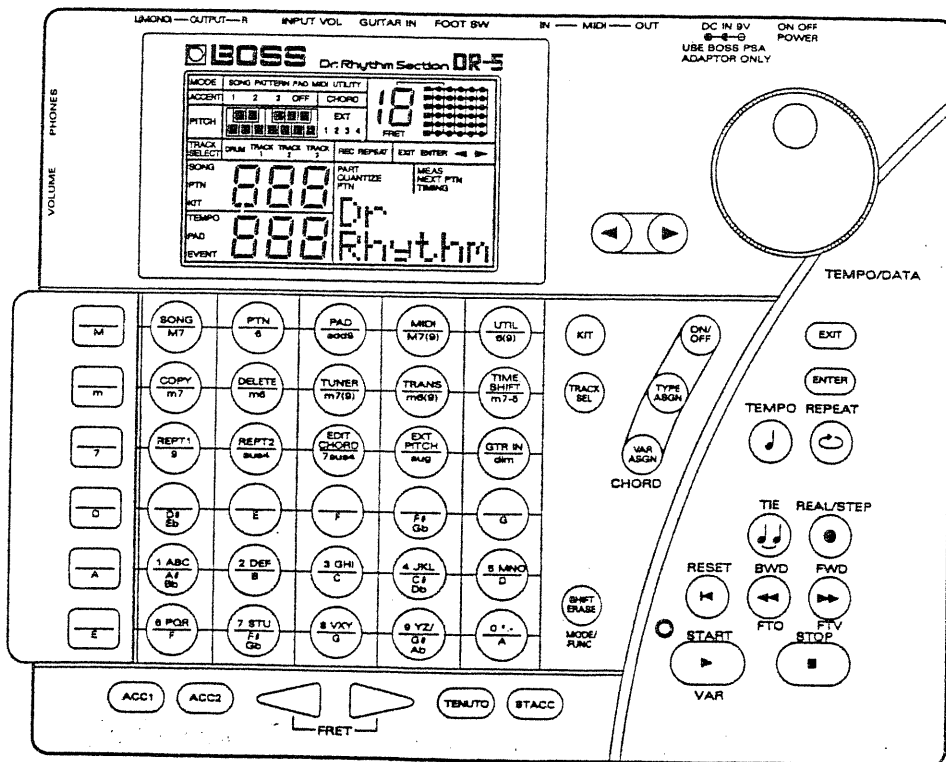

For Nordic Countries

Apparatus containing Lithium batteries

ADVARSEL!

Lithiumbatteri - Eksplosionsfare ved fejlagtig håndtering.
Udskiftning må kun ske med batteri af samme fabrikat og type.
Lever det brugte batteri tilbage til leverandøren.

VARNING!

Explosionsfarligt vid felaktigt batteribyte.
Använd samma batterityp eller en ekvivalent typ som rekommenderas av apparatfabrikanten.
Kassera använt batteri enligt fabrikantens instruktion.

ADVARSEL!

Lithiumbatteri - Eksplosionsfare.
Ved-udskiftning benyttes kun batteri som anbefalt af apparatfabrikanten.
Brug det brugte batteri returneres apparatleverandøren.

VAROITUS!

Paristo voi räjähtää, jos se on virheellisesti asennettu.
Vaihda paristo ainoastaan laitevalmistajan suosittelemaan tyyppiin. Hävittä käytetty paristo valmistajan ohjeiden mukaisesti.

For Germany

Bescheinigung des Herstellers/Importeurs

Hiermit wird bescheinigt, daß der/die/das
BOSS Dr. Rhythm DR-660
.....
(Gerät, Typ, Bezeichnung)

in Übereinstimmung mit den Bestimmungen der
Amtsbl. Vfg 1046/1984
.....
(Amtsblattverfügung)

funk-entstört ist.

Der Deutschen Bundespost wurde das Inverkehrbringen dieses Gerätes angezeigt und die Berechtigung zur Überprüfung der Serie auf Einhaltung der Bestimmungen eingeräumt.

Roland Corporation Osaka/Japan

.....
Name des Herstellers/Importeurs

For the USA

RADIO AND TELEVISION INTERFERENCE

WARNING — This equipment has been verified to comply with the limits for a Class B computing device, pursuant to Subpart J, of Part 15, of FCC rules. Operation with non-certified or non-verified equipment is likely to result in interference to radio and TV reception.

The equipment described in this manual generates and uses radio frequency energy. If it is not installed and used properly, that is, in strict accordance with our instructions, it may cause interference with radio and television reception. This equipment has been tested and found to comply with the limits for a Class B computing device in accordance with the specifications in Subpart J, of Part 15, of FCC Rules. These rules are designed to provide reasonable protection against such interference in a residential installation. However, there is no guarantee that the interference will not occur in a particular installation. If this equipment does cause interference to radio or television reception, which can be determined by turning the equipment on and off, the user is encouraged to try to correct the interference by the following measures:

- Disconnect other devices and their input/output cables one at a time, if the interference stops, it is caused by either the other device or its I/O cable. These devices usually require Roland designated shielded I/O cables. For Roland devices, you can obtain the proper shielded cable from your dealer. For non-Roland devices, contact the manufacturer or dealer for assistance.

If your equipment does cause interference to radio or television reception, you can try to correct the interference by using one or more of the following measures:

- Turn the TV or radio antenna until the interference stops.
- Move the equipment to one side or the other of the TV or radio.
- Move the equipment further away from the TV or radio.
- Plug the equipment into an outlet that is on a different circuit than the TV or radio. (That is, make certain the equipment and the radio or television set are on circuits controlled by different circuit breakers or fuses.)
- Consider installing a rooftop television antenna with coaxial cable lead-in between the antenna and TV. If necessary, you should consult your dealer or an experienced radio/television technician for additional suggestions. You may find helpful the following booklet prepared by the Federal Communications Commission: "How to Identify and Resolve Radio — TV Interference Problems."

This booklet is available from the U.S. Government Printing Office, Washington, D.C., 20402, Stock No. 004-000-00045-4

For Canada

CLASS B

NOTICE

This digital apparatus does not exceed the Class B limits for radio noise emissions set out in the Radio Interference Regulations of the Canadian Department of Communications.

CLASSE B

AVIS

Cet appareil numérique ne dépasse pas les limites de la classe B au niveau des émissions de bruits radioélectriques fixés dans le Règlement des signaux parasites par le ministère canadien des Communications.

DR-5

Dr. Rhythm Section

Preset Pattern List

Pattern Number	Genre	Recommended Tempo	Pattern Number	Genre	Recommended Tempo
000-003	Rock 1	120	100-103	Dance 1	107
004-007	Rock 2	148	104-107	Dance 2	117
008-011	Rock 3	142	108-111	Funk 1	105
012-015	Rock 4	116	112-115	Funk 2	100
016-019	Rock 5	120	116-119	Funk 3	104
020-023	Rock 6	180	120-123	Funk 4	138
024-027	Rock 7	109	124-127	Funk 5	100
028-031	Rock 8	128	128-131	R&B 1	61
032-035	Rock 9	125	132-135	R&B 2	88
036-039	Rock 10	76	136-139	R&B 3	128
040-043	Metal 1	125	140-143	Soul 1	114
044-047	Metal 2	126	144-147	Soul 2	92
048-051	Hard Rock 1	150	148-151	Ballade 1	82
052-055	Hard Rock 2	163	152-155	Ballade 2	77
056-059	Fusion 1	116	156-159	Jazz 1	133
060-063	Fusion 2	92	160-163	Jazz 2	90
064-067	Fusion 3	104	164-167	Jazz 3	100
068-071	Fusion 4	116	168-171	Reggae 1	90
072-075	Country 1	180	172-175	Reggae 2	150
076-079	Country 2	140	176-179	Latin	200
080-083	Electric 1	129	180-183	LatinRock 1	130
084-087	Electric 2	123	184-187	LatinRock 2	109
088-091	House 1	93	188-191	Samba	120
092-095	House 2	120	192-195	Bossanova	65
096-099	House 3	114	196-199	Ambient	61

BOSS

00346345 '93-11-FC2-11D

 **BOSS**[®]

DR-5

Dr. Rhythm Section

Thank you, and congratulations on your choice of the BOSS DR-5 Dr. Rhythm Section.

The DR-5 is an advanced rhythm machine which, unlike conventional units, allows you to create and store bass and backing patterns in addition to rhythm patterns.

Before starting out, please take the time to read through this manual. That way, you will better understand every outstanding feature the unit provides, and can be assured of years of trouble-free service.

Front panel buttons in the text

In this manual, each button on the front panel is represented by the name printed on or above the button.

[Example]

Staccato Key: [STACC]

Start Key: [START]

Cursor Key: [<] [>]

Copyright © 1993 BOSS CORPORATION

All rights reserved. No part of this publication may be reproduced in any form without the permission of BOSS CORPORATION.

Important Notes

Power Supply

- Before connecting this unit to other devices, turn off the power to all units; this will help prevent damage or malfunction.
- Do not use this unit on the same power circuit with any device that will generate line noise; an electric motor or variable lighting system for example.
- The power requirement for this unit is indicated on its nameplate (rear panel). Ensure that the voltage in your installation meets this requirement.
- When disconnecting the AC adaptor from the power outlet, grasp the plug itself; never pull on the cord.
- If the unit is to remain unused for an extended period of time, unplug the power cord.
- The use of an AC adaptor is recommended as the unit's power consumption is relatively high. However, when using batteries, please use the alkaline type.
- When installing or replacing batteries, refer to "How to insert batteries" (page. 1-3).

Placement

- Do not subject the unit to temperature extremes (eg., direct sunlight in an enclosed vehicle). Avoid using or storing the unit in dusty or humid areas, or areas that are subject to high levels of vibration.
- Using the unit near power amplifiers (or other equipment containing large power transformers) may induce hum.
- This device may interfere with radio and television reception. Do not use this device in the vicinity of such receivers.
- Do not expose the unit to temperature extremes or install it near devices that radiate heat. Direct sunlight in an enclosed vehicle can deform or discolor the unit.

Maintenance

- For everyday cleaning wipe the unit with a soft, dry cloth or one that has been slightly dampened with water. To remove stubborn dirt, use a mild, non-abrasive detergent. Afterwards, be sure to wipe the unit thoroughly with a soft, dry cloth.
- Never use benzene, thinners, alcohol or solvents of any kind, to avoid the possibility of discoloration and/or deformation.

Additional Precautions

- Protect the unit from strong impact.
- Do not allow objects or liquids of any kind to penetrate the unit. In the event of such an occurrence, discontinue use immediately. Contact qualified service personnel as soon as possible.
- Never strike or apply strong pressure to the display.
- Should a malfunction occur, or if you suspect there is a problem, discontinue use immediately. Contact qualified service personnel as soon as possible.
- To avoid the risk of electric shock, do not open the unit.

Memory Backup

- This unit contains a battery which powers the unit's memory circuits while the main (AC) power is off. The expected life of this battery is 5 years or more.

However, to avoid the untimely loss of memory data, it is strongly recommended that you change the battery every 5 years.

Please be aware that the actual life of the battery will depend upon the physical environment — especially the temperature — in which the unit is used. When it is time to change the battery, consult with qualified service personnel.

- When the battery becomes weak the following message will appear in the display: "BATT Low!". Please change the battery as soon as possible to avoid the loss of memory data.
- Please be aware that the contents of memory may at times be lost; when the unit is sent for repairs or when by some chance a malfunction has occurred. Important data should be stored in another MIDI device (eg., a sequencer), or written down on paper (if possible).

During repairs, due care is taken to avoid the loss of data. However, in certain cases (such as when circuitry related to memory itself is out of order), we regret that it may not be possible to restore the data.

Changing Batteries

- Avoid using new batteries together with old ones. In addition, avoid mixing different types of batteries (eg., regular carbon and alkaline batteries).
- When replacing batteries, be sure to insert them correctly (to ensure correct polarity).
- Remove the batteries whenever the unit is to remain unused for an extended period of time.

Features of the DR-5

Provides a collection of 256 Instrument sounds, which in addition to the high-quality drum sounds, includes bass, guitar, and other sounds. With this one small unit you can obtain a rhythm section in combination with bass and guitar. And it can accommodate almost any musical genre — whether it be rock, jazz, latin, or rap.

The unit allows for the creation and storage of 200 original patterns (Programmable Patterns) in addition to the 200 Preset Patterns it provides. You can also create 20 new songs using your original patterns.

Since the Key Pads are arranged in the same way as the frets on a guitar, guitar and bass players can input melodies easily.

Since it is equipped with a Specified Pattern Change function, the DR-5 creates fill-ins with ease. If you wish, you can simply use the unit for accompaniment; the same as when using a preset rhythm machine.

If you connect a specialized footswitch, you can obtain pedal control over functions normally controlled by the panel buttons (up to two sets).

A Guitar Amp Simulation circuit is built in. With a guitar connected to the GUITAR IN jack, you can play along with the DR-5.

The External Pitch function allows you to input patterns by playing on a guitar.

The Tuner function comes in handy when tuning your guitar.

The chord input feature allows you to enter even difficult patterns with ease. It can also be used as a chord reference unit.

Since the unit can be operated on batteries (six AA dry-cells), it can be conveniently carried with you and used whenever you need it.

PANEL DESCRIPTIONS

Front Panel

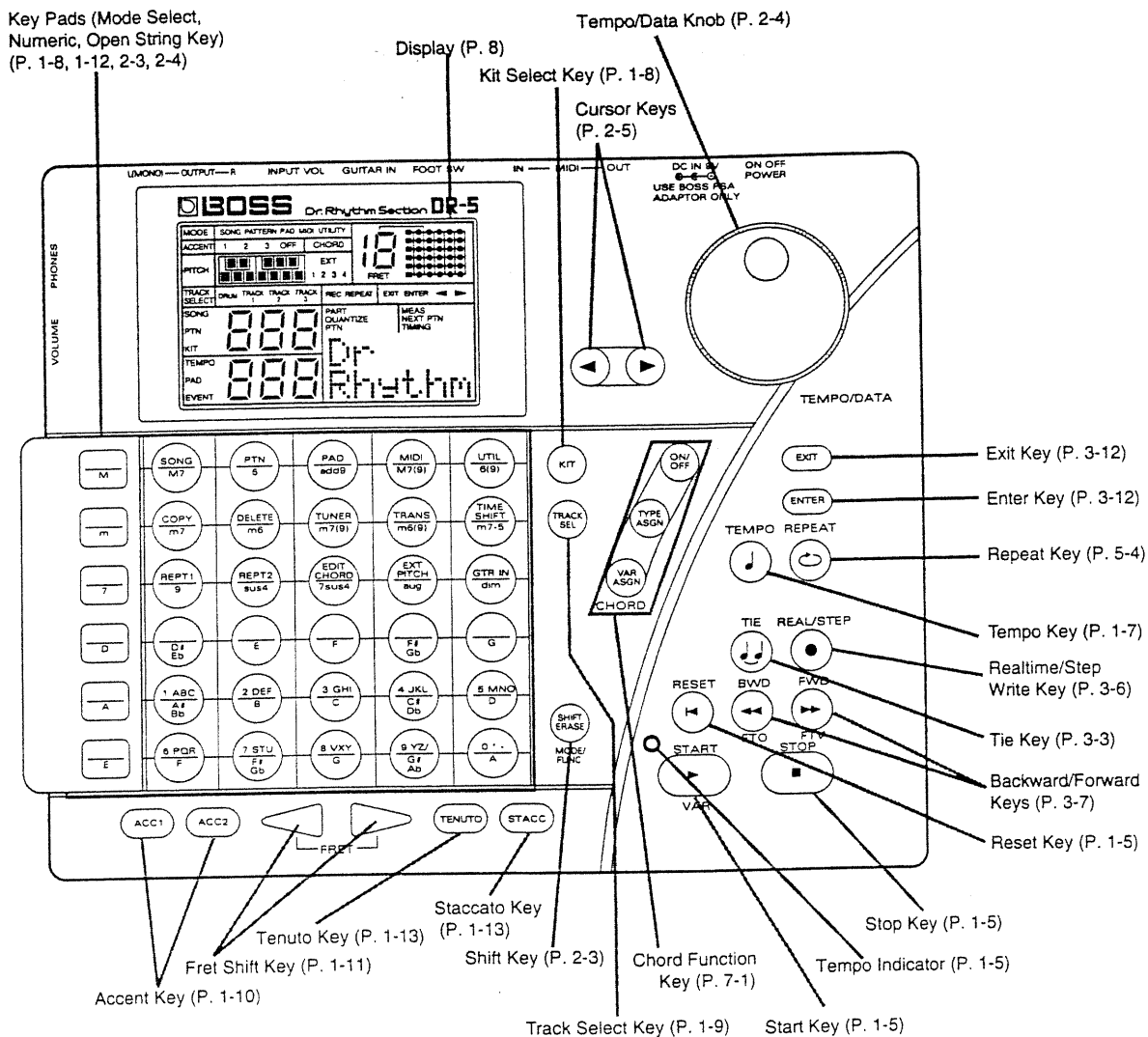

Rear Panel

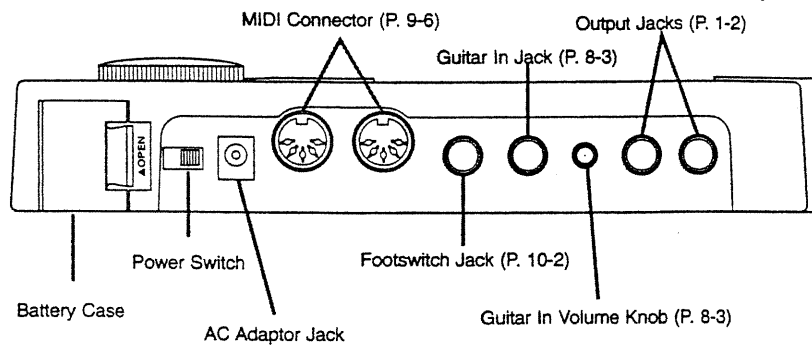

Side Panel

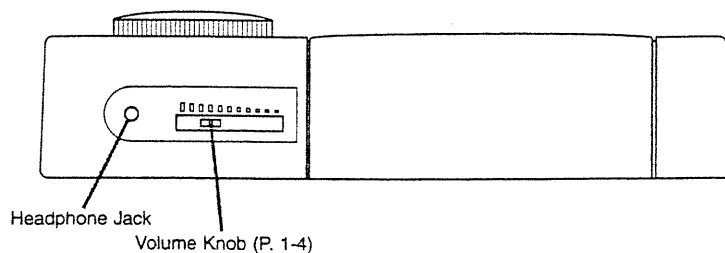

Display

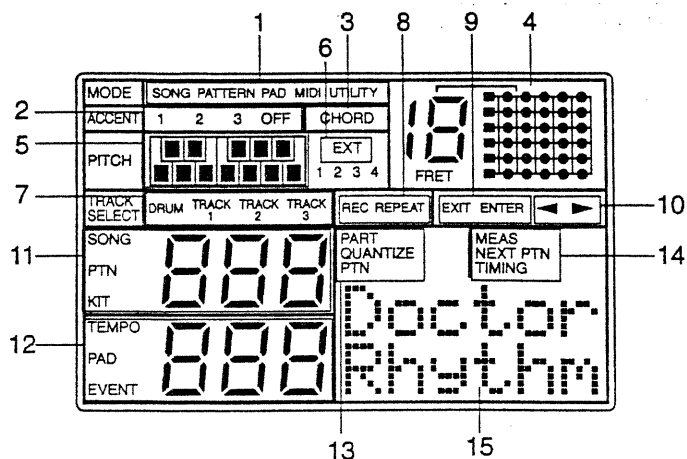

1. Mode Display

Displays the current status of the unit.

2. Accent Display

Displays Accents for Events (p. 3-10) when in the Step Edit mode.

3. Chord Mode Display

Lights when the chord input mode is turned ON.

4. Chord Position Display/Fret Number

When a chord is specified using the chord input mode, its position is shown by the corresponding indicators which light in the Chord Position Display.

The fret number indicates the fret number of a chord specified when in the chord input mode. At other times, it indicates the number of the fret to which a key pad corresponds.

5. Pitch Display

The pitch of an event is displayed when using Step edit. It also displays the pitch of the signal input to GUITAR IN when the Tuner function is being used.

6. External Pitch Display

Lights when External Pitch function is turned ON.

7. Track Select Display

Displays the currently selected Track.

8. REC/Section Repeat Display

REC lights when in the recording mode for songs and patterns.

REPEAT lights when the Section Repeat function is ON.

9. EXIT/ENTER Display

Lights when the [EXIT] and [ENTER] keys can be used.

10. Cursor Indicator

Indicates the direction in which the cursor ([<|/>]) will function.

11. Song/Pattern/Kit Number Window

Displays the Song Number when in the Song mode, the Pattern Number when in the Pattern mode, and the Kit Number when in the Kit mode.

12. Tempo/Pad/Event Number Window

Displays the tempo when in the Tempo Edit mode (or the like), the Pad Number when in the Pad mode (or the like), and the Event Number while using Step Edit.

13. Part Number/Quantize/Pattern Number Sub Window

Shows the contents of the upper-left 3 segments of the message window.

14. Measure/Next/Timing Sub Window

Shows the contents of the upper-right 3 segments of the message window.

15. Message Window

This window displays the contents of parameters.

Chapter 1

Playing the Unit

(1) Preparation

1. Making the Connections

** Before making any connections, be sure that all the units in your system are turned OFF.
If you make connections while power is ON, damage or malfunction could occur.*

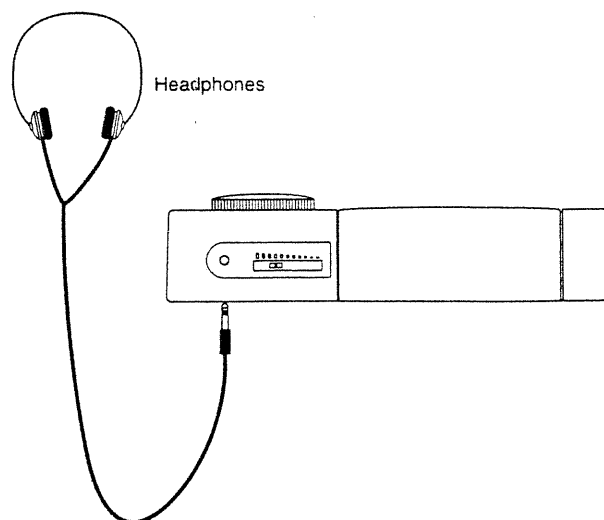
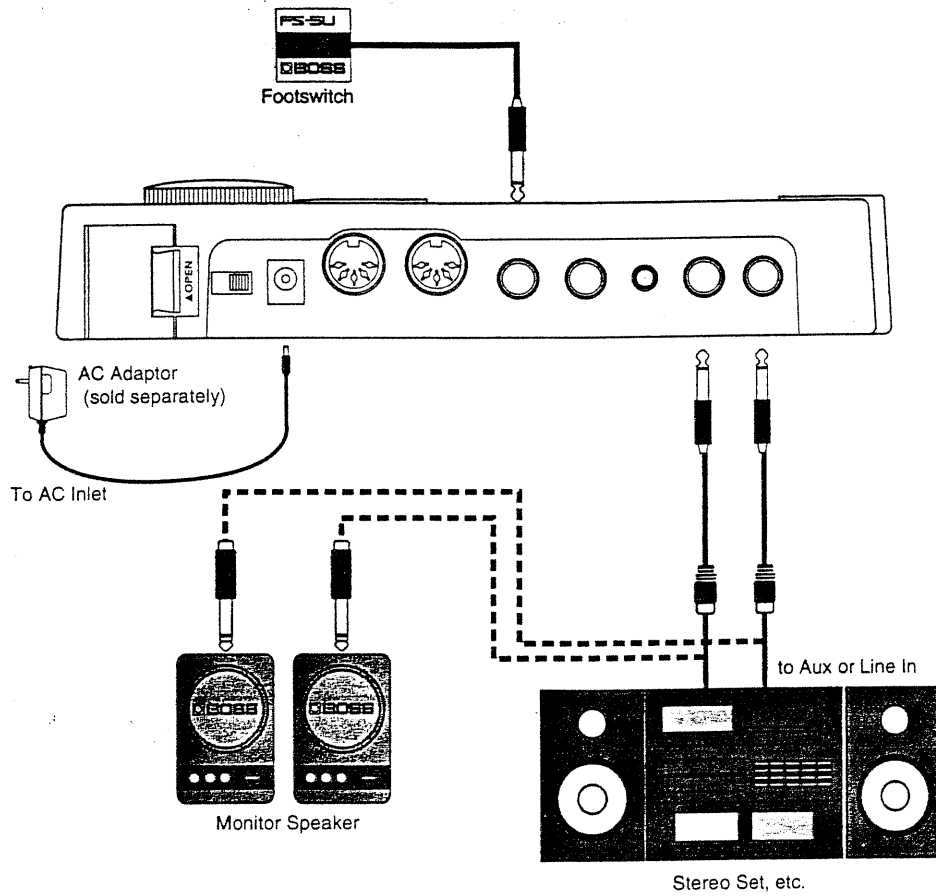

To enjoy the best possible performance from this unit, we recommend that you use a stereo output (R/L).

Please refer to page 9-6 for information about MIDI connections.

2. How to insert batteries

* Six "AA" batteries (1.5 V) are required.

- (1) Check that the power switch is set to OFF.

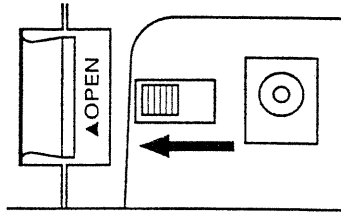

- (2) Remove the battery cover on the rear panel.

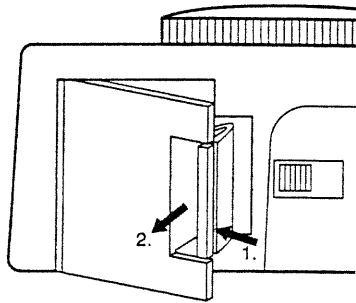

- (3) Remove the batteries from the battery case. While carefully observing their polarity (+/-), insert fresh batteries.

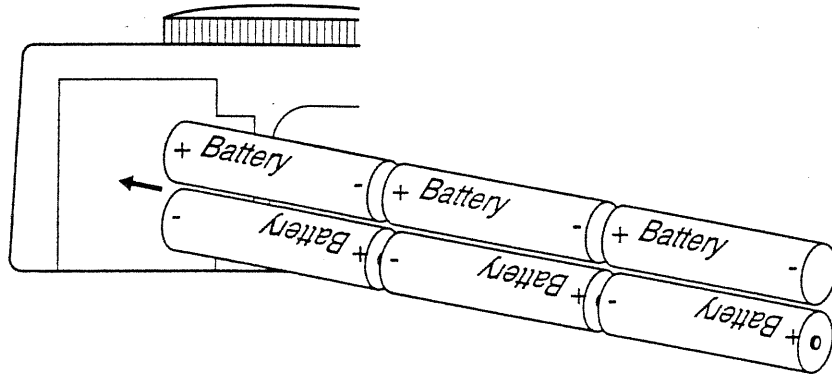

- (4) Close the battery cover.

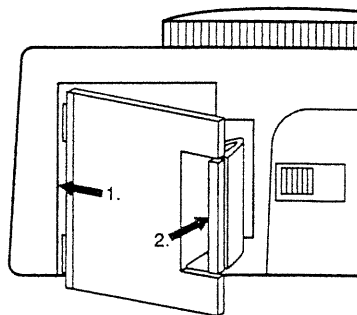

3. Powering Up

Once you have finished making the connections, you are now ready to turn on the power. Follow the steps below.

(1) Check again to make sure you made the connections correctly, and that all units in the system are OFF.

(2) Turn ON the DR-5. Next, turn ON the power to your amplifier and other devices.

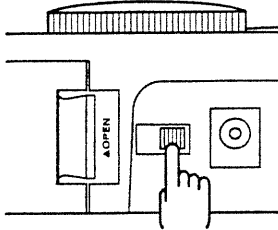

(3) Set the volume to an appropriate level.

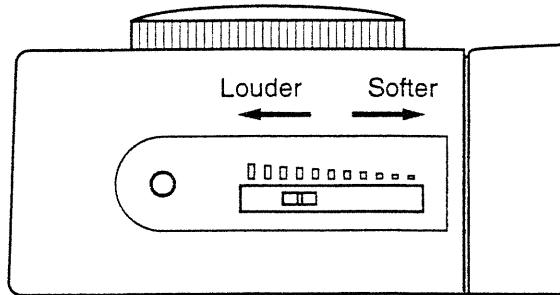

* When powering down, turn OFF the external devices first, then the DR-5.

* This unit is equipped with a protection circuit. A brief interval (a few seconds) after power up is required before the unit will operate normally.

(2) Demo Song Playback

A Demo Song is stored in the DR-5. It was created to take full advantage of the capabilities of the unit. Use the following procedures to listen to the Demo Song.

- (1) Select the Song mode (mode where songs can be played).

Press [SONG] while holding down [SHIFT ERASE] and confirm that "SONG" has been displayed.

MODE	SONG
------	------

- (2) Select the Song to be played using the TEMPO/DATA knob.

The Demo Song is stored at Song No. 20.

SONG	20	PART	MEAS
TEMPO	120	001001	Circus

- (3) Press [START].

Playback begins. The tempo indicator will flash on every beat.

- (4) Press [STOP].

Play will stop.

Press [START] again and play starts from the place where it was stopped (Continue Play). If you first press [RESET] and then press [START], play starts from the beginning of the song.

Circus Music by Atsushi Hoshika Copyright © 1993 Roland	Atsushi Hoshika Atsushi Hoshika is a member of one of Roland's engineering teams. He performed an important role in the development of the R-70, as well as the R-8 and the DR-550. He has also directed his talent toward the creation of demonstration songs for the R-5 and the R-8.
---	--

** This demo song is protected by applicable copyright laws. It is intended for demonstration purposes and personal enjoyment only. Reproduction of this song, or use for any other purpose, is prohibited.*

(3) Listening to Patterns

The DR-5 contains 200 different Preset Patterns (musical patterns) in memory. To listen to these patterns, use the procedure below.

1. Pattern Play

- (1) Select the Pattern mode.

Press [PTN] while holding down [SHIFT ERASE] and confirm that "PATTERN" has been displayed.



- (2) Select the Preset pattern to be played (Numbers 000-199) using the TEMPO/DATA knob. The pattern number and pattern name are shown in the display. (To play a programmable pattern, select a number from 200-399.)

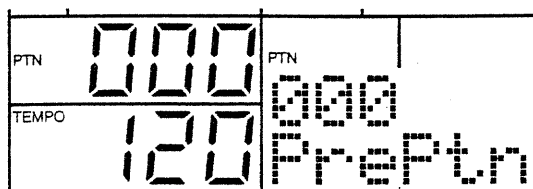

Pattern to be played (Pattern Name)

- (3) Press [START].

Play will start. The tempo indicator will flash on every beat.

If you select a new pattern number while the first pattern is playing, the Next Pattern Number and the Pattern Name will be displayed. This newly selected pattern will then be played after the current pattern has finished.

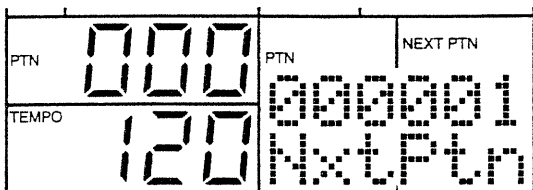

Pattern to be played next (Pattern Name)

- (4) Press [STOP].

Play will stop.

Press [START] again, and play will start from the place where it was stopped (Continue Play). Press [RESET] before pressing [START] when you want play to start from the beginning of the pattern.

2. Adjusting the Tempo

The following setting allows you to alter the tempo at which a pattern plays. (Range for the setting: 40-250 beats per minute.)

- (1) Press [TEMPO].

"TEMPO" will be displayed.

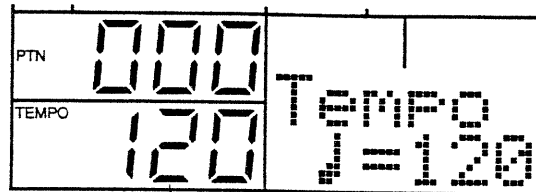

Tempo

- (2) Adjust the tempo using the TEMPO/DATA knob.
 (3) Once you have the desired tempo, press [TEMPO].

3. Muting Tracks

Each Instrument (drums, guitar etc.) in a pattern on the DR-5 has its own "Track." Any of these Tracks can be muted whenever you wish to silence the sound of a particular Instrument.

* *For more information about Tracks, please refer to "[4] 2. Switching Tracks." (p. 1-9)*

- (1) Select the utility mode.

Press [UTIL] while holding down [SHIFT ERASE] and confirm that UTILITY has been displayed.

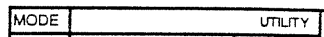

- (2) Use [←]/[→] to switch the page. Confirm that "Mute" has been displayed.

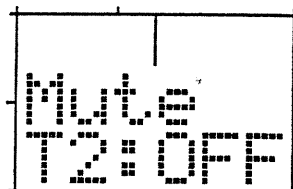

- (3) Select the Track to be muted using the TEMPO/DATA knob. (DRUM/ T1 to 3)
 (4) Use [←]/[→] to move the cursor, then use the TEMPO/DATA knob to turn the Track ON/OFF.
 When you wish to mute the Track, set Track Mute to "ON."

(4) Tapping the Key Pads to Produce Sound

Try tapping the key pads to play the Instruments contained in the DR-5.

When you hit the key pads, you can either obtain the particular sound (Instrument) that is assigned to each pad, or you can obtain the same Instrument sound, but in different pitches (depending on the pad you hit).

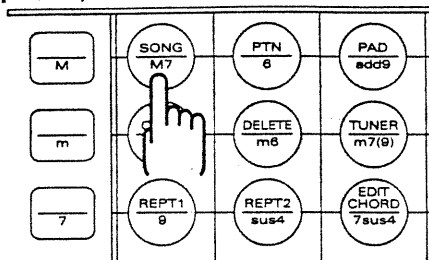

1. Switching the Kit

A Kit is a group or collection of 33 Instruments selected from the 256 that are contained in the DR-5.

A Kit can be considered as being much like a band, having a drum set, bass, guitar, and keyboards. The DR-5 provides 48 Preset Kits, and allows you to create 16 custom Kits (User Kits).

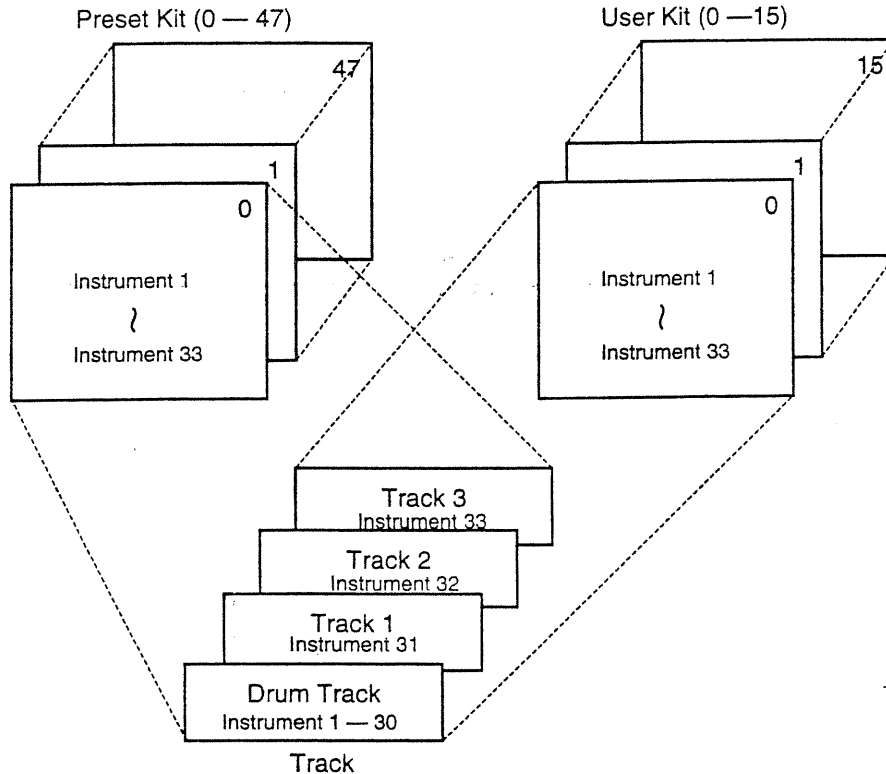

For more information, refer to Chapter 2, “[4] What Are Kits?” (p. 2-6).

- (1) Press [KIT].

"KIT" will appear in the left part of the display, indicating that the Kit can now be changed.

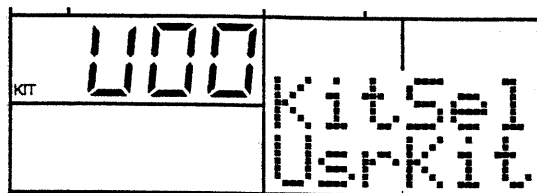

- (2) Select a Kit number using the TEMPO/DATA knob.
(Preset Kits/P00 to 15; User Kits/U00 to 15)
- (3) When you have finished selecting the Kit, press [KIT].
You will be returned to the previously selected mode.

2. Switching Tracks

Within each Kit there are four Tracks: DRUM, TRACK1, TRACK2, and TRACK3. With the DRUM Track, the key pads can be used to play a percussive performance. The other TRACKS are used for playing melodies (or for playing chords, see p. 2-7).

- (1) You can switch successively to DRUM, TRACK1, TRACK2, or TRACK3 with each press of [TRACK SEL].
The name of the selected Track is displayed at the "TRACK SELECT" position in the display.

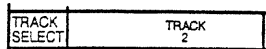

3. Accents

Accents (which express the loudness of a note) can be applied to each individual note.

There are three kinds of Accents which you can use:

[ACC1] pressed alone.

[ACC2] pressed alone.

[ACC1] and [ACC2] pressed together. (Acc3)

To have an accent applied to an Instrument or note, hold down one or both of the above keys while you tap the appropriate key pad.

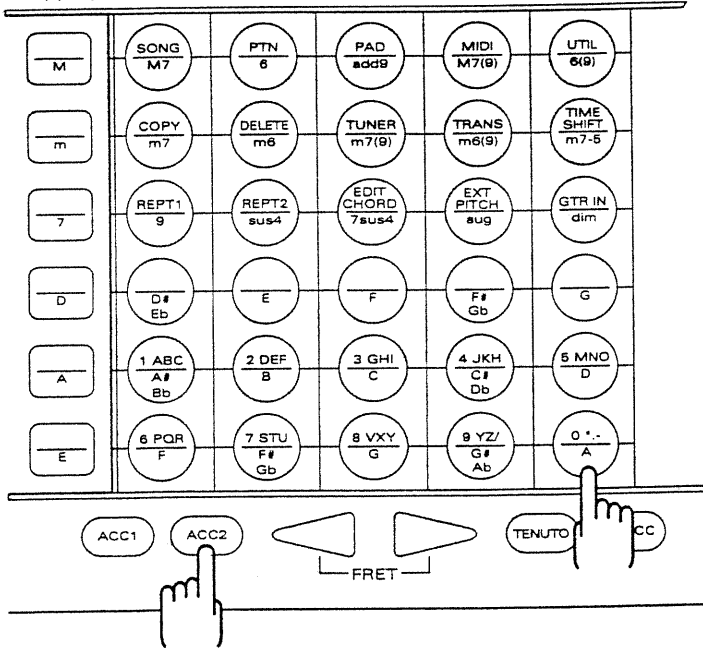

The intensity of the accent will be as follows:

ACC3 < ACC2 < NO ACCENT < ACC1
 [Display] 3 2 OFF 1

4. Fret Shift

The key pads can be used to play melodies (in Tracks other than the Drum Track). Each of the key pads then corresponds to a fingering position on a guitar. To alter the sound's pitch, you can change the fret number that the key pads correspond to. (Much like changing positions by moving your hand up or down the neck of a guitar.)

* *When manufactured, the Key Pad layout for the scales is set to match the most common form of guitar tuning. (This layout can be changed by altering the settings for "Align," p. 6-6).*

- (1) Press [**<**]FRET[**>**] (when a Track other than DRUM is selected) to alter the pitch of the notes that will be produced by the key pads.
With each press, the pitch is shifted. The amount of shift can be set over the equivalent range of 12 frets.

Example case) The column of pads at the farthest left on the unit is currently set to 11 fret. And the amount of shift possible is set at 7 (frets).

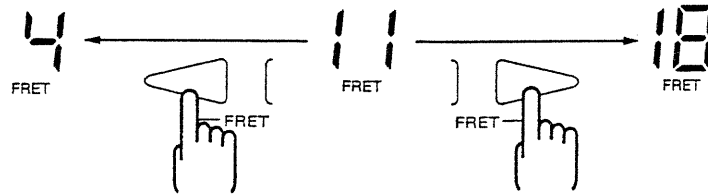

For instruction on how to set the amount of shift, please refer to Chapter 10, "[2] Adjusts the Amount of Fret Shift (P.10-3)".

In the upper-right part of the display, the fret number will be shown. This number represents the equivalent guitar fret you will obtain with the column of pads at the farthest left on the unit (1-19).

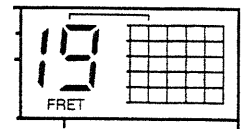
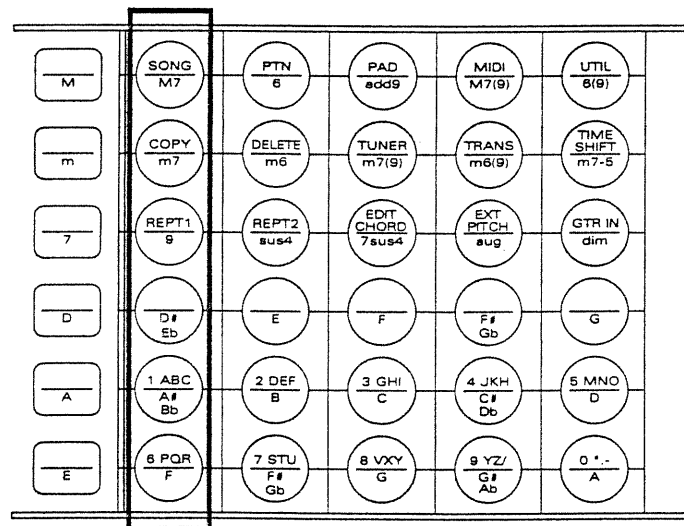

... the display will read "19."

When you set this column to the 19th fret...

* *If you press [**<**] FRET [**>**] while holding down [SHIFT ERASE], the pitch will be shifted by a semitone (one fret).*

5. Open Strings (Open String Keys)

The DR-5, of course, allows you to play different pitches depending on the key pad that is tapped. It also allows you to play the open string pitches (E, A, D, G, B, E) as well. To do so, you use the six square keys (Open String Keys) on the far left.

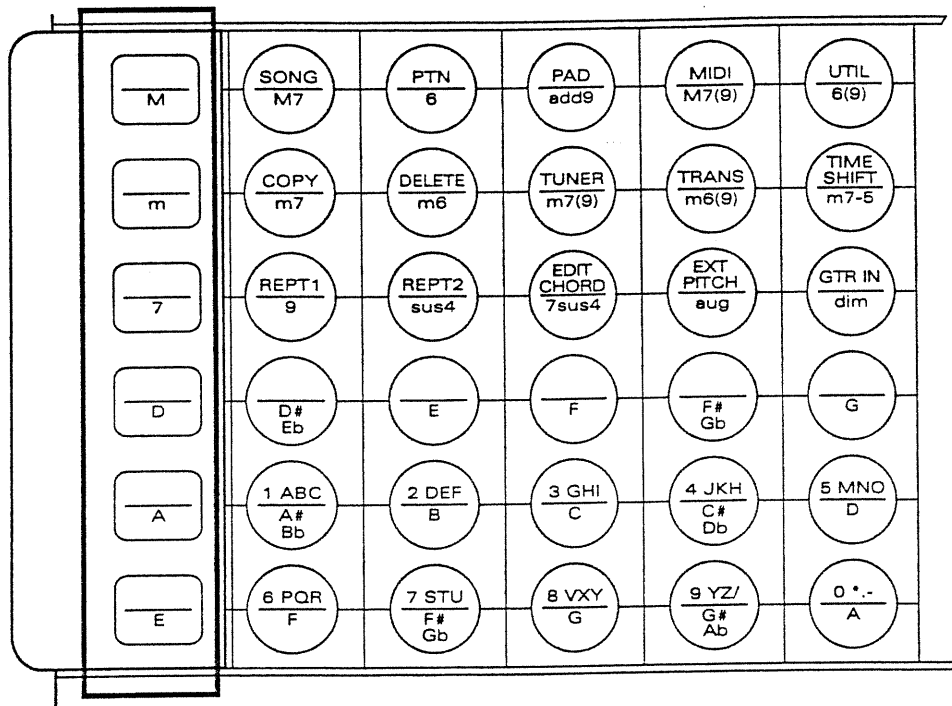

Open String Keys

--- The pitch of these six keys will not change even when you perform fret shifts.

* When the DRUM Track is selected, sound will not be produced when you press an Open String key.

6. Sounding Notes Briefly (Staccato)

A staccato effect can be applied on an individual note basis.

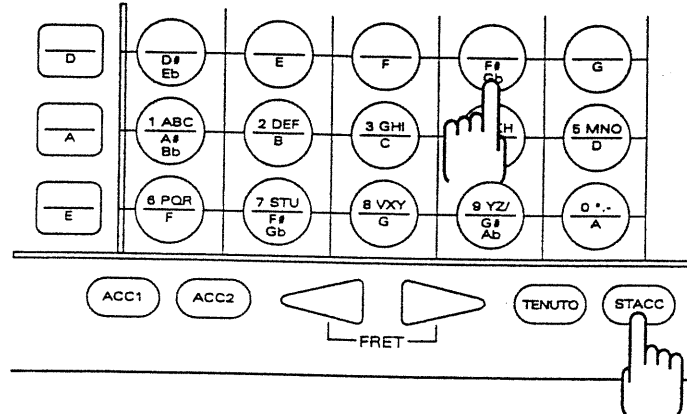

Tap a key pad while holding down [STACC] and that note will be made staccato, regardless of how long you actually press the pad.

7. Sounding Long Notes (Tenuto)

A tenuto effect can be applied on an individual note basis.

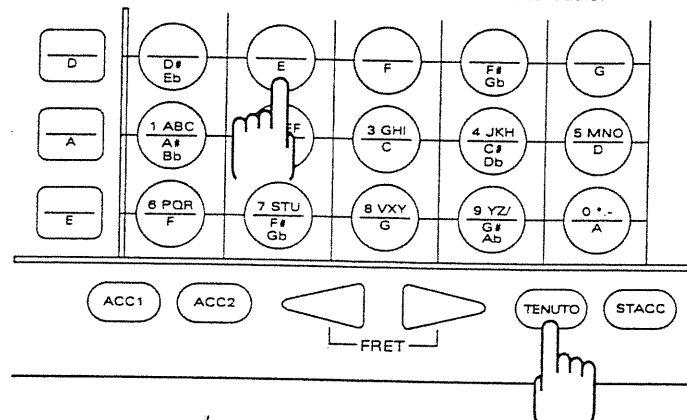

Tap a key pad while holding down [TENUITO] and that note will be made tenuto (full value), regardless of how long you actually press the pad.

Chapter 2

**Overview of the DR-5
(Learning how patterns are created.)**

(1) Creating Patterns

When using the DR-5 to create a song, the following are the two major steps that are involved.

Pattern Write (p. 3-1)

First you need to create the smaller, component performance patterns. There are two methods by which this can be done. With Step Write, you input the timing and pitch for each note (or chord), for each sound. In the other method, Real-time Write, you input the pattern by actually tapping out the rhythm on the key pads, in time with the metronome. Alternately, you can play the pattern on a guitar you have connected.

Song Write (p. 4-1)

Song Write involves setting up the desired order for patterns created using Pattern Write, which can be combined with any of the preset patterns.

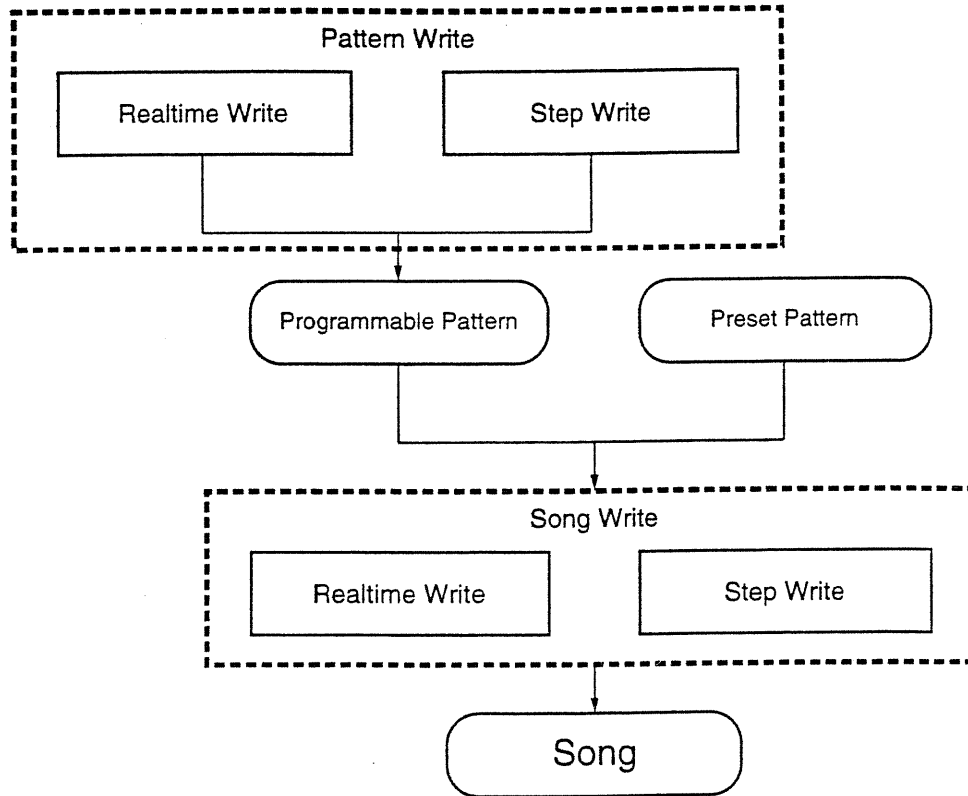

(2) Organization of the DR-5

- ↳ The DR-5 is equipped with numerous functions that are useful when creating patterns and songs, and when editing sounds. These functions are organized into 5 modes:

Song Mode

Used to play, create, and edit songs.

Pattern Mode

Used to play, create, and edit patterns.

Pad Mode

Used to assign Instruments to each key pad, and make the settings which affect how the Instruments will sound.

MIDI Mode

This mode is used to make the relevant settings when wishing to connect an external sound module, use the DR-5 as a MIDI sound module, or send performance data to an external sequencer.

Utility Mode

This mode is used to alter the settings for the metronome, Footswitch, Track mute, fret shift, and check how much memory remains (so you know how many more patterns or songs can be stored).

(Changing the Mode)

With play stopped, hold down [SHIFT ERASE] while you then press one of the mode buttons ([SONG]/[PTN]/[PAD]/[MIDI]/[UTIL]; located along the top row of the key pads)

(3) Altering Numeric Values (Settings)

Use either the TEMPO/DATA knob or a number/letter/symbol button when you need to select a number or the value of a parameter setting, the same as you would when selecting a pattern or song.

TEMPO/DATA Knob

Used to make large changes in a value. The amount of consecutive change you obtain depends on how fast the knob is rotated.

Number/Letter/Symbol Buttons (The bottom two rows of key pads)

Used when you wish to directly specify numeric values, letters, or symbols.

The corresponding value is input when you press a number/letter/symbol button while holding down [SHIFT ERASE].

The letters/symbols on a button can be selected using the button when you are inputting a Pattern Name (p. 3-4) or a Song Name (p. 4-2).

When you press a number/letter/symbol button while [SHIFT ERASE] is held down, you will obtain one of the characters that it offers. Each time the button is pressed, you obtain the next character in the series.

For example, if you use the first pad key in the row that is second from the bottom:

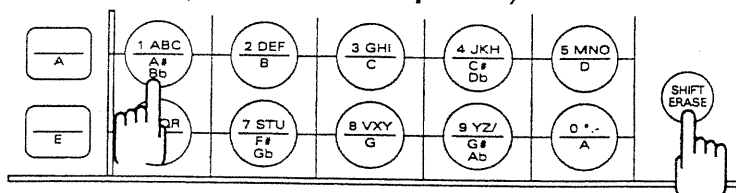

Each time you press the key, you obtain the next character within this sequence: 1 → A → B → C → a → b → c

Each mode can offer a number of pages. The message window at the lower-right of the display always indicates which page you are in at that time.

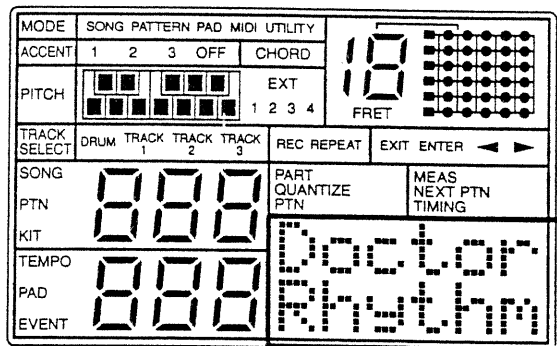

Message Window

Use [←]/[→] to switch between pages. Changes in the value of settings within each page can be made using the TEMPO/DATA knob or the number/letter/symbol buttons. (The bottom two rows of key pads.) Sometimes, there will be more than one parameter on the same page. In such cases, you need to use [←]/[→] to move the (flashing) cursor and make settings for the values.

Example)

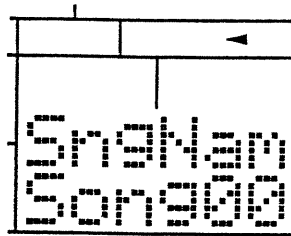
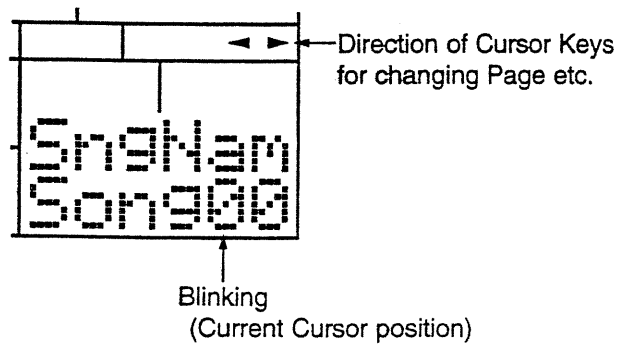

(4) What Are Kits?

A Kit is a group of 33 Instruments (selected from the 256 available), assigned to the DRUM Track and Tracks 1 — 3. You can think of a Kit as being like a band, possibly having a drum set, bass, guitar, and keyboards.

Among the 33 sounds, drum and percussive sounds can be played on the DRUM Track, and any other Instruments can be played on Tracks 1 - 3. When you change to a different Kit, all of the Instrument sounds produced by all of the Tracks can be changed. Such changes can be thought of as having one band finish and another one come up!

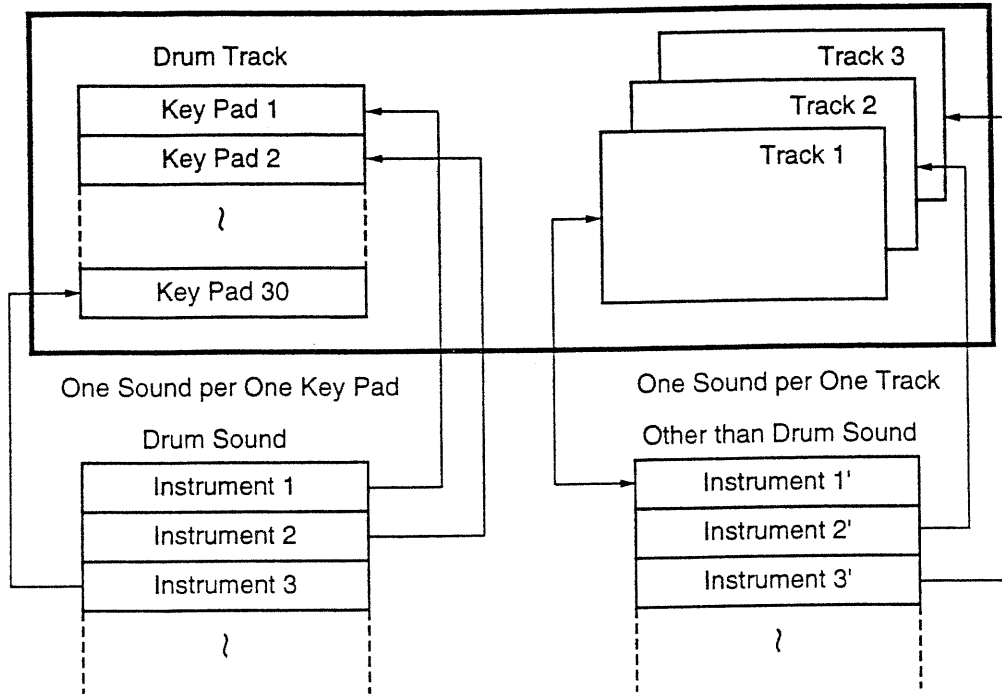

The DR-5 contains a selection of Preset Kits, and in addition allows you to create your own, custom Kits (User Kits). You can even edit the sound of the Instruments that are assigned to a User Kit. Such edited Instruments are treated like new Instruments that the unit has acquired (in addition to the ones it originally contained).

(Changing Kits)

- (1) Press [KIT].
- (2) Select the desired Kit using the TEMPO/DATA knob.
- (3) Once completed, press [KIT] again.

(5) Using the Key Pads

The DR-5 has 36 key pads. These key pads can perform three different roles:

1. They can be played (like those on a conventional drum machine) after a percussion sound has been assigned to each.
2. They can serve as the 'frets' and 'strings' of a guitar, allowing melodies to be played.
3. They can be used to designate the root and chord type when playing chords.

Patterns can be conveniently created by combining the use of these three methods.

(How to Play Drums)

- (1) Using [TRACK SEL], select the Drum Track.
Select "DRUM" next to TRACK SELECT in the display.
- (2) Tap the key pads to play something.

* *The Open String Keys (p. 1-12) cannot be used with the DRUM Track.*

(Playing Melodies)

- (1) Using [TRACK SEL], select TRACK 1-3.
Select "TRACK 1-3" next to TRACK SELECT in the display.
- (2) Check that the unit is not set to allow chord performances.
Make sure that "CHORD" is not displayed at the top-middle of the display. If it is displayed, press CHORD [ON/OFF] so it no longer appears.
- (3) Tap the key pads and play something.

(Playing Chords)

- (1) Using [TRACK SEL], select TRACK 1-3.
Select "TRACK 1-3" next to TRACK SELECT in the display.
- (2) Select the Chord Performance mode.
Press CHORD [ON/OFF] and confirm that "CHORD" has appeared at the top-middle of the display.
- (3) Specify the chord.
Specify the root note using one of the key pads in the three lower rows (hold the button down), then press whichever key pad in the upper three rows you need to obtain the desired chord type.

Chapter 3

Creating Patterns

(1) Pattern Write Procedure

The following two methods are available for performing a Pattern Write.

Realtime Write

Using Pattern Write you can supply the input needed to create a pattern by tapping out a rhythm on the key pads or by playing a guitar (Chapter 8, "Using a Guitar for Input," p. 8-1). You do not need to worry if your timing is somewhat off, since you can simply use the Quantize function (p. 3-4) to correct the inaccuracies afterwards. Data from an external MIDI unit can also be used for input (p. 9-6).

** Note that the sound of the guitar itself is not what is recorded.*

Step Write

When using Step Write you need to individually input each note that occurs in the pattern, for every instrument that is used. This method is convenient for those who have difficulty with Realtime input.

Patterns can, of course, be created by alternating between both methods. You could create the basic pattern first using Step Write, then use Realtime write to add other sounds. Or you could play the pattern using Realtime input first, then improve the pattern by using Step Write to polish it up in places.

(Parameters Stored in Patterns)

The parameter settings that can be stored within a pattern are as follows:

Common to all Tracks:

Timing
Accent

Tracks 1-3 only:

Pitch (0 — 63) Pitch (in semitone steps)
Gate Time (1 — 768) Length of notes (1 — 48; 1-step increments. 52 — 768; 4-step increments)

(The number of notes which can be entered at the same timing)

A maximum of 9 sounds can be entered at the same timing position in a Track. However, when the total number of notes (of all Tracks) entered at the same timing position exceeds 19 (maximum polyphony), the unit will not sound correctly.

About Gate Time

(Example)

Realtime Write --- Time between pressing a Key Pad and releasing it. (= Gate Time)

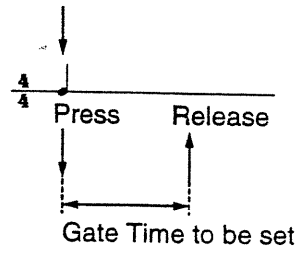

Step Write --- Quantize (= Gate Time)

(Quantize = ♩)

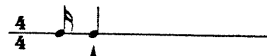

Enter the quarter note without changing the Quantize.



Press the Tie Key (Ⓢ) while holding down the Key Pad.

1. Initial Settings for Pattern Write

Before beginning a Pattern Write, the unit needs to be set to the initial settings common to both Real-time Write and Step Write.

Time Signature

The desired beat (time signature) must be selected for every pattern.

Pattern Name

Each Pattern can be given a name that consists of up to 6 characters.

Quantize

Used with Realtime Write, this feature corrects the timing inaccuracies that may have occurred when playing the key pads.

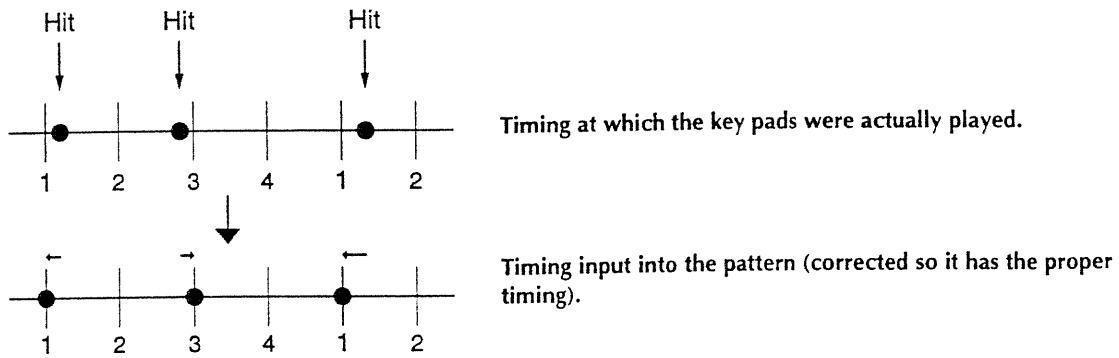

When using Step Write, you need to specify the degree of precision you want by selecting the smallest unit into which a single beat is to be divided. This setting is made by specifying the value of the smallest note.

Display	Note	Display	Note	Display	Note
	Quarter Note		Quarter Note Triplet		Eighth Note
	Eighth Note Triplet		Sixteenth Note		Sixteenth Note Triplet
	Thirty-second Note		Thirty-second Note Triplet	H	$\text{♩} = 48 \text{ clocks}$

(Making the settings)

- (1) Select the Pattern mode.

Press [PTN] while holding down [SHIFT ERASE] and confirm that "PATTERN" has been displayed.

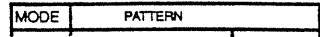

- (2) Select the user pattern (number) for which the settings are to be made using the TEMPO/DATA knob (200 — 399).

** You cannot select any of the Preset patterns (000-199).*

- (3) Press [←]/[→] to switch the page. Confirm that "T.Sign" has appeared in the display.
- (4) Select the beat using the TEMPO/DATA knob. (1/4 to 16/4, 1/8 to 32/8, 1/16 to 64/16)

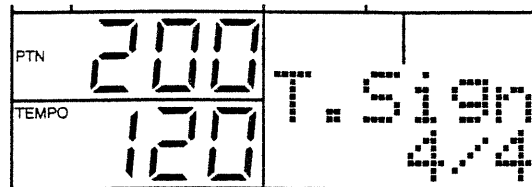

- (5) Press [←]/[→] to switch the page. Confirm that "PtnNam" has appeared in the display.
- (6) Press the appropriate number/letter/symbol button(s) while holding down [SHIFT ERASE] to input the Pattern Name.
Use [←]/[→] to move within the available range of characters.

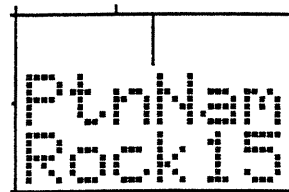

In the following you will learn how to create patterns, using Realtime Write and Step Write. You can, of course, also create patterns while combining both methods. Whenever the unit is placed in recording standby, the first thing you need to do is make the setting for Quantize.

** If you need, you can change the beat setting made in Step 4 after you are finished inputting the data. Note, though, that this may make it impossible for certain portions of the data to be played.*

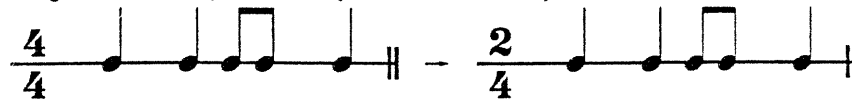

In such cases, "?" will appear in the left part of the display.

When you press [ENTER], the beat for the pattern is changed, while portions that can no longer be played will be erased.

2. Realtime Write

* *Before beginning a Realtime Write, the unit needs to be set to the initial settings for a Pattern Write (p. 3-4).*

- (1) Press [REAL/STEP] to enter recording standby for Realtime Write.

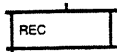

- (2) Make the setting for Quantize using the TEMPO/DATA knob.

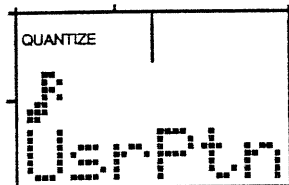

- (3) Select the Track (p. 1-9) and Kit (p. 1-8) appropriate to the pattern you intend to create.

Track: Press [TRACK SEL]

Kit: Press [KIT] → Rotate TEMPO/DATA knob → Press [KIT]

- (4) Press [START].

The tempo indicator will flash in time with the beat, and the metronome will sound (Metronome settings: p. 3-18).

- (5) Adjust the metronome to a comfortable tempo.

Press [TEMPO] and make settings for the tempo (40-250 bpm) using the TEMPO/DATA knob. Once the setting has been made, press [TEMPO] again and return to Realtime Write.

- (6) Tap the key pad to which the Instrument to be input is assigned while listening to the metronome. (You could also use the key pads to play a melody: Tracks 1-3)
Whatever notes have been input will be played repeatedly.
During the input procedure, you can also switch Tracks (p. 1-9) in order to input other Instrument sounds.

When you feel that it is necessary, you can hold down [ACC1] or [ACC2] while you tap a key pad. This will cause accents to be applied to the Instrument or melody.

Also, when using Realtime Write, staccato notes and tenuto notes can be input. Since it is only the gate time that has been changed when these features have been used, you can go in and change them afterwards if necessary, using Step Edit (p. 3-10).

- (7) Press [STOP] once you have finished with what you intend to input.

* *The number of the Kit used during input will be stored along with each pattern. If you have switched the Kit while creating a pattern, the number of the Kit that was last selected will be stored in the pattern. Therefore, when played back, the pattern will play using the Instruments that are in that Kit number.*

(When you have made a mistake during input)

In the case of the Drum Track, press the key pad for the Instrument that you want to erase while you hold down [SHIFT ERASE].

Every instance of that sound that occurs while you have the pad pressed will be erased.

In the case of Tracks 1-3, sound will be erased when you press any key pad while holding down [SHIFT ERASE]. All notes, regardless of their pitch, that occur while any pad is pressed will be erased.

3. Step Write

* Before beginning a Step Write, the unit needs to be set to the initial settings for a Pattern Write (p. 3-4).

- (1) Press [REAL/STEP] to enter recording standby for Step Write.
- (2) Make the setting for Quantize using the TEMPO/DATA knob.
- (3) Select the Track (p. 1-9) and Kit (p. 1-8) appropriate to the pattern you are about to input.

Track: Press [TRACK SEL]

Kit: Press [KIT] → Rotate TEMPO/DATA knob → Press [KIT]

- (4) Press [START] to start the Step Write process.

The tempo indicator lights.

- (5) Specify the step to be input using [FWD]/[BWD].

The timing of what will be input (the number of beats from the pattern's beginning (Beat Number), and the number of clocks in the current Beat Number) is shown in the lower-right part of the display.

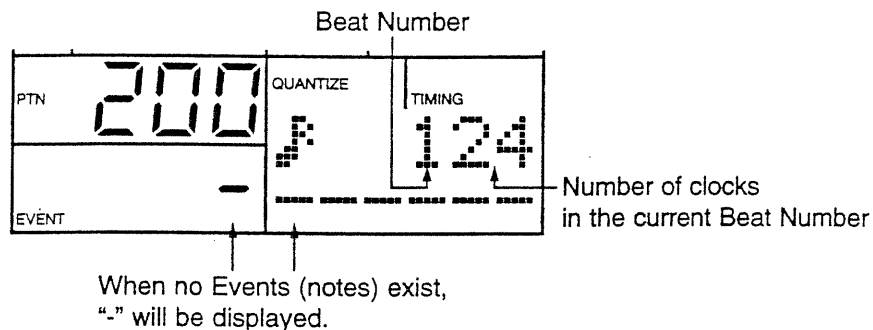

Quarter notes can be further divided into a maximum of 48 parts (Quarter notes = 48clocks). The total number of notes that can be included in one pattern will vary depending on the value that has been set for Quantize.

Display	Gate Time	Display	Gate Time	Display	Gate Time
♪	48	♪ ₃	32	♪	24
♪ ₃	16	♪	12	♪ ₃	8
♪	12	♪ ₃	4	H	1

(Ex.) When Quantize is set to a quarter note:

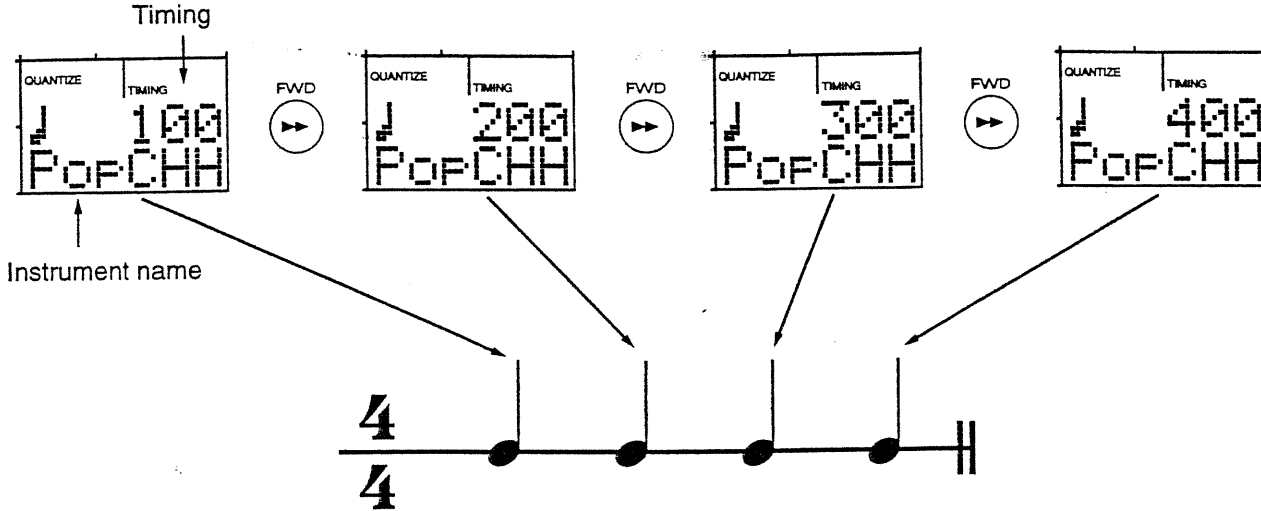

(6) Tap a key pad and input an Instrument.

(7) Press [FWD].

(8) Should you wish to input another Instrument into the same Track, repeat steps (5) and (6) above.

With Step Write, when you want to input notes of a duration longer than the gate time set using Quantize, you should use the [TIE] key. Tap [TIE], and the gate time of the current input note will be changed.

For Example, when Quantize is set to an eighth note, after inputting a note, holding down the Key Pad and pressing [TIE] will create a quarter note (the value of one eighth note tied to another).

(9) Press [STOP] once you have completed inputting your pattern.

(When you have made a mistake during input)

Press [DELETE] while holding down [SHIFT ERASE].
You can erase only the displayed event.

If you follow this procedure when play is stopped, you can erase the pattern (p. 3-12).

4. Entering Chords

When you have any Track other than the Drum Track selected (TRACKs 1 — 3), chords can also be entered in addition to melodies. In this case, the component notes of the specified chord are written into the pattern.

For details about the unit's chord features, see Chapter 7, "Using the Chord Functions" (p. 7-1).

- (1) Set the unit to the initial settings for a Pattern Write (p. 3-4).
- (2) Select the Chord Input mode.
Press CHORD [ON/OFF] and confirm that CHORD has been displayed.

CHORD

- (3) Input a chord.

The methods used for recording for Realtime and Step Write are the same. Instead of tapping a pad and inputting an Instrument, you specify a chord to be input. Specify the root note using the three lower rows of the unit's 36 key pads (hold a key pad down), then press whichever key pad in the upper three rows you need to obtain the desired chord type.

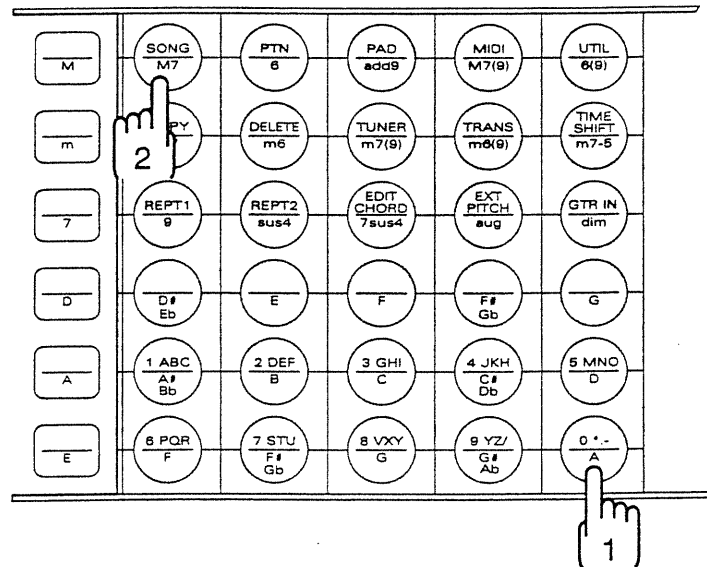

Accents can also be applied (p. 1-10).

- (4) Once again press CHORD [ON/OFF].
This exits the Chord Input mode.

5. Step Edit Mode

At times you may have made a mistake in the pitch of a note you entered, or you may not be satisfied with the results you get from the accents you have added. The Step Edit mode allows you to make corrections and changes in the pitch and accent.

Every sound that occurs at a particular point in time (including settings for pitch and the accent) is known as an "event." Events can often be likened to notes. When there are two sounds that occur at exactly the same time (for example, snare and bass drum; or 'do' and 'mi'), then two events exist at that time location.

- (1) Press [REAL/STEP] to enter recording standby for Step Write.
- (2) Using [FWD]/[BWD], select the time location for which you want to make changes; it will appear in the display.

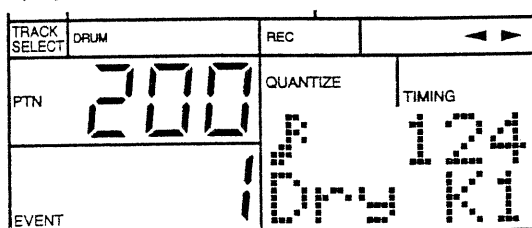

In the case of the Drum Track:

- (3) Using [←]/[→], move the cursor to the place where the Instrument name is shown.
- (4) Make changes in the Instrument using the TEMPO/DATA knob.
- (5) If you press [→], the accent will be displayed next.

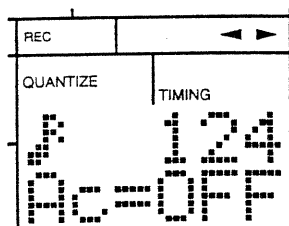

- (6) Make changes in the accent using the TEMPO/DATA knob.

In the case of Tracks 1 - 3 :

- (3) Using [\leftarrow]/[\rightarrow], move the cursor to the pitch display.

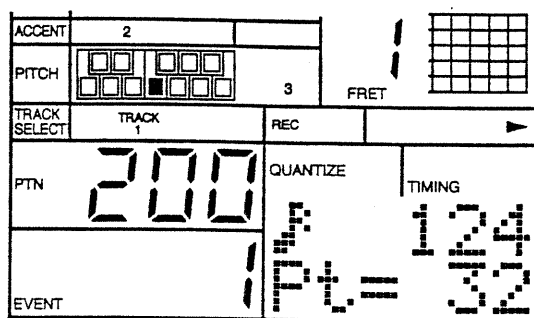

- (4) Make changes in the pitch using the TEMPO/DATA knob.
- (5) Press [\rightarrow].

The accent is displayed.

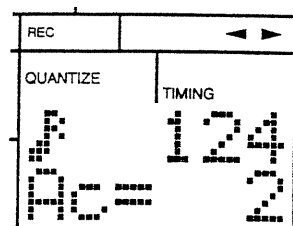

- (6) Make changes in the accent using the TEMPO/DATA knob.
- (7) Press [\rightarrow].

The gate time is displayed.

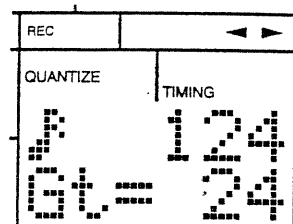

- (8) Make the change in the gate time using the TEMPO/DATA knob.

When two events have been input at the same time location, once again press [\rightarrow], and the pitch (or Instrument) constituting the second event will be displayed.

In this manner, when numerous events are located at the same time location, you can continue pressing [\rightarrow] to view the pitch of the next event (or Instrument), then the accent, gate time.

** Up to 8 events can be input at the same location.*

When you wish to delete unneeded events, first get the event you want to erase to appear while playing (or writing), then press [DELETE] while holding down [SHIFT ERASE].

(2) Pattern Write Functions

The following section introduces the functions which enhance the convenience of pattern writing.

1. Erasing Patterns

The procedure below allows you to erase patterns (or Tracks) which have already been stored in the unit.

- (1) Press [PTN] while holding down [SHIFT ERASE] and confirm that "PATTERN" has been displayed.
- (2) With play stopped, select the pattern (number) to be erased using the TEMPO/DATA knob.

** Preset patterns (000-199) cannot be erased.*
- (3) Press [DELETE] while holding down [SHIFT ERASE] and confirm that "PtnClr" has appeared in the display.
- (4) Select the Track to be erased using the TEMPO/DATA knob.

You can select ALL (all Tracks and all Patterns), or DR (Drum Track), or T1, T2, or T3.

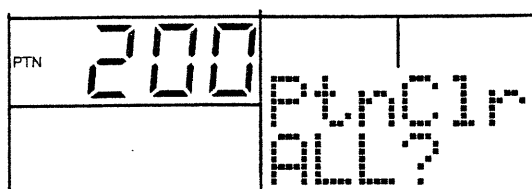

- (5) Press [ENTER].

The message "Sure?" will appear, asking you to confirm that you really want to erase an existing pattern.

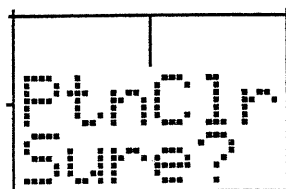

- (6) To go ahead and erase it, press [ENTER].
To cancel the procedure, press [EXIT].

2. Copying Patterns

The performance data in one pattern can be copied into another pattern (number).

This function can be conveniently used when you intend to quickly create a new pattern that is similar to an existing one, and you intend to simply make some modifications in the copied version.

You can copy only one track of a pattern into one track of another pattern.

(1) Press [PTN] while holding down [SHIFT ERASE] and confirm that "PATTERN" has been displayed.

(2) With play stopped, select the Pattern (number) at the copy source using the TEMPO/DATA knob.

(3) Press [COPY] while holding down [SHIFT ERASE].

"Copy?" will be displayed.

(4) Select the Pattern (number) at the copy destination using the TEMPO/DATA knob.

If you wish to copy a specific track, change the display using [>], and then select the source and the destination.

* You cannot specify a Preset pattern as the copy destination.

* When you select "AL" or "DR" as the copy source, the destination will also be "AL" or "DR."

(5) To execute with making the copy, press [ENTER]. To cancel the procedure, press [EXIT].

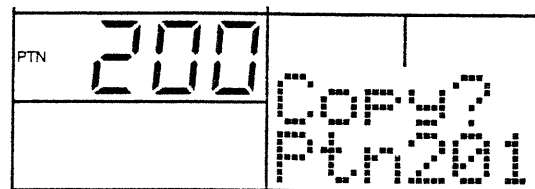

(When selecting a Pattern)

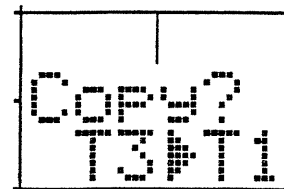

(When selecting a Track)

If there already is a pattern at the copy destination, the "OvrWR?" message will appear, asking you if it is all right to overwrite (replace) the existing pattern.

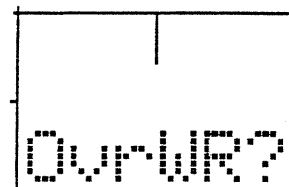

To continue and make the copy, press [ENTER].

To cancel the procedure, press [EXIT].

* "PtnEmp" will be displayed when the pattern specified as the copy source is empty.

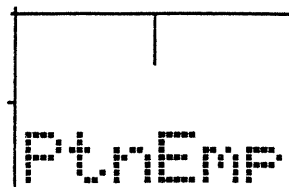

3. Pattern Transpose

This feature allows you to transpose the pitch of melodies (Instruments) recorded in a pattern by up to an octave in either direction. (TRACKs 1 to 3 only)

Pattern Transpose directly rewrites the pitch information contained in the pattern.

** Preset patterns cannot be transposed.*

- (1) Select the Pattern mode.
Press [PTN] while holding down [SHIFT ERASE] and confirm that "PATTERN" has been displayed.
- (2) Select the pattern (number) that is to be transposed using the TEMPO/DATA knob.
- (3) Press [TRANS] while holding down [SHIFT ERASE], and "Trans?" will appear in the display.
- (4) Select the Track that is to be transposed.
Using the TEMPO/DATA knob, select a Track from T1 to T3.
- (5) Using [<]/[>], move the cursor to the transposition pitch.
- (6) Specify the pitch by which to transpose using the TEMPO/DATA knob. (-12 to +12)

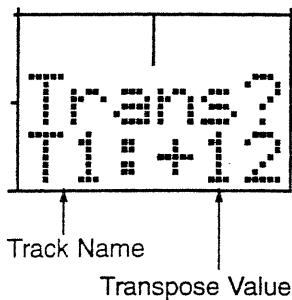

- (7) Press [ENTER].
The message "Sure?" is displayed, asking you to confirm that you want to change the pitch.
- (8) To carry out the transposition, press [ENTER].
To cancel the procedure, press [EXIT].

** When the pattern is empty, "PtnEmp" will be displayed.*

** You cannot transpose the pitch of a Pattern beyond the storage limits of a Pattern location. If you attempt to do so, the Pitch value will automatically be set the maximum value possible within a Pattern location.*

4. Swing

The Swing feature allows you to create a 'swing' feel; a rhythmic feel used in big band and jazz music.

The following two settings are made for Swing:

Swing Point

The Swing effect causes notes that were input at a specific beat within the pattern to be sounded slightly later. The beat at which you want this delay to be applied is known as the "Swing Point."

When Swing Point is eighth note.



Swing Delay

The Swing Delay is the amount by which the sound is to be delayed. The greater you set the value, the greater the delay, and the more pronounced the Swing effect.

When Swing Point is "♪".

Notes which are delayed.

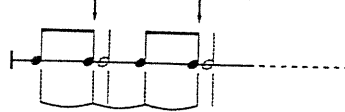

- (1) Select the Pattern mode.
Press [PTN] while holding down [SHIFT ERASE] and confirm that "PATTERN" has been displayed.
- (2) Select the pattern (number) to which Swing is to be applied using the TEMPO/DATA knob.
- (3) Switch the page using [<]/[>]. Confirm that "Swing" has been displayed.
- (4) Specify the timing of the beat that is to have the Swing effect using the TEMPO/DATA knob.

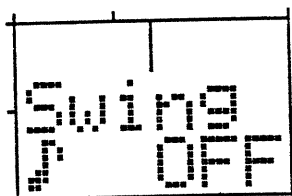

Timing which can be set Swing.

♪	Eighth Note
♪	Sixteenth Note

- (5) Move the cursor to the location of the number using [<]/[>]. Set the Swing Delay using the TEMPO/DATA knob.

Amount of Swing.

♪	OFF, 1 — 23
♪	OFF, 1 — 11

* When set to "OFF," the Swing effect will not be applied.

5. Timing Shift

Allows the timing of events displayed while in Step edit to be shifted.

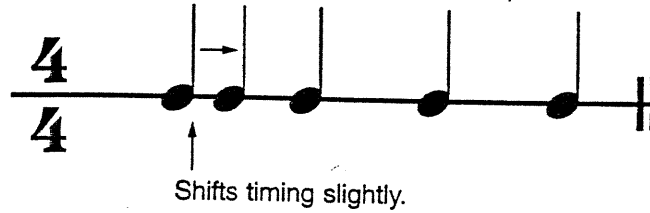

- (1) Press [TIME SHIFT] while holding down [SHIFT ERASE] when in the Step Edit mode.
- (2) Specify the amount by which the timing is to be shifted using the TEMPO/DATA knob. (-7 to +7)

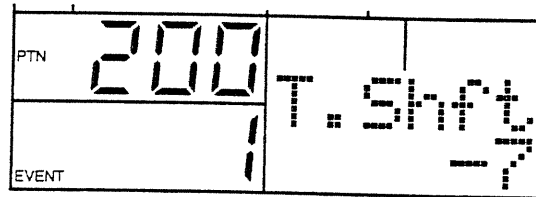

- (3) Press [ENTER].

If you make a setting which exceeds the possible range, "OutRng" is displayed and the timing cannot be shifted.

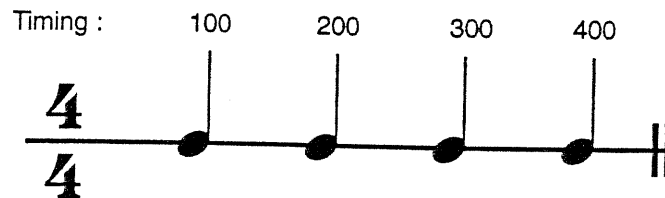

This Event cannot be shifted to previous timing (-1 — -7).
When you try to execute the Timing Shift, "OvrRng" will be displayed.

- * If there is an identical instrument (Drum Track) or an identical pitch (Tracks 1-3) at the place where the timing is being moved, the message "OvrWR?" appears in the display, asking you to confirm that you wish to overwrite (replace) the existing data.
To go ahead and carry out the procedure, press [ENTER].
To cancel it, press [EXIT].

6. Altering Settings for the Metronome

Carry out the procedure below to make settings for the volume and beat of the metronome, which sounds when using Realtime Write.

- (1) Select the Utility mode.
Press [UTIL] while holding down [SHIFT ERASE] and confirm that "UTILITY" has been displayed.
- (2) Switch the page using [<]/>]. Confirm that "Click" has appeared in the display.
- (3) Set how to sound the metronome using the TEMPO/DATA knob.

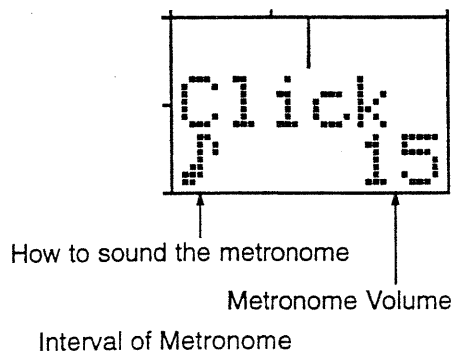

♪	Quarter note	♪	Eighth note
♪ ₃	Quarter note triplet	♪ ₃	Eighth note triplet

- (4) Move the cursor to the position of the number using [<]/>]. Set the volume using the TEMPO/DATA knob (OFF/1 to 15).

(3) Practicing a Pattern Write

As practice in writing a pattern, try inputting the rhythmic pattern below.

Em7

Chord

Bass

Drums

← Hi-hat
← Stick
← Kick

Start with the Drums. Use Step Write to input the pattern.

1. Inputting the Drum Pattern (Step Write)

- (1) First, set the unit to the initial settings for Pattern Write (p. 3-4).

Select the pattern number of the pattern you are going to create, and enter a name for it. Set the beat to 4/4.

PTN	200	PtnNam Latin
TEMPO	120	

- (2) Press [REAL/STEP] to enter recording standby for Step Write.

Set Quantize to an eighth note using the TEMPO/DATA knob.

PTN	200	QUANTIZE	TIMING
EVENT	-		100

- (3) Press [TRACK SEL] to select the DRUM track.

After pressing [KIT], use the TEMPO/DATA knob to select Preset Kit No. 38 (P38: Perc). Once selected, press [KIT] again.

- (4) Press [START] to start the Step Write process.

Go ahead and input the Instrument.

<For Stick>

(Stick-1) Press [FWD] to advance to beat number 2. Then input the sound by tapping the pad that has the Stick sound assigned to it.

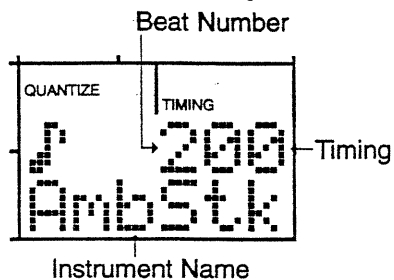

(Stick-2) Press [FWD] again to advance to beat number 4, timing: 00. Once again tap the pad to input the sound.

<For Kick>

(Kick-1) Tap the pad to which the kick sound is assigned.

(Kick-2) Press [FWD], and advance to beat number 2, timing: 24. Then tap the pad.

(Kick-3) Press [FWD] again to advance to beat number 3, and tap the pad.

(Kick-4) Again press [FWD], and advance to beat number 4, timing: 24. Tap the pad.

<For Hi-Hat>

(Hi-Hat-1) Input the Instrument by tapping the pad that has the Hi-hat sound assigned to it. Then, press [FWD] to advance to the next timing. Repeat this until you have input all eight of the eighth notes.

(5) Press [STOP] to finish entering the rhythm.

Now, you can go on and input the Bass part using Realtime write. (If you find that doing it in real-time is too difficult, you can use Step Write instead.)

3. Inputting the Chord Backing (Using Step/Chord Input Features)

- (1) Press [REAL/STEP] to enter recording standby for Step Write.
Set Quantize to an eighth note (p. 3-4).
- (2) Press [TRACK SEL] to select Track 1.
- (3) Press [KIT], then use the TEMPO/DATA knob to select the Kit. Once selected, press [KIT] again.
- (4) Press CHORD [ON/OFF] to enter the Chord Input mode.
- (5) Press [START].
- (6) Input the chords.

To input the Em7 chord, hold down the (E) in the lower-left corner of the key pads while you press the second key pad from the left on the second row from the top (m7).

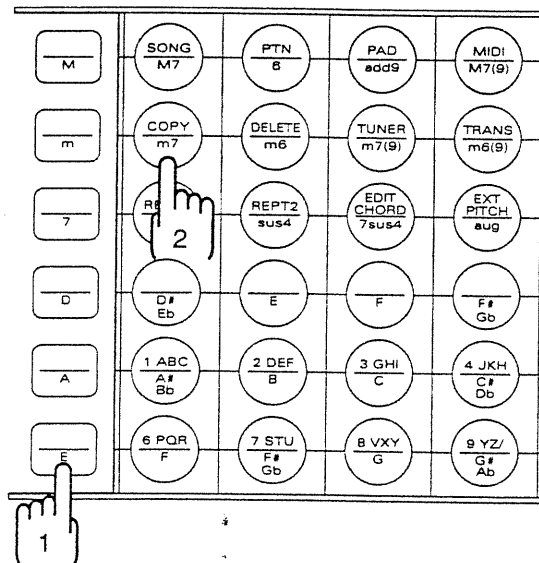

- (7) Press [FWD] to advance to beat number 2. Then input the second chord, the same as in step (4). Then press [TIE] once while holding down the Key Pad. This way, it will be tied with the note input in step (6), forming a quarter note.
- (8) Press [FWD], and advance to beat number 3, timing: 24. Then input the Em7 chord the same way as you did in (6). Next, the same as was done in (7), tie it with the eighth note at the fourth beat.
- (9) Press [STOP] to finish writing the pattern.

When you feel difficulty in (7) and (8), you may change the Quantize to the fourth note.

2. Inputting the Bass Pattern (Realtime Write)

- (1) Press [REAL/STEP] to enter recording standby for Realtime Write.
Set Quantize to an eighth note (p. 3-4).
- (2) Press [TRACK SEL] to select Track 2.
- (3) Press [KIT], then use the TEMPO/DATA knob to select the Kit. With it selected, press [KIT] again.
- (4) Press [TEMPO] to adjust it so the unit is using a tempo that makes it easy for you to input the pattern. Press [TEMPO] again when finished (to go back to the Realtime Write mode).
- (5) Press [START] to start the Realtime Write process.

While listening to the metronome, tap the pad in accord with the printed music to input the pattern.

Bass



The diagram shows a bass staff with a treble clef and a 2/4 time signature. The notes are: G2 (quarter), G2 (quarter), A2 (quarter), A2 (quarter), B2 (quarter), B2 (quarter). Below the staff is a fretboard diagram with three frets. The first fret is marked with a vertical line. Below the fretboard are three buttons: a square button with a horizontal line, a circular button with a vertical line, and another square button with a horizontal line. The circular button is highlighted with a circle.

Interval button is down

Button that is pressed

(Fret=1)

- (6) Press [STOP] to finish entering the pattern.

You can now go ahead and finish the pattern by entering the chords.

Chapter 4

Creating Songs

Songs are created by linking together patterns in the order you want them to play. Once created, a Song can be enhanced by adding repeat symbols and transposing some of its patterns or adjusting the Track Level. You can also set the volume level for each track.

The patterns, repeat symbols, transposition and track level information are each placed within a structure known as a Part. A Part Number is assigned to every Part, starting from the beginning of the Song.

Repeat

Allows a specified range of patterns to be repeated.

Transpose

Allows you to transpose the melodies and chords (pitch of Instruments) of patterns which occur after a specified point. The amount of transposition is set in semitone units, up to a maximum of one octave in either direction.

*** Unlike transpositions which are applied to patterns (p. 3-14), when you transpose a song, the data contained within the patterns is not altered in any way. For that reason, even Preset patterns contained in the song can be transposed.**

Track Level

Allows you to set the volume level individually for the Tracks, for patterns located after the specified place.

(1) The Song Write Procedure

There are two methods for carrying out a Song Write:

Realtime Write

In this method, patterns are stored in the Song in the same order as the patterns are played. This allows you to quickly and easily create songs by using the number buttons to specify the pattern numbers, or by using Specified Pattern Change (p. 5-7).

Step Write

In this method, the order in which patterns are to be linked together is specified using the number buttons. The advantage of Step Write over Realtime is that you can reliably create songs that use a very complex arrangement of patterns.

1. Initial Settings for Song Write

Before beginning a Song Write, the unit needs to be set to the initial settings common to both Real-time Write and Step Write. The parameters that need to be set are as follows:

Song Chain

Song Chain is a feature which allows you to have a multiple number of songs play consecutively. To make the setting, specify the number of the song that should play next.

** If you do not intend to use Song Chains, you do not need to make any settings for it.*

For a detailed explanation, see Chapter 5, "[1] 2. Song Chain" (p. 5-3).

Initial Tempo (OFF/40 to 250 bpm)

This setting allows you to individually specify the tempo that is to be used when each of the songs is played. Once you make the Initial Tempo setting, play will start at this Initial Tempo, regardless of the existing tempo setting. When set to OFF, the song is played using the existing tempo setting.

Song name

Each Song can be given a name that consists of up to 6 characters. The Song Name is displayed when selecting songs (Song Select).

(Making the Settings)

- (1) Get into the Song mode.
Press [SONG] while holding down [SHIFT ERASE] and confirm that "SONG" has been displayed.
- (2) Specify the Song for which you wish to make settings (No. 0-19) using the TEMPO/DATA knob.

** You cannot use Song 20 (Demo Song).*

Song Chain Settings

- (3) Select the page where settings can be made for Song Chain.
Switch the page using [`<`]/[`>`] and confirm that "Chain" has appeared in the display.

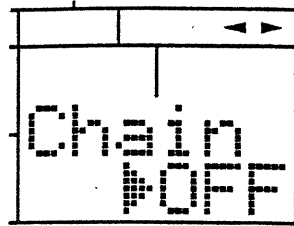

- (4) Select the Song that is to be played next using the TEMPO/DATA knob. (OFF/0-19)

* When set to OFF, the following song will not be played. (Once the current song finishes, play stops automatically.)

Settings for Initial Tempo

- (3) Select the page where settings can be made for Initial Tempo.
Switch the page using [`<`]/[`>`] and confirm that "I.Tmp" is shown in the display.

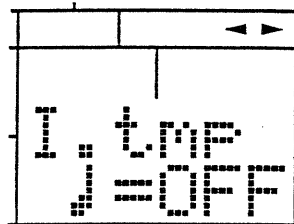

- (4) Make settings for the Initial Tempo using the TEMPO/DATA knob. (OFF/40-250)

Naming the Song

- (3) Select the page where settings can be made for the Song name.
Switch the page using [`<`]/[`>`] and confirm that "SngNam" is shown in the display.

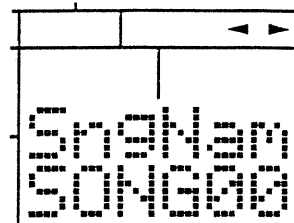

- (4) While holding down [SHIFT ERASE], input a Song Name using the number/letter/symbol buttons.
Use [`<`]/[`>`] to move the cursor within the string of characters.

2. Realtime Write

After setting the unit to the initial settings for Song Write (p. 4-2), carry out the following:

- (1) Press [REAL/STEP] to enter recording standby for Realtime Write.
- (2) Select the pattern to be input into the first measure using the TEMPO/DATA knob.
- (3) Press [START].
The currently selected pattern starts playing.
- (4) Select the pattern (number) to be input into the next measure (Part) using the TEMPO/DATA knob.
- (5) By repeating step (4), select all the patterns that you wish to place into the song.

SONG	00	PART	MEAS
TEMPO	120	001001	Ptn200

The number of repetitions of a pattern that will be stored as part of the song will be the same as the number of times the pattern was actually played during input. So, for example, if you want to have Pattern A play for 3 measures, then have Pattern B play in the 4th measure, you would need to select Pattern B after Pattern A has entered its third repetition (before the end of the 3rd measure).

You will probably find that it is best to write down your plans for the song beforehand, and have this sheet handy before beginning the Realtime Write process.

- (6) Press [STOP] when you are finished with the Realtime Write.

- * *Realtime Write cannot be carried out for a Song (number) that already contains patterns (Erasing Songs: p. 4-7).*
- * *Realtime Write will stop automatically when the number of Parts in the song reaches 250.*

3. Step Write

After setting the unit to the initial settings for Song Write (p. 4-2), carry out the following:

- (1) From the Song mode press [REAL/STEP] to enter recording standby for Step Write.
- (2) Select the pattern to enter into the Part using the TEMPO/DATA knob.

TRACK SELECT	DRUM	REC	ENTER ◀
SONG		PART	
00		001?	
TEMPO		PTN200	
120			

- (3) Press [ENTER] to enter it.
You are advanced to the next Part.
- (4) Complete the Song by repeating steps (2) through (3).
- (5) Should you mistakenly input the wrong pattern, use [BWD] to select that Part, then reselect the pattern.

* When "?" is displayed, it means that the data displayed has not yet been input into a Part. Press [ENTER] and input it.

The relationship between Part and Patterns is as follows:

Part Number :	1	2	3	-----
	Pattern 1	Pattern 2	Pattern 3	-----
Measure :	1	2	3	-----

Songs containing transpositions and repeats are as follows:

Part Number :	1	2	3	-----
	:	Pattern 1	Pattern 2	: Transpose +12
Measure :		1	2	-----
		(2nd) 3	4	-----

Settings for transpose, repeat and track level should be made in step (2).

Move the cursor to the "PTN" position using [<|>], and input the transpose (TRN) the repeat (||: , :||) or the track level ("DR," "T1," "T2," "T3").

When necessary, use [<|>] to move the cursor to the number position, then use the TEMPO/DATA knob to specify the pitch (number of semitones to shift it), the number of times to repeat it, and the level of the track.

Input Example 1

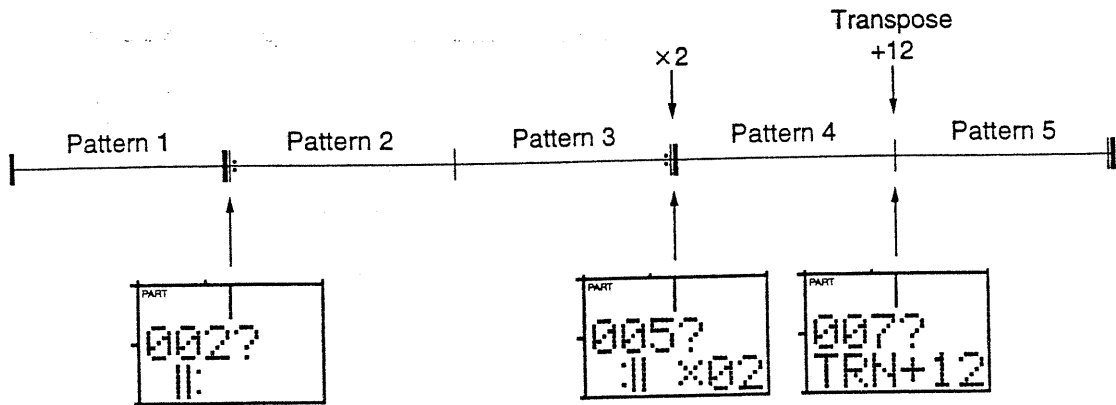

Input Example 2

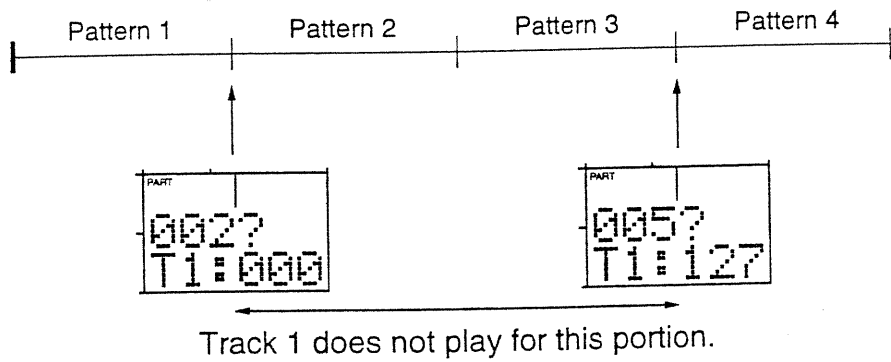

* Any Track for which Track Level is set to "0" will be silent.

* The value of the MIDI Expression switch (p. 9-10) will be the same value as that set for the Track Level. However, the Track Level setting will be ignored whenever the MIDI Expression switch is set to "OFF" (no change in the volume is obtained).

(2) Functions Convenient for Song Write

The following section introduces several functions which make song writing easier:

1. Erasing Song Data (Song Clear)

The following procedure allows you to erase performance data at the selected Song Number.

- (1) Get into the Song mode.
Press [SONG] while holding down [SHIFT ERASE] and confirm that "SONG" has been displayed.
- (2) With play stopped, select the Song (No. 0-19) to be erased using the TEMPO/DATA knob.
- (3) Press [DELETE] while holding down [SHIFT ERASE].
"Song Clear?" will be shown in the display.

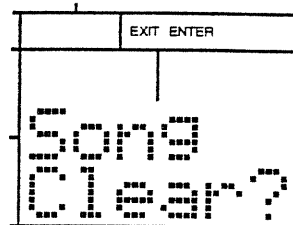

- (4) Press [ENTER].
The message "Sure?" appears, asking you to confirm your choice.
- (5) To proceed with the erasure, press [ENTER].
To cancel it, press [EXIT].

2. Copying Song Data (Song Copy)

This function allows the performance data in one Song (including the song name) to be copied into another Song.

This function can be conveniently used when you intend to quickly create a new Song that is similar to an existing one, since you only need to make some modifications in the copied version.

- (1) Get into the Song mode.
Press [SONG] while holding down [SHIFT ERASE] and confirm that "SONG" has been displayed.
- (2) With play stopped, select the Song (number) at the copy source using the TEMPO/DATA knob.
- (3) Press [COPY] while holding down [SHIFT ERASE].
"Copy?" and the Song Number at the copy destination are shown in the display.
- (4) Specify the Song Number at the copy destination using the TEMPO/DATA knob.

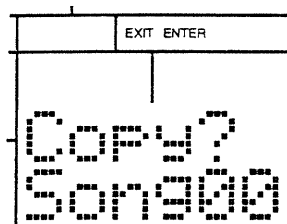

- (5) To proceed with the copy, press [ENTER]. To cancel the procedure, press [EXIT].

When there is already data for a Song at the copy destination, the message "OvrWR?" will appear, asking you if it is all right to overwrite (replace) the existing Song. To go ahead and make the copy, press [ENTER]. To cancel it press [EXIT].

When there is no data in the Song specified as the copy source, "SngEmp" will be displayed.

3. Erasing Parts (Part Delete)

This procedure is used to erase Parts that were written into a Song.

- (1) Get into the Song mode.
Press [SONG] while holding down [SHIFT ERASE] and confirm that "SONG" has been displayed.
- (2) Press [REAL/STEP] to switch to recording standby for Step Write.
- (3) Specify the Part (number) which you wish to erase using [FWD]/[BWD].
- (4) Press [DELETE] while holding down [SHIFT ERASE].
"Del?" will be displayed.

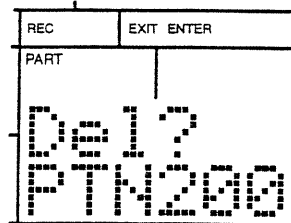

- (5) Press [ENTER]. The message "Sure?" is displayed.
- (6) To go ahead and erase it, press [ENTER]. To cancel the procedure, press [EXIT].

When there is no data, "NoPart" will be displayed for the specified Part.

4. Inserting Parts (Part Insert)

Carry out the procedure below to insert new Parts into a Song.

You will need to insert new Parts at times such as when you have added repeated portions and transpositions after the Song was completed.

Inserts Pattern X to Part 003.

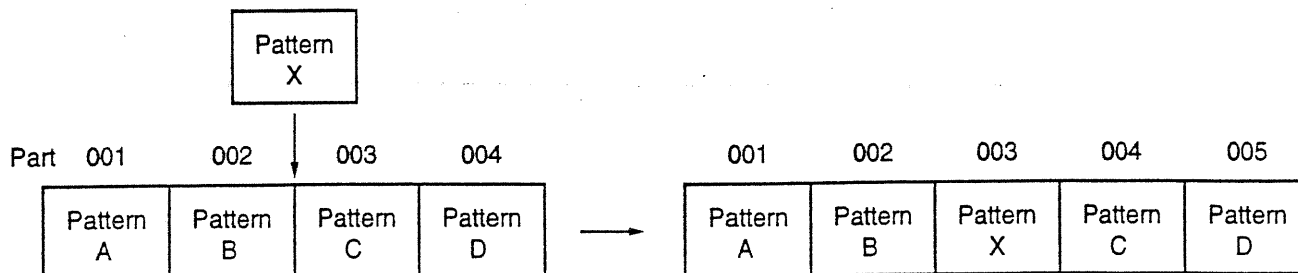

- (1) Get into the Song mode.
Press [SONG] while holding down [SHIFT ERASE] and confirm that "SONG" has been displayed.
- (2) Press [REAL/STEP] to switch to recording standby for Step Write.
- (3) Specify the Part (number) into which a new pattern is to be inserted using [FWD]/[BWD].
- (4) Press [COPY] while holding down [SHIFT ERASE].
- (5) Specify the pattern (number) which is to be inserted using the TEMPO/DATA knob.

Repeats, transpositions and track levels can also be inserted instead of patterns. (The input method is the same as that for Step Write: p. 4-6.)

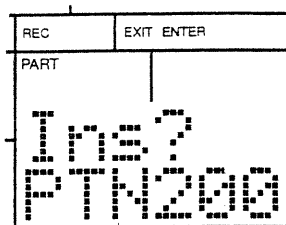

- (6) Press [ENTER]. The message "Sure?" is displayed.
- (7) To carry out the insertion, press [ENTER].
To cancel the procedure, press [EXIT].

Chapter 5

Playing Songs and Patterns

(1) Song Play

Perform the following (while play is stopped) to play Songs created using Song Write.

- (1) Press [SONG] (the key pad in the upper-left corner) while holding down [SHIFT ERASE] and confirm that "SONG" has been displayed. (Song play)

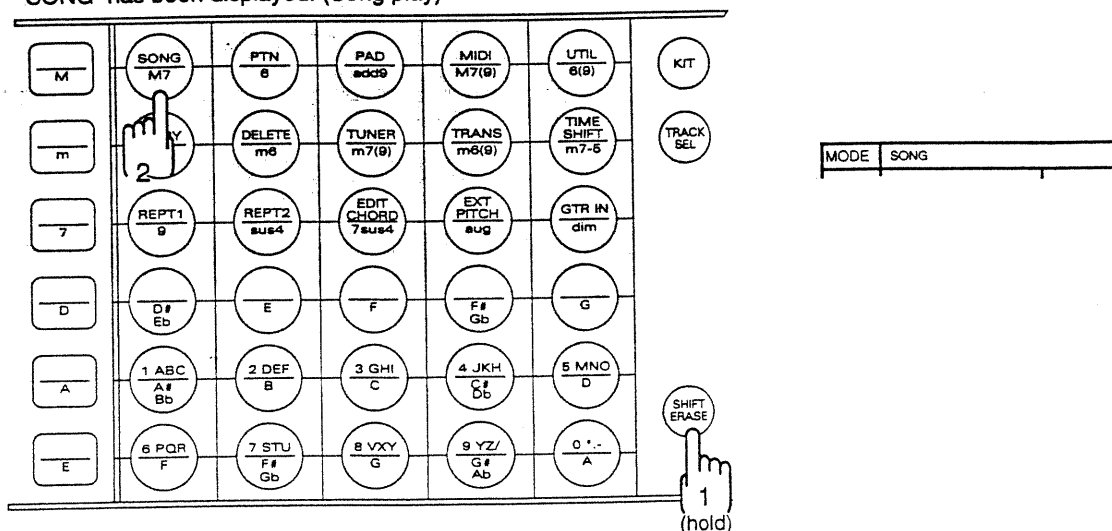

- (2) Select the Song to be played (No. 0-19) using the TEMPO/DATA knob. The first Part number and the Song name are shown in the display.

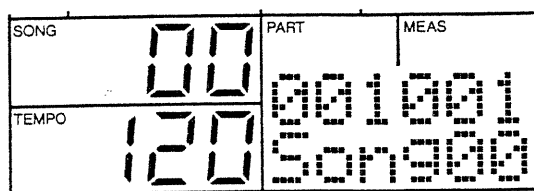

- (3) Press [START] to have play begin. The measure number and the pattern number currently being performed are shown in the display.

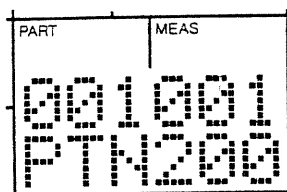

* The Song which doesn't contain data cannot start to play.

- (4) When you press [STOP], play is stopped. When you press [START], play starts once again from the place that it was stopped.

1. Continue Play

Performance starts from the specified measure. This is convenient to use when you want to have play start from midway through a Song.

Carry out the following procedure while Song Play is stopped.

- (1) Specify the measure from which to start play using [FWD]/[BWD].
- (2) When you press [START], play starts from the specified measure.

2. Song Chain

Song Chain is a feature which allows you to have a multiple number of songs play consecutively.

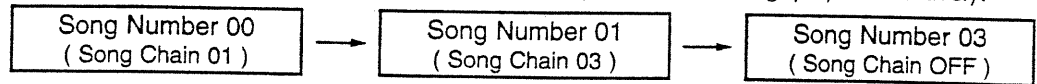

Making Settings

- (1) Get into the Song Play mode.

Press [SONG] (the first key at the upper-left) while holding down [SHIFT ERASE], and confirm that "SONG" has been displayed.

- (2) Switch the page using [<|>]. Confirm that "Chain" has appeared in the display.
- (3) Use the TEMPO/DATA knob to select the number of the Song to be played next. (OFF/0 to 19)

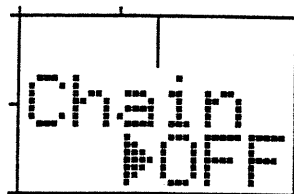

3. Section Repeat

This feature allows you to have the same section of a Song play repeatedly.

Song

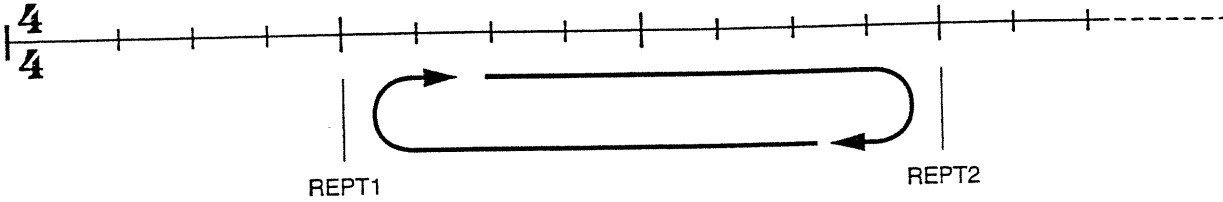

Making the Setting for a Repeat

- (1) With Song play stopped, press [REPEAT].

The Repeat function is now ON.

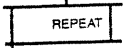

- (2) Press [RESET] and then press [START] to start the Song.

Repeat can be turned ON/OFF at any time. If turned ON during play, however, play will continue normally.

How to Set the Repeat Point

[To set it during play of a Song]

- (1) Select the Song Play mode.
Press [SONG] (the first key at the upper-left) while holding down [SHIFT ERASE], and confirm that "SONG" has been displayed.
- (2) Press [START].
- (3) When you arrive at the first measure in the section that you want to have repeated, hold down [SHIFT ERASE] while you press [REPT1] (the third button from the top in the column farthest left).

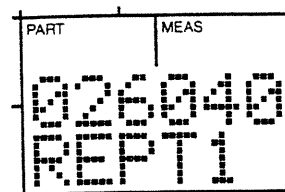
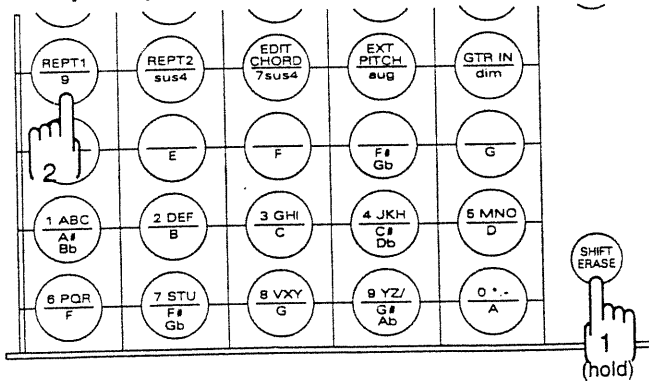

* A message appears momentarily when the button is pressed.

- (4) When you arrive at the last measure in the section that you want to have repeated, hold down [SHIFT ERASE] while you press [REPT2] (the third button from the top in the column second from the left).

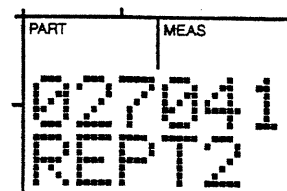
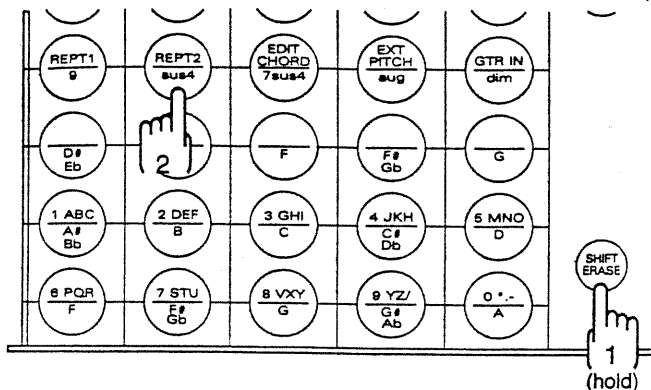

- (5) Press [STOP] to stop the Song.
- (6) Press [REPEAT] to turn Section Repeat ON/OFF.
 "REPEAT" will be displayed when ON. (It is switched ON or OFF with each press of the button.)

[Making the Setting While the Song is Stopped:]

- (1) Select the Song Play mode.
Press [SONG] (the first key at the upper-left) while holding down [SHIFT ERASE], and confirm that "SONG" has been displayed.
- (2) Select the first measure in the section that you want to have repeated using [FWD]/[BWD].
- (3) Hold down [SHIFT ERASE] while you press [REPT1] (the third button from the top in the column farthest left).
- (4) Select the last measure in the section that you want to have repeated using [FWD].
- (5) Hold down [SHIFT ERASE] while you press [REPT2] (the third button from the top in the column second from the left).
- (6) Press [REPEAT] to turn Section Repeat ON/OFF.
"REPEAT" will be displayed when ON. (It is switched ON or OFF with each press of the button.)

- * *In both methods, always specify a measure for REPT1 which occurs earlier than that for REPT2. They cannot be specified in reverse.*
- * *The Repeat Points you set here are only temporary. If you select another Song, or turn power off then on again, the settings for the Repeat region will no longer be valid.*

(2) Specified Pattern Changes

This feature allows you to instantaneously switch, during play, to some other pattern that has been set beforehand for Specified Pattern Change. Since you can easily switch patterns, the DR-5 can be used for backing while you perform on some other Instrument.

1. Overview

Patterns are organized and handled as follows when using the Specified Pattern Change function.

Original Patterns

The basic type of pattern.

Variation Patterns

These patterns are switched to from an Original pattern. You will probably want to assign patterns which are altered forms of the Original patterns. (Variations of basic patterns.)

Fill-In to Variation Patterns

These patterns are used as fills when switching from an Original pattern to a Variation pattern.

Fill-In to Original Patterns

These patterns are used as fills when switching from a Variation pattern to an Original pattern.

2. Making the Settings

- (1) Select the Pattern mode.

Press [PTN] (the button at the top in the column second from the left) while holding down [SHIFT ERASE], and confirm that "PATTERN" has been displayed.

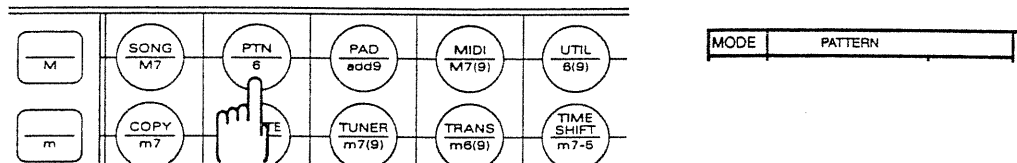

- (2) Specify the Pattern Number for which you wish to make settings for Specified Pattern Change using the TEMPO/DATA knob.
- (3) Select the page where settings can be made for Variation Assign.
Press [<|/>] to switch the page and confirm that "VAR" and a pattern number have appeared in the display.

- (4) Select the pattern (number) to be used as a Variation pattern using the TEMPO/DATA knob.

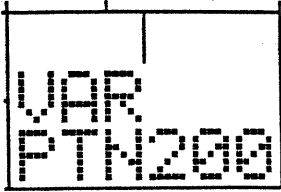

- (5) Select the page where settings can be made for Fill-In To Variation Assign.
Press [←]/[→] to switch the page and confirm that "FTV" and a pattern number have appeared in the display.
- (6) Select the pattern (number) to be used as a Fill-In To Variation pattern using the TEMPO/DATA knob for a Fill-In to Variation pattern.

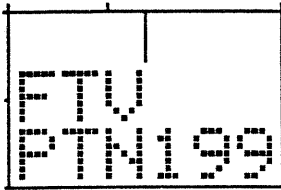

- (7) Select the page where settings can be made for Fill-In to Original Assign.
Press [←]/[→] to switch the page and confirm that "FTO" and a pattern number have appeared in the display.
- (8) Select the pattern (number) to be used as a Fill-In to Original pattern using the TEMPO/DATA knob.

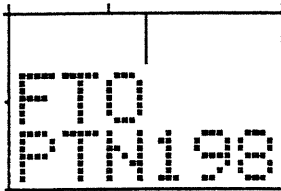

- (9) Select the page which is used to switch the Specified Pattern Change function ON/OFF.
Press [←]/[→] to switch the page and confirm that "SPC SW" has appeared in the display.
- (10) Use the TEMPO/DATA knob to choose whether it is to be ON or OFF.

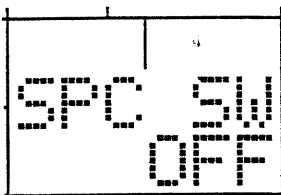

* When set to "OFF" settings, the Specified Pattern Change Function will not operate.

3. Procedure

- (1) Press [PTN] (the button at the top in the column second from the left) while holding down [SHIFT ERASE], and confirm that "PATTERN" has been displayed.

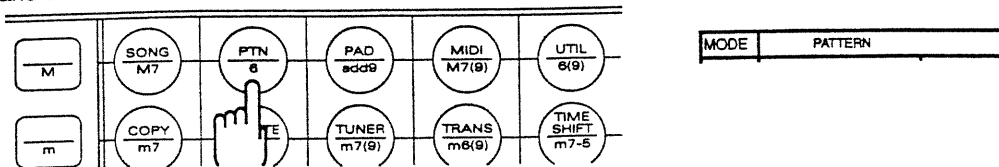

You can use Specified Pattern Change feature when Realtime Song Write (p. 4-4).

- (2) Select a pattern to be played using the TEMPO/DATA knob.
 (3) Press [START] to start play of the pattern.

Press [START] during play of a pattern, and the unit will switch to the Variation pattern after the current pattern.

Press [FWD] during play of a pattern, and the unit will start playing the Fill-In To Variation pattern after the current pattern. Afterwards, it will switch to the Variation pattern.

When you press [BWD] during play of a pattern, the unit will start playing the Fill-In to Original pattern after the current pattern. Afterwards, it will switch to the pattern selected in step (2) above.

If you press [STOP] during play of a Variation pattern or a Fill-In pattern, play will stop. You can then press [RESET], and the unit will return to the beginning of the pattern selected in step (2) above.

(Ex.) In 4/4 time:

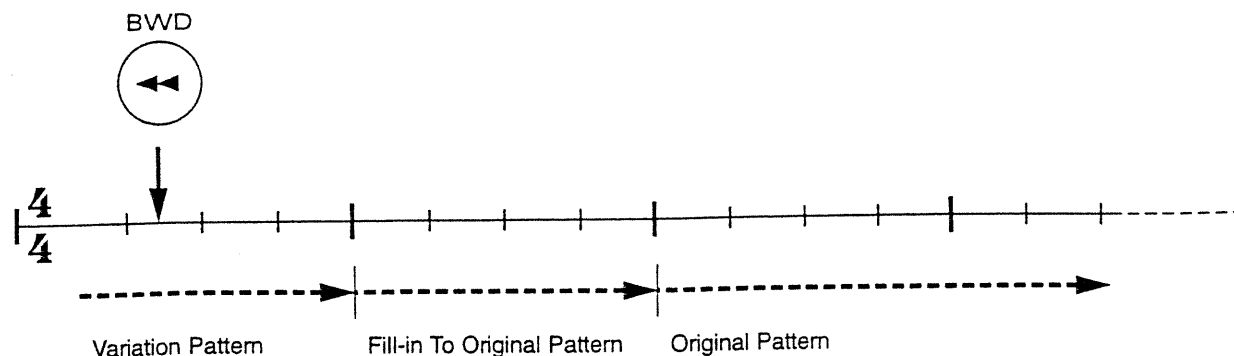
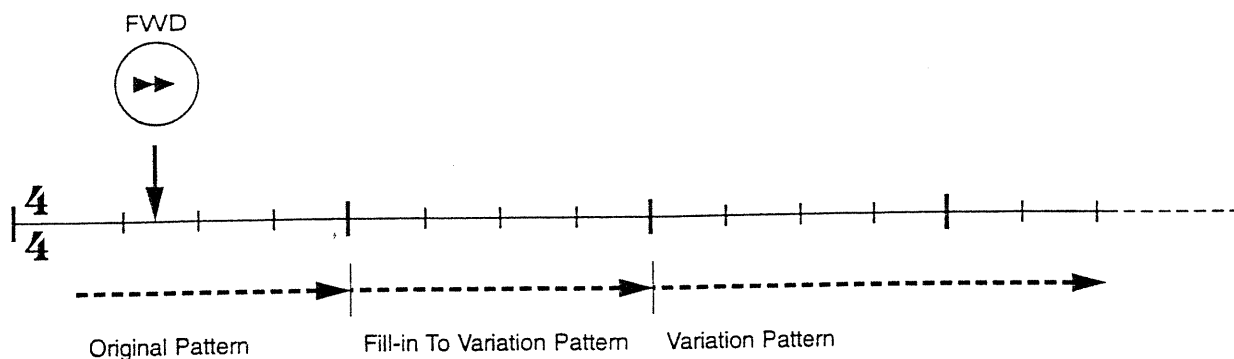

Chapter 6

Changing Key Pad Sound Assignments

(1) Editing the Sound of Instruments

The Instrument assigned to each key pad can be edited to your liking.

Editing that is done to Instruments is effective on an individual Kit basis. So even if you are using the same selection of Instruments in two Kits, you can edit the sounds in one of the Kits so the two Kits sound differently. This is possible because the unit allows editing changes to be stored as belonging only to a particular Kit.

1. About the Sound Parameters

The parameters used for editing sounds are as shown below.

*** Individual settings for each key pad for Decay, Pan, and Volume cannot be made for TRACKs 1 to 3.**

Inst: Instrument Assign

On the DR-5, any Instrument you like can be assigned to any key pad. You can also assign a single Instrument to several key pads.

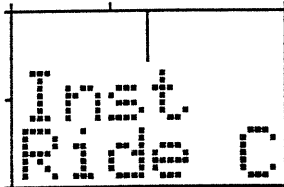

The DR-5 contains these 256 Instruments:

No.	Display	Instrument Name	No.	Display	Instrument Name	No.	Display	Instrument Name
0	Piano1	Piano 1	24	Cln Gt	Clean Guitar	48	SynBs1	Synth. Bass 1
1	Piano2	Piano 2	25	Pop Gt	Pop Guitar	49	SynBs2	Synth. Bass 2
2	Honky	Honky-tonk	26	MutGt1	Muted Guitar 1	50	SynBs3	Synth. Bass 3
3	EPian1	E. Piano 1	27	MutGt2	Muted Guitar 2	51	SynBs4	Synth. Bass 4
4	EPian2	E. Piano 2	28	FnkGt1	Funk Guitar 1	52	SynBs5	Synth. Bass 5
5	Clav	Clav.	29	FnkGt2	Funk Guitar 2	53	Violin	Violin
6	Vibe	Vibraphone	30	OvrGt1	Overdrive Guitar 1	54	Contra	Contrabass
7	Marimb	Marimba	31	OvrGt2	Overdrive Guitar 2	55	Pizz	Pizzicato Strings
8	Organ1	Organ 1	32	HevyGt	Heavy Guitar	56	Timpan	Timpani
9	Organ2	Organ 2	33	DistGt	Distortion Guitar	57	Strin1	Strings 1
10	Organ3	Organ 3	34	FdbkGt	Feedback Guitar	58	Strin2	Strings 2
11	Organ4	Organ 4	35	HarmGt	Harmonics Guitar	59	Choir	Choir
12	Accord	Accordion	36	Feedbk	Feedback	60	Orches	Orchestra Hit
13	Harmo	Harmonica	37	AcoBs1	Acoustic Bass 1	61	Trumpt	Trumpet
14	NylGt1	Nylon String Guitar 1	38	AcoBs2	Acoustic Bass 2	62	MuteTp	Mute Trumpet
15	NylGt2	Nylon String Guitar 2	39	FngBs1	Fingered Bass 1	63	Brass1	Brass 1
16	StlGt1	Steel String Guitar 1	40	FngBs2	Fingered Bass 2	64	Brass2	Brass 2
17	StlGt2	Steel String Guitar 2	41	PickBs	Picked Bass 1	65	Brass3	Brass 3
18	12 Gt1	12 String Guitar 1	42	FretBs	Fretless Bass	66	SopSax	Soprano Sax
19	12 Gt2	12 String Guitar 2	43	SlpBs1	Slap Bass 1	67	TenSax	Tenor Sax
20	Ukulele	Ukulele	44	SlpBs2	Slap Bass 2	68	Oboe	Oboe
21	Mandol	Mandolin	45	SlpBs3	Slap Bass 3	69	Clarin	Clarinet
22	JazzGt	Jazz Guitar	46	SlpBs4	Slap Bass 4	70	Flute	Flute
23	HawaGt	Hawaiian Guitar	47	SlpBs5	Slap Bass 5	71	Square	Square Wave

No.	Display	Instrument Name	No.	Display	Instrument Name	No.	Display	Instrument Name
72	Sine	Sine Wave	122	DopinS	Dopin' Snare	172	Rim T1	Rim Tom 1
73	Saw	Saw Wave	123	DoublS	Double Snare	173	Rim T2	Rim Tom 2
74	Saw5th	5th Saw Wave	124	Elec S	Electronic Snare	174	Rim T3	Rim Tom 3
75	Fantas	Fantasia	125	Fat S	Fat Snare	175	Rim T4	Rim Tom 4
76	Warm	Warm Pad	126	Grab S	Grab Snare	176	RockT1	Rock Tom 1
77	Poly	Poly Synth.	127	HouseS	House Snare	177	RockT2	Rock Tom 2
78	Sound	Soundtrack	128	HsDpnS	House Dopin' Snare	178	RockT3	Rock Tom 3
79	Sitar	Sitar	129	KettlS	Kettle Snare	179	RockT4	Rock Tom 4
80	Banjo	Banjo	130	LA S	L.A. Snare	180	808 T1	TR-808 Tom 1
81	StlDr	Steel Drum	131	LooseS	Loose Snare	181	808 T2	TR-808 Tom 2
82	Ambo K	Ambient Kick	132	MapleS	Maple Snare	182	AcoCHH	Acoustic Closed Hi-hat
83	BriteK	Bright Kick	133	NoiseS	Noise Snare	183	AcoOHH	Acoustic Open Hi-hat
84	Cave K	Cave Kick	134	NshvIS	Nashville Snare	184	AcoPHH	Acoustic Pedal Hi-hat
85	Club K	Club Kick	135	Picc S	Piccolo Snare	185	HvyCHH	Heavy Closed Hi-hat
86	DanceK	Dance Kick	136	RadioS	Radio Snare	186	HvyOHH	Heavy Open Hi-hat
87	Dark K	Dark Kick	137	RckRmS	Rock Rim Shot Snare	187	PopCHH	Pop Closed Hi-hat
88	Deep K	Deep Kick	138	RealS1	Real Snare 1	188	PopOHH	Pop Open Hi-hat
89	Dig K	Dig Kick	139	RealS2	Real Snare 2	189	PopPHH	Pop Pedal Hi-hat
90	Dry K	Dry Kick	140	RealS3	Real Snare 3	190	808CHH	TR-808 Closed Hi-hat
91	ElecK1	Electronic Kick 1	141	Regg1S	Reggae Snare 1	191	808OHH	TR-808 Open Hi-hat
92	ElecK2	Electronic Kick 2	142	ReggS2	Reggae Snare 2	192	CrshC1	Crash Cymbal 1
93	Flop K	Flop Kick	143	Ring S	Ring Snare	193	CrshC2	Crash Cymbal 2
94	GateK1	Gate Kick 1	144	RmGt S	Room Gated Snare	194	RidBIC	Ride Bell Cymbal
95	GateK2	Gate Kick 2	145	Rock S	Rock Snare	195	Ride C	Ride Cymbal
96	Hall K	Hall Kick	146	Slam S	Slam Snare	196	RRdBIC	Rock Ride Bell Cymbal
97	Hard K	Hard Kick	147	SpoutS	Spout Snare	197	RRideC	Rock Ride Cymbal
98	HousK1	House Kick 1	148	StickS	Stick Snare	198	SplshC	Splash Cymbal
99	HousK2	House Kick 2	149	TR808S	TR-808 Snare	199	Cowbel	Cowbell
100	MapleK	Maple Kick	150	TR909S	TR-909 Snare	200	Tambrn	Tambourine
101	MondoK	Mondo Kick	151	TightS	Tight Snare	201	Casta	Hall Castanets
102	MonstK	Monster Kick	152	Tiny S	Tiny Snare	202	SlBell	Sleigh Bell
103	MufflK	Muffle Kick	153	Wood S	Wood Snare	203	TriMt	Triangle Mute
104	Real K	Real Kick	154	AmbStk	Ambient Side Stick	204	TriOp	Triangle Open
105	RevrBK	Reverb Kick	155	808Stk	TR-808 Side Stick	205	WodBlk	Wood Block
106	Room K	Room Kick	156	AmboT1	Ambient Tom 1	206	BongoH	Bongo High
107	RubbrK	Rubber Kick	157	AmboT2	Ambient Tom 2	207	BongoL	Bongo Low
108	SoftK1	Soft Kick 1	158	AmboT3	Ambient Tom 3	208	CngHMT	Conga High Mute
109	SoftK2	Soft Kick 2	159	AmboT4	Ambient Tom 4	209	CngSlp	Conga High Slap
110	SolidK	Solid Kick	160	BendT1	Bend Tom 1	210	CngHOp	Conga High Open
111	TR808K	TR-808 Kick	161	BendT2	Bend Tom 2	211	CngLOp	Conga Low Open
112	TR909K	TR-909 Kick	162	BendT3	Bend Tom 3	212	Timbal	Timbale
113	TightK	Tight Kick	163	BendT4	Bend Tom 4	213	Claves	Claves
114	AcouS1	Acoustic Snare 1	164	BrshT1	Brush Tom 1	214	Vibslp	Vibra-slap
115	AcouS2	Acoustic Snare 2	165	BrshT2	Brush Tom 2	215	GuiroS	Guiro Short
116	BrRl S	Brush Roll Snare	166	BrshT3	Brush Tom 3	216	GuiroL	Guiro Long
117	BrSlS1	Brush Slap Snare 1	167	BrshT4	Brush Tom 4	217	Marcas	Maracas
118	BrSlS2	Brush Slap Snare 2	168	DublT1	Double Head Tom 1	218	Shaker	Shaker
119	BrSwiS	Brush Swish Snare	169	DublT2	Double Head Tom 2	219	Cabasa	Cabasa
120	Cool S	Cool Snare	170	DublT3	Double Head Tom 3	220	WhisIS	Whistle Short
121	DanceS	Dance Snare	171	DublT4	Double Head Tom	221	WhisIL	Whistle Long

No.	Display	Instrument Name	No.	Display	Instrument Name	No.	Display	Instrument Name
222	Agogo	Agogo	234	808Cow	TR-808 Cowbell	246	GtScr1	Guitar Scrape1
223	Cuica	Cuica	235	808Cng	TR-808 Conga	247	GtScr2	Guitar Scrape2
224	PandOp	Pandiero Open	236	Flex	Flex	248	GtScr3	Guitar Scrape3
225	PandMt	Pandiero Mute	237	Flip	Flip	249	RevKik	Reverse Kick
226	SurdOp	Surdo Open	238	Gong	Gong	250	RevSnr	Reverse Snare
227	SurdMt	Surdo Mute	239	HiQ	High Q	251	RevTom	Reverse Tom
228	Tambrm	Tamborim	240	Knock	Knocker	252	RevCym	Reverse Cymbal
229	78Cow	CR-78 Cowbell	241	ScrPl	Scratch Pull	253	RevClp	Reverse Clap
230	78Beat	CR-78 Metallic Beat	242	ScrPs	Scratch Push	254	RevBt	Reverse Beat
231	78Guir	CR-78 Guiro	243	Snaps	Snaps	255	RevTam	Reverse Tambourine
232	78Tamb	CR-78 Tambourine	244	Storm	Storm			
233	808Clp	TR-808 Clap	245	BSlide	Bass Slide			

* *Instrument No. 0-81 can only be assigned to Tracks 1-3.*

* *The Instruments numbered from 82-255 (rhythm and effect sounds) can only be assigned to the DRUM Track.*

Pitch (-700 to +700)

Provides selection of 141 levels for the Pitch of an Instrument assigned to a key pad.

* *It is a function that is effective only for the DRUM TRACK. ("****" will be displayed if you select any of the other Tracks.)*

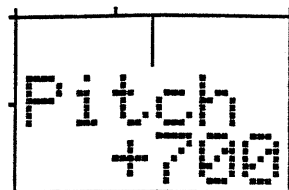

Decay (-31 to + 31)

Provides selection of 63 levels for the Decay of an Instrument assigned to a key pad.

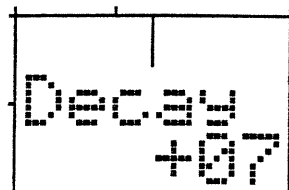

Pan

Provides selection of 15 positions for the Pan setting (sound image localization within the stereo spectrum) of an Instrument assigned to a key pad.

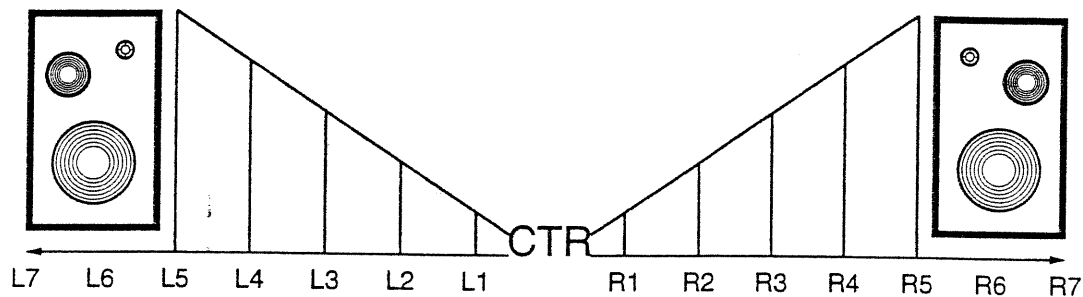
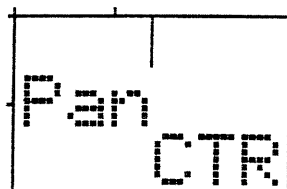

Volume (0 to 15)

Provides selection of 16 levels for the Volume of an Instrument assigned to a key pad.

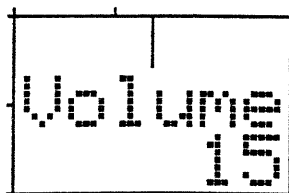

* *With the volume set at 0, no sound will be produced.*

Align

This setting determines the pitch alignment for the key pads. It is a function that is effective only for TRACKS 1 to 3.

- * This is a common setting for all Kits. You cannot set this for each Kit.

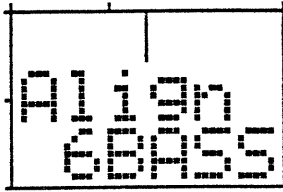

GUITAR: Basic guitar tuning

Open String Key	Fret Number						19
	1	2	3	4	5	—	
E4	F4	F [♯] 4	G4	G [♯] 4	A4	—	B5
B3	C4	C [♯] 4	D4	D [♯] 4	E4	—	F [♯] 5
G3	G [♯] 2	A3	A [♯] 3	B3	C4	—	D5
D3	D [♯] 3	E3	F3	F [♯] 3	G3	—	A4
A2	A [♯] 2	B2	C3	C [♯] 3	D3	—	E4
E2	F2	F [♯] 2	G2	G [♯] 2	A2	—	B3

6BASS: Tuning for a 6 string bass (One octave higher than actual bass tuning)

Open String Key	Fret Number						19
	1	2	3	4	5	—	
C4	C [♯] 4	D4	D [♯] 4	E4	F4	—	G6
G3	G [♯] 3	A3	A [♯] 3	B3	C4	—	D5
D3	D [♯] 3	E3	F3	F [♯] 3	G3	—	A4
A2	A [♯] 2	B2	C3	C [♯] 3	D3	—	E4
E2	F2	F [♯] 2	G2	G [♯] 2	A2	—	B3
B1	C2	C [♯] 2	D2	D [♯] 2	E2	—	F [♯] 3

- * If you wish to get the actual pitch of a bass guitar, you should carry out the Octave Shift procedure (P.6-8).

A scal : Higher range

Open String Key	Fret Number						23
	1	2	3	4	5		
A ³	B ₃	C ₄	C [♯] ₄	D ₄	D [♯] ₄	—	A ₅
F ₃	F [♯] ₃	G ₃	G [♯] ₃	A ₃	A [♯] ₃	—	F ₅
C ₃	C [♯] ₃	D ₃	D [♯] ₃	E ₃	F ₃	—	C [♯] ₅
G ₂	G [♯] ₂	A ₂	A [♯] ₂	B ₂	C ₃	—	F [♯] ₄
D ₂	D [♯] ₂	E ₂	F ₂	F [♯] ₂	G ₂	—	C [♯] ₄
A ₁	A [♯] ₁	B ₂	C ₂	C [♯] ₂	D ₂	—	G [♯] ₃

C scal : Lower range

Open String Key	Fret Number						23
	1	2	3	4	5		
C [♯] ₅	D ₅	D [♯] ₅	E ₅	F ₅	F [♯] ₅	—	C ₇
G [♯] ₄	A ₄	A [♯] ₄	B ₄	C ₅	C [♯] ₅	—	G ₆
D [♯] ₄	E ₄	F ₄	F [♯] ₄	G ₄	G [♯] ₄	—	D ₆
A [♯] ₃	B ₃	C ₄	C [♯] ₄	D ₄	D [♯] ₄	—	A ₅
F ₃	F [♯] ₃	G ₃	G [♯] ₃	A ₃	A [♯] ₃	—	E ₅
C ₃	C [♯] ₃	D ₃	D [♯] ₃	E ₃	F ₃	—	B ₄

Vertcl : Arranged the pitches in vertical line.

Open String Key	Fret Number						8	9	10	11
	1	2	3	4	5					
D ₂	G [♯] ₂	D ₃	G [♯] ₃	D ₄	G [♯] ₄	—	D ₆	G [♯] ₆	C ₇	C ₇
C [♯] ₂	G ₂	C [♯] ₃	G ₃	C [♯] ₄	G ₄	—	C [♯] ₆	G ₆	C ₇	C ₇
C ₂	F [♯] ₂	C ₃	F [♯] ₃	C ₄	F [♯] ₄	—	C ₆	F [♯] ₆	C ₇	C ₇
B ₁	F ₂	B ₂	F ₃	B ₃	F ₄	—	B ₅	F ₆	B ₆	C ₇
A [♯] ₁	E ₂	A [♯] ₂	E ₃	A [♯] ₃	E ₄	—	A [♯] ₅	E ₆	A [♯] ₆	C ₇
A ₁	D [♯] ₂	A ₂	D [♯] ₃	A ₃	D [♯] ₄	—	A ₅	D [♯] ₆	A ₆	C ₇

* On and after the 11th fret, all the frets are assigned to C7.

* The tuning of the key pads can be shifted by pressing [<]FRET[>] when TRACKs 1-3 are selected. (The fret that the leftmost column corresponds to is shown in the display.)

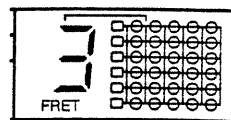

For information about the amount by which it can be shifted, see Chapter 10, "[2] Adjusts the Amount of Fret Shift" (p. 10-3).

OctSft : Octave Shift

When you have TRACKs 1-3 selected, this setting allows you to raise or lower (by an octave) the pitch of what is played by the pads and the Note Numbers that arrive over MIDI (+1, 0, -1)

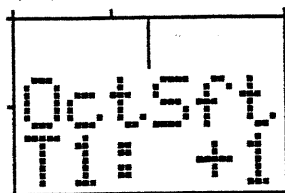

“***” will be displayed when you select the Drum Track.

2. Editing

- (1) Select the Pad mode.
Press [PAD] while holding down [SHIFT ERASE] and confirm that “PAD” has been displayed.
- (2) Press [<]/[>] to select the parameter to be edited.

When Instrument Assign has been selected:

- (3) Select “Inst” in step (2).
- (4) Press the key pad to which the Instrument to be edited is assigned. The name of the Instrument currently assigned is shown in the display.
- (5) Select the new Instrument to be assigned using the TEMPO/DATA knob.

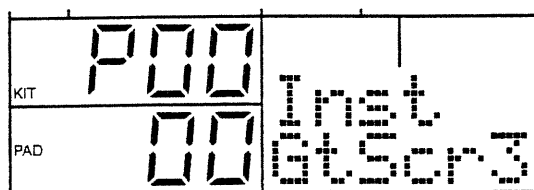

* Even if the Instrument name is shown in the display when a Preset Kit is selected, you cannot make changes in its assignment.

When another parameter has been selected:

- (3) Press the key pad to which the Instrument to be edited is assigned.
- (4) Make settings for the value of parameters using the TEMPO/DATA knob.

(2) Copying Kits

You can copy the contents of one Kit to a User Kit (U00 to U15).

This is convenient for times when you wish to use an existing Kit you have created, or a Preset Kit after making some alterations in its settings.

- (1) Press [KIT] and confirm that "KIT" has been displayed.
- (2) Select the Kit at the copy source using the TEMPO/DATA knob.
- (3) Press [COPY] while holding down [SHIFT ERASE] and confirm that "Copy?" has appeared in the display.
- (4) Select the Kit (Number) at the copy destination using the TEMPO/DATA knob.

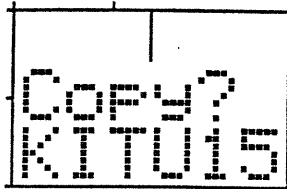

** Preset Kits cannot be selected.*

- (5) Press [ENTER].
The message "Sure?" appears, asking you to confirm your choice.
- (6) To proceed with the copy, press [ENTER].
To cancel the procedure, press [EXIT].

Chapter 7

Using the Chord Functions

** When the Drum Track is selected, the Chord functions cannot be used.*

For instructions on how to input chords, please see Chapter 3, "[1] 4. Entering Chords" (p. 3-9).

(1) Making changes in the Chord Type (Chord Assign)

The following two types of Chord Assign are available.

Chord Type Assign

Allows you to assign Chord Types that are different than those printed on the key pads (top three rows).

- (1) Select the Chord Type Assign mode.

Press [TYPE ASGN].

- (2) Press the key pad (in the top three rows) to which you wish to assign a new Chord type. The pad number is shown in the display.

The Chord Type setting can also be made for an Open String key. The "numbers" of the Open String keys are a, b, c, and so forth, starting at the top. When pressed, the corresponding letter will be shown in the display, the same way as with the numbers for the other key pads.

- (3) Make the settings for the Chord Type you wish to assign using the TEMPO/DATA knob.

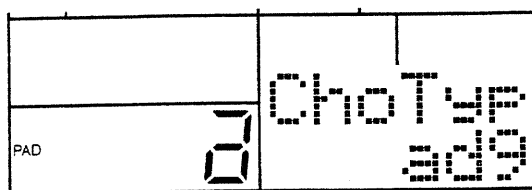

- (4) Return to where you were originally.
Once again press [TYPE ASGN].

Chord Variation Assign

For every chord, you can also specify an inversion (different voicing, different fingering). You make changes in the inversion for every root, rather than for every chord type. (For example, alter the inversions with Am and Dm.)

- (1) Select the mode for specifying inversions.
Press [VARI ASGN].
The unit is set automatically to Chord ON (Chord Input mode), and "CHORD" will be displayed at the center of the display near the top.
- (2) Specify the chord for which you want to make changes in the inversion. Specify the root of the chord using the bottom three rows of key pads, and specify a Chord Type using the top three rows of key pads.
- (3) Select the inversion using the TEMPO/DATA knob. The selected inversion is displayed in the FRET display portion at the right of the display.

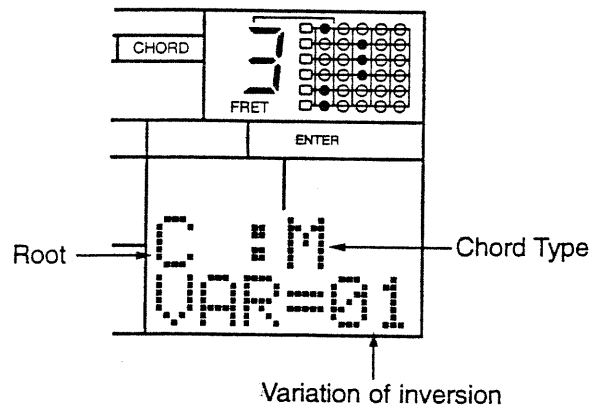

- (4) Return to where you were originally.
Once again press [VAR ASGN].

(2) Defining Original Chords (Edit Chord)

This feature allows you to add or delete certain component notes from a Preset Chord and then store this creation as an Original Chord. Such Original Chords must be defined with respect to each root, rather than for every chord type.

Four Original Chords can be created for each root.

- (1) Select the Chord Input mode.

Press [ON/OFF] and confirm that "CHORD" appears in the center of the display near the left.

- (2) Specify the Chord you wish to edit. Specify the root of the chord using the bottom three rows of key pads, and specify a Chord Type using the top three rows of key pads. The component notes of the chord are shown in the display.

- (3) Select the Edit Chord mode.

Press [EDIT CHORD] while holding down [SHIFT ERASE]. "EdtCho" will be shown in the display.

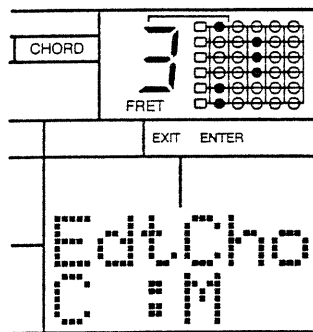

- (4) Press the key pads to add component notes to the chord, or to delete them.

Press the key pad corresponding to the position where you want to add or delete a note. With each press, that position is switched ON or OFF.

The FRET display corresponds with the key pads. Every position that is turned ON lights up.

Example)

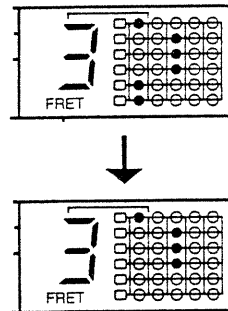
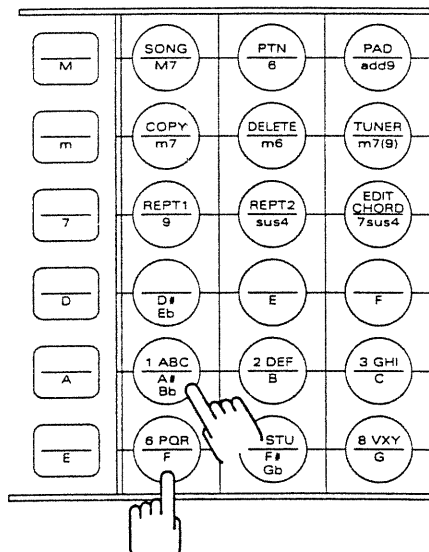

- (5) Press [ENTER] when finished editing.

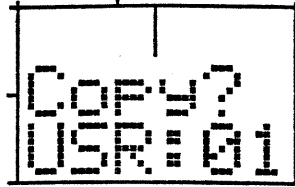

- (6) To store the edited chord, select the desired Variation number of the User Chord using the TEMPO/DATA knob.
In this example, the edited chord will be copied to: Root: C; Chord Type: USR; Variation: 01.
- (7) Press [ENTER] or [EXIT].

* *Chords created using the Edit Chord function can be used by selecting Chord Type "USR" (VAR 01 — 04 are available for Chord Type Assign).*

While editing chords, you can hear the Chord harmony shown in the Fret Display by pressing [ACC1] or [ACC2]. (At this moment, no Accent is applied.)

(3) Using Original Chord

Original chords need to have a chord type of "USR," and must be stored at the Variation 01-04 locations. For this reason, you need to use Chord Type Assign (p. 7-2) to assign the "USR" chord type to the key pads.

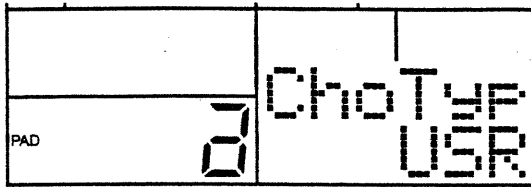

In addition, you need to set the chord as being a Variation from 01-04 using Chord Variation Assign (p. 7-3).

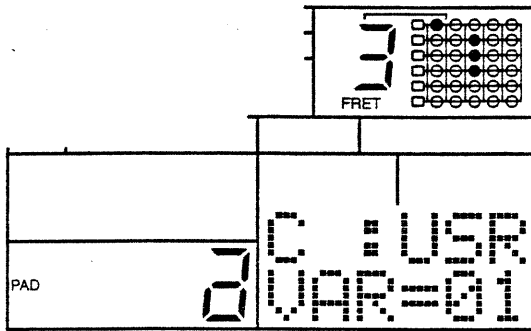

(How Chords Are Stored in the DR-5)

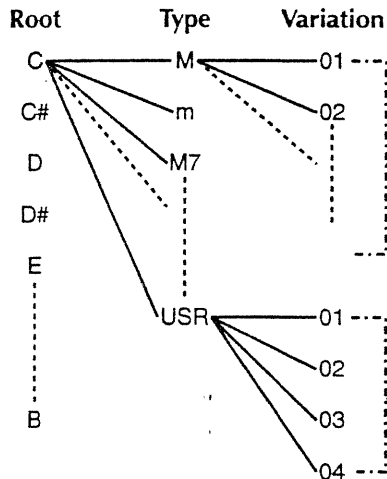

Four separate chords that have been defined using "Edit Chord" can be stored.

Chapter 8

Using a Guitar for Input

Beyond simply providing for the use of the key pads in order to input patterns, the DR-5 also allows you to connect a guitar to its GUITAR IN jack and input patterns by playing the guitar.

(1) Functions when using a Guitar for Input

Tuner

The DR-5 can be used for tuning a guitar. The setting allows you to set the standard pitch to be used when tuning.

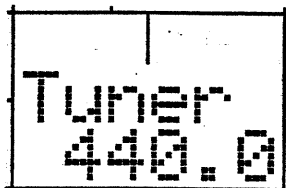

ExtPit: External Pitched instrument Switch (REC / ON / OFF)

In order to input a pattern using a guitar, the unit reads the pitch of the sound (audio signal) of the guitar input at GUITAR IN and converts it to a digital signal (Pitch Conversion). This is then used for input into the pattern. This setting specifies whether or not you are going to use a guitar (an instrument connected to the GUITAR IN jack) for inputting patterns.

When the External Pitch Switch is set to ON ("EXT" is shown in display), the Instrument of the selected Kit will be sounded using pitches which correlate to the signals input to GUITAR IN (only for Tracks 1-3).

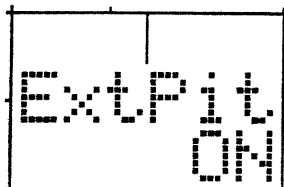

If you set this to "REC," the pitch of the guitar will be converted to a digital signal only during Realtime Write. ("EXT" is displayed only when writing in realtime.)

When the Drum Track is selected, the Instrument which corresponds to the pitch that has been input (the Instrument assigned to the key pad for that pitch) will be sounded.

For example, if you play the note "do" at fret 3 of the 5th string, the sound of the key pad which corresponds to C3 (Note Number 48) will be sounded (within the Drum Track).

In this case, the pitch will not change.

GTR In: Guitar Input Mode

This function allows you to select how to handle the signals from the GUITAR IN jack.

This function has three modes as follows:

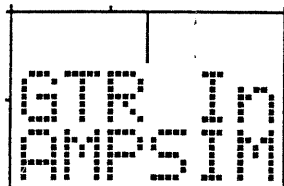

AMPSIM: The signals input at the GUITAR IN jack are mixed and output to the Output Jacks with the simulation of a guitar amplifier sound.

BYPASS: The signals input at the GUITAR IN jack are mixed and output to the Output Jacks without simulation of a guitar amplifier sound (directly output).

MIXOFF: The signals input at the GUITAR IN jack are not mixed or output to the Output Jacks, regardless of the setting of the Input Volume.

If you wish, you can play the guitar to sound the DR-5's sounds. (The sound from the guitar itself will not be output.)

** Even if you set this to "MIXOFF," you can use the Pitch to Digital Signal function according to the setting of the External Pitch Switch. If you wish, you can play the guitar to sound the DR-5's sounds. (The sound from the guitar itself will not be output.)*

(2) Connecting a Guitar and Practicing

You can practice playing along with Patterns and Songs after connecting a guitar to the DR-5. (Guitar signals input to the DR-5 will be mixed with the sound it generates and output from its stereo outputs.)

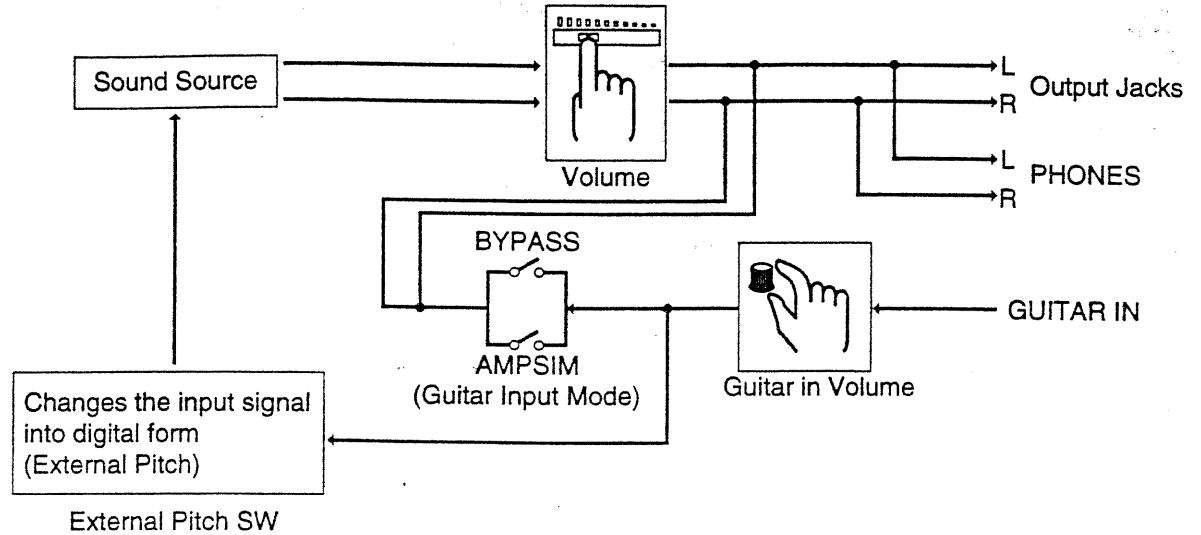

- (1) Make the connections as shown below.

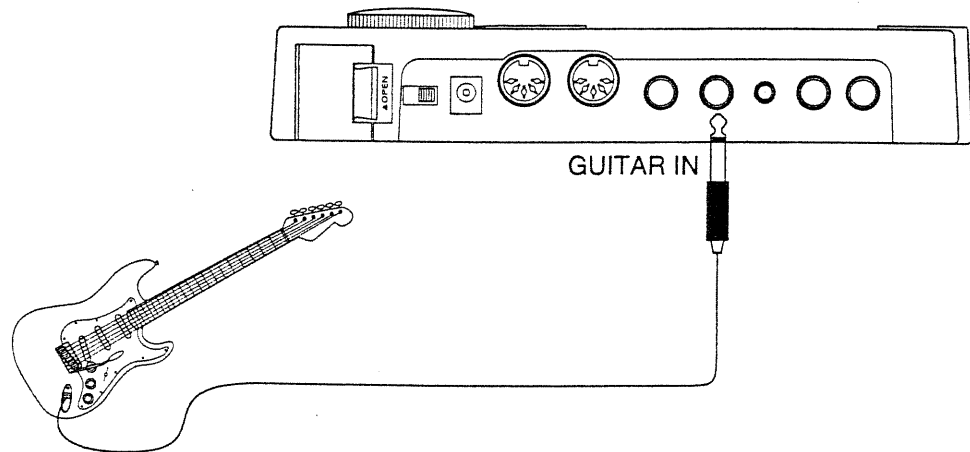

- (2) Press [EXT PITCH] (the third pad from the top in the second column from the right) while holding down [SHIFT ERASE].
- (3) Set the External Pitch Switch to "OFF" using the TEMPO/DATA knob.

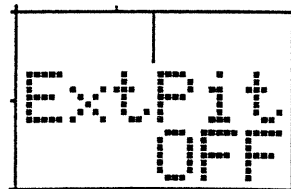

- (4) Press [EXIT] when you are finished making the settings.

- (5) Press [GTR IN] while holding down [SHIFT ERASE].
Now you can set the Guitar Input mode (see previous page).

- (6) Set the Guitar Input Mode to "AMPSIM" or "BYPASS."

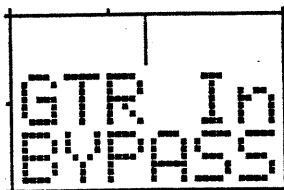

- (7) Press [EXIT] when you are finished making the settings.

When you play a guitar with this setup, its sound will be output (without modification) from the stereo outputs of the DR-5. Since the External Pitch Switch is OFF, the internal Instruments will not produce sound.

The volume of the guitar can be adjusted using the INPUT VOL knob.

(3) Tuner Function

The DR-5 can also be used for tuning a guitar.

- (1) Connect a guitar to the GUITAR IN jack.
- (2) Press [TUNER] (the second pad from the top in the third column from the right) while holding down [SHIFT ERASE].
This places the unit in the Tuner mode.
- (3) Select standard pitch (A=415.3 to 466.2 Hz) using the TEMPO/DATA knob.

* The Standard pitch setting here serves both as the Tuner's Standard pitch and the internal sound module's Standard pitch (We call this "Master Tune."). The displayed value is the pitch (frequency) of the A4 key of a keyboard.

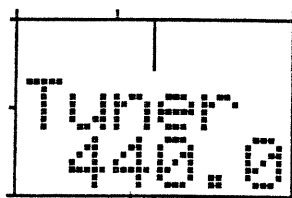

Standard Pitch

- (4) When you play the guitar, the tuning indication shown in the illustration below will appear for a short while.

Pitch display when note B is input.

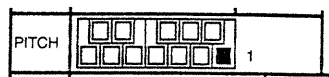

Sound being input is much higher than standard pitch.

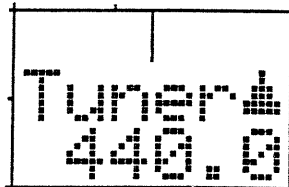

Sound being input is somewhat lower than standard pitch.

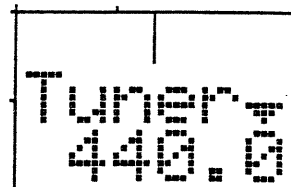

When in tune

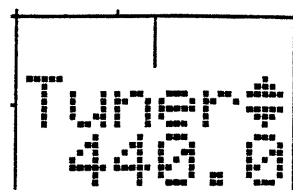

(4) Inputting Patterns Using the Guitar

Carry out the steps below to input a pattern using the guitar instead of the key pads.

* *Several notes (such as chords) cannot be input simultaneously.*

- (1) Connect a guitar to the GUITAR IN jack.
- (2) Set the unit to the initial settings for Pattern Write (p. 3-4).
- (3) Press [EXT PITCH] (third pad from the top in the second column from the right) while holding down [SHIFT ERASE].
- (4) Set the External Pitch Switch to "ON" or "REC" using the TEMPO/DATA knob. "EXT" is shown in the center of the display near the top.

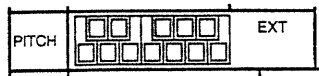

- (5) Press [GTR IN] while holding down [SHIFT ERASE].
 - (6) Set the Guitar Input Mode to "OFF."
- * *Procedures (5) and (6) mute the actual sound input at the GUITAR IN jack (see page 8-2).*
- (7) Use the same recording method as usual (p. 3-6). Simply play the guitar to input the pattern instead of using the key pads.
The Instrument currently selected on the DR-5 will be sounded in accord with the pitch that is input. (The raw sound of the guitar will also be output from the unit's stereo outputs.)

* *The External Pitch function causes pitch bending to be applied to the output sound whenever you bend the guitar's strings while playing. However, the pitch bend effect will not be heard when using Real-Time Write to create patterns. The unit will be sounded chromatically (in semitone steps). Further, pitch bend information cannot be stored within patterns.*

* *At other times (when not carrying out Real-Time Write) you should select a Track not being used by the patterns when you want to play the guitar while patterns are played. If you should select a Track used by a pattern, any pitch bend information produced when you bend strings (or use any similar pitch altering techniques) will affect the data in the Track, so the pitch of the pattern may not be reproduced correctly. (In this case, stop playing once, and then select a Pattern or a Song again.)*

(Sounding Pitches Reliably)

The DR-5's External Pitch function can only recognize one note at a time. For this reason you need to play, then mute each note individually in order to have the DR-5 produce the notes correctly when using the guitar to play it.

If you are unable to achieve satisfactory results even though you are muting each and every note after it is played, consider if the problem could be with the volume setting you have on your guitar, the selection for the pickup, the settings for tone control, or the manner in which you are picking (pick or fingers). You should also check to be sure you have the Input Volume setting on the DR-5 at an optimum level, since this has a great affect on the overall performance.

Chapter 9

Connecting with External MIDI Devices

(1) About MIDI

MIDI is an acronym for "Musical Instrument Digital Interface." It is an international standard that allows for data to be exchanged among all MIDI compatible instruments. (Such data can, for example, describe what is played, or call for changes in sounds.)

As long as they are MIDI compatible, all devices can exchange whatever performance data they are equipped to receive, regardless of differences in model or manufacturer.

When using the MIDI standard, events such as playing on a keyboard, or depressing a pedal are converted into MIDI data.

1. Exchanging MIDI Data

The following explains how MIDI data is communicated.

About MIDI Connectors

In carrying out the exchange of MIDI data, the three connectors shown below are used. MIDI cables can be connected to these connectors in various ways depending on how you intend to use the MIDI features of a unit.

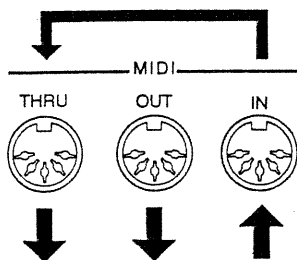

MIDI IN: Receives data from another MIDI device.

MIDI OUT: Transmits data originating in a unit.

MIDI THRU: Sends out an exact copy of the data received at MIDI IN.

** In theory, any number of MIDI devices could be connected together using MIDI THRU connectors. But in actuality, you should try to limit the total number of devices to 4 or 5. This is because the further distant a device ends up being located from others in the chain, the more signal delay there is that could occur. The possibility for error due to a deterioration in the quality of the signal also increases.*

MIDI IN and MIDI OUT connectors are located on the rear panel of the DR-5. The MIDI OUT connector can also function as a MIDI THRU connector when Soft Thru is set to "ON." For details please see p. 9-10.

MIDI Channels

With MIDI, a single cable can be used to carry differing sets of performance information to a number of MIDI devices. This is possible thanks to the concept of MIDI channels.

MIDI channels are comparable in some ways to the channels on a television set. This is because, in both cases, the information on any particular channel is conveyed only when the receiver is set to the same channel that is being used for transmission.

TV messages from various TV Stations are sent through the antenna's cable.

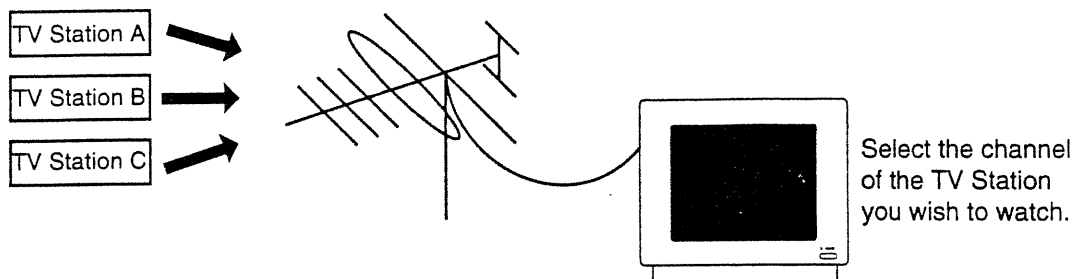

The channels available with MIDI range from 1 to 16. When a musical instrument (the receiver) is set so its channel matches the MIDI channel used by the transmitting device, the MIDI data is communicated successfully. For example, when the MIDI channels are set as illustrated below, sound will be produced only by sound module B when you play the keyboard.

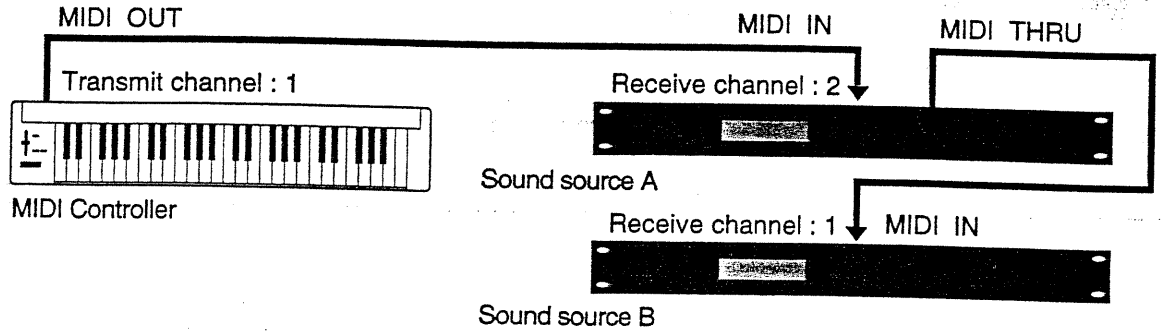

However, if the Omni mode is set to ON, all data will be recognized, no matter which MIDI channel it has arrived on. When the Omni mode is set to OFF, only data arriving on a specified channel will be recognized.

2. MIDI Messages Recognized by the DR-5

In order to be able to communicate a rich variety of information about a performance, MIDI provides for the use of many different types of data (messages). MIDI messages can be divided into two main types: Messages that are handled on an individual channel basis (Channel Messages); and messages that are handled independently of channels (System Messages).

Messages Handled for Each MIDI Channel (Channel Messages)

These messages are used to convey the actions occurring during play of a musical instrument. They alone can (in most circumstances) provide a sufficient amount of control over a device. The actual result obtained by any particular type of MIDI message is determined by the settings on the sound generating unit that receives them.

Note Messages

These messages convey what has been played during a performance. (They are equivalent to the performance information that would be generated when playing the keys of a keyboard.)

The following Note Messages are provided:

- Note Number: Type or pitch of the sound of a key pad. (On a keyboard, the number representing the position of the key.)
- Note ON: The action of tapping a key pad (pressing a key).
- Note OFF: The action of releasing a key pad (or keyboard key).
- Velocity: Force with which a key pad (or keyboard key) is hit.

Correspondence between Note Numbers and Note Names

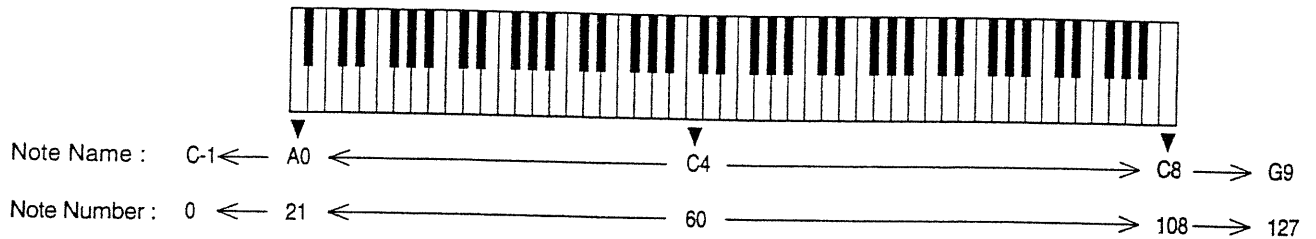

About Note Numbers

Note Numbers use the numbers 0 through 127, each of which denotes one of the positions (itches) of keys on a keyboard. Number 60 represents middle C (C4).
On the DR-5, Note Numbers are handled differently depending on the track.

In the case of the Drum Track:

With the Drum Track on the DR-5, a separate Note Number is assigned to every key pad. As a result, when a Note Number is received, the Instrument that is assigned to the key pad to which that particular Note Number is assigned will sound. This allows specific Instruments to be sounded rather than others.

In the case of Tracks 1-3:

With Tracks 1-3, the Note Number translates directly into the pitch that an Instrument is to sound at when a particular Note Number is received.

Note, however, that if Octave Shift (p. 6-8) is active, the pitch at which an Instrument will actually sound will differ from the Note Number conveyed by MIDI.

The note numbers from 0 — 127 can be used with Tracks 1 — 3. However, with some Instruments, the pitch will no longer change once you go above or below certain note numbers.

Note also that only note numbers in the range shown below will be valid when creating patterns (Realtime Write).

A1C2.....C3.....C4.....C5.....C6.....C7
33.....36.....48.....60.....72.....84.....96

If note numbers that are outside the range shown above are received, they will not be sounded, nor will they be stored in the pattern.

About Velocity

The pads on the DR-5 cannot be used to express differing amounts of velocity (volume). However, by using the unit's panel, four different velocity levels can be expressed in terms of an Accent (p. 1-10). These four levels are: Acc1, Acc2, Acc3, and no accent at all. Whenever the unit transmits data, the value for velocity will be equivalent to one of these Accent levels.

When receiving velocity messages, the unit will produce sound in keeping with the actual value for the velocity. However, when such data is being input for use in creating patterns, the velocity will be interpreted as being one of the four Accent values.

- * *The unit's sound generator will respond to the velocity information included in note data, and produce its sound accordingly at any time other than when using Realtime Write to create patterns.*

Program Change

On a keyboard, these messages are used to select the sound to be played. On the DR-5, they are used to switch Kits (p. 2-6).

MIDI channel for Drum Track: Selects Kits

- * *The DR-5 is capable of transmission/reception of Program Changes.*
- * *Please see p.9-9 for the Kits and Program Numbers correspondence chart.*

Pitch Bend

These messages are used to convey the action of a Pitch Bend Lever (pitch changes). They describe the degree to which the lever has been moved. The DR-5 is capable of responding to any Pitch Bend messages it may receive from an external MIDI keyboard.

- * *When using Real-Time Write to create patterns, Pitch Bend messages will not be recognized. Moreover, such messages cannot be stored within patterns.*

Control Change

These messages are used to enhance the expressiveness of a performance, and include messages describing modulation and panning. Each of the various features on a device are given a Control Number in order to distinguish between them. The particular controls which are made available for use on a MIDI device vary depending on the type of unit it is. The DR-5 allows an external MIDI device to control its panning and volume using these messages.

- * *When using Real-Time Write to create patterns, Hold 1 messages will not be recognized. Moreover, such messages cannot be stored within patterns.*

Messages Handled Independently of MIDI Channels (System Messages)

The System Messages include Exclusive messages, messages that make synchronized play possible, as well as messages used to diagnose and prevent malfunctions. The DR-5 recognizes the messages necessary for synchronized play.

Common

This type of message includes Song Select (used to select songs) and Song Position Pointer (which denotes the position playback has currently reached within a song).

Realtime

This type of message is employed during synchronized play. Included are the clock signals (used to match tempos), and the messages concerned with playback: Start, Stop, and Continue-Start (restarts play of a song after it has been stopped part way through).

These messages also include Active Sensing, which are used to prevent having sound modules sound endlessly as the result of a MIDI cable becoming disconnected.

System Exclusive

This type of message is used when you want to transfer the settings for patterns or the unit as a whole to another DR-5, or an external sequencer (or the like) for storage.

(MIDI Implementation Chart)

MIDI has made it possible for a wide range of musical instruments to communicate with each other, but that doesn't mean that the many possible types of data will be understood by all devices.

For example, you could try using a keyboard's aftertouch to obtain control over something, but if the sound module you have connected doesn't respond to aftertouch, no effect will be obtained.

Actually, the only communication possible between MIDI devices that are connected together deals with data that both of the MIDI devices understand.

It is for this reason that every owner's manual, for all kinds of MIDI devices, always includes a MIDI Implementation Chart as a quick reference to the types of MIDI messages it is capable of handling. You can compare the MIDI Implementation Charts for both devices in order to find out which types of data can be communicated between them. Also, since the size of the chart is standardized, you can place them so they overlap, and more easily compare the receiving device with the transmitting device.

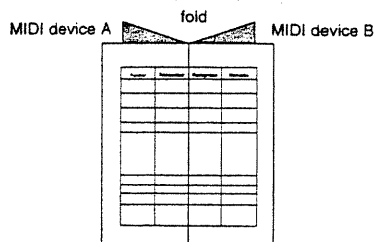

(2) Synchronized play

This feature allows the DR-5 to be synchronized with an external MIDI device while it is being played. Playback on the DR-5 can be controlled by operating the controls for tempo and start/stop on the external device, or the DR-5 can be used to control the external device.

If the master device (the transmitting unit) is capable of transmitting Song select and Song Position Pointer MIDI messages, the Song Number and position within the Song specified by the master will be also be specified on the DR-5.

If the slave device (the receiving unit) is capable of recognizing Song select and Song Position Pointer MIDI messages, the Song Number and position within the Song specified by the DR-5 will be also be specified on the slave device.

1. Making the Connections

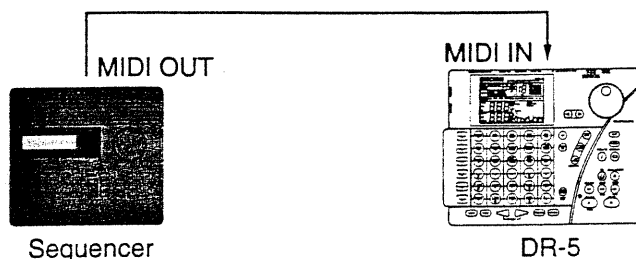

2. Settings for the Sync Mode

The Sync Mode setting allows you to select the device you wish to synchronize with.

INT: Synchronizes the external MIDI device with the tempo of the DR-5 (master).

MIDI: Synchronizes the DR-5 with the MIDI clock signal from an external MIDI device (slave).

Carry out the following procedure while play of a Song or Pattern is stopped.

- (1) Get into the MIDI mode.

Press [MIDI] (second pad from the right on the top row of key pads) while holding down [SHIFT ERASE], and confirm that "MIDI" appears in the upper-middle part of the display.

- (2) Switch the page using [</>], and confirm that "Sync" appears at the lower-right part of the display.

- (3) Select the Sync Mode using the TEMPO/DATA knob.

Set it to either "MIDI" or "INT."

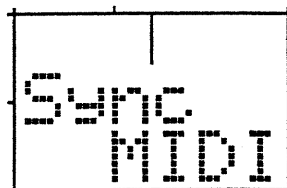

3. About the Tempo Display

When the Sync Mode is set to MIDI Sync, the tempo indication will change to that shown below, and you will no longer be able to set the tempo on the DR-5.

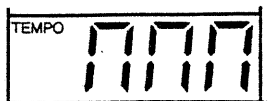

If you press [START] while the timing clock has not yet arrived from the external device, the tempo indication will change to that normally shown during play (shown below), but play will not actually start until the timing clock arrives.

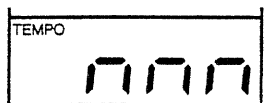

(3) Sounding an External MIDI Device/ Using the Unit as a MIDI Sound Generator

The DR-5's sounds can be triggered using the performance data sent to it from an external MIDI device. The DR-5 can also be used to play an external MIDI device.

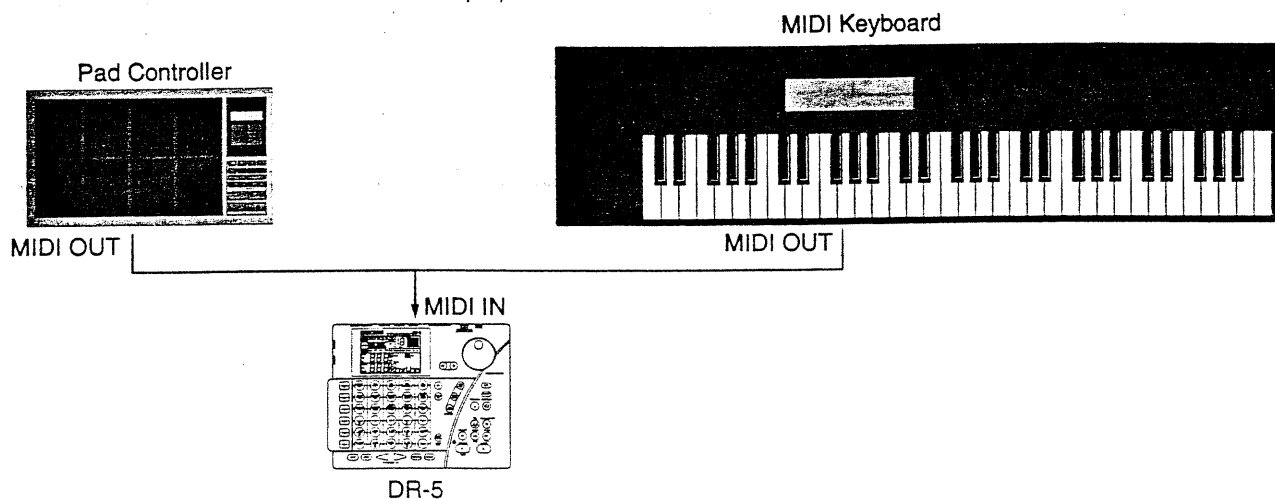

1. About the Parameters

When wishing to have an external device play the DR-5, or use it to play the external device, you need to make settings for the following parameters.

Note#: Note Number Assign (0-127 / OFF)

- * Can only be specified for the Drum Track. (Concerning Tracks 1-3, please refer to "Note Messages," p. 9-3.)
- * Can also be set for every Kit.

This setting determines which Note Number will cause which Instrument to be sounded when a Note ON is received on the set MIDI channel. In actuality, the Instrument assigned to the key pad which is assigned the Note Number that was received will sound.

When you transmit a Note ON from the DR-5, the Note Number set here is used, but Instruments that are not assigned to any key pad will not be transmitted. Also, when the same Note Number has been assigned to a multiple number of key pads, only one Instrument will sound. In this case, the Instrument assigned to the key pad having the smallest number (Pad Number) will sound.

TRACK SELECT	DRUM		EXIT
KIT	400	Ride	C
PAD	00		51

MIDIch: MIDI Channel (OFF, 1-16)

Sets the MIDI channel on which data will be received from an external MIDI device. Because the DR-5 is always at OMNI OFF, you need to match it with the MIDI channel used by the transmitting unit. The MIDI channel set here is used as well for transmission. The MIDI channel can be set independently for each Track.

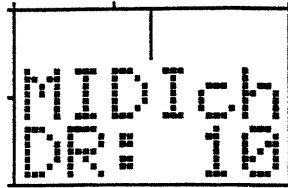

Prog: Program Change (OFF/ON)

This setting specifies whether or not the unit is to carry out transmission/reception of Program Change messages.

When set to ON, the DR-5 will switch to a different Kit when it receives a Program Change on the MIDI channel which are set to DRUM TRACK.

When it receives a Program Change, the DR-5 will switch to a different Kit if it corresponds with the Drum Track if the channel on which the message traveled is one corresponding to DRUM Track.

Whenever you change patterns during Pattern play, the DR-5 will transmit the corresponding Program change message.

In addition, whenever a pattern used in a Song is changed while a Song is playing, a Program Change is transmitted by the unit.

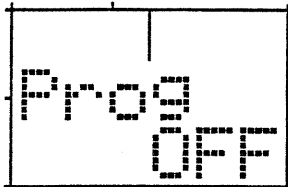

Kit No.	PC No.	Kit No.	PC No.	Kit No.	PC No.	Kit No.	PC No.
P00	65	P16	81	P32	97	U00	105
P01	66	P17	82	P33	98	U01	106
P02	67	P18	83	P34	99	U02	107
P03	68	P19	84	P35	100	U03	108
P04	69	P20	85	P36	101	U04	109
P05	70	P21	86	P37	102	U05	110
P06	71	P22	87	P38	103	U06	111
P07	72	P23	88	P39	104	U07	112
P08	73	P24	89	P40	1	U08	113
P09	74	P25	90	P41	9	U09	114
P10	75	P26	91	P42	17	U10	115
P11	76	P27	92	P43	25	U11	116
P12	77	P28	93	P44	26	U12	117
P13	78	P29	94	P45	33	U13	118
P14	79	P30	95	P46	41	U14	119
P15	80	P31	96	P47	49	U15	120

Volume: Volume Switch (1-127, ON/OFF)

This setting allows you to select whether or not to have the DR-5 respond to MIDI Volume and Volume messages. When turned ON, if the DR-5 receives volume messages, the Track volume which is corresponded to received MIDI channel will change. The ON/OFF setting affects all tracks.

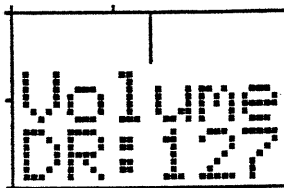
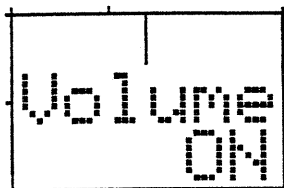

Expr: Expression Switch (ON/OFF)

This setting allows you to select whether or not to receive/transmit expression messages. When turned ON, if the DR-5 receives expression messages, the Track volume which is corresponded to received MIDI channel will change. And when Track Levels are set in the Song, corresponding expression messages will be transmitted.

The values for expression messages are not stored in memory while power is OFF. It is set to the maximum value when power is turned ON.

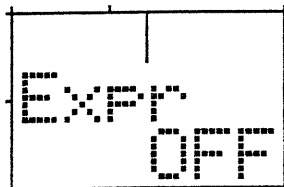

Thru: Soft Thru Switch (ON/OFF)

This setting determines whether or not you wish to have all messages that have been received at MIDI IN to be routed to MIDI OUT. When set to OFF, the received messages are not sent from MIDI IN to MIDI OUT. When set to ON, MIDI OUT behaves like a MIDI THRU. In this case, all messages received at MIDI IN are sent out again without modification from MIDI OUT, but the performance data of the unit itself will no longer be output from MIDI OUT.

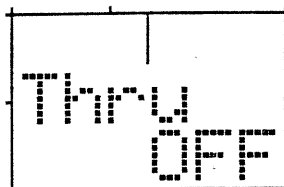

SysEx: System Exclusive Device ID Number (OFF/1-16)

This setting allows you choose whether System Exclusive messages are to be transmitted/received, and to select the Device Number that is to be used.

To successfully carry out transmission/reception, you need to have the Device ID Number matched with that of the other device. When you set it to OFF, Exclusive messages cannot be transmitted/received.

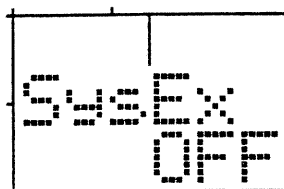

Sync: Sync Mode (INT/MIDI)

This setting is made when you wish to synchronize an external MIDI device and the DR-5 (p. 9-8). To synchronize the DR-5 with an external device, set the DR-5 to "MIDI."

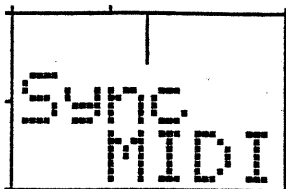

* During MIDI Sync, you cannot make changes in the tempo.

2. Making the Settings

Carry out following procedure with play stopped for Song play or Pattern play.

- (1) Get into the MIDI mode.
Press [MIDI] (second pad from the right on the top row of key pads) while holding down [SHIFT ERASE] and confirm that "MIDI" appears in the upper-middle part of the display.
- (2) Switch the page using [<]/[>], and select the parameter you wish to set.

When Note Number Assign is selected (Drum Track only):

- (3) Press [KIT] and confirm that "KIT" has been displayed.
- (4) Select the Kit using the TEMPO/DATA knob.

* You cannot make changes in the Note Numbers of Preset Kits.

- (5) Once again press [KIT].
- (6) Press [ENTER].

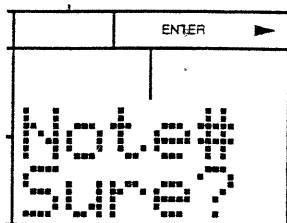

- (7) Press the key pad for which you wish to set the Note Number.

- (8) Select the Note Number using the TEMPO/DATA knob.

TRACK SELECT	DRUM		EXIT
KIT	400	Ride	C
PAD	00		51

When MIDI channel has been selected:

- (3) Select the Track using the TEMPO/DATA knob.
- (4) Using [←]/[→], move the cursor to the MIDI channel.
- (5) Set the channel using the TEMPO/DATA knob.

When some other parameter has been selected:

- (3) Set the value for each parameter using the TEMPO/DATA knob.

(4) Transfer of Data Using Exclusive Messages

By using MIDI Exclusive messages, data stored in this unit can be sent to another DR-5, or a MIDI device capable of storing Exclusive messages.

1. Transmission (Bulk Dump)

Carry out the steps below to send the data stored in the DR-5.

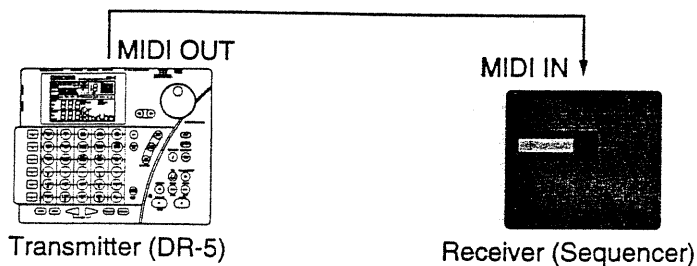

- (1) Get into the MIDI mode.
Press [MIDI] (the second pad from the right in the top row of key pads) while holding down [SHIFT ERASE] and confirm that "MIDI" appears in the upper-middle part of the display.
- (2) Switch the page using [←]/[→], and confirm that "Dump" appears in the display at the lower-right.
- (3) Select the type of data that is to be sent using the TEMPO/DATA knob.
ALL: Send all data. (SEQ and SETUP)
SEQ: Send all Songs and all Patterns.
SETUP: Send settings for Kits, Metronome, Original Chord, Chord Assign, Guitar Input Mode, External Pitch, Footswitch Assign, Fret Shift and MIDI modes other than System Exclusive Device ID Number.

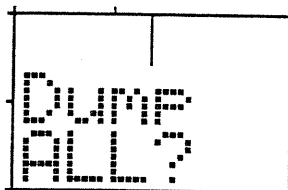

- (4) Press [ENTER]. The message "Sure?" appears, asking you to confirm your choice.
- (5) To carry out the bulk dump, press [ENTER].
To cancel the procedure, press [EXIT].

"TxSys" will be displayed while the transmission takes place.

2. Reception

Carry out the steps below to receive Exclusive messages from another DR-5, or from a MIDI device into which Exclusive data from the DR-5 was previously stored.

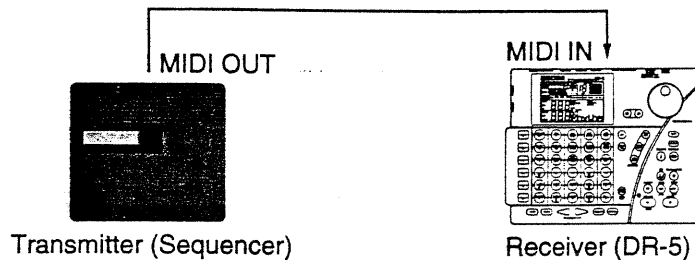

- (1) Get the unit ready for the reception of Exclusive data.
Match the Device ID Number with the external device (p. 9-10).
- (2) With play stopped on the DR-5, have the external device start transmitting Exclusive messages.

"RxSys" will be displayed during reception of Exclusive data.

- * When you want to receive Exclusive data from another DR-5, set both of them so they use the same System Exclusive Device ID Number.
Also, when wishing to receive DR-5 data that was previously saved in a sequencer or the like, set the unit to the same System Exclusive Device ID Number that was used when you originally transmitted the Exclusive messages.*

high

Chapter 10

em

to
re

Other Functions

(1) Foot Switch Setting

This setting allows you to assign the function of any key to a foot switch.

A foot switch jack is provided on the rear panel of the DR-5. Since this is a stereo jack, it allows you to connect two foot switches (such as the FS-5U; optionally available), by making use of a specialized cable (PCS-31; optionally available).

The two plugs on the special PCS-31 cable that go to the footswitches are both mono plugs. The footswitch to which you connect the one with the white stripe becomes FOOT 1, while the one with the red stripe goes to FOOT 2.

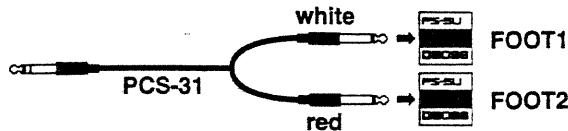

If you use an ordinary cable to connect a footswitch, the pedal functions as FOOT 1.

[Assigning Functions to Footswitches]

- (1) Select the Utility mode.

Press [UTIL] (the pad at the farthest right on the top row of key pads) while holding down [SHIFT ERASE] and confirm that "UTILITY" appears at the top of the display.

- (2) Switch the page using [<]/[>], and confirm that "Foot1" or "Foot2" appears in the display.

* FOOT 1 and FOOT 2 correspond respectively to the L and R channels of the stereo jack.

- (3) Select the action you wish to obtain with each foot switch using the TEMPO/DATA knob.

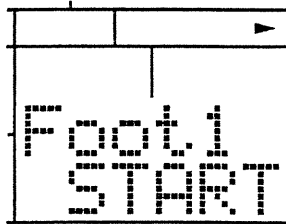

Assignable function and display are as follows:

Display	Function	Display	Function	Display	Function
S/S	alternates Start and Stop	START	Start Key	PAD A	Key Pad A (the Open String Key Pad of top row)
DATA+	increment data value by +1	STOP	Stop Key	PAD B	Key Pad B (the Open String Key Pad of second row)
DATA-	decrement data value by -1	RESET	Reset Key	PAD C	Key Pad C (the Open String Key Pad of third row)
PTN+	increment Pattern Number by +1	FWD	Forward Key	PAD D	Key Pad D (the Open String Key Pad of fourth row)
PTN-	decrement Pattern Number by -1	BWD	Backward Key	PAD E	Key Pad E (the Open String Key Pad of fifth row)
KIT+	increment Kit Number by +1	ENTER	Enter Key	PAD F	Key Pad F (the Open String Key Pad of bottom row)
KIT-	decrement Kit Number by -1	EXIT	Exit Key	PAD00	Key Pad 00 (1st row of the Key Pads)
FRET+	increment Fret Number by +1	CUR>	Cursor Key >	PAD01	Key Pad 01 (1st row of the Key Pads)
FRET-	decrement Fret Number by -1	CUR<	Cursor Key <	PAD02	Key Pad 02 (1st row of the Key Pads)
ACC3	add the accent of the Accent 3	REAL	Realtime/Step Write Key	PAD03	Key Pad 03 (1st row of the Key Pads)
		TIE	Tie Key	PAD04	Key Pad 04 (1st row of the Key Pads)
		TEMPO	Tempo Key	PAD05	Key Pad 05 (2nd row of the Key Pads)
		REPEAT	Repeat Key	PAD06	Key Pad 06 (2nd row of the Key Pads)
		CHORD	Chord ON/OFF Key	PAD07	Key Pad 07 (2nd row of the Key Pads)
		CHOTYP	Chord Type Assign Key	PAD08	Key Pad 08 (2nd row of the Key Pads)
		CHOVAR	Chord Variation Assign Key	PAD09	Key Pad 09 (2nd row of the Key Pads)
		KIT	Kit Key	PAD10	Key Pad 10 (3rd row of the Key Pads)
		TRKSEL	Track Select Key	PAD11	Key Pad 11 (3rd row of the Key Pads)
		SHIFT	Shift/Erase Key	PAD12	Key Pad 12 (3rd row of the Key Pads)
		FRET>	Fret Shift Key >	PAD13	Key Pad 13 (3rd row of the Key Pads)
		FRET<	Fret Shift Key <	PAD14	Key Pad 14 (3rd row of the Key Pads)
		ACC1	Accent Key 1	PAD15	Key Pad 15 (4th row of the Key Pads)
		ACC2	Accent Key 2	PAD16	Key Pad 16 (4th row of the Key Pads)
		TENUTO	Tenuto Key	PAD17	Key Pad 17 (4th row of the Key Pads)
		STACC	Staccato Key	PAD18	Key Pad 18 (4th row of the Key Pads)
				PAD19	Key Pad 19 (4th row of the Key Pads)
				PAD20	Key Pad 20 (5th row of the Key Pads)
				PAD21	Key Pad 21 (5th row of the Key Pads)
				PAD22	Key Pad 22 (5th row of the Key Pads)
				PAD23	Key Pad 23 (5th row of the Key Pads)
				PAD24	Key Pad 24 (5th row of the Key Pads)
				PAD25	Key Pad 25 (6th row of the Key Pads)
				PAD26	Key Pad 26 (6th row of the Key Pads)
				PAD27	Key Pad 27 (6th row of the Key Pads)
				PAD28	Key Pad 28 (6th row of the Key Pads)
				PAD29	Key Pad 29 (6th row of the Key Pads)

(2) Adjusts the Amount of Fret Shift

Follow the steps below to set the amount of fret shift when pressing [<] FRET [>] (p. 1-11).

- (1) Select the Utility mode.
Press [UTIL] while holding down [SHIFT ERASE] and confirm that "UTILITY" appears at the top of the display.
- (2) Switch the page using [<]/[>], and confirm that "FrtStt" appears in the lower-right part of the display.
- (3) Set the amount of fret shift using the TEMPO/DATA knob..

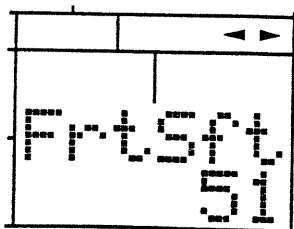

(3) Checking the Amount of Remaining Memory

This utility feature allows you to see how much memory is remaining for Patterns and Songs (how many more you will be able to store).

* *Editing cannot be carried out — the information is for display only.*

- (1) Select the Utility mode.

Press [UTIL] while holding down [SHIFT ERASE] and confirm that "UTILITY" appears at the top of the display.

- (2) Switch the page using [<|>], and confirm that "Avail" appears at the lower-right part of the display.

"P" stands for Pattern, "S" stands for Song. The display for the amount of remaining memory is shown as "%."

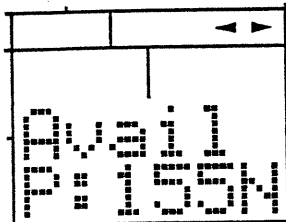

* *About Pattern Memory: Under normal operating conditions, you should be able to store up to about 5,000 notes worth of information for all patterns combined. However, this total could be less, depending on the types of patterns that have been created.*

* *About Song Memory: When your Songs have been created through using only User Patterns, you should be able to store the data for 2,000 Parts for all Songs combined. However, this total number of Parts will be reduced if you have used repeats and/or Preset Patterns.*

(4) Erasure of All Patterns

Carry out the following to erase all the Patterns that have been stored in memory.

- (1) Select the Utility mode.

Press [UTIL] (the pad at the farthest right on the top row of key pads) while holding down [SHIFT ERASE] and confirm that "UTILITY" appears at the top of the display.

- (2) Switch the page using [<|>], and confirm that "AllPtnClear?" appears in the lower-right part of the display.

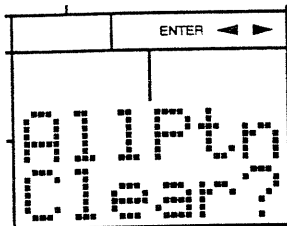

- (3) Press [ENTER]. The confirmation message "Sure?" is shown.

- (4) To proceed with the Pattern Clear, press [ENTER].

To cancel the procedure, press [EXIT].

(5) Erasure of All Songs

Carry out the following to erase the contents of all Songs that have been stored in memory.

- (1) Select the Utility mode.

Press [UTIL] (the pad at the farthest right on the top row of key pads) while holding down [SHIFT ERASE] and confirm that "UTILITY" appears at the top of the display.

- (2) Switch the page using [<]/[>], and confirm that "AllSng Clear?" appears in the lower-right part of the display.

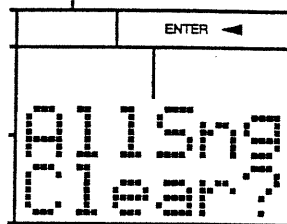

- (3) Press [ENTER]. The message "Sure?" appears, asking you to confirm that you really want to erase all the songs.
- (4) To proceed with the Song Clear, press [ENTER].
To cancel the procedure, press [EXIT].

Chapter 11

Reference

(1) Restoring the Unit's Factory Settings *(Initialization)*

Carry out the procedure below to have all data in the DR-5 be restored to the original factory settings.

(1) First, turn the power OFF.

** Set the volume on all connected devices to "0."*

(2) Turn power ON while you have both of the fret keys ([<]FRET[>]) held down.
"SystemInit?" will be shown in the display.

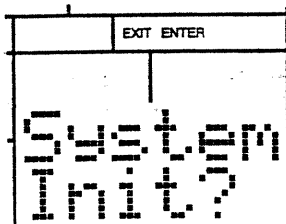

(3) Press [ENTER].

"Sure?" will be displayed.

(4) To go ahead and perform the initialization, press [ENTER].

To cancel the procedure, press [EXIT].

(2) Error Messages

When a mistake in an operational procedure has been made, or the unit is unable to carry out a procedure properly, an Error Message will be shown in the display. In such cases, refer to the information below, then carry out the indicated solution.

* **When an error message continues to be displayed for an extended interval, press [EXIT]. You are returned to what was displayed originally.**

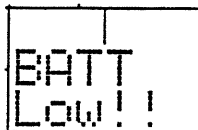

BATT
Low!!

Cause: The battery needed for memory backup (contained inside the unit) has become depleted. (Note that this error message is also displayed when power is turned on.)

Solution: Consult with your retailer or nearest Roland Service Station, and have the battery (essential for memory backup) replaced.

Note: This battery is different than the 6 AA batteries which power the DR-5.

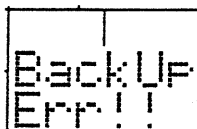

BackUp
Err!!

Cause: Data stored in the DR-5 has been corrupted.

Solution: Press [ENTER] and the unit will be initialized. (All settings will be reset to at their default values.) At the earliest convenience, consult with your retailer or nearest Roland Service Station, and have the battery used for memory backup replaced.

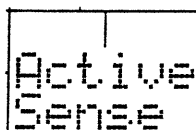

Active
Sense

Cause: An active sensing error was detected. (After the error has been shown briefly, you are automatically returned to what was displayed before.)

Solution: Make sure all MIDI connections are correct and secure.

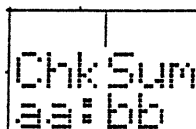

ChkSum
aa:bb

Cause: An incorrect checksum was received during reception of Exclusive messages. (aa is the correct checksum, bb indicates the checksum received.)

Solution: Check the data that was transmitted to determine what the problem was.

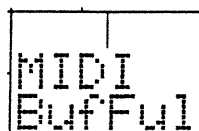

MIDI
BufFull

Cause: An excessive amount of MIDI data was transferred all at once.

Solution: Reduce the amount of data that is to be handled at one time, and repeat the transmission/reception.

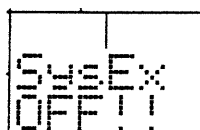

SysEx
OFF!!

Cause: The System Exclusive Device ID Number was set to OFF, therefore Exclusive messages could not be transmitted.

Solution: Set the Device ID Number for System Exclusive to something other than OFF.

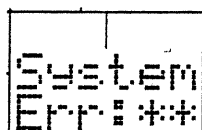

System
Err:***

Cause: A System error occurred in the DR-5.

Solution: If this error appears repeatedly, consult your retailer or the nearest Roland Service Station.

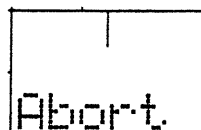

Abort

Cause: A procedure had to be canceled because something was in error, such as when an incorrect parameter has been specified.

(After being displayed briefly you are automatically returned to what was displayed originally.)

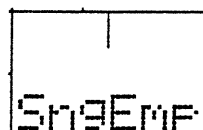

SongEMF

Cause: There is no Song data at the copy source. (After being displayed briefly you are automatically returned to what was displayed originally.)

External MIDI Device Cannot Be Sounded/Cannot Be Used To Sound This Unit.

Cause: Do you have the MIDI channels matched? (p. 9-9)
Do you have the Note Numbers matched? (p. 9-8)

When the DR-5 Is Played Using Performance Data From a Sequencer, a Song on the DR-5 Starts at the Same Time.

Cause: Do you possibly have the Sync mode set to MIDI Sync? (p. 9-11)

The Metronome Does Not Sound.

Cause: Do you possibly have the volume for the metronome set to 0? (p. 3-11)

Program Change Transmission/Reception Unsuccessful

Cause: Could "Prog" for the MIDI mode possibly be set to OFF? (p. 9-9)

MIDI Volume Data Does Not Alter the Volume.

Cause: Could "Volume" for the MIDI mode possibly be set to OFF? (p. 9-10)

MIDI Expression Data Does Not Alter the Volume.

Cause: Could "Expr" for the MIDI mode possibly be set to OFF? (p. 9-10)

Your Setting for Track Level in a Song Does Not Alter the Volume.

Cause: Could "Expr" for the MIDI mode possibly be set to OFF? (p. 9-10)

Exclusive Messages Not Received.

Cause: Could "SysEx" for the MIDI mode possibly be set to OFF? (p. 9-10)
Do the System Exclusive Device ID Numbers match? (p. 9-10)

The DR-5 is not in tune with the other instrument/device.

Cause: Could the Master Tune setting (p. 8-5) be incorrect?

(4) Factory Preset Kit Settings

KIT No.	Prog. Chg.No.	KIT NAME	Track1	Track2	Track3	Rhythm Kit Name
P00	65	Heavy (Heavy)	HevyGt	FngBs1	HevyGt	
P01	66	Arena (Arena)	Organ1	PickBs	FdbkGt	
P02	67	Fx (Fx)	Sound	SynBs2	Sitar	
P03	68	Hybrid (Hybrid)	Clav	SynBs1	Sin	
P04	69	Ballad (Ballad)	Piano2	FngBs1	Strin1	
P05	70	Studio (Studio)	Piano2	FngBs2	Brass3	
P06	71	Dance 1 (Dance1)	EPian1	SynBs2	Organ3	
P07	72	Dance 2 (Dance2)	Strin1	SynBs5	PopGt	
P08	73	Dance 3 (Dance3)	Organ1	SynBs2	Flute	
P09	74	Country 1 (Count1)	Honky	FngBs1	StlGt1	
P10	75	Country 2 (Count2)	Banjo	FngBs2	StlGt1	
P11	76	Rock 1 (Rock 1)	Poly	SlpBs1	Square	
P12	77	Rock 2 (Rock 2)	Epian2	SlpBs2	FnkGt1	
P13	78	Rocker (Rocker)	OvrGt2	SlpBs2	Feedbk	Room
P14	79	Mixture (Mixtur)	12 Gt2	PickBs	MutGt1	Power
P15	80	Live (Live)	OvrGt1	PickBs	StlGt1	Heavy
P16	81	House (House)	Saw	SynBs4	MutGt2	
P17	82	Club (Club)	Epian2	FngBs1	Warm	
P18	83	Funk 1 (Funk 1)	Saw	FngBs1	StlGt1	Dance 1
P19	84	Funk 2 (Funk 2)	Piano2	SynBs1	Brass1	Dance 2
P20	85	Funny (Funny)	Sound	FretBs	Warm	Latin
P21	86	Pop 1 (Pop 1)	Pizz	SynBs3	Orches	Electronic
P22	87	Pop 2 (Pop 2)	Piano2	SynBs1	Poly	TR-808
P23	88	Pop 3 (Pop 3)	Vibe	AcoBs1	MuteTp	Brush
P24	89	Pop 4 (Pop 4)	Organ4	FngBs1	Strin1	Orchestra
P25	90	Blues 1 (Blues1)	Piano1	FngBs1	Harmo	Standard
P26	91	Blues 2 (Blues2)	Epiano1	AcoBs1	Tensax	Jazz
P27	92	'70s ('70s)	Organ1	FngBs2	DistGt	
P28	93	Dry (Dry)	Accord	FretBs	NylGt1	
P29	94	Ambient (Ambo)	Violin	AcoBs2	NylGt1	
P30	95	R&B 1 (R&B 1)	Brass2	FngBs1	FnkGt2	
P31	96	R&B 2 (R&B 2)	Piano1	AcoBs2	Brass1	
P32(U00)	97(105)	Acoustic 1(Acous1)	Mandol	Contra	12 Gt1	Studio
P33(U01)	98(106)	Acoustic 2(Acous2)	Strin2	FretBs	StlGt2	R&B 2
P34(U02)	99(107)	Ensemble (Ensemb)	SopSax	Contra	Oboe	Arena
P35(U03)	100(108)	Resort (Resort)	Ukulel	FngBs1	HawaGt	Reggae
P36(U04)	101(109)	World (World)	Organ4	SlpBs1	Fantas	
P37(U05)	102(110)	Reggae (Reggae)	Stldr	FngBs1	ClnGt	
P38(U06)	103(111)	Percussion (Perc)	Vibe	AcoBs2	Marimb	
P39(U07)	104(112)	Latin (Latin)	Piano2	FngBs2	Organ2	
P40(U08)	1(113)	Standard (Stndrd)	Piano1	SlpBs4	Brass1	
P41(U09)	9(114)	Room (Room)	Epiano1	SlpBs1	OvrGt1	
P42(U10)	17(115)	Power (Power)	Organ3	SlpBs5	FdbkGt	
P43(U11)	25(116)	Electronic (Electr)	Saw	SynBs2	Choir	
P44(U12)	26(117)	TR-808 (TR-808)	Strin2	SynBs5	Trumpt	
P45(U13)	33(118)	Jazz (Jazz)	Piano1	AcoBs1	JazzGt	
P46(U14)	41(119)	Brush (Brush)	Piano1	FretBs	Clarín	
P47(U15)	49(120)	Orchestra (Orches)	Strin1	Brass1	Timpan	

[Kit Parameter]

Kit # : _____ Kit Name : _____

Drums

Pad#	Note#	Instrument	Volume	Pitch	Decay	Pan
00						
01						
02						
03						
04						
05						
06						
07						
08						
09						
10						
11						
12						
13						
14						
15						
16						
17						
18						
19						
20						
21						
22						
23						
24						
25						
26						
27						
28						
29						

Tracks 1 — 3

Pad#	Oct Shift	Instrument	Volume	Decay	Pan
Track 1					
Track 2					
Track 3					

Example)

[Kit Parameter]

Kit # : P40 Kit Name : Stndrd

Drums

Pad#	Note#	Instrument	Volume	Pitch	Decay	Pan
00	82	Shaker	15	0	0	R5
01	60	BongoH	15	0	0	L3
02	61	BongoL	15	0	0	L3
03	80	TriMt	15	0	0	L2
04	81	TriOp	15	0	0	L2
05	58	Vibslp	15	0	0	R4
06	75	Claves	15	0	0	L2
07	54	Tambrn	15	0	0	L2
08	76	WodBlk	15	0	0	L4
09	77	Wodblk	15	-50	0	L4
10	55	SplshC	15	0	0	C
11	49	CrshC1	15	0	0	L3
12	57	CrshC2	15	0	0	R2
13	53	RidBIC	15	0	0	R3
14	51	RideC	15	0	0	R3
15	37	AmbStk	15	0	0	L1
16	50	DublT1	15	0	0	L5
17	48	DublT2	15	0	0	L1
18	45	DublT3	15	0	0	R1
19	41	DublT4	15	0	0	R5
20	35	Hard K	15	0	0	C
21	40	Reals2	15	0	0	C
22	42	PopCHH	15	0	0	L3
23	26	PopOHH	15	0	-14	L3
24	46	PopOHH	15	0	3	L3
25	36	Dry K	15	0	0	C
26	38	Fat S	15	0	0	C
27	44	PopPHH	15	0	0	L3
28	56	Cowbel	15	0	0	L1
29	39	808Clp	15	0	0	C

Tracks 1 — 3

Pad#	Oct Shift	Instrument	Volume	Decay	Pan
Track 1	0	Piano1	12	0	L3
Track 2	-1	SlpBs4	15	0	C
Track 3	0	Brass1	11	0	R3

ROLAND EXCLUSIVE MESSAGES

1. Data Format for Exclusive Messages

Roland's MIDI implementation uses the following data format for all Exclusive messages (type IV):

Byte	Description
F0H	Exclusive Status
41H	Manufacturer ID (Roland)
DEV	Device ID
MDL	Model ID
CMD	Command ID
[BODY]	Main data
F7H	End of exclusive

•MIDI status: F0H, F7H

An Exclusive message must be flanked by a pair of status codes, starting with a Manufacturer ID immediately after F0H (MIDI version 1.0).

•Manufacturer ID: 41H

The Manufacturer ID identifies the manufacturer of a MIDI instrument that sends an Exclusive message. Value 41H represents Roland's Manufacturer ID.

•Device ID: DEV

The Device ID contains a unique value that identifies individual devices in the implementation of several MIDI instruments. It is usually set to 00H-0FH, a value smaller by one than that of a basic channel, but value 00H-1FH may be used for a device with several basic channels.

•Model ID: MDL

The Model ID contains a value that identifies one model from another. Different models, however, may share an identical Model ID if they handle similar data.

The Model ID format may contain 00H in one or more places to provide an extended data field. The following are examples of valid Model IDs, each representing a unique model:

01H
02H
03H
00H, 01H
00H, 02H
00H, 00H, 01H

•Command ID: CMD

The Command ID indicates the function of an Exclusive message. The Command ID format may contain 00H in one or more places to provide an extended data field. The following are examples of valid Command IDs, each representing a unique function:

01H
02H
03H
00H, 01H
00H, 02H
00H, 00H, 01H

•Main data: BODY

This field contains a message to be exchanged across an interface. The exact data size and content will vary with the Model ID and Command ID.

2. Address-mapped Data Transfer

Address mapping is a technique for transferring messages conforming to the data format given in Section 1. It assigns a series of memory-resident records—waveform and tone data, switch status, and parameters, for example, to specific locations in a machine-dependent address space, thereby allowing access to data residing at the address a message specifies.

Address-mapped data transfer is therefore independent of models and data categories. This technique allows use of two different transfer procedures: one-way transfer and handshake transfer.

•One-way transfer procedure (See Section 3 for details.)

This procedure is suited to the transfer of a small amount of data. It sends out an Exclusive message completely independent of the receiving device's status.

Connection Diagram

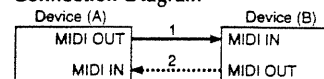

Connection at point 2 is essential for "Request data" procedures. (See Section 3.)

•Handshake-transfer procedure

(This device does not use this procedure)

This procedure initiates a predetermined transfer sequence (handshaking) across the interface before data transfer takes place. Handshaking ensures that reliability and transfer speed are high enough to handle a large amount of data.

Connection Diagram

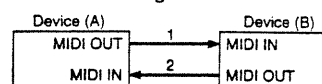

Connection at points 1 and 2 is essential.

Notes on the above procedures

- There are separate Command IDs for different transfer procedures.
- Devices A and B cannot exchange data unless they use the same transfer procedure, share identical Device ID and Model ID, and are ready for communication.

3. One-way Transfer Procedure

This procedure sends out data until it has all been sent and is used when the messages are so short that answerbacks need not be checked.

For longer messages, however, the receiving device must acquire each message in time with the transfer sequence, which inserts 20 milliseconds intervals.

Types of Messages

Message	Command ID
Request data 1	RQ1 (11H)
Data set 1	DT1 (12H)

• Request data #1: RQ1 (11H)

This message is sent out when there is a need to acquire data from a device at the other end of the interface. It contains data for the address and size that specify designation and length, respectively, of data required.

On receiving an RQ1 message, the remote device checks its memory for the data address and size that satisfy the request. If it finds them and is ready for communication, the device will transmit a "Data set 1 (DT1)" message, which contains the requested data. Otherwise, the device won't send out anything.

Byte	Description
FOH	Exclusive Status
41H	Manufacturer ID (Roland)
DEV	Device ID
MDL	Model ID
11H	Command ID
aaH	Address MSB
	LSB
ssH	Size MSB
	LSB
sum	Check sum
F7H	End of exclusive

- * The size of the requested data does not indicate the number of bytes that will make up a DT1 message, but represents the address fields where the requested data resides.
- * Some models are subject to limitations in data format used for a single transaction. Requested data, for example, may have a limit in length or must be divided into predetermined address fields before it is exchanged across the interface.
- * The same number of bytes comprises address and size data, which, however, vary with the Model ID.
- * The error-checking process uses a checksum that provides a bit pattern where the last 7 bits are zero when values for an address, size, and that checksum are summed.

• Data set 1: DT1 (12H)

This message corresponds to the actual data transfer process. Because every byte in the data is assigned a unique address, a DT1 message can convey the starting address of one or more bits of data as well as a series of data formatted in an address-dependent order.

The MIDI standards inhibit non real-time messages from interrupting an Exclusive one. This fact is inconvenient for devices that support a "soft-thru" function. To maintain compatibility with such devices, Roland has limited the DT1 to 256 bytes so that an excessively long message is sent out in separate 'segments'.

Byte	Description
FOH	Exclusive Status
41H	Manufacturer ID (Roland)
DEV	Device ID
MDL	Model ID
12H	Command ID
aaH	Address MSB
	LSB
ddH	Data MSB
	LSB
sum	Check sum
F7H	End of exclusive

- * A DT1 message is capable of providing only the valid data among those specified by an RQ1 message.
- * Some models are subject to limitations in data format used for a single transaction. Requested data, for example, may have a limit in length or must be divided into predetermined address fields before it is exchanged across the interface.
- * The number of bytes comprising address data varies from one Model ID to another.
- * The error-checking process uses a checksum that provides a bit pattern where the last 7 bits are zero when values for an address, size, and that checksum are summed.

• Example of Message Transactions

- Device A sending data to Device B

Transfer of a DT1 message is all that takes place.

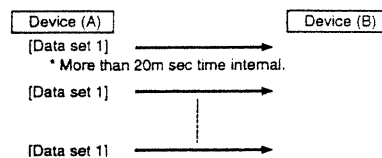

- Device B requesting data from Device A

Device B sends an RQ1 message to Device A. Checking the message, Device A sends a DT1 message back to Device B.

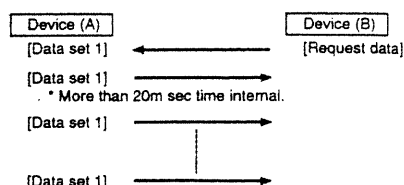

1. TRANSMITTED DATA

• Channel Voice Message

Note Off

<u>Status</u> 9nH	<u>Second</u> kkH	<u>Third</u> 00H
n = MIDI channel		:0H - FH (ch.1 - ch.16)
kk = Note number		:0H - 7FH (0 - 127)

Note On

<u>Status</u> 9nH	<u>Second</u> kkH	<u>Third</u> vvH
n = MIDI channel		:0H - FH (ch.1 - ch.16)
kk = Note number		:0H - 7FH (0 - 127)
vv = Velocity		:01H - 7FH (1 - 127)

Transmitted at channel of each track.

Controll Change

Expression

<u>Status</u> BnH	<u>Second</u> 0BH	<u>Third</u> vvH
n = MIDI channel		:0H - FH (ch.1 - ch.16)
vv = Expression		:00H - 7FH (0 - 127)

This message is transmitted if the TRACK LEVEL status is set in the song when the "expression switch" of the MIDI parameter is set at ON.

Program Change

<u>Status</u> CnH	<u>Second</u> ppH	
n = MIDI channel		:0H - FH (ch.1 - ch.16)
pp = program number		:00H - 77H (prog.1 - prog.120)

If the kits are changed, this message is transmitted at channel of DRUM TRACK when the "program change switch" of the MIDI parameter is set at ON. The transmitted program numbers are following.

kit	pp	kit	pp
Heavy	40H (65)	Acoustic 1	60H (97)
Arena	41H (66)	Acoustic 2	61H (98)
Fx	42H (67)	Ensemble	62H (99)
Hybrid	43H (68)	Resort	63H (100)
Ballad	44H (69)	World	64H (101)
Studio	45H (70)	Reggae	65H (102)
Dance 1	46H (71)	Percussion	66H (103)
Dance 2	47H (72)	Latin	67H (104)
Dance 3	48H (73)	Standard	00H (1)
Country 1	49H (74)	Room	08H (9)
Country 2	4AH (75)	Power	10H (17)
Rock 1	4BH (76)	Electronic	18H (25)
Rock 2	4CH (77)	TR-808	19H (26)
Rocker	4DH (78)	Jazz	20H (33)
Mixture	4EH (79)	Brush	28H (41)
Live	4FH (80)	Orchestra	30H (49)
House	50H (81)	user kit 0	68H (105)
Club	51H (82)	user kit 1	69H (106)
Funk 1	52H (83)	user kit 2	6AH (107)
Funk 2	53H (84)	user kit 3	6BH (108)
Funny	54H (85)	user kit 4	6CH (109)
Pop 1	55H (86)	user kit 5	6DH (110)
Pop 2	56H (87)	user kit 6	6EH (111)
Pop 3	57H (88)	user kit 7	6FH (112)
Pop 4	58H (89)	user kit 8	70H (113)
Blues 1	59H (90)	user kit 9	71H (114)
Blues 2	5AH (91)	user kit 10	72H (115)
'70s	5BH (92)	user kit 11	73H (116)
Dry	5CH (93)	user kit 12	74H (117)
Ambient	5DH (94)	user kit 13	75H (118)
R&B 1	5EH (95)	user kit 14	76H (119)
R&B 2	5FH (96)	user kit 15	77H (120)

Pitch Bend Change

If the "External Pitch" is set at ON, this message is transmitted at channel of selected track depending on the condition of the guitar input. In real time pattern write mode(including "stand-by"), this message is never transmitted.

<u>Status</u> EnH	<u>Second</u> llH	<u>Third</u> mmH
n = MIDI channel		:0H - FH (ch.1 - ch.16)
mm, ll = Pitch Bend value		:00H,00H - 40H,00H - 7FH,7FH(-8192 - 0 - +8191)

• System Exclusive Message

<u>Status</u> F0H	: System Exclusive
F7H	: EOXAi End Of Exclusive Aj

With the DR-5, the System Exclusive Messages can be used to transmit Bulk Dump of kit parameters, system set up, sequence data, user chord data. For details refer to "3. Exclusive Communications" and "Roland Exclusive Messages".

• System Common Message

If the "Sync" of the MIDI parameter is set at "MIDI", this message is never transmitted.

Song Position Pointer

<u>Status</u> F2H	<u>Second</u> mmH	<u>Third</u> llH
ll, mm = Song Position		:00H,00H - 7FH,7FH (0 - 16383)

Transmitted in one of the following operations:

- When the song play mode has been selected.
 - When the song has been selected in the song play mode.
 - Measure reposition or measure selection has been done in the song play mode
- Besides, if the RESET key has been pressed when the DR-5 is in stop, song position 00H, 00H is transmitted.

Song Select

<u>Status</u> F3H	<u>Second</u> ssH
ss = Song number	:00H - 13H (0 - 19)

Transmitted in one of the following operations:

- When the song play mode has been selected.
- When the song has been selected in the song play mode.

• System Real Time Message

If the "Sync" of the MIDI parameter is set at "MIDI", this message is never transmitted.

Timing Clock

<u>Status</u> F8H

If the "Sync" of the MIDI parameter is set at "INTERNAL", this message is transmitted even when the DR-5 is in stop.

Start

<u>Status</u> FAH

Continue

<u>Status</u> FBH

Stop

<u>Status</u> FCH

Active Sensing

Status
FEH

Transmitted for checking MIDI connections between the DR-5 and external equipment.

2. RECOGNIZED DATA

Only Note On and Note Off messages can be recorded in the sequencer.

• Channel Voice Message

Note Off

Status	Second	Third
8nH	kkH	vvH
9nH	kkH	00H

n = MIDI channel :0H - FH (ch.1 - ch.16)
kk = Note number :00H - 7FH (0 - 127)
vv = Velocity :00H - 7FH (0 - 127)

The Velocity is always ignored.

This message received on the channel of DRUM TRACK is ignored.

On the channel of TRACK 1-3, only Note number:33 - 96 can be recognized in real time pattern write mode(including "stand-by").

Note On

Status	Second	Third
9nH	kkH	vvH

n = MIDI channel :0H - FH (ch.1 - ch.16)
kk = Note number :00H - 7FH (0 - 127)
vv = Velocity :01H - 7FH (1 - 127)

On the channel of TRACK 1-3, only Note number:33 - 96 can be recognized in real time pattern write mode(including "stand-by").

Control Change

Modulation

Status	Second	Third
BnH	01H	vvH

n = MIDI channel :0H - FH (ch.1 - ch.16)
vv = Modulation depth :00H - 7FH (0 - 127)

Ignored in real time pattern write mode(including "stand-by").

Data Entry

Status	Second	Third
BnH	06H	mmH
BnH	26H	llH

n = MIDI channel :0H - FH (ch.1 - ch.16)
mm = MSB value of the parameter specified by RPN
ll = LSB value of the parameter specified by RPN

Volume

Status	Second	Third
BnH	07H	vvH

n = MIDI channel :0H - FH (ch.1 - ch.16)
vv = Volume :00H - 7FH (0 - 127)

If the "Volume switch" of the MIDI parameter is set at ON, this message is recognized on the channel of each track.
Real volume is determined by (Volume value) x (Expression value).

Panpot

Status	Second	Third
BnH	0AH	vvH

n = MIDI channel :0H - FH (ch.1 - ch.16)
vv = Panpot :00H - 40H - 7FH (0,1 - 64 - 127)

0,1 means Left, 64 means Center, 127 means Right. 127 steps in total can be set.
Panpot of the instrument corresponds to the received MIDI channel is changed relatively as the received value.

Expression

Status	Second	Third
BnH	0BH	vvH

n = MIDI channel :0H - FH (ch.1 - ch.16)
vv = Expression :00H - 7FH (0 - 127)

If the "Expression switch" of the MIDI parameter is set at ON, this message is recognized on the channel of each track.
Real volume is determined by (Volume value) x (Expression value).

Hold1

Status	Second	Third
BnH	40H	vvH

n = MIDI channel :0H - FH (ch.1 - ch.16)
vv = Control value:00H - 7FH (0 - 127)

0-63 means OFF, 64-127 means ON.

Ignored in real time pattern write mode(including "stand-by").

RPN MSB/LSB

Status	Second	Third
BnH	65H	mmH
BnH	64H	llH

n = MIDI channel :0H - FH (ch.1 - ch.16)
mm = MSB of parameter specified by RPN
ll = LSB of parameter specified by RPN

There is no change in parameter values via RPN by receiving Program Change.

RPN

RPN(Registered Parameter Number) is the expanded Control Change message defined by the MIDI standard.

RPN MSB/LSB should be set before sending data entry.

The DR-5 recognizes following RPN.

RPN	Data entry	Description
00H 00H	mmH —	Pitch Bend Sensitivity mm: 00H-1BH (0 - 24 semitones) Up to 2 octaves, default setting is 2 semitones. This setting becomes effective for subsequent Pitch Bend messages.
00H 01H	mmH llH	Master Fine Tuning mm,ll: 00H,00H-40H,00H-7FH,7FH (-8192*100/8192 - 0 - +8191*100/8192 cent)
7FH 7FH	— —	RPN reset. No specified parameter is assigned to RPN and NRPN. Current value is not affected.

<How to use RPN>

Hexadecimal representation is used in following examples.

(1)Specify the parameter to RPN.

Bn 65 mm (Bn) 64 ll
^^ ^^
mm : MSB of parameter number
ll : LSB of parameter number

(2)Set parameter value using data entry.

(Bn) 06 vm (Bn) 26 vl
^^ ^^
vm: MSB of parameter value
vl: LSB of parameter value

Sending only the MSB value is possible, if the required resolution of the value is 128 steps.
Omitting the MSB value is allowed, if the required range of the value is less than 128.

(3) Reset RPN(No parameter specified by RPN)

(Bn) 65 7F (Bn) 64 7F

Once the parameter is specified by RPN, all values sent by data entry are valid. It is recommended to reset RPN after sending the value so as to avoid any problems.

Program Change

Status Second
CnH ppH

n = MIDI channel :0H - FH (ch.1 - ch.16)
pp = Program number :00H - 7FH (prog.1 - prog.120)

If the "Program Change switch" of the MIDI parameter is set at ON, this message is recognized.
Kits are changed by receiving Program Change on the channel of DRUM TRACK.

pp	kit	pp	kit
00H (1)	Standard	40H (65)	Heavy
01H (2)	Standard	41H (66)	Arena
02H (3)	Standard	42H (67)	Fx
03H (4)	Standard	43H (68)	Hybrid
04H (5)	Standard	44H (69)	Ballad
05H (6)	Standard	45H (70)	Studio
06H (7)	Standard	46H (71)	Dance 1
07H (8)	Standard	47H (72)	Dance 2
08H (9)	Room	48H (73)	Dance 3
09H (10)	Room	49H (74)	Country 1
0AH (11)	Room	4AH (75)	Country 2
0BH (12)	Room	4BH (76)	Rock 1
0CH (13)	Room	4CH (77)	Rock 2
0DH (14)	Room	4DH (78)	Rocker
0EH (15)	Room	4EH (79)	Mixture
0FH (16)	Room	4FH (80)	Live
10H (17)	Power	50H (81)	House
11H (18)	Power	51H (82)	Club
12H (19)	Power	52H (83)	Funk 1
13H (20)	Power	53H (84)	Funk 2
14H (21)	Power	54H (85)	Funny
15H (22)	Power	55H (86)	Pop 1
16H (23)	Power	56H (87)	Pop 2
17H (24)	Power	57H (88)	Pop 3
18H (25)	Electronic	58H (89)	Pop 4
19H (26)	TR-808	59H (90)	Blues 1
1AH (27)	Electronic	5AH (91)	Blues 2
1BH (28)	Electronic	5BH (92)	'70s
1CH (29)	Electronic	5CH (93)	Dry
1DH (30)	Electronic	5DH (94)	Ambient
1EH (31)	Electronic	5EH (95)	R&B 1
1FH (32)	Electronic	5FH (96)	R&B 2
20H (33)	Jazz	60H (97)	Acoustic 1
21H (34)	Jazz	61H (98)	Acoustic 2
22H (35)	Jazz	62H (99)	Ensemble
23H (36)	Jazz	63H (100)	Resort
24H (37)	Jazz	64H (101)	World
25H (38)	Jazz	65H (102)	Reggae
26H (39)	Jazz	66H (103)	Percussion
27H (40)	Jazz	67H (104)	Latin
28H (41)	Brush	68H (105)	user kit 0
29H (42)	Brush	69H (106)	user kit 1
2AH (43)	Brush	6AH (107)	user kit 2
2BH (44)	Brush	6BH (108)	user kit 3
2CH (45)	Brush	6CH (109)	user kit 4
2DH (46)	Brush	6DH (110)	user kit 5
2EH (47)	Brush	6EH (111)	user kit 6
2FH (48)	Brush	6FH (112)	user kit 7
30H (49)	Orchestra	70H (113)	user kit 8
31H (50)	Orchestra	71H (114)	user kit 9
32H (51)	Orchestra	72H (115)	user kit 10
33H (52)	Orchestra	73H (116)	user kit 11
34H (53)	Orchestra	74H (117)	user kit 12
35H (54)	Orchestra	75H (118)	user kit 13
36H (55)	Orchestra	76H (119)	user kit 14
37H (56)	Orchestra	77H (120)	user kit 15
38H (57)	Orchestra		
39H (58)	Orchestra		
3AH (59)	Orchestra		
3BH (60)	Orchestra		
3CH (61)	Orchestra		
3DH (62)	Orchestra		
3EH (63)	Orchestra		
3FH (64)	Orchestra		

Instruments of the selected kit can be used for subsequent Note On messages.

Pitch Bend Change

Ignored in real time pattern write mode (including "stand-by").

Status Second Third
EnH llH mmH

n = MIDI channel :0H - FH (ch.1 - ch.16)
mm, ll = Pitch bend value :00H, 00H - 40H, 00H - 7FH, 7FH (-8192 - 0 - +8191)

Channel Mode Message

All Sound Off

Status Second Third
BnH 78H 00H

n = MIDI channel :0H - FH (ch.1 - ch.16)

All current active voices in the specified channel will be shut off. However, current mode is not affected.

Reset All Controllers

Status Second Third
BnH 79H 00H

n = MIDI channel :0H - FH (ch.1 - ch.16)

The following control values on the specified channel return to the default values:

Controller	Default Value
Pitch Bend Change	0(center)
Panpot	64
Hold1	0(off)
Modulation	0(min)
Expression	127(max)
Volume	127(max)
RPN	No specified parameter No change in value

All Notes Off

Status Second Third
BnH 7BH 00H

n = MIDI channel :0H - FH (ch.1 - ch.16)

All active voices on the specified channel are turned off. (Each voice responds as to a "Note Off".) If Hold1 is ON, this message does not become effective until Hold1 is OFF. This message on the channel of DRUM TRACK is ignored.

OMNI OFF

Status Second Third
BnH 7CH 00H

n = MIDI channel :0H - FH (ch.1 - ch.16)

OMNI OFF is only recognized as "All Notes Off". Current mode doesn't change. (Always at Mode 3)

OMNI ON

Status Second Third
BnH 7DH 00H

n = MIDI channel :0H - FH (ch.1 - ch.16)

OMNI ON is only recognized as "All Notes Off". Current mode doesn't change. (Always at Mode 3)

MONO

Status Second Third
BnH 7EH mmH

n = MIDI channel :0H - FH (ch.1 - ch.16)
mm = Number of mono :00H - 10H (0 - 16)

MONO is only recognized as "All Notes Off". Current mode doesn't change. (Always at Mode 3)

POLY

Status Second Third
BnH 7FH 00H

n = MIDI channel :0H - FH (ch.1 - ch.16)

POLY is only recognized as "All Notes Off". Current mode doesn't change. (Always at Mode 3)

• System Exclusive Message

Status
 FOH : System Exclusive
 F7H : EOXAi End Of Exclusive A

With the DR-5, the System Exclusive Messages can be used to receive kit parameters, system set up, sequence data, user chord data.
 For details refer to "3. Exclusive Communications" and "Roland Exclusive Messages".

• System Common Message

Recognized only when the DR-5 is in stop and "Sync" of the MIDI parameter is set at MIDI.

Song Position Pointer

Status **Second** **Third**
 F2H mmH lIH
 ll,mm = Song Position :00H,00H - 7FH,7FH (0 - 16383)

If the DR-5 receives Song Position Pointer in song play mode, it calls the position in the song.

If the DR-5 receives Song Position Pointer in pattern play mode or real time write mode, it calls the position in the pattern.

Song Select

Status **Second**
 F3H ssH
 ss = Song number :00H - 13H (0 - 19)

When received in song play mode, it changes the songs.

• System Real time Message

Recognized only when "Sync" of the MIDI parameter is set at MIDI.

Timing Clock

Status
 F8H

Start

Status
 FAH

Continue

Status
 FBH

Stop

Status
 FCH

Active Sensing

Status
 FEH

Whenever the DR-5 receives this message, it monitors the interval of the incoming data. If the subsequent message has not arrived within about 420ms after the previous data, it processes all tracks as though it has received All Sound Off, All Notes Off, Reset All Controllers, and mutes the sounding voices, then stops monitoring receiving interval.

3. Exclusive Communications

• General

DR-5 can do one-way communications to send and receive parameters for kits, system set up, sequence, user chord.

Model ID included in the exclusive message should be 65H. The device ID code should be System Exclusive Device ID of MIDI parameter. Note that the actual value that set in device ID field is smaller by one than the value set at System Exclusive Device ID of MIDI parameter.

• One Way Communications

Request data RQ1 11H

Byte	Description
FOH	Exclusive status
41H	Manufacturer ID (Roland)
DEV	Device ID (00H - 1FH)
65H	Model ID (DR-5)
11H	Command ID (RQ1)
aaH	Address MSB
aaH	Address
aaH	Address LSB
ssH	size MSB
ssH	size
ssH	size LSB
sum	Check sum
F7H	EOX (End of Exclusive)

Data set DT1 12H

Byte	Description
FOH	Exclusive status
41H	Manufacturer ID (Roland)
DEV	Device ID (00H - 1FH)
65H	Model ID (DR-5)
12H	Command ID (DT1)
aaH	Address MSB
aaH	Address
aaH	Address LSB
ddH	Data MSB
ddH	Data LSB
:	:
sum	Check sum
F7H	EOX (End of Exclusive)

• Transmission

The DR-5 transmits Exclusive messages only when MIDI Bulk dump is performed by panel operation in the menu of MIDI mode.

• Receive

The DR-5 receives Exclusive messages only when MIDI Bulk dump is not performed and it is in stop.

4. Parameter Address Map

Addresses are shown in every 7-bit hexadecimal.

Address	MSB	LSB
Binary	0aaa aaaa	0bbb bbbb 0ccc cccc
7-bit hex.	AA	BB CC

• Parameter base addresses

Start Address	Description	
00 00 00	kit parameters	*4-1
:	:	:
10 00 00	system set up	*4-2
:	:	:
20 00 00	sequence data	*4-3
:	:	:
30 00 00	user chord data	*4-4

Table 4-1 Kit parameters

kk:User kit No.(00-0F)
 dd:Pad No.(00-1D)
 tt:Track No.(1E=track1, 1F=track2, 20=track3)

Offset Address	Description
kk 00 ddx2	Inst No. upper (drum part)
kk 00 ddx2+1	Inst No. lower (drum part)
kk 00 ttx2	Inst No. upper (pitch part)
kk 00 ttx2+1	Inst No. lower (pitch part)
kk 01 ddx2	Pitch upper (drum part)
kk 01 ddx2+1	Pitch lower (drum part)
00 00 - 0F 0F (0 - 255)	Use nibblized data (*1)
00 00 - 0F 0F (0 - 255)	Use nibblized data (*1)
03 0A - 0C 06 (-700 - +700(cent))	Use nibblized data (*2)

kk 02 tt	Octave shift (pitch part)	00 - 02 (-1, 0, 1)
kk 03 ddx2	Note No. upper (drum part)	00 00 - 07 0F, 0F 0F (0 - 127, OFF)
kk 03 ddx2+1	Note No. lower (drum part)	Use nibblized data (*1)
kk 04 dd	Level (drum part)	00 - 0F (0 - 15)
kk 04 tt	Level (pitch part)	00 - 0F (0 - 15)
kk 05 dd	Pan (drum part)	00 - 07 - 0E (L7 - C - R7)
kk 05 tt	Pan (pitch part)	00 - 07 - 0E (L7 - C - R7)
kk 06 dd	Decay (drum part)	21 - 40 - 5F (-31 - 0 - +31)
kk 06 tt	Release (pitch part)	21 - 40 - 5F (-31 - 0 - +31)
kk 07 00	Kit name ASCII (left)	20 - 7F (32 - 127)
kk 07 01	Kit name ASCII	20 - 7F (32 - 127)
kk 07 02	Kit name ASCII	20 - 7F (32 - 127)
kk 07 03	Kit name ASCII	20 - 7F (32 - 127)
kk 07 04	Kit name ASCII	20 - 7F (32 - 127)
kk 07 05	Kit name ASCII (right)	20 - 7F (32 - 127)

(*1)
upper x 16 + lower (0 - 255)

(*2)
upper x 16 + lower (-70 - 70{x 10 cent})

(ex.)

upper	lower	true value[cent]
03	0A	-700
05	0D	-350
08	00	0
0A	03	+350
0C	06	+700

Table 4-2 System Set Up parameters

Offset Address	Description
10 00 00	Master tune 00 00 01 08 - 00 07 0E 08
10 00 01	(-100.0 - +100.0 cent)
10 00 02	Use nibblized data (*)
10 00 03	
10 00 04	Drum track MIDI ch 00 - 0F(0 - 15)
10 00 05	Track 1 MIDI ch 00 - 0F(0 - 15)
10 00 06	Track 2 MIDI ch 00 - 0F(0 - 15)
10 00 07	Track 3 MIDI ch 00 - 0F(0 - 15)
10 00 08	Drum track volume 00 - 7F(0 - 127)
10 00 09	Track 1 volume 00 - 7F(0 - 127)
10 00 0A	Track 2 volume 00 - 7F(0 - 127)
10 00 0B	Track 3 volume 00 - 7F(0 - 127)
10 00 0C	Program Change sw 00 - 01(0:OFF 1:ON)
10 00 0D	Volume sw 00 - 01(0:OFF 1:ON)
10 00 0E	Expression sw 00 - 01(0:OFF 1:ON)
10 00 0F	MIDI Through sw 00 - 01(0:OFF 1:ON)
10 00 10	MIDI Sync sw 00 - 01(0:INTERNAL 1:MIDI)
10 00 11	Guitar in sw 00 - 02(0:AMPSIM 1:BYPASS 2:MIXOFF)
10 00 12	External pitch sw 00 - 02(0:OFF 1:ON 2:REC)
10 00 13	Fret shift value 01 - 0C(1 - 12)
10 00 14	Metronome volume 00 - 0F(0 - 15)
10 00 15	Metronome type 00 - 03(1/4, 1/6, 1/8, 1/12)
10 00 16	Foot sw 1 assign aa
10 00 17	Foot sw 2 assign aa

*1) ± 0 [cent] is 00 04 00 00.

aa	Foot sw	aa	Foot sw	aa	Foot sw	aa	Foot sw	aa	Foot sw
00	START/STOP	10	EXIT	20	ACC2	30	PAD07	40	PAD3
01	DATA +1	11	CURSOR >	21	TENUTO	31	PAD08	41	PAD24
02	DATA -1	12	CURSOR <	22	STACC	32	PAD09	42	PAD25
03	PTN +1	13	REC	23	PAD A	33	PAD10	43	PAD26
04	PTN -1	14	TIE	24	PAD B	34	PAD11	44	PAD27
05	KIT +1	15	TEMPO	25	PAD C	35	PAD12	45	PAD28
06	KIT -1	16	REPEAT	26	PAD D	36	PAD13	46	PAD29
07	FRET +1	17	CHORD ON/OFF	27	PAD E	37	PAD14		
08	FRET -1	18	CHORD TYPE	28	PAD F	38	PAD15		
09	ACC3	19	CHORD VAR	29	PAD00	39	PAD16		
0A	START	1A	KIT	2A	PAD01	3A	PAD17		
0B	STOP	1B	TRACK SEL	2B	PAD02	3B	PAD18		
0C	RESET	1C	SHIFT	2C	PAD03	3C	PAD19		
0D	FWD	1D	FRET >	2D	PAD04	3D	PAD20		
0E	BWD	1E	FRET <	2E	PAD05	3E	PAD21		
0F	ENTER	1F	ACC1	2F	PAD06	3F	PAD22		

Table 4-3 Sequence data

Data included in this area are all user songs and all user patterns.

If you want to send Data Request to the DR-5 in this area, set the address and the size as follows.

address: 20 00 00
size : 01 00 00

The DR-5 ignores the Data Request which designate different address or size. No data in this area can be transferred in unit of one byte.

Table 4-4 Chord data

Data included in this area are all Original Chord data and Chord Assign data. If you want to send Data Request to the DR-5 in this area, set the address and the size as follows.

address: 30 00 00
size : 01 00 00

The DR-5 ignores the Data Request which designate different address or size. No data in this area can be transferred in unit of one byte.

5. Useful Information

Decimal and Hexadecimal

It is common to use 7-bit Hexadecimal numbers in MIDI communication. The following is a conversion table between decimal numbers and 7-bit Hexadecimal numbers.

Dec	Hex	Dec	Hex	Dec	Hex	Dec	Hex
0	00H	32	20H	64	40H	96	60H
1	01H	33	21H	65	41H	97	61H
2	02H	34	22H	66	42H	98	62H
3	03H	35	23H	67	43H	99	63H
4	04H	36	24H	68	44H	100	64H
5	05H	37	25H	69	45H	101	65H
6	06H	38	26H	70	46H	102	66H
7	07H	39	27H	71	47H	103	67H
8	08H	40	28H	72	48H	104	68H
9	09H	41	29H	73	49H	105	69H
10	0AH	42	2AH	74	4AH	106	6AH
11	0BH	43	2BH	75	4BH	107	6BH
12	0CH	44	2CH	76	4CH	108	6CH
13	0DH	45	2DH	77	4DH	109	6DH
14	0EH	46	2EH	78	4EH	110	6EH
15	0FH	47	2FH	79	4FH	111	6FH
16	10H	48	30H	80	50H	112	70H
17	11H	49	31H	81	51H	113	71H
18	12H	50	32H	82	52H	114	72H
19	13H	51	33H	83	53H	115	73H
20	14H	52	34H	84	54H	116	74H
21	15H	53	35H	85	55H	117	75H
22	16H	54	36H	86	56H	118	76H
23	17H	55	37H	87	57H	119	77H
24	18H	56	38H	88	58H	120	78H
25	19H	57	39H	89	59H	121	79H
26	1AH	58	3AH	90	5AH	122	7AH
27	1BH	59	3BH	91	5BH	123	7BH
28	1CH	60	3CH	92	5CH	124	7CH
29	1DH	61	3DH	93	5DH	125	7DH
30	1EH	62	3EH	94	5EH	126	7EH
31	1FH	63	3FH	95	5FH	127	7FH

Dec:Decimal, Hex:Hexadecimal

* To indicate a decimal number for the MIDI channel and Program number, add 1 to the Decimal number in the table.

* The resolution of 7-bit Hexadecimal numbers is 128. Use several bytes for values which require more resolution.

i.e. The number "aa bbH" in 7-bit Hexadecimal is "aa x 128 + bb" in Decimal form.

* A signed number is indicated as 00H = -64, 40H = A10, 7FH = +63. So the signed number "aaH" in 7-bit Hexadecimal is "aa - 64".

A signed number using two bytes is indicated as 00 00H = -8192, 40 00H = A10, 7F 7FH = +8191

So the signed number "aa bbH" in 7-bit Hexadecimal is "aa bbH - 40 00H = aa x 128 + bb - 64 x 128".

* The data indicated as "nibbled" is a 4-bit Hexadecimal number.

i.e. "0a 0bH" is "a x 16 + b".

<EXAMPLE 1> Convert "5AH" in Hexadecimal to a Decimal number.
 (By using the table) 5AH = 90

<EXAMPLE 2> Convert "12 34H" in 7-bit Hexadecimal to a Decimal number.
 (By using the table) 12H = 18, 34H = 52
 So, $18 \times 128 + 52 = 2356$

<EXAMPLE 3> Convert "0A 03 09 0D" in nibblized form to a Decimal number.
 (By using the table) 0AH = 10, 03H = 3, 09H = 9, 0DH = 13
 So, $((10 \times 16 + 3) \times 16 + 9) \times 16 + 13 = 41885$

Example of actual MIDI messages

<EXAMPLE> C9 49
 "CnH" is a status of Program change, and "n" is a MIDI channel number.
 The second byte is a Program number.
 9H = 9, 49H = 73
 So, this is a Program change message of MIDI channel = 10,
 Program number = 74.

Example and Checksum of Roland System Exclusive messages.

Roland System Exclusive messages (RQ1 and DT1) have a Checksum at the end of data (before EOX) to check for communication errors.
 The Checksum results from address and data (or size) included in the message.

How to calculate Checksums ("H" indicates Hexadecimal)

The error checking process uses a Checksum and provides a bit pattern where the last significant 7 bits are zero when values for an address, data (or size) and the Checksum are summed.

If the address is "aa bb ccH" and the data (or the size) is "dd ee ffH"

$$\begin{aligned} aa + bb + cc + dd + ee + ff &= \text{sum} \\ \text{sum} / 128 &= \text{quotient} \dots \text{remainder} \\ 128 - \text{remainder} &= \text{checksum} \end{aligned}$$

<EXAMPLE 1> Set "Pan" of the Pad1 of the User kit1 to "L7"

See the "Parameter address map"
 Address: 01 05 01H (01 00 00H + 00 05 00H + 00 00 01H)
 the value of "Pan": "L7" is 00H

```
F0 41 09 65 12 01 05 01 00   ??   F7
-- -- -- -- -- -- -- -- -- -- --
(1) (2) (3) (4) (5) address data checksum (6)
```

- | | |
|----------------------|----------------------|
| (1) Exclusive Status | (4) Model ID (DR-5) |
| (2) ID (Roland) | (5) Command ID (DT1) |
| (3) Device ID (10) | (6) End of Exclusive |

The Checksum is:

$$\begin{aligned} 01H + 05H + 01H + 00H &= 1 + 5 + 1 + 0 = 7(\text{sum}) \\ 7(\text{sum}) \AA 128 &= 0(\text{quotient}) \Ac 7(\text{remainder}) \\ \text{checksum} &= 128 - 7(\text{remainder}) = 121 = 79H \end{aligned}$$

Therefore, the message to send is: F0 41 09 65 12 01 05 01 00 79 F7

<EXAMPLE 2> Request to transfer the Instrument number of Track3 of User Kit2

See the "Parameter address map"
 address: 02 00 40H
 Size : 00 00 02H

```
F0 41 09 65 11 02 00 40 00 00 02   ??   F7
-- -- -- -- -- -- -- -- -- -- --
(1) (2) (3) (4) (5) address size checksum (6)
```

- | | |
|----------------------|----------------------|
| (1) Exclusive Status | (4) Model ID (DR-5) |
| (2) ID (Roland) | (5) Command ID (RQ1) |
| (3) Device ID (10) | (6) End of Exclusive |

The Checksum is:

$$\begin{aligned} 02H + 00H + 40H + 00H + 00H + 02H &= 2 + 0 + 64 + 0 + 0 + 2 = 68(\text{sum}) \\ 68(\text{sum}) / 128 &= 0(\text{quotient}) \dots 68(\text{remainder}) \\ \text{checksum} &= 128 - 68(\text{remainder}) = 60 = 3CH \end{aligned}$$

Therefore, the message to send is: F0 41 09 65 11 02 00 40 00 00 02 3C F7

Function...	Transmitted	Recognized	Remarks
Basic Channel Default Changed	1 — 16 1 — 16	1 — 16 1 — 16	Stored (Non-volatile)
Mode Default Messages Altered	Mode 3 x *****	Mode 3 x	
Note Number : True Voice	0 0 — 127 *****	0 — 127 *4 0 — 127	*1
Velocity Note ON Note OFF	0 9n v=1 — 127 x	0 x	
After Touch Key's Ch's	x x	x x	
Pitch Bend	x *5	0 *6	
Control Change	1 x	0 *6	Modulation Data Entry Volume Panpot Expression 1 Hold 1
	6,38 x	0	
	7 x	0 *2	
	10 x	0	
	11 0 *2 *3	0 *2	
64 x	0 *6		
100,101 x	0	RPN LSB, MSB All Sound Off Reset All Controllers	
120 x	0		
121 x	0		
Prog Change : True #	0 0 — 119	0 *2 0 — 119	Kit change Program # 1 — 120
System Exclusive	0	0	
System Common : Song Pos : Song Sel : Tune	0 Sync=INT 0 Sync=INT x	0 Sync=MIDI 0 Sync=MIDI x	0 — 19
System Real Time : Clock : Commands	0 Sync=INT 0 Sync=INT	0 Sync=MIDI 0 Sync=MIDI	
Aux Message : Local ON/OFF : All Notes OFF : Active Sense : Reset	x x 0 x	x 0 0 x	
Notes	*1 Note# assignment of drum instruments is used both for transmission and reception. *2 Can be set 0 or x manually and memorized. *3 Transmitted by TRACK LEVEL status in song play mode. *4 Only note# 33 — 96 can be recognized at track 1 — 3 in realtime pattern write (including stand-by). *5 Transmitted corresponding to the signal input from GUITAR IN when "ExtPit" is set at "ON." *6 Cannot be recognized in realtime pattern write (including stand-by).		

Mode 1 : OMNI ON, POLY
Mode 3 : OMNI OFF, POLY

Mode 2 : OMNI ON, MONO
Mode 4 : OMNI OFF, MONO

0 : Yes
X : No

Specifications

DR-5 : Doctor Rhythm Section

Maximum Polyphony

19 voices

Instruments

256

Rhythm Patterns

Preset Patterns: 200

Programmable Patterns: 200

Song

Songs: 20

Total parts for songs: 2000

Resolution

48 clocks per quarter note

Tempo

40 — 250 beat per minute

Display

Custom LCD

Data Input Method

Realtime Write

Step Write

Step Edit

External Pitch

Pads (Fret keys)

36 (Open string keys are included)

Synchronization

MIDI

Connectors

Stereo Output Jacks (L, R)

Headphone Jack

Foot Switch Jack (stereo type)

MIDI Connectors (In, Out)

Guitar In Jack

AC Adaptor Jack (DC9V)

Power supply

DC9V: Dry Batteries (R6 (AA) type) X 6,

AC Adaptor: PSA-120, 220, 240A

Current Draw

130 mA

* Expected battery life under continued use :

Carbon: approx. 3 Hours

Alkaline: approx. 6 Hours

These figures will vary depending on the actual condition of use.

Dimensions

226 (W) X 180 (D) X 45 (H) mm

8-15/16 (W) X 7-1/8 (D) X 1-13/16 (H) inches

Weight

930 g (including batteries)

2 lbs 1 oz

Accessories

Dry Batteries (R6 (AA) type) X 6

Owner's Manual

Options

AC Adaptor: PSA-120, 220, 240A

** The specifications for this product are subject to change without prior notice.*

Index

- [A]**
accent1-10
align6-6
- [B]**
bulk damp9-13
- [C]**
chord function3-9, 3-22
chord type7-2
chord type assign7-2
chord variation assign7-3
- [D]**
decay6-5
demo song1-5
- [E]**
edit chord7-4
error message11-3
exclusive message9-13
external pitch8-2
expression switch9-10
- [F]**
Fill-in to variation pattern5-7
Fill-in to original pattern5-7
Footswitch10-2
- [G]**
gate time3-2
GUITAR IN8-2
- [I]**
instrument1-8, 6-2
instrument assign6-2
initial tempo4-2
initialize11-2
- [K]**
key pad1-8, 2-7
kit1-8, 2-6
- [M]**
master tune8-5
metronome3-18
MIDI channel9-2, 9-9, 9-12
mute1-7
- [N]**
note number9-4
note number assign9-1, 9-8
- [O]**
octave shift6-8
original pattern5-7
- [P]**
pan6-1
part delete4-9
part insert4-10
pattern copy3-11
pattern delete3-12
pattern transpose3-14
program change9-4, 9-5
- [Q]**
quantize3-4
- [R]**
Realtime write3-2, 3-6, 3-21, 4-2, 4-4
repeat4-1
root7-3
- [S]**
section repeat5-4
song chain4-2, 5-3
song clear4-7
song copy4-8
specified pattern change5-7
swing3-18
swing delay3-18
swing point3-18
staccato1-13
step edit3-10
step write3-2, 3-7, 3-19, 4-2, 4-5
system exclusive device ID number9-10
sync mode9-6, 9-11
soft thru switch9-10
standard pitch8-2, 8-5
- [T]**
tenuto1-13
timing shift3-17
time sign3-4
track1-7, 1-9
track level4-1
transpose4-1
tuner8-2, 8-5
- [V]**
variation pattern5-7
velocity9-4
volume6-5
volume switch9-10

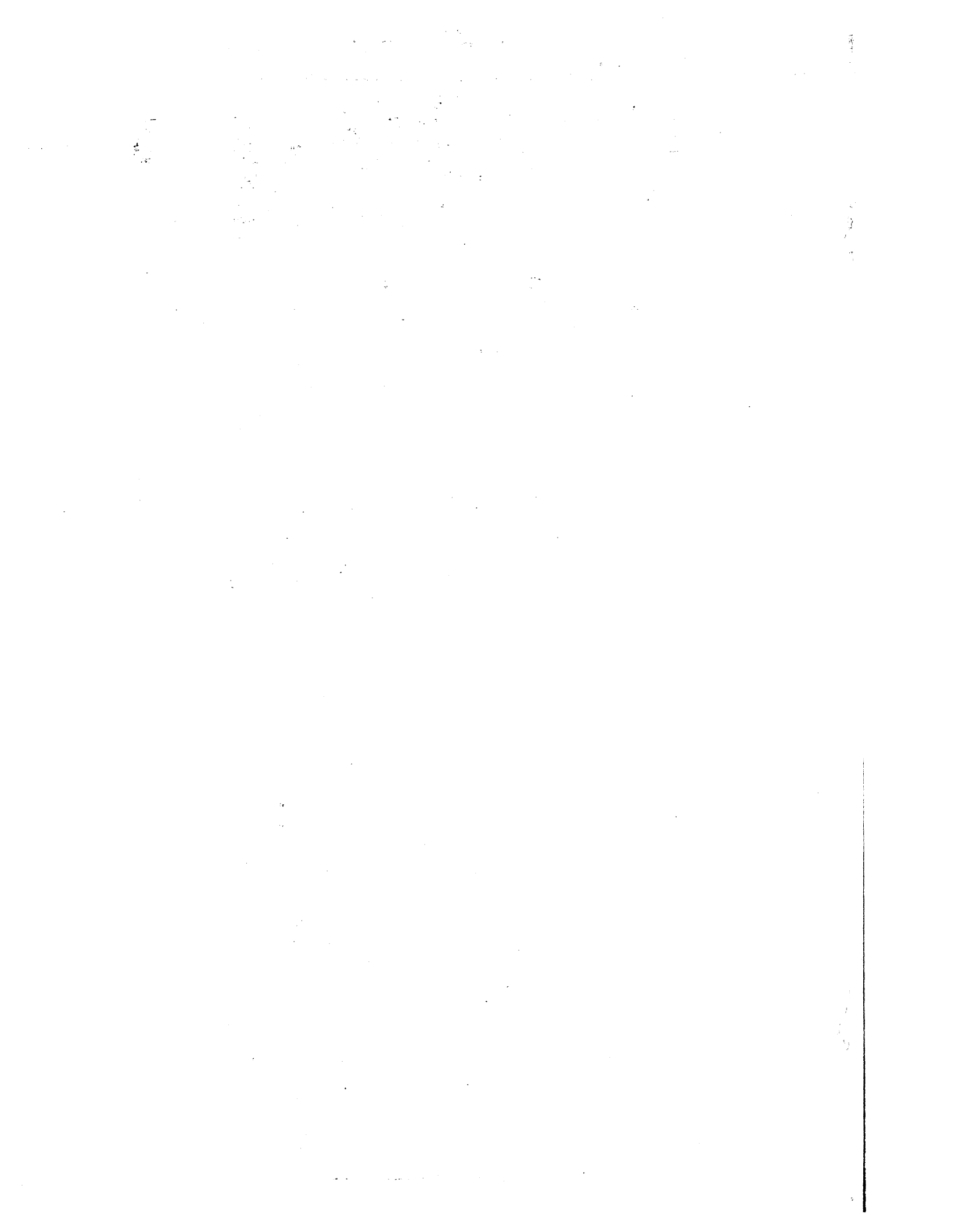

Information

When you need repair service, call your nearest Roland Service Center or authorized Roland distributor in your country as shown below.

ARGENTINA

Instrumentos Musicales S.A.
Florida 656 2nd Floor
Office Number 206A
Buenos Aires
ARGENTINA, CP1005
TEL: (54-1) 394-6057

BRAZIL

Roland Brasil Ltda.
R. Coronel Octaviano da Silveira
203 05522-010
Sao Paulo BRAZIL
TEL: (011) 843 9377

CANADA

Roland Canada Music Ltd.
(Head Office)
5480 Parkwood Way Richmond
B. C., V6V 2M4 CANADA
TEL: (0604) 270 6626

Roland Canada Music Ltd.
(Toronto Office)
Unit 2, 109 Woodbine Downs
Blvd, Etobicoke, ON
M9W 6Y1 CANADA
TEL: (0416) 213 9707

MEXICO

Casa Veerkamp, s.a. de c.v.
Av. Toluca No. 323 Col. Olivar de
los Padres 01780 Mexico D.F.
MEXICO
TEL: (525) 668 04 80

La Casa Wagner de
Guadalajara s.a. de c.v.
Av. Corona No. 202 S.J.
Guadalajara, Jalisco Mexico
C.P. 44100 MEXICO
TEL: (031) 613 1414

PANAMA

Productos Superiores, S.A.
Apartado 655 - Panama 1
REP. DE PANAMA
TEL: (507) 270-2200

U. S. A.

Roland Corporation U.S.
5100 S. Eastern
Los Angeles, CA. 90040-2938,
U. S. A.
TEL: (323) 890 3700

VENEZUELA

Musicland Digital C.A.
Av. Francisco de Miranda,
Centro Parque de Cristal, Nivel
C2 Local 20 Caracas
VENEZUELA
TEL: (02) 285 9218

AUSTRALIA

Roland Corporation
Australia Pty. Ltd.
38 Campbell Avenue
Dee Why West. NSW 2099
AUSTRALIA
TEL: (02) 9982 8266

NEW ZEALAND

Roland Corporation (NZ) Ltd.
97 Mt. Eden Road, Mt. Eden,
Auckland 3, NEW ZEALAND
TEL: (09) 3098 715

CHINA

Beijing Xinghai Musical
Instruments Co., Ltd.
6 Huangmunchang Chao Yang
District, Beijing, CHINA
TEL: (010) 6774 7491

HONG KONG

Tom Lee Music Co., Ltd.
Service Division
22-32 Pun Shan Street, Tsuen
Wan, New Territories,
HONG KONG
TEL: 2415 0911

INDIA

Rivera Digitec (India) Pvt. Ltd.
409, Nirman Kendra,
off Dr. Edwin Moses Road,
Mumbai 400011, INDIA
TEL: (022) 498 3079

INDONESIA

PT Galestra Inti
Kompleks Perkantoran
Duta Merlin Blok E No.6 7
Jl. Gajah Mada No.3 5,
Jakarta 10130,
INDONESIA
TEL: (021) 6335416

KOREA

Cosmos Corporation
Service Station
261 2nd Floor Nak-Won Arcade
Jong-Ro ku, Seoul, KOREA
TEL: (02) 742 8844

MALAYSIA

Bentley Music SDN BHD
140 & 142, Jalan Bukit Bintang
55100 Kuala Lumpur, MALAYSIA
TEL: (03) 2443333

PHILIPPINES

G.A. Yupangco & Co. Inc.
339 Gil J. Puyat Avenue
Makati, Metro Manila 1200,
PHILIPPINES
TEL: (02) 899 9801

SINGAPORE

Swee Lee Company
150 Sims Drive,
Singapore 387381
TEL: 784-1669

CRISTOFORI MUSIC PTE LTD

Blok 3014, Bedok Industrial Park E,
#02-2148, SINGAPORE 489980
TEL: 243 9555

TAIWAN

ROLAND TAIWAN
ENTERPRISE CO., LTD.
Room 5, 9th. No. 112 Chung Shan
N.Road Sec.2, Taipei, TAIWAN,
R.O.C.
TEL: (02) 2561 3339

THAILAND

Theera Music Co., Ltd.
330 Veeng Nakorn Kasem, Soi 2,
Bangkok 10100, THAILAND
TEL: (02) 2248821

VIETNAM

Saigon Music Distributor
(Tan Dinh Music)
306 Hai Ba Trung, District 1
Ho chi minh City
VIETNAM
TEL: (8) 829-9372

BAHRAIN

Moon Stores
Bab Al Bahrain Road,
P.O.Box 20077
State of BAHRAIN
TEL: 211 005

ISRAEL

Halilit P. Greenspoon &
Sons Ltd.
8 Retzif Fa'aliya Hashnya St.
Tel-Aviv-Yaho ISRAEL
TEL: (03) 682366

JORDAN

AMMAN Trading Agency
Prince Mohammed St. P. O. Box
825 Amman 11118 JORDAN
TEL: (06) 4641200

KUWAIT

Easa Husain Al-Yousifi
P.O. Box 126 Safat 13002
KUWAIT
TEL: 5719499

LEBANON

A. Chahine & Fils
P.O. Box 16-5857 Gergi Zeidan St.
Chahine Building, Achrafieh
Beirut, LEBANON
TEL: (01) 335799

OMAN

OHI Electronics & Trading
Co. LLC
P. O. Box 889 Muscat
Sultanate of OMAN
TEL: 959085

QATAR

Badie Studio & Stores
P.O.Box 62,
DOHA QATAR
TEL: 423554

SAUDI ARABIA

Abdul Latif S. Al-Ghamdi
Trading Establishment
Middle East Commercial Center
Al-Khobar Dharan Highway
P.O. Box 3631 Al-Khobar
31952 SAUDI ARABIA
TEL: (03) 898 2332

aDawlah Universal

Electronics APL
P.O.Box 2154 ALKHOBAR 31952,
SAUDI ARABIA
TEL: (03) 898 2081

SYRIA

Technical Light & Sound
Center
Khaled Ibn Al Walid St.
P.O.Box 13520
Damascus - SYRIA
TEL: (011) 2235 384

TURKEY

Barkat Muzik aletleri ithalat
ve ihracat limited ireketi
Siraselvier Cad. Guney Ishani No.
86/6 Taksim, Istanbul TURKEY
TEL: (0212) 2499524

U.A.E

Zak Electronics & Musical
Instruments Co.
Zabeel Road, Al Sherooq Bldg.,
No. 14, Grand Floor DUBAI
U.A.E.
P.O. Box 8050DUBAI, U.A.E
TEL: (04) 360715

EGYPT

Al Fanny Trading Office
P.O.Box2904,
El Horrieh Heliopolis, Cairo,
EGYPT
TEL: (02) 4171828
(02) 4185531

KENYA

Musik Land Limited
P.O Box 12183 Moi Avenue
Nairobi Republic of KENYA
TEL: (2) 338 346

REUNION

Maison FO - YAM Marcel
25 Rue Jules MermanZL
Chaudron - BP79 97491
Ste Clotilde REUNION
TEL: 28 29 16

SOUTH AFRICA

That Other Music Shop
(PTY) Ltd.
11 Melle Street (Cnr Melle and
Juta Street)
Braamfontein 2001
Republic of SOUTH AFRICA
TEL: (011) 403 4105

Paul Bothner (PTY) Ltd.

17 Werdmuller Centre Claremont
7700
Republic of SOUTH AFRICA
TEL: (021) 64 4030

AUSTRIA

E. Dematte & Co.
Neu-Rum Siemens-Strasse 4
6063 Innsbruck AUSTRIA
TEL: (0512) 26 44 260

BELGIUM/HOLLAND/ LUXEMBOURG

Roland Benelux N. V.
Houtstraat 3 B-2260 Oevel
(Westerlo) BELGIUM
TEL: (014) 575811

BELOUSSIA

TUSHE
UL. Rabkorovskaya 17
220001 MINSK
TEL: (0172) 764-911

CYPRUS

Radex Sound Equipment Ltd.
17 Diagorou St., P.O.Box 2046,
Nicosia CYPRUS
TEL: (02) 453 426

DENMARK

Roland Scandinavia A/S
Langebrogade 6 Post Box 1937
DK-1023 Copenhagen K.
DENMARK
TEL: 32 95 3111

FRANCE

Roland France SA
4, Rue Paul Henri SPAAK
Parc de l'Esplanade F 77 462 St.
Thibault Lagny Cedex FRANCE
TEL: 01 600 73 500

FINLAND

Roland Scandinavia As,
Filioli Finland
Lautasaarentie 54 B
Fin-00201 Helsinki, FINLAND
TEL: (9) 682 4020

GERMANY

Roland Elektronische
Musikinstrumente
Handelsgesellschaft mbH.
Oststrasse 96, 22844 Norderstedt,
GERMANY
TEL: (040) 52 60090

GREECE

V. Dimitriadis & Co. Ltd.
20, Alexandras St. & Bouboulinas
54 St. 106 82 Athens, GREECE
TEL: (01) 8232415

HUNGARY

Intermusica Ltd.
Warehouse Area DEPO Pf.83
H-2046 Torokbalint, HUNGARY
TEL: (23) 511011

IRELAND

The Dublin Service Centre
Audio Maintenance Limited
11 Brunswick Place Dublin 2
Republic of IRELAND
TEL: (01) 677322

ITALY

Roland Italy S. p. A.
Viale delle Industrie, 8
20020 Arese Milano, ITALY
TEL: (02) 937-78300

NORWAY

Roland Scandinavia Avd.
Kontor Norge
Lilleakerveien 2 Postboks 95
Lilleaker N-0216 Oslo
NORWAY
TEL: 273 0074

POLAND

P. P. H. Brzostowicz Marian
UL. Blokowa 32, 03624 Warszawa
POLAND
TEL: (022) 679 44 19

PORTUGAL

Tecnologias Musica e Audio,
Roland Portugal, S.A.
RUA SANTA CATARINA
131 - 4000 Porto -PORTUGAL
TEL: (02) 208 44 56

RUSSIA

Slami Music Company
Sadjojawa-Triumfainaja st., 16
103006 Moscow, RUSSIA
TEL: 095 209 2193

SPAIN

Roland Electronics
de España, S. A.
Calle Bolivia 239 08020 Barcelona,
SPAIN
TEL: (93) 308 1000

SWEDEN

Roland Scandinavia A/S
SWEDISH SALES OFFICE
Danvik Center 28, 2 tr.
S-131 30 Nacka SWEDEN
TEL: (08) 702 0020

SWITZERLAND

Roland (Switzerland) AG
Musitronic AG
Gerberstrasse 5, CH-4410 Liestal,
SWITZERLAND
TEL: (061) 921 1615

UKRAINE

TIC-TAC
Mira Str. 19/108
P.O.Box 180
295400 Munkachevo, UKRAINE
TEL: (03131) 414-40

UNITED KINGDOM

Roland (U.K.) Ltd.
Atlantic Close, Swansea
Enterprise Park SWANSEA
West Glamorgan SA7 9FT,
UNITED KINGDOM
TEL: (01792) 700139

77

 **BOSS**

 Roland®

71453156

UPC

71453156



.099:

 **BOSS**