

## DIGITAL SEQUENCER

# CSQ-600

## OWNER'S MANUAL

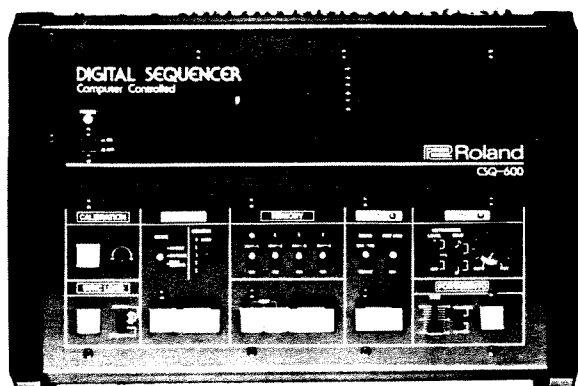

The CSQ-600 is a computer controlled digital sequencer designed for on-stage live performance situations. Connected to a synthesizer the CSQ-600 can be loaded and played back without breaks in rhythm. It can memorize a total of 600 notes with independent time values and can be combined with keyboard generated passages in live performance. The CSQ-600 can be synchronized with a Compu-Rhythm CR-68 or 78 and it can be played simultaneously with another CSQ-600, a CSQ-100 or an analogue sequencer.

The memory of the CSQ-600 is divided into four parts each consisting of 150 notes. The parts may be played in sequence or in a variety of combinations and orders. The sequences can be loaded directly from the synthesizer keyboard (CV for pitch and GATE for rhythm) or the performer can store the CV for pitch and later either add or correct the rhythm with the GATE REWRITE. The SYNC LOAD circuit allows the performer to add information and measures to sequences and to divide passages into 4/4 and 3/4 measures. The METRONOME circuit allows the performer to accurately synchronize the sequence with the quarter note or eighth note pulse of the measure.

Portamento can be either programmed into the sequence or later added manually while the CSQ-600 is running. The battery back-up function allows sequences to be stored in the CSQ-600 even when the machine is turned off. The CSQ-600 is designed to be used with synthesizers having 1V/oct control voltage and positive gate pulse. It is also designed so that the internal connections will not interfere when the keyboard is used to play passages on the synthesizer without the sequencer functioning.

# CONNECTIONS

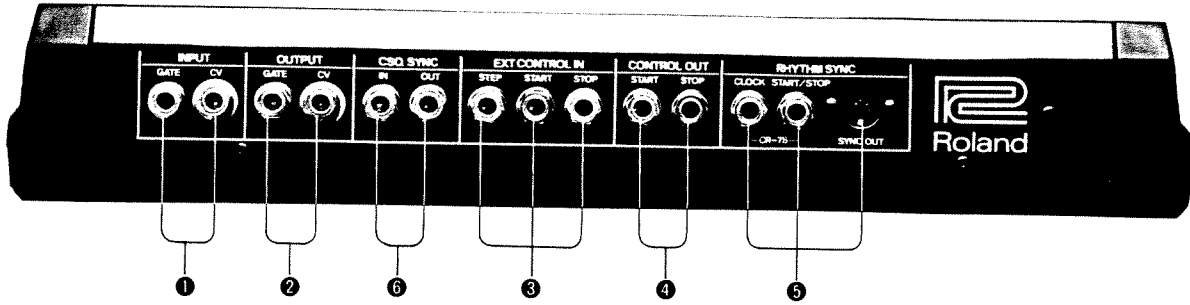

❶ The GATE INPUT and CV INPUT should be connected to the synthesizer keyboard outputs.

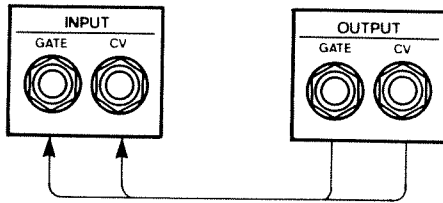

❷ The GATE OUTPUT and the CV OUTPUT should be connected to the synthesizer ENVELOPE GENERATOR (or GATE INPUT) and the VCO Modification Signal Input (or CV INPUT).

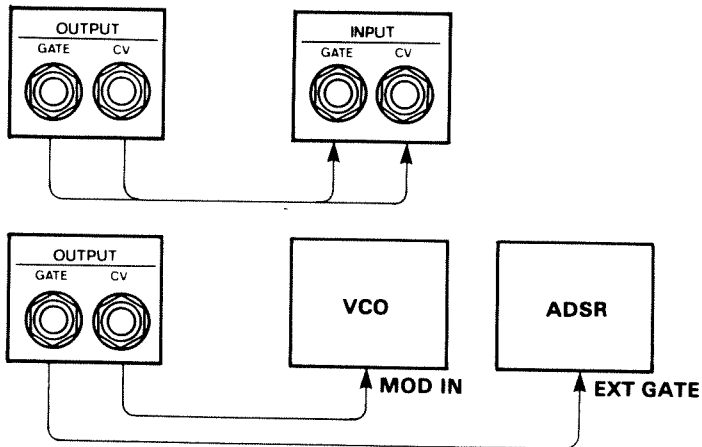

❸ The CSQ-600 is designed to accept external control signals for the purpose of progressing the steps of a sequence and/or triggering the beginning and end of a sequence. The STEP INPUT will control the rhythm of each note in the sequence. The START and STOP INPUTS which can be connected to the Roland DP-2 or DP-1 Pedals allow the performer to start and stop a sequence while simultaneously playing keyboards and manually controlling other circuits.

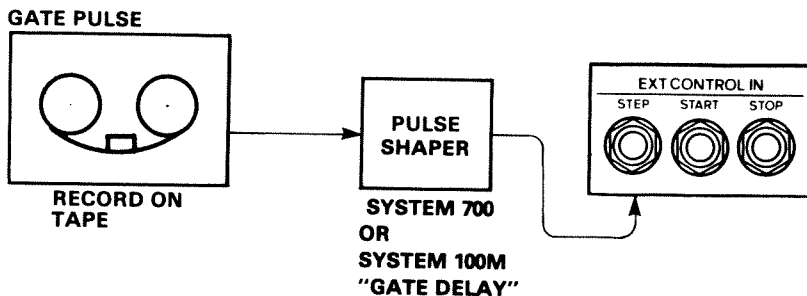
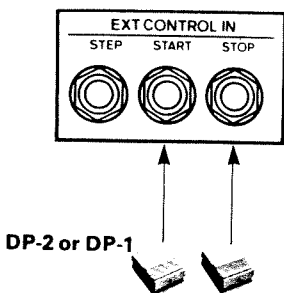
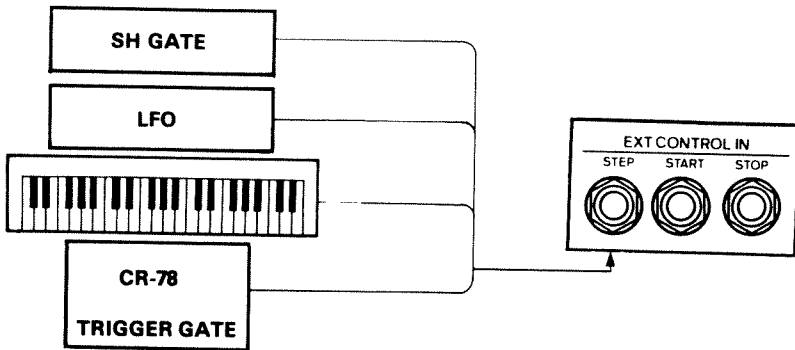

④ The START and STOP CONTROL SIGNALS are output signals that can be connected to other circuits including a second CSQ-600 for the purpose of synchronizing the beginning and end of programmed sequences with additional circuits and information.

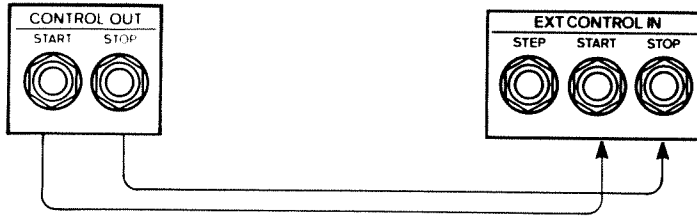

⑤ The RHYTHM SYNC jacks are designed for synchronizing the CSQ-600 with the CR-78 Compu-Rhythm. These are output jacks not input jacks. They are used to control the tempo, etc. of the Compu-Rhythm.

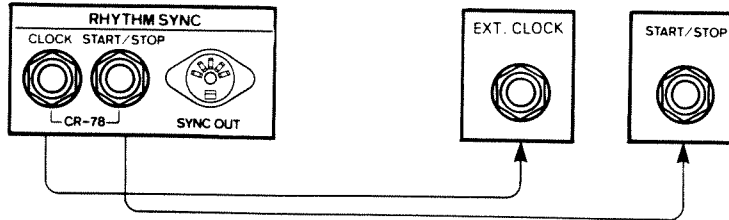

⑥ The CSQ SYNC jacks are used when the performer wishes to interface the CSQ-600 with another CSQ-600. In this instance the OUT jack should be connected to the IN of the second CSQ-600 and the IN jack should be connected to the OUT of the second machine. In addition the CONTROL OUT START and STOP jacks ④ must be connected to the second CSQ-600's EXTERNAL CONTROL IN START and STOP jacks ③ in order to synchronize the pulse (metronome) of the two Sequencers.

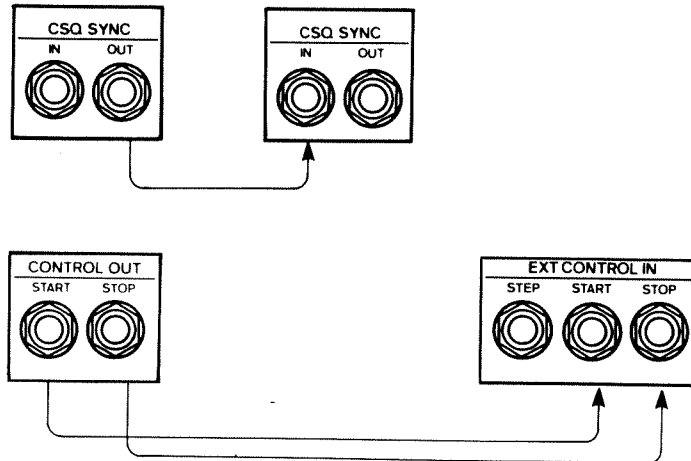

# CONTROLS AND THEIR FUNCTION

## POWER SUPPLY

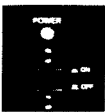

● The power supply for the CSQ-600 is controlled by this switch. Be sure that the switch is OFF before connecting the Sequencer to the line voltage. Also it is important that the Sequencer is OFF when connecting the CSQ-600 to a synthesizer.

● If the line voltage in your area is not stable to within  $\pm 10\%$  of the voltage requirements shown on the nameplate use a voltage regulator.

● Some LED's on the front panel will flash brightly for an instant when the power switch is turned on. This is normal and does not indicate malfunction.

● Avoid using the CSQ-600 in places of high temperature, humidity and dust.

● Neon and fluorescent lights may induce unwanted noise when placed near the CSQ-600 and other electronic music equipment.

## LOAD FUNCTION

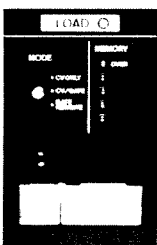

● The CSQ-600 is a digital sequencer that can store a total of 600 notes (control voltages) with rhythm (gate). Unlike an analogue sequencer that must be set manually for each note of a sequence, the CSQ-600 can memorize information directly from a synthesizer keyboard. In addition it is possible to memorize the pitches of a sequence and then rewrite the rhythm with the GATE REWRITE circuit.

### 1. CV (pitch) only LOAD

When the mode switch is set to CV ONLY the control voltages for pitch will be memorized as sixteenth notes. In playback the tempo of the pitches with the same time values can be controlled by the TEMPO control.

### 2. CV/GATE (pitch and rhythm) LOAD

When the mode switch is set to CV/GATE the rhythm as well as the pitch information will be memorized. The sequence can then be reproduced exactly as it was played during the loading process.

### 3. GATE REWRITE

When the mode switch is set to GATE REWRITE the rhythm of the memorized sequence can be reprogrammed. This can be accomplished by tapping the desired rhythm on one key of the synthesizer keyboard after the RESET and LOAD buttons

## CALIBRATION



● It is essential to calibrate the CSQ-600 with the synthesizer keyboard before loading information to the memory circuit. In order to calibrate the CSQ-600 the player should hold down a key near the center of the keyboard. Press **PUSH CAL**. If this causes a vibrato-like effect in the synthesizer output adjust the knob beside **PUSH CAL** to eliminate this effect. Once adjusted it will probably not need attention unless another synthesizer keyboard is used.

**Note:** Be sure that the VCO, VCF or VCA of the synthesizer are not being modulated by an LFO etc. while you are calibrating the CSQ-600.

● The five LED lights indicate the percentage of notes stored in one part.

This is a useful indicator for determining how many pitches can be added to a sequence that is being memorized (each part can store a total of 150 notes with rhythm).

● The most common procedure for loading information in the CSQ-600 is to push the **RESET** and **LOAD** buttons and then to play the sequence on the synthesizer keyboard. In sequences that will be repeated continuously it is suggested that the player press the **PLAY** button at the end of the loading procedure rather than the **STOP/CONTINUE PLAY** button. It is also possible to correct or change notes in a memorized sequence. After listening to the sequence

push the **STOP/CONTINUE PLAY** button just before the first note that is to be changed. Then push the **LOAD** button (not the **RESET** button) and play the new information on the keyboard. Note that all of the information after the first note that is corrected will automatically be erased.

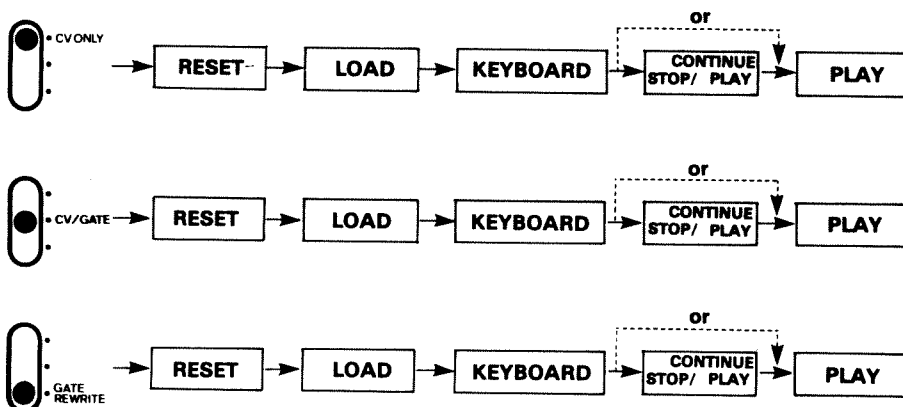

In the normal load procedure the GATE will trigger on and off each time a key is depressed.

However with the Legato Keyboard technique the GATE will trigger ON at the beginning of the phrase and will not change to OFF until the phrase has been completed and the final key has been released.

For Legato Style where it is desired to have no break in sound between pitches, play on two keys using the technique sometimes used for playing trills on synthesizers where one key is held down continuously while the second key is tapped on and off.

#### ● Non Legato

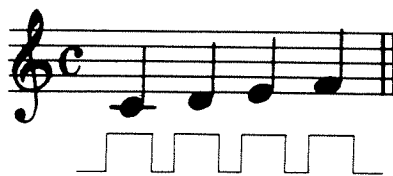

#### ● Legato



- By pressing the **FWD STEP** and the **BACK STEP** buttons at the **same time** you can load rests in to the sequence.

When using the CV ONLY mode one rest will be added to the sequence each time you press both the **FWD STEP** and **BACK STEP** buttons. When using the CV/GATE mode a series of rests will be memorized until you play the first note on the keyboard.

- CSQ-600 can be synchronized with the CR-78 or CR-68. By loading rests in the sequence you can effectively create a pattern (such as a bass pattern) that can be combined with the rhythm patterns of the rhythm machines.

### MEMORY

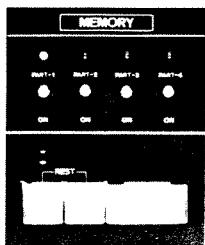

- The memory of the CSQ-600 is divided into four parts each consisting of 150 notes. The parts may be played in sequence (1-4) or may be played in one of the following sequences by activating the necessary switches (1234, 123, 124, 12, 13, 14, 134, 234, 23, 24, 34, 1, 2, 3, 4). In addition the order of the four parts can be controlled manually during performance by activating

the desired part switch. However it should be noted that the memory of one channel must be completed before the newly activated part can be played. If the part switch is changed before the first sequence has been completed a silence the length of the remaining memory of the first part will be created before the second part can be played.

- The **BACK STEP** button progresses the sequence one step backward each time that it is depressed. The **FWD STEP** button progresses the sequence one step forward each time it is depressed. By pressing the **STOP/CONTINUE PLAY** button the sequence will be stopped. By pressing the **STOP/CONTINUE PLAY** button a second time the sequence will continue where it left off.

- The CSQ-600 is equipped with a back-up system for the memory circuit. This battery allows the information to be stored up to a maximum of six months without the power supply on.

### TEMPO-METRONOME

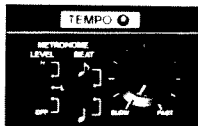

- The METRONOME is activated whenever the **LOAD** button is depressed. The LED above the TEMPO control flashes at either quarter note or eighth note intervals. If the METRONOME LEVEL switch is set to H or L an audible metronome beat will occur.
- The TEMPO control is adjustable and can be used to set or change the speed of the sequence and any machine or circuit connected to the CSQ-600.

- The audible signal can be set to produce either quarter note references or eighth note references.

● When you are not using the Metronome when loading information set the controller to the approximate TEMPO of the music.

● If you load slow music while the controller is set to a fast TEMPO, the memory capacity will be used up quickly.

● If, on the other hand you load fast music while the controller is set to a slow TEMPO, the rhythm may become distorted during playback.

● When CV only is used all the notes will have the same duration. The TEMPO and

Rhythm will only be added during playback by varying the TEMPO controller, etc.

## SYNC LOAD

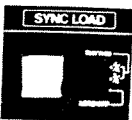

● By using the SYNC LOAD it is possible to memorize information divided into measures of 4/4 and 3/4 time. The SYNC LOAD circuit can also be used for repeating measures and is essential for synchronizing complex rhythms (such as a bass line) with 4/4 measure patterns of the Compu-Rhythm CR-78 and for synchronizing the CSQ-600 with another CSQ-600.

● Procedure for using the SYNC LOAD:  
1. Set the RHYTHM switch to the 4/4 or

3/4 setting (note that the switch must be in the OFF position when you are not using the SYNC LOAD circuit).

2. Set the metronome beat switch to quarter note position. Then press the **LOAD** button and control the metronome speed by the TEMPO control.

3. Press the **RESET** and then the **LOAD/STOP** buttons.

4. Start playing the sequence on the keyboard at the beginning of the third measure of the metronome count. (The SYNC LOAD circuit uses the first two measures (8 beats for 4/4 and 6 beats for 3/4) to set the tempo and beat of the sequence to be memorized. Note that during this time even if you press a key **no sound** will be

memorized. It should also be noted that starting with the third measure (actually the first measure of the sequence) all information will be memorized. Therefore if you do not play a note at the beginning of the third measure a silence will be memorized into the circuit until you play the first note.

5. If you press the **LOAD/STOP** button again it will stop after the next even measure has been added. (Note that when the SYNC LOAD circuit is used the information is memorized in two measure groups. Therefore if you stop the Loading sequence in the middle of the 7th measure the SYNC LOAD circuit will stop at the end of the 8th measure.)

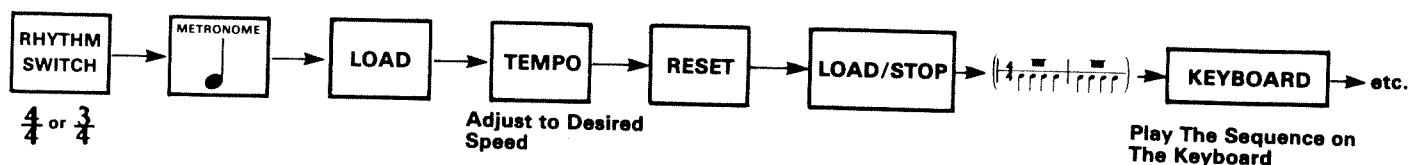

## PLAY FUNCTION



● Pressing the **PLAY** button causes the sequence to start from the beginning. The sequence may be stopped at any point by pressing the **STOP/CONTINUE PLAY** button. Pressing the **STOP/CONTINUE PLAY** again will start the sequence from where it left off.

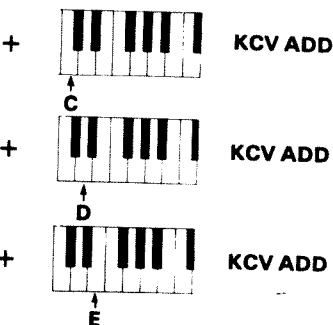
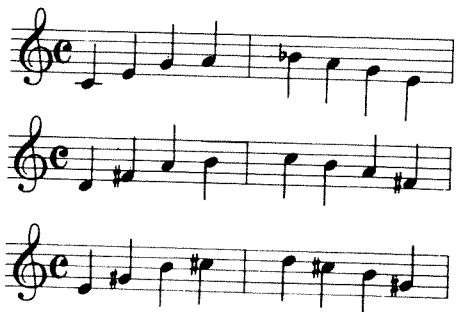

● By setting the mode switch to ONE TIME the sequence will be played one time only. By setting the mode switch to REPEAT the sequence will be repeated continuously until you push the **STOP/CONTINUE PLAY** button.

● The KCV ADD (keyboard control voltage add) switch allows the synthesizer keyboard to transpose the sequence to whatever key is depressed on the keyboard. The transpose function is based on the standard in which a voltage of +2 volts from the keyboard will produce the pitch of middle C when the VCO is set for the B' range. The ROLAND SH-5 and System

100 (model 101) use different voltages to produce the pitch of middle C. This means that with the SH-5 pressing F will produce the sequence in its original key and on the System 100 pressing E will do the same.

● However when using the KCV ADD function with most ROLAND synthesizers pressing middle C will cause the sequence to be reproduced in the key that was used when it was loaded. Pressing D above middle C will transpose the sequence up a major second. If the original sequence was loaded in the key of C pressing F will transpose it to the key of F, pressing G will transpose it to the key of G, etc.

## PORTAMENTO



● Portamento is the gliding of a note from one pitch to another. The PORTAMENTO control adds this effect to the control voltage (pitch) of the output of the CSQ-600. The effect can be added manually during playback of a sequence or it can be pro-

In order to program the portamento effect set the Portamento switch to program, adjust the slide control to the desired amount of glide between notes and push the **PORTA MEMO** button while loading information. The higher the sliding control is set the smoother the glide from one note to the next.

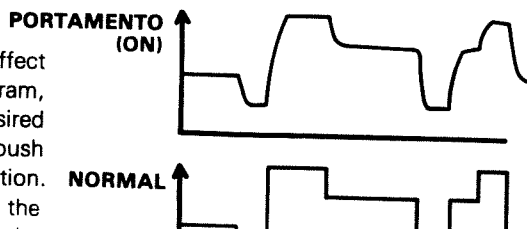

## EXAMPLES OF HOW TO USE THE CSQ-600

**1. ARPEGGIOS:** Load a C major arpeggio in PART-1. Then load a C minor arpeggio in PART-2. Set the PLAY MODE switch at REPEAT and the KCV ADD switch to ON. Press **PLAY**. The keys on the keyboard will now decide the root of the chord being produced and the Part selectors of the memory circuit will control whether the chord is major or minor.

**LOAD**

<b>PART-1</b> major	
<b>PART-2</b> minor	

**PLAY**



<b>PART</b> → 1	2	(2)
Key → C	D	E

**2. BASS PATTERNS:** Set the PART-1 switch to the ON position and load a basic bass pattern. Then set the PART-2 switch to the ON position and load a variation of the pattern. During playback you can choose either PART-1 or PART-2 as the music progresses.

**LOAD**

<b>PART-1</b> basic pattern	
<b>PART-2</b> variation	

**PLAY**



<b>PART</b> → 1	(1)	(1)
Key → C	(C)	F

<b>PART</b> → (1)	(1)	2
Key → C	G	C

**3. REPEATING PHRASE:** Set the sequencer to LOAD and PLAY the phrase that you want to be repeated.

When you finish loading the phrase don't press the **STOP/CONTINUE** button. Instead press the **PLAY** button immediately.

When the PLAY MODE is set to REPEAT the sequence will be repeated as many times as you want. You can experiment with numerous techniques and applications of this circuit. You can produce an "echo" effect by gradually lowering the volume while the sequence is being repeated. You can also experiment with variations in tone color while the sequence is being repeated by varying the VCF controls.

**LOAD**



**PLAY**



procedure ( ● VOLUME—"echo" effect  
● VCF—variation in tone color)

## ADDITIONAL INFORMATION:

### 1. Starting the sequencer with a pedal:

The START jack allows the start of the sequencer play function to be controlled by an external source. The input circuit of the START jack is designed to accept shorting type switches such as the ROLAND DP-1 or DP-2.

### 4. Playing a Duet in the Same Rhythm:

With two synthesizer systems (two VCO, VCF, VCA and ENV) it is possible to play two voices in the same rhythm. Load pitches into the sequencer with the first synthesizer in the normal manner. Next, press **RESET** and play a melody in counterpoint to the second synthesizer. The rhythm of the previously loaded pitches will follow the rhythm being played on the second synthesizer.

### 2. Starting the Sequencer with a SYNTHESIZER GATE:

The input jack will accept a positive going pulse (+3V to +15V) from a synthesizer keyboard, etc. Using the keyboard pulse for starting a sequence can be very useful when you wish to trigger an arpeggio with the KCV ADD function included.

### 3. Progressing the Sequencer by STEP with the synthesizer Keyboard:

By adding the external pulse voltage (+3V to +15V) to the EXT STEP jack it is possible to step the sequence one note at a time. The diagram shows how the CSQ-600 can be stepped by the GATE voltage of the synthesizer (The CV which has been loaded into the CSQ-600 can be used to control the VCF as well as the VCO).

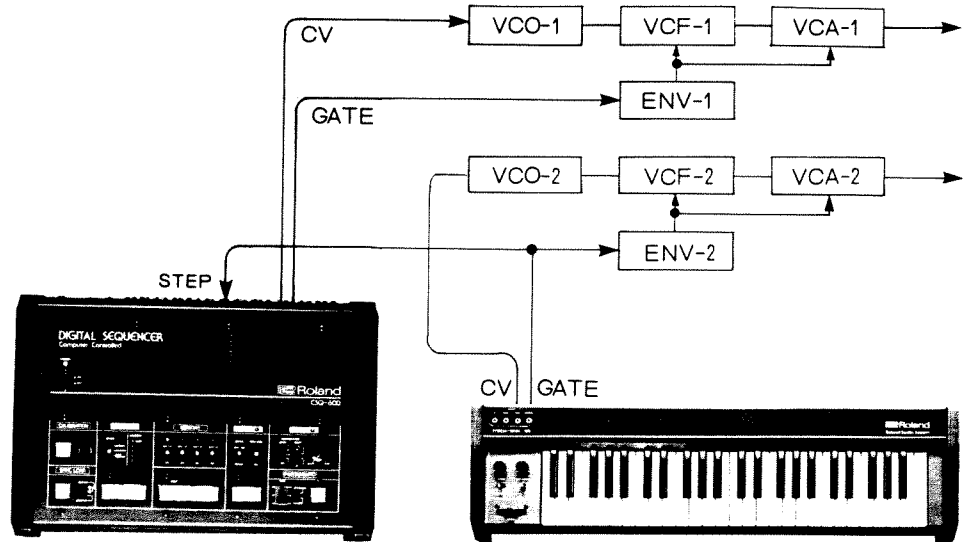

### 5. Playing chords with the CSQ-600 and an analogue sequencer:

By combining the CSQ-600 with an analogue sequencer it is possible to play chords simultaneously. The diagram shows how to connect the CSQ-600 to the M-182 sequencer of the System 100M.

Connect the GATE OUT of the CSQ-600 to the TRIG IN of the M-182 and control the step of the M-182 by the CSQ-600. Set the REPEAT/STEP/SINGLE switch of the M-182 to the STEP position. Load the first voice (VCO1) in the CSQ-600. Set the second and third voices on the 2 channels of the M-182 (VCO2 and VCO3). Step the M-182 to the last step and start the CSQ-600 (The M-182 will step with the GATE of the CSQ-600 simultaneously producing three note chords in the same rhythm).

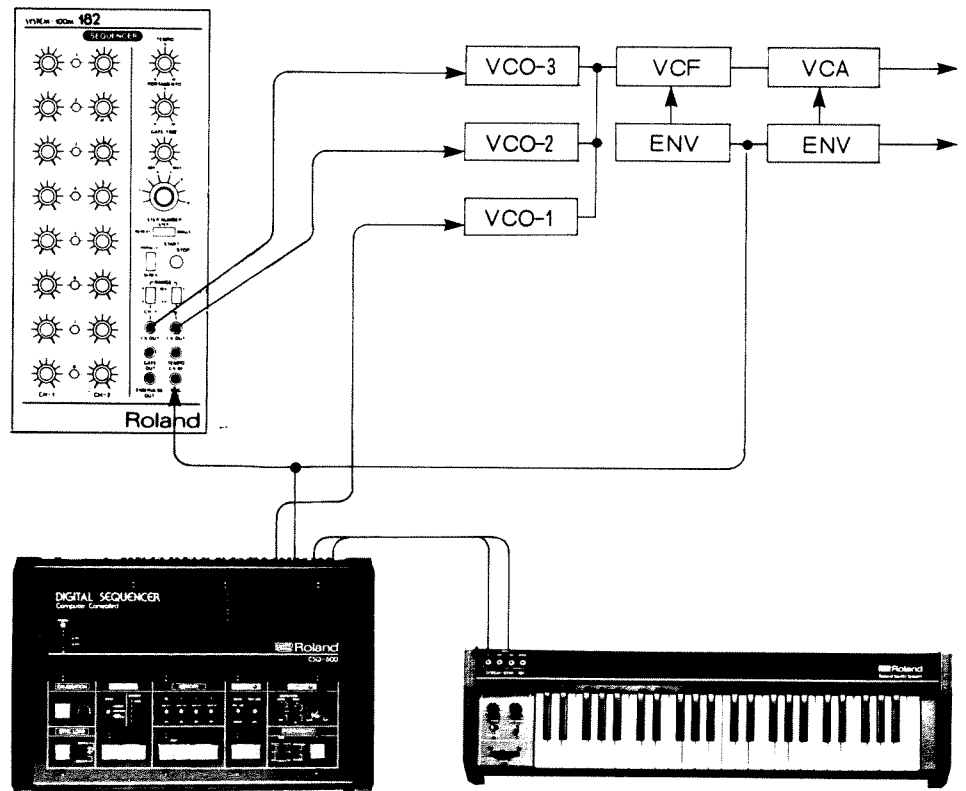



**6. Playing Simultaneously with in Rhythm (Step):**

When the trigger of the Compu-Rhythm CR-68, CR-78 or the Boss Doctor-Rhythm DR-55 is connected to the STEP jack of the CSQ-600 it is possible to Play (STEP) one step at a time. Load pitches and set the PLAY MODE switch at REPEAT. Press the sequencer [RESET] button before pressing the Compu-Rhythm [START] button. When you put the KCV ADD switch ON you can play with the root of any chord you want.

- Example one shows an arpeggio pattern using the 16 beat trigger of the DR-55, or the CR-68, 78.
- Example two shows a bass pattern using the 8 beat trigger of the CR-68, 78.
- Example three shows how the CSQ-600 can be controlled by the output of the DR-55 in the accent position.

**7. Simultaneously Playing with the CR-78 (CLOCK):**

By connecting the CR-78 with the CSQ-600 as in the diagram it is possible to play a completely free rhythm.

- In this case you must load with the SYNC LOAD. Set the MODE switch of the SYNC LOAD to 4/4.
- When you press the SYNC LOAD button the CR-78 will start with the metronome. After that proceed with the SYNC LOAD operation. (If the START/STOP of the CSQ-600 and the CR-78 functions are in the opposite mode press the START/STOP button of the CR-78 once.).

**● Connect to DR-55, CR-68, CR-78**

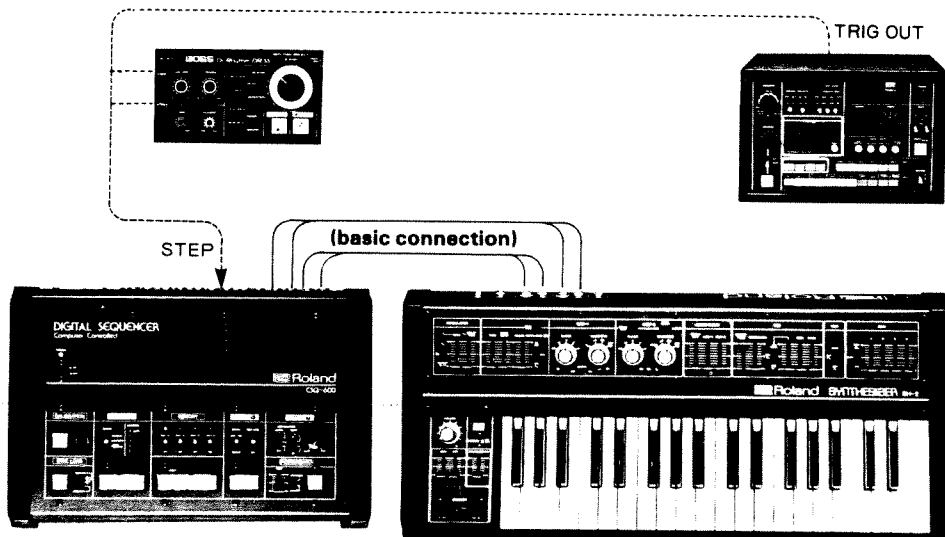

**● Each output power pulse of DR-55, CR-68, CR-78**

DR-55	DBS	
	CSQ	rhythm with accent
CR-68	8"	
	16"	
CR-78	COMBI	the output pulse of the base drums, high bongo

EX-1



EX-2



EX-3



EX-3'



**● Connection with CR-78**

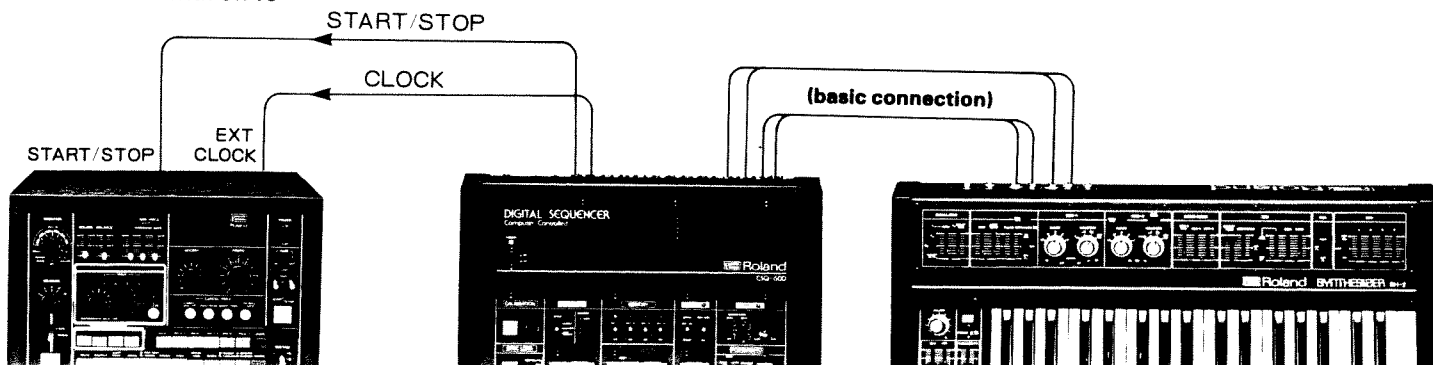

● CSQ-600 × 2

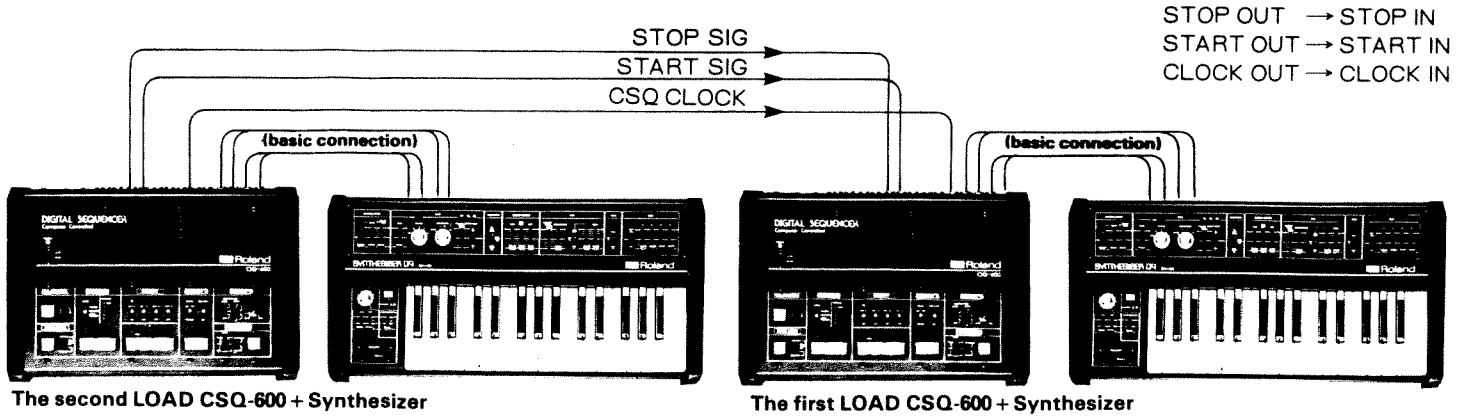

8. Playing Simultaneously with another CSQ-600:

As shown in the diagram you need three extra cords to run the two CSQ-600 Sequencers (one for the CLOCK PULSE to make the tempo of the two CSQ-600 Sequencers equal and two for sending the START and STOP signals.).

● You must load the information in the SYNC LOAD position when you use the multiple CSQ-600 system. The first load is exactly the same as the regular SYNC LOAD procedure. The second load should be made while listening to the information in the first load procedure.

● When the LOAD/STOP button of the second CSQ-600 is pressed it is possible to hear the metronome. Information can be loaded starting with the **third** measure. Because the first CSQ-600 is in the PLAY mode it is possible to hear the information on the first CSQ-600 while programming the second sequencer.

The first CSQ-600

**order**

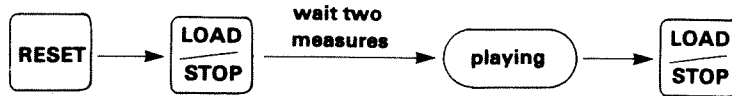

The second CSQ-600

**order**



● The example of 3 CSQ-600 + CR-78.

\*Use Multiple jack Boss J-5 to divide CSQ clock.

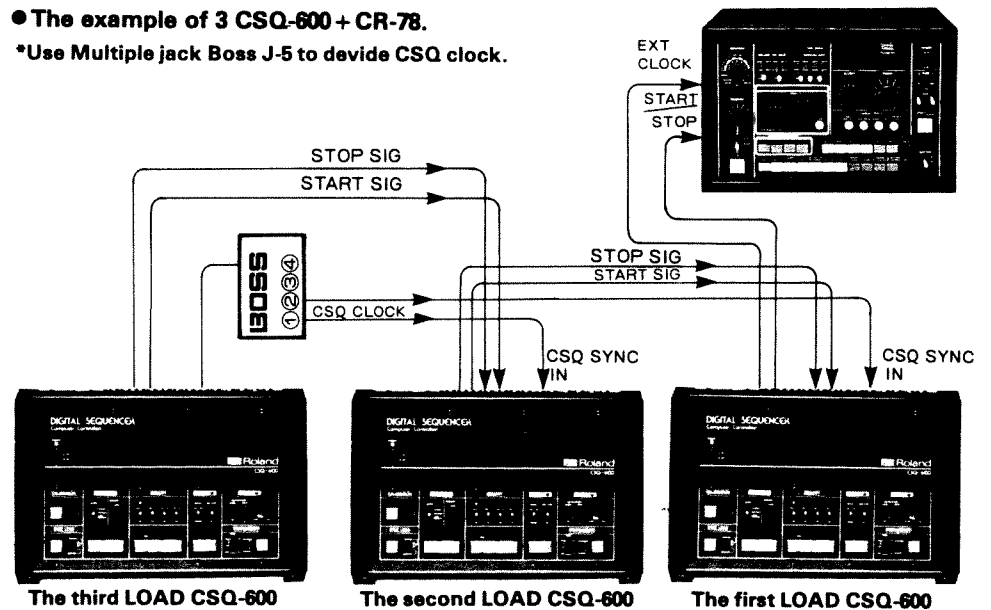

## SPECIFICATIONS

### Maximum storage capacity:

600 notes (150 notes x four parts)

### Calibration:

CALIBRATION button  
CALIBRATION adjustment control

### Metronome:

LED tempo indicator  
Metronome level switch (H, L, OFF)  
Quarter note, eighth note, switch  
Tempo control

### Load Section:

LED load indicator  
LED memory indicator (x5)  
LOAD MODE switch (CV ONLY, CV/  
GATE, GATE REWRITE)  
RESET button  
LOAD button

### Sync Load Section:

Rhythm meter selector (4/4, 3/4, OFF)  
LOAD/STOP button

### Memory Section:

LED memory part indicator (x4)  
PART SELECTOR switches (1-4)  
STOP/CONTINUE PLAY button  
BACK STEP button  
FORWARD STEP button

### Play Section:

LED indicator  
PLAY MODE switch (ONE TIME,  
REPEAT)  
KCV ADD switch

### Portamento Section:

PORTAMENTO button  
TIME level  
PROGRAM/MANUAL switch

### Power Supply:

POWER on-off button

### Jacks:

GATE, CV input (CV = 1 oct./V, 0V ~  
+5V) (Gate = on at +2.5V)  
GATE, CV output (CV = 1 oct./V, -2V ~  
+8V) (Gate = OFF: 0V, ON: +15V)  
CSQ SYNC in, out (clock)  
EXT CONT IN step, start, stop  
STEP (+2.5V), START (open or  
+15V), STOP (open or +15V)  
CONTROL OUT start, stop  
RHYTHM SYNC clock, start/stop, sync  
out (START SIGNAL, GND, CLOCK)

### Power Consumption:

8W

### Dimensions:

450(W) x 305(D) x 95(H) mm

### Weight:

3.9kg

### Accessories supplied:

1.5m dual cord (H-41) x2

**Note:** Specifications are subject to change without notice.

## Optional



PEADAL SWITCH DP-2

**Roland®**

**RUS10076**

UPC

RUS10076

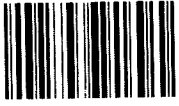

10901

**Roland®**