

# **BOSS** **AW-2** Auto Wah

## Instructions

Thank you for purchasing the BOSS AW-2 Auto Wah effect pedal. To take full advantage of this device, be sure to read these instructions carefully.

- The AW-2 can create a variety of automatic wah-wah (auto wah) effects using the SENS (Sensitivity) control and the Modulation function.
- By using the picking wah and the modulation wah at the same time, different wah effects can be produced at picking and decay.
- By setting the basic frequency with the Manual Control, a unique wah effect of narrow variable band can be produced.

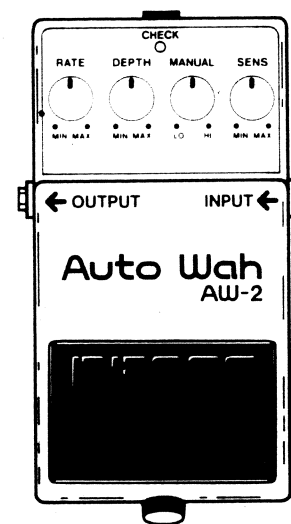

## PANEL DESCRIPTIONS

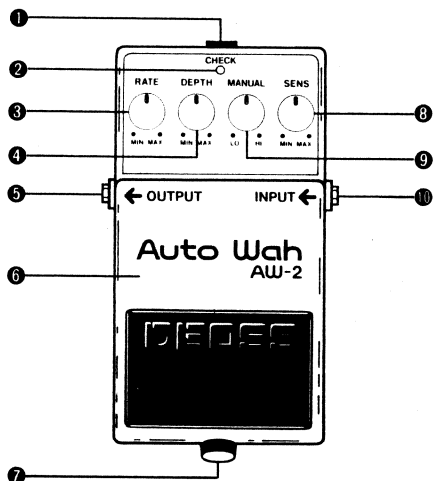

### 1 AC ADAPTOR JACK

Connect an AC adaptor (BOSS PSA-120, 220 or 240) to this jack.

\* An AC adaptor provides a stable, dependable supply of power.

\* Be sure to use a BOSS PSA-120, 220 or 240, depending on the voltage system in your country. Using any other type of AC adaptor may cause malfunctions.

### 2 CHECK INDICATOR

This LED lights when the effect is turned on.

\* The Check indicator also serves as a battery check. When the LED becomes dim, replace the battery.

### 3 Modulation RATE Knob

This knob controls the rate of the modulation effect. Clockwise rotation increases the rate and counterclockwise rotation decreases it.

\* When the Modulation DEPTH knob is at MIN (⌚), the Modulation RATE knob does not function.

### 4 Modulation DEPTH Knob

This knob controls the sweep width (variable range) of the modulation effect. Clockwise rota-

tion makes the range wider. At MIN (⌚), no modulation effect is produced.

\* To control the wah effect with your playing intensity only, set the Modulation DEPTH Knob to MIN (⌚).

### 5 OUTPUT JACK

Connect an amplifier or other effect to this jack.

### 6 PEDAL SWITCH

Pressing the pedal turns the effect on and off.

### 7 THUMB SCREW

Loosen the screw to open the pedal for battery replacement.

For a detailed explanation of battery replacement, refer to "BATTERY REPLACEMENT".

### 8 SENS Control Knob

This knob adjusts the sensitivity of the wah effect. Rotating the knob clockwise allows you to obtain a wah effect even with soft playing. Rotating the knob counterclockwise produces wah effects only with harder playing.

\* The intensity of the wah effect will be affected not only the volume, but also by the type of pickup on your instrument. Adjust the SENS

control knob so that an appropriate sensitivity is obtained for your guitar and playing style.

\* When the SENS control knob is at MIN (⌚), no wah effect will be produced even by increasing picking strength.

### 9 MANUAL Knob

This knob controls the basic frequency (where the wah effect starts to work). Rotating the knob clockwise will increase the frequency, while rotating it counterclockwise will decrease it.

\* The maximum frequency of the wah effect (obtained by using the SENS control knob) is fixed. Setting the MANUAL knob to HI (⌚) will decrease the width of the sweep (variable range).

### 10 INPUT JACK

Connect an electronic/electric musical instrument (such as a guitar) to this jack.

\* Connecting a plug to this jack will automatically switch the unit on. Be sure to disconnect the plug from this jack when the unit is not being used.

## CONNECTIONS

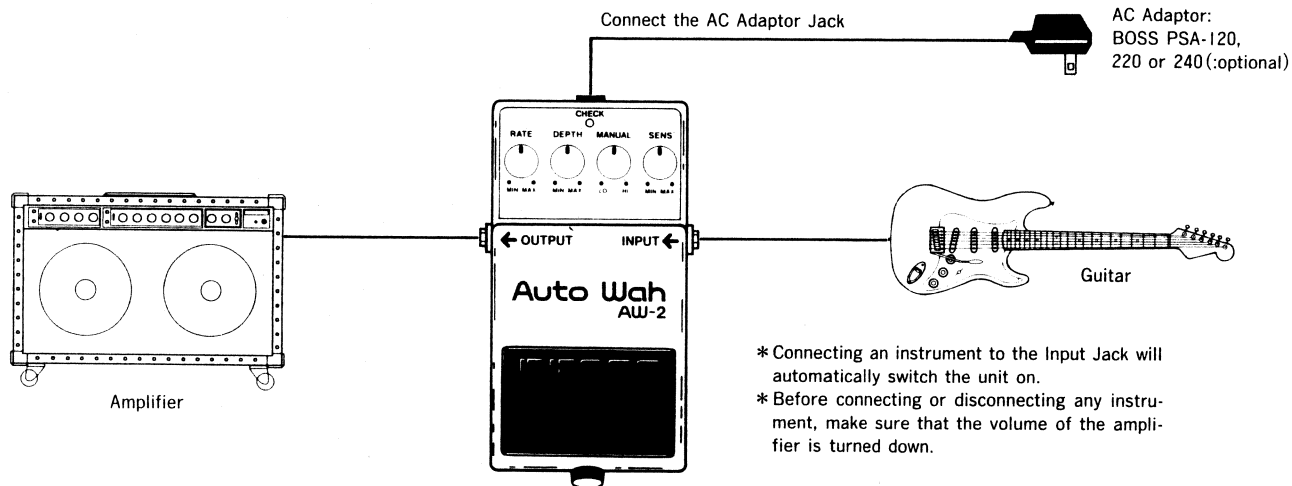

\* Connecting an instrument to the Input Jack will automatically switch the unit on.

\* Before connecting or disconnecting any instrument, make sure that the volume of the amplifier is turned down.

\* Using a high-output instrument with the AW-2 may cause sound distortion. If this happens, turn down the volume on the instrument or use a limiter to decrease the volume.

## OPERATION

### [To control the Wah effect with the Modulation Function]

① Set the control knobs as shown in the diagram to below. Turn on the effect by pressing the pedal. (Make sure that the Check Indicator lights.)

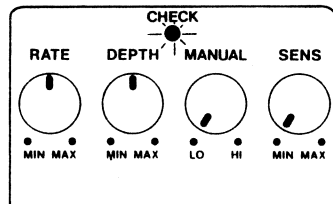

② Adjust the rate of the modulation effect with the RATE Knob. Clockwise rotation will increase the rate, while counterclockwise rotation will decrease it.

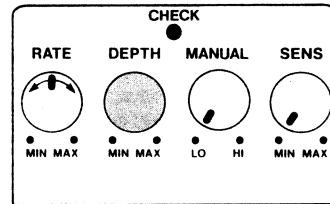

③ Adjust the basic frequency (where the effect starts working) with the MANUAL knob. Clockwise rotation will increase the frequency, while counterclockwise rotation will decrease it.

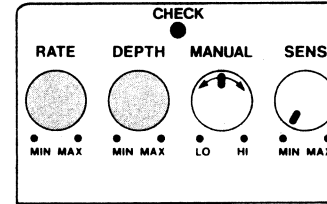

④ Adjust the sweep width of the modulation with the DEPTH knob. The actual modulation varies depending on the basic frequency set with the MANUAL knob. Rotating the DEPTH knob clockwise will increase the width of the sweep. With the knob set at MIN (↺), no modulation effect will be produced.

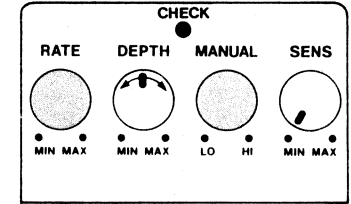

\* If you wish to control the wah effect with your playing strength at the same time, adjust the SENS control knob.

## OPERATION

### [To control the Wah effect with playing strength]

① Set the control knobs as shown in the diagram to below. Turn on the effect by pressing the pedal. (Make sure that the Check Indicator lights.)

\* When the Modulation DEPTH knob is set to MIN (↺), no modulation effect is produced. The Modulation RATE knob will therefore not function either.

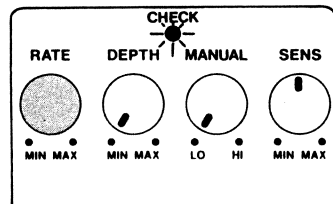

② Adjust the sensitivity of the wah effect using the SENS control knob. Rotating the knob will allow you to obtain a wah effect even with soft playing. Rotating the knob counterclockwise will allow you to obtain the effect only with stronger playing.

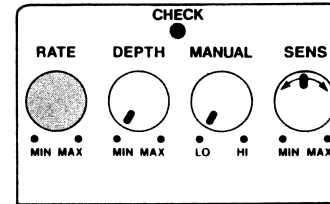

③ Set the basic frequency (where the effect starts to work) with the MANUAL knob. Clockwise rotation will raise the frequency, while counterclockwise rotation will lower it.

\* The maximum frequency of the wah effect (obtained by using the SENS control knob) is fixed. Setting the MANUAL knob to HI (↻) will decrease the width of the sweep (variable range).

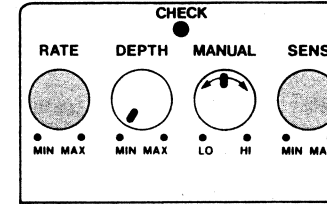

\* If you wish to use the Modulation effect at the same time, adjust both the RATE and DEPTH knobs.

## ■ SAMPLE SETTINGS

### [Picking Wah by Sens Control]

Wah effect can be created by changing picking strength. Adjust the position of the Sens Control Knob depending on the guitar you use and the playing style.

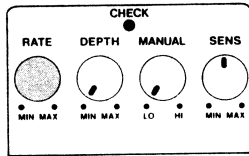

### [Manual + Sens Wah]

Wah effect starts working at the frequency set with the Manual Knob.

\* When the Manual Knob is set to the HI position, the wah effect will be weaker.

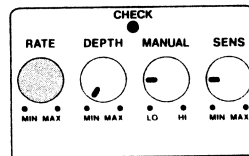

### [Modulation Wah]

This is a wah effect created by using the Modulation function. The same effect obtained with the Pedal Wah will be automatically created.

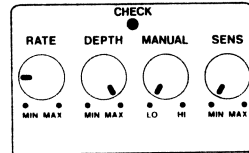

### [Manual + Sens + Modulation Wah]

Wah effect starts working at the frequency set with the Manual Knob. When the input sound is decreasing, modulation effect is added.

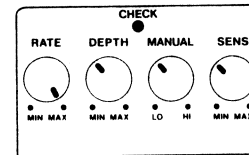

### [Manual + Modulation Wah 1]

Wah effect takes on modulation at the low frequency set with the Manual Knob.

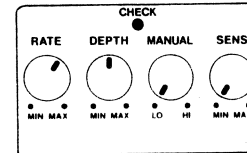

### [Manual + Modulation Wah 2]

Wah effect takes on modulation at the high frequency set with the Manual Knob.

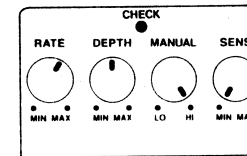

### [Sens + Modulation Wah]

Picking wah is created, then modulation wah is added when the input sound is decreasing.

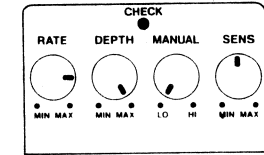

### [Filter Effect]

This creates filter effect similar to that obtained by stopping the Pedal operation (Pedal Wah). You can change the frequency of the filter using the Manual Knob.

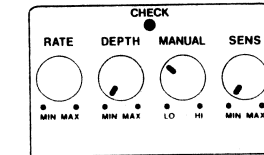

## ■ BATTERY REPLACEMENT

- ① Loosen the thumb screw on the pedal to open it.
- ② Take out the battery from the battery housing and disconnect the battery snap.
- ③ Connect a new battery to the battery snap, then replace the battery in to the battery housing.  
\* Make sure that the polarity of the battery is correct.
- ④ Push the coil spring into the spring base on the rear of the pedal, then close the pedal.  
\* Make sure that the snap cord is not caught in the pedal or coil spring.
- ⑤ Insert the thumb screw into the guide bush hole and firmly tighten the screw.

### Use one 9-volt battery

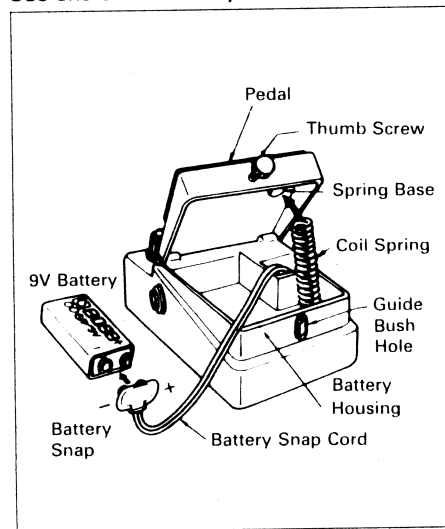

## ■ IMPORTANT NOTES

- Do not subject the unit to temperature extremes (eg. direct sunlight in an enclosed vehicle). Avoid using or storing the unit in dusty or humid areas or areas that are subject to high vibration levels.
- Remove the battery whenever the unit is not going to be used for an extended period of time.
- When operating solely on a battery, the unit's indicator becomes dim when the battery is depleted. Replace the battery immediately.
- If there is a battery in the unit while an AC adaptor is being used, normal operation will continue should the line voltage be interrupted (power blackout) or the power cord become disconnected.
- Should a malfunction occur (or if you suspect there is a problem) discontinue use immediately. Contact

qualified service personnel as soon as possible.

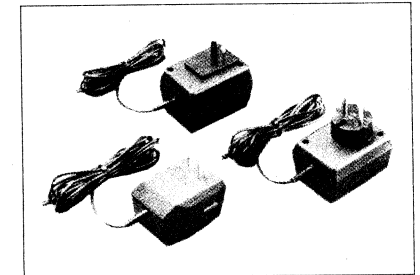

● OUT: 9VDC, 200mA

## SETTING MEMO

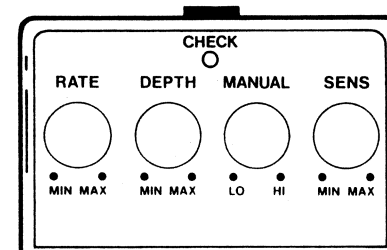
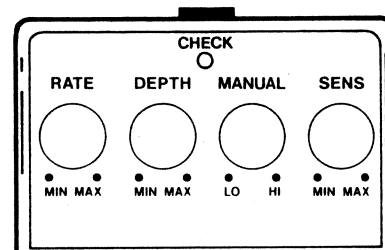
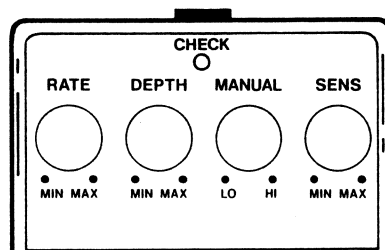
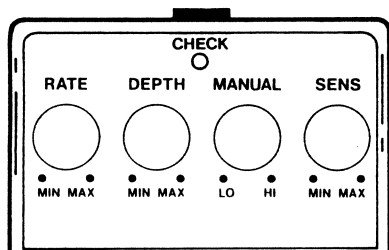
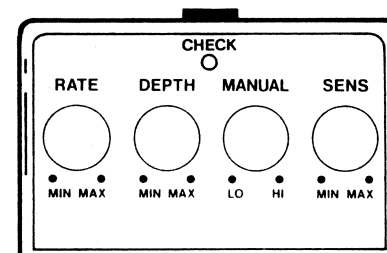
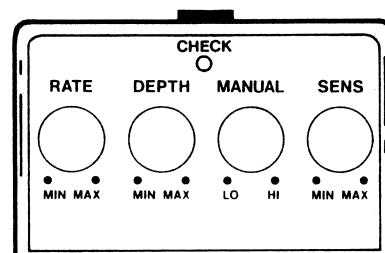
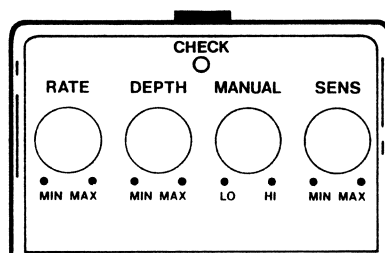
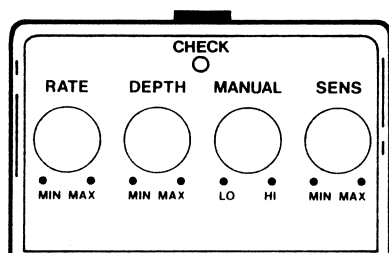

## ■ SPECIFICATIONS

**Controls** : Pedal Switch, Modulation Rate, Modulation Depth, Manual, Sens

**Indicator** : Check Indicator (serves also as battery check indicator)

**Jacks** : Input, Output, AC Adaptor

**Input Impedance** : 1M $\Omega$  (Effect Off)

**Output Impedance** : 1k $\Omega$

**Recommended Load Impedance** : 10k $\Omega$  or greater

**Residual Noise** : -80dBm or less (IHF-A, Typ.)

**Power Supply** : DC9V ; Dry Battery (9V type), AC Adaptor (PSA-120, 220 or 240 : option)

**Current Draw** : 15 mA (DC9V)

**Dimensions** : 70(W)  $\times$  125(D)  $\times$  55(H) mm / 2-3/4"  $\times$  4-15/16"  $\times$  2-3/16"

**Weight** : 420g / 1.0 lbs (including battery)

**Accessories** : Instructions, Dry Battery S-006P/9V (6F22/9V)

**Options** : AC Adaptor ; PSA-120, PSA-220, PSA-240

Dry Battery ; S-006P/9V (6F22/9V), 6AM6/9V (alkaline)

\*The specifications for this product are subject to change without prior notice.

Copyright © 1991 BOSS CORPORATION

All rights reserved. No part of this publication may be reproduced in any form without the written permission of BOSS CORPORATION.

  
Products of Roland

Printed in Taiwan 91-9-D3-110

 Roland®

26047117RT

UPC

26047117RT



19991

 **BOSS**