

# Roland®

## ADVANCED EQUALIZING PROCESSOR



# AP-700

Owner's Manual

We'd like to take a moment to thank you for purchasing the Roland AP-700 Advanced Equalizing Processor.

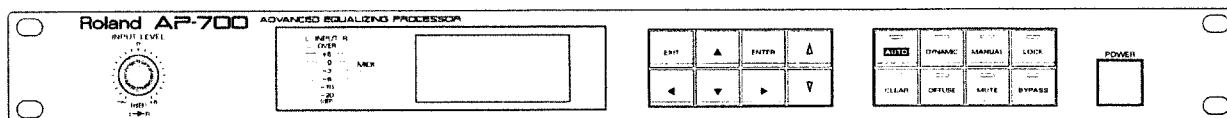
In order to fully realize the potential of the AP-700, and to ensure years of trouble-free operation, please take the time to read this manual thoroughly.



	<b>CAUTION</b> RISK OF ELECTRIC SHOCK DO NOT OPEN	
<b>ATTENTION:</b> RISQUE DE CHOC ELECTRIQUE NE PAS OUVRIR		
<b>CAUTION:</b> TO REDUCE THE RISK OF ELECTRIC SHOCK, DO NOT REMOVE COVER (OR BACK). NO USER-SERVICEABLE PARTS INSIDE. REFER SERVICING TO QUALIFIED SERVICE PERSONNEL.		



The lightning flash with arrowhead symbol, within an equilateral triangle, is intended to alert the user to the presence of uninsulated "dangerous voltage" within the product's enclosure that may be of sufficient magnitude to constitute a risk of electric shock to persons.



The exclamation point within an equilateral triangle is intended to alert the user to the presence of important operating and maintenance (servicing) instructions in the literature accompanying the product.

INSTRUCTIONS PERTAINING TO A RISK OF FIRE, ELECTRIC SHOCK, OR INJURY TO PERSONS.

## IMPORTANT SAFETY INSTRUCTIONS

### SAVE THESE INSTRUCTIONS

**WARNING** - When using electric products, basic precautions should always be followed, including the following:

1. Read all the instructions before using the product.
2. Do not use this product near water — for example, near a bathtub, washbowl, kitchen sink, in a wet basement, or near a swimming pool, or the like.
3. This product should be used only with a cart or stand that is recommended by the manufacturer.
4. This product, either alone or in combination with an amplifier and headphones or speakers, may be capable of producing sound levels that could cause permanent hearing loss. Do not operate for a long period of time at a high volume level or at a level that is uncomfortable. If you experience any hearing loss or ringing in the ears, you should consult an audiologist.
5. The product should be located so that its location or position does not interfere with its proper ventilation.
6. The product should be located away from heat sources such as radiators, heat registers, or other products that produce heat.
7. The product should be connected to a power supply only of the type described in the operating instructions or as marked on the product.
8. The power-supply cord of the product should be unplugged from the outlet when left unused for a long period of time.
9. Care should be taken so that objects do not fall and liquids are not spilled into the enclosure through openings.
10. The product should be serviced by qualified service personnel when:
  - A. The power-supply cord or the plug has been damaged; or
  - B. Objects have fallen, or liquid has been spilled onto the product; or
  - C. The product has been exposed to rain; or
  - D. The product does not appear to operate normally or exhibits a marked change in performance; or
  - E. The product has been dropped, or the enclosure damaged.
11. Do not attempt to service the product beyond that described in the user-maintenance instructions. All other servicing should be referred to qualified service personnel.

**For the USA**

This product may be equipped with a polarized line plug (one blade wider than the other) . This is a safety feature. If you are unable to insert the plug into the outlet, contact an electrician to replace your obsolete outlet. Do not defeat the safety purpose of the plug.

**For Canada**

For Polarized Line Plug

**CAUTION:** TO PREVENT ELECTRIC SHOCK, MATCH WIDE BLADE OF PLUG TO WIDE SLOT, FULLY INSERT.  
**ATTENTION:** POUR ÉVITER LES CHOCs ÉLECTRIQUES, INTRODUIRE LA LAME LA PLUS LARGE DE LA FICHE DANS LA BORNE CORRESPONDANTE DE LA PRISE ET POUSSER JUSQU' AU FOND.

**For the U.K.**

**IMPORTANT:** THE WIRES IN THIS MAINS LEAD ARE COLOURED IN ACCORDANCE WITH THE FOLLOWING CODE.

BLUE: NEUTRAL  
 BROWN: LIVE

As the colours of the wires in the mains lead of this apparatus may not correspond with the coloured markings identifying the terminals in your plug, proceed as follows:

The wire which is coloured BLUE must be connected to the terminal which is marked with the letter N or coloured BLACK.  
 The wire which is coloured BROWN must be connected to the terminal which is marked with the letter L or coloured RED.  
 Under no circumstances must either of the above wires be connected to the earth terminal of a three pin plug.

# Table of Contents

<b>Main Features</b> .....	4	<b>Section 5: Editing</b> .....	
<b>Important Notes</b> .....	4	<b>Editing in the AFB Mode</b> .....	17
<b>Overview of the AP-700</b> .....	5	Quick Edit .....	17
<b>How to Use This Manual</b> .....	5	HPF and LPF Settings .....	18
<b>Part Names and Functions</b> .....	6	Initializing the AFB Mode .....	18
<b>Section 1: Basic Operation</b> .....		Auto Function .....	18
<b>Making the Connections</b> .....	7	Dynamic Function .....	19
Use with a Specific Microphone or Instrument .....	7	Diffuse Function .....	19
Use with an Entire PA System .....	8	Mute Function .....	19
Use in the AFB Mode .....		<b>Editing in the PEQ Mode</b> .....	19
with a Number of Microphones .....	8	HPF and LPF Settings .....	19
<b>Powerup and Standby</b> .....	8	Initializing the PEQ Mode .....	19
Switching On the Power .....	8	<b>Editing in the GEQ Mode</b> .....	20
Adjusting the Input Level .....	8	HPF and LPF Settings .....	20
Bypass .....	9	Initializing the GEQ Mode .....	20
Lock .....	9	<b>Common Operations for All Modes</b> .....	20
<b>Choosing Parameters</b> .....	9	HPF and LPF Settings (Common for All Modes) .....	20
About the Notation for Parameter Selection .....	9	Zoom/Scroll for the Display .....	
<b>Choosing the Mode</b> .....	10	(Common for All Modes) .....	21
<b>Section 2: How to Use the AFB Mode</b> .....		<b>Editing System Parameters</b> .....	21
<b>About the AFB Mode</b> .....	11	Audio I/O (Audio Input and Output) .....	21
Functions of the AFB Mode .....	11	Delay .....	22
About the Display on the Analyzer/Filter Screen .....	11	Displaying the Software Version .....	22
Basic Usage .....	12	Displaying Temporary Information .....	22
Manual On/Off Switching .....	13	Adjusting the Contrast of the Display .....	22
Mute .....	13	Initialize .....	22
Switching the Display (FILTER and ANALYZE) .....	13	<b>Memory Function</b> .....	23
Zoom/Scroll for the Display .....	13	Storing Settings (Save) .....	23
<b>Section 3: How to Use the PEQ Mode</b> .....		Calling Up a Patch (Load) .....	23
<b>About the PEQ Mode</b> .....	14	<b>Section 6: How to Use MIDI</b> .....	
About the Display on the Analyzer/Filter Screen .....	14	<b>What Can You Do with MIDI?</b> .....	24
Basic Usage .....	14	<b>Settings for MIDI Functions</b> .....	24
Switching the Display .....		<b>Settings for the Program Change Map</b> .....	24
(FILTER, 91BAND, and 31BAND) .....	15	<b>Settings for the Control Change Map</b> .....	25
Zoom/Scroll for the Display .....	15	<b>Sending Data (Bulk Dump)</b> .....	25
<b>Section 4: How to Use the GEQ Mode</b> .....		<b>Receiving Data (Bulk Load)</b> .....	26
<b>About the GEQ Mode</b> .....	16	<b>Section 7: Supplementary Materials</b> .....	
About the Display on the Filter Screen .....	16	<b>If You Think There May Be a Problem,</b>	
Basic Usage .....	16	<b>Check Here First</b> .....	27
Zoom/Scroll for the Display .....	16	<b>List of Display Messages</b> .....	27
<b>Section 5: Editing</b> .....		<b>About Digital Input and Output</b> .....	28
<b>Editing in the AFB Mode</b> .....	17	About Channel Status .....	28
Quick Edit .....	17	Important Points When Using Digital Input .....	28
HPF and LPF Settings .....	18	<b>Equalizer Characteristics</b> .....	29
Initializing the AFB Mode .....	18	<b>Parameter Table</b> .....	35
Auto Function .....	18	<b>MIDI Implementation Chart</b> .....	36
Dynamic Function .....	19	<b>Main Specifications</b> .....	37
Diffuse Function .....	19	<b>Index</b> .....	38
Mute Function .....	19		

Copyright © 1995 Roland Corporation

All rights reserved. No part of this publication may be reproduced in any form without the written permission of ROLAND CORPORATION.

---

## Main Features

### Anti-Feedback Mode

Points where feedback (howling) occurs are detected automatically, and a selected filter is applied to the frequency response at those points to eliminate the feedback.

### 18-Band Parametric Equalizer Mode

You can use the AP-700 as a parametric equalizer with up to 18 bands. Curves showing frequency response appear on the display.

### Graphic Equalizer Mode

This mode makes it possible to use the AP-700 as a 91-band monaural equalizer or a 31-band stereo equalizer. The equalizer settings can be confirmed on the display as they are made.

### Spectrum Analyzer Function

The AP-700 features a spectrum analyzer function. This works as a 91-band analyzer, showing the level of each band on the display (not available in the GEQ mode).

### Diffuse Function

This applies a slow modulation that is inaudible to the human ear to help suppress feedback and coloration (AFB mode only).

### High-Pass Filter (HPF) and Low-Pass Filter (LPF)

The HPF and LPF can be used to cut unwanted frequency bands.

### Digital I/O Jacks

The AP-700 is equipped with cannon type digital I/O jacks that conform to AES/EBU standards.

## Important Notes

In addition to the items listed under Safety Precautions inside the front cover, please read and observe the following:

### Power Supply

- Before connecting this unit to other devices, turn off the power to all units; this will help prevent damage or malfunction.
- Do not use this unit on the same power circuit with any device that will generate line noise; an electric motor or variable lighting system for example.

### Placement

- Using the unit near power amplifiers (or other equipment containing large power transformers) may induce hum.
- This device may interfere with radio and television reception. Do not use this device in the vicinity of such receivers.

### Maintenance

- For everyday cleaning wipe the unit with a soft, dry cloth or one that has been slightly dampened with water. To remove stubborn dirt, use a mild, non-abrasive detergent. Afterwards, be sure to wipe the unit thoroughly with a soft, dry cloth.
- Never use benzene, thinners, alcohol or solvents of any kind, to avoid the possibility of discoloration and/or deformation.

### Additional Precautions

- Protect the unit from strong impact.
- A small amount of heat will radiate from the unit during normal operation.
- Before using the unit in a foreign country, consult with qualified service personnel.

### Memory Backup

- This unit contains a battery which powers the unit's memory circuits while the main (AC) power is off. The expected life of this battery is 3 years or more. However, to avoid the untimely loss of memory data, it is strongly recommended that you change the battery every 3 years. Please be aware that the actual life of the battery will depend upon the physical environment — especially the temperature — in which the unit is used. When it is time to change the battery, consult with qualified service personnel.
- When the battery becomes weak the following message will appear in the display: "Battery Low Please Change." Please change the battery as soon as possible to avoid the loss of memory data.
- Please be aware that the contents of memory may at times be lost; when the unit is sent for repairs or when by some chance a malfunction has occurred. Important data should be stored in another MIDI device (eg., a sequencer), or written down on paper (if possible). During repairs, due care is taken to avoid the loss of data. However, in certain cases (such as when circuitry related to memory itself is out of order), we regret that it may not be possible to restore the data.

---

## Overview of the AP-700

The AP-700 is equipped with the following three modes. Select the mode according to what you wish to do. See "Choosing the Mode" (p. 10) if you need more information on how to select a mode.

### **AFB (Anti-Feedback) Mode**

This mode is used to eliminate feedback (howling) generated in a sound reinforcement system where a microphone is in use.

### **PEQ (Parametric Equalizer) Mode**

This functions as a parametric equalizer that allows settings for up to 18 bands. You can set the frequency, Q, and level for each band.

### **GEQ (Graphic Equalizer) Mode**

This mode allows use as a 91-band monaural or 31-band stereo equalizer. The equalizer settings can be confirmed on the display as they are made.

## How to Use This Manual

This manual is divided into two parts: items that are common to all modes, and items that are required for individual modes.

At the end of the manual there is an alphabetical index. This index may be helpful if you come across any words you don't understand as you follow the procedures described in this manual.

Here is what is covered in each of the sections.

### **Section 1: Basic Operation**

---

This section explains installation and operation procedures that are common to all of the modes.

### **Section 2: How to Use the AFB Mode**

---

This section provides an overview of the AFB mode and describes its steps of operation.

### **Section 3: How to Use the PEQ Mode**

---

This section describes the steps of operation for the PEQ mode.

### **Section 4: How to Use the GEQ Mode**

---

This section describes the steps of operation for the GEQ mode.

### **Section 5: Editing**

---

This section describes the parameters that can be changed in each mode, and explains how to make these changes.

### **Section 6: How to Use MIDI**

---

This section explains how to control the AP-700 when using an external MIDI instrument, and how to send and receive MIDI data. You should read this section if you want to make use of MIDI functions.

### **Section 7: Supplementary Materials**

---

This section provides a list of the messages that appear during operation, and explains what each means. It also contains materials on the specifications of the AP-700.

# Part Names and Functions

## Front Panel

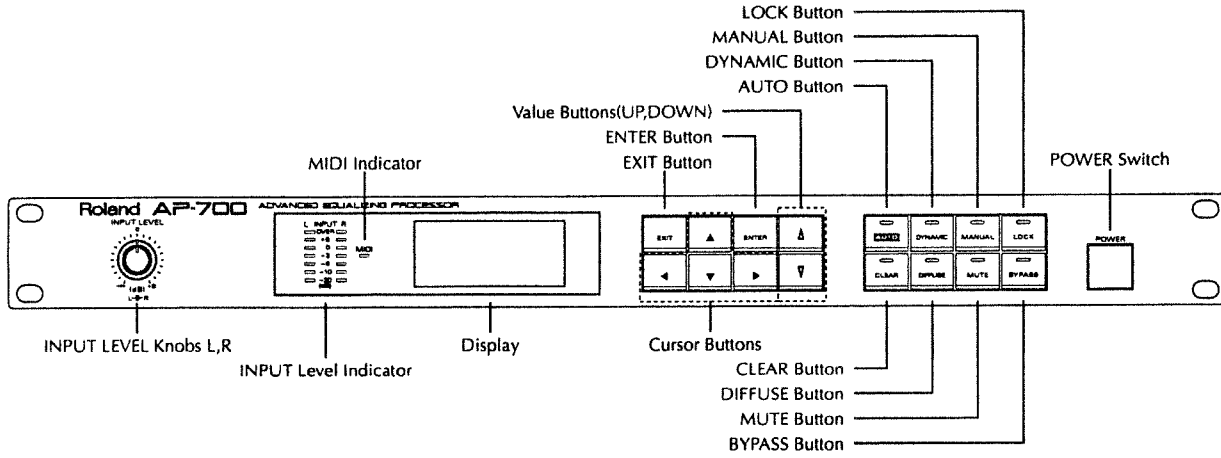

## Rear Panel

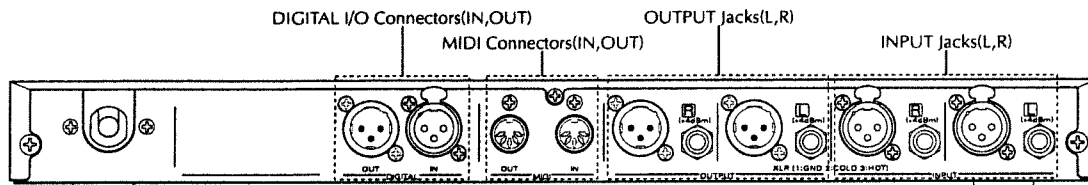

# Section 1: Basic Operation

## Making the Connections

The AP-700 can be connected up in various ways depending on how it is to be used. Refer to the example setups that are given in the following.

- \* When making the connections, be sure that the volume on your amp is turned down all the way, and that all equipment is switched off. Equipment may be damaged if connected while the power is on.
- \* Set the input and output level for the equipment being connected to "+4 dBm."
- \* For the input jacks, the 1/4 inch phone jacks take priority over other types.
- \* Do not connect the AP-700 to the output of a power amp.
- \* The 1/4 inch phone jacks support balanced input using a stereo plug.

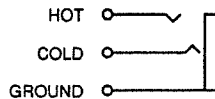

- \* The pin assignment for the XLR connectors is as follows: Before making any connections, confirm pin assignment compatibility with all other devices.

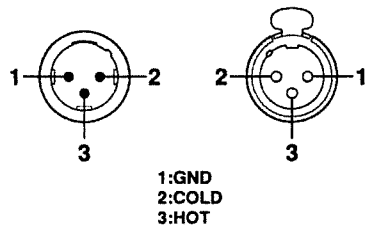

## Use with a Specific Microphone or Instrument

This is an example of a connection that uses the AP-700 with only a specific microphone or instrument.

When connecting the microphone to the AP-700, make the connection through a preamp or use the channel insertion for a mixer to match up the input and output levels for the connection.

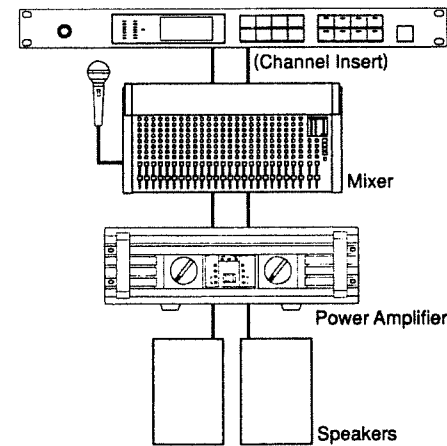
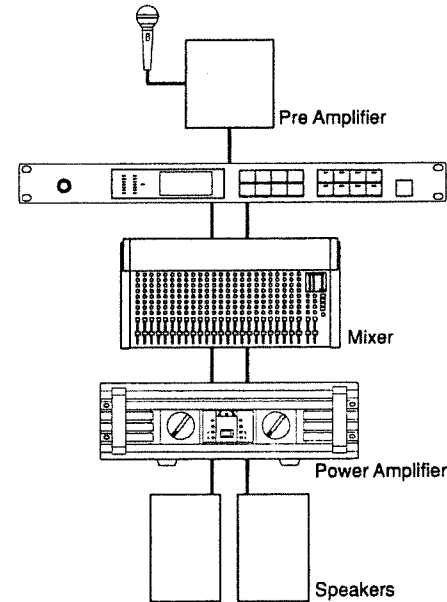

- \* You will not be able to obtain the intended results if a microphone is connected directly to the AP-700.

## Use with an Entire PA System

When using the AP-700 with all of the equipment that is connected to the mixer, connect the output from the mixer to the AP-700.

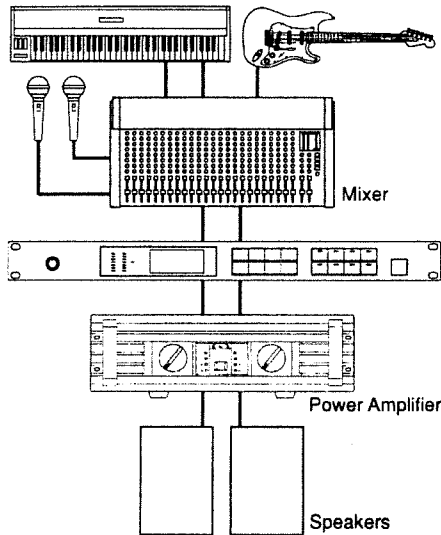

## Use in the AFB Mode with a Number of Microphones

Mix all of the microphones with a small mixer before they connect with the AP-700.

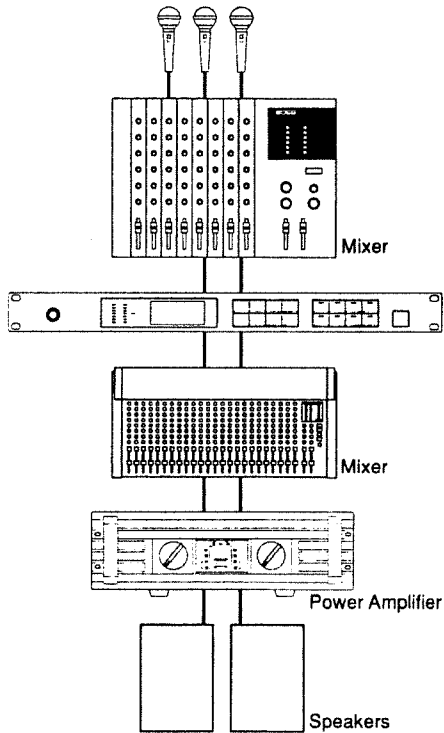

## Powerup and Standby

### Switching On the Power

First check the connections with the external equipment, and then switch on the AP-700.

The display flashes, and the AP-700 returns to the state in effect when the power was last switched off.

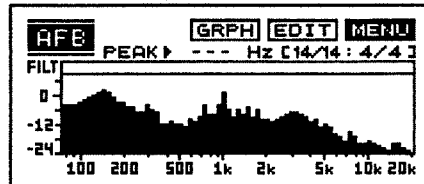

- \* Adjust the volume for the amp after switching on all other equipment.
- \* To protect its internal circuitry, the AP-700 will not function for a short while after the power is switched on.
- \* When the power is not on, signals input to the AP-700 are output without change.
- \* The display may be hard to make out when installed in certain positions. If this is the case, adjust the contrast of the display (p. 22).

### Adjusting the Input Level

The INPUT LEVEL knob should normally be left at "0" during use. The "0" position is for uni-gain, so the input and output levels will be identical.

You will need to use the INPUT LEVEL knob to adjust the input level if the "OVER" segments in the level indicator light up, or if the input level is too low.

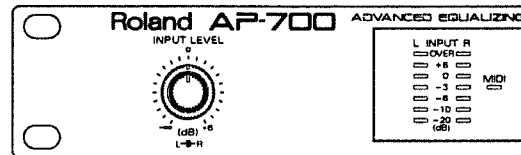

- \* The input levels for the left and right channels can be set independently.



## Bypass

If you want direct output of the input sound, turn on Bypass.

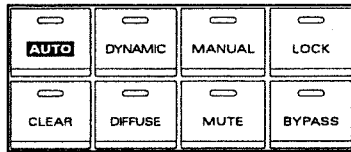

Each press of the [BYPASS] button toggles Bypass on or off. The button's indicator lights up when Bypass is on.

\* In the AFB mode, be sure to turn down the volume for your speaker system to a low enough level before turning on Bypass, or feedback (howling) may occur.

## Lock

The Lock function can be switched on to protect the settings and prevent them from being changed if the panel buttons are inadvertently pressed.

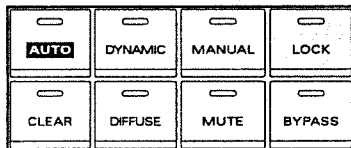

### To switch on the Lock:

Hold down the [LOCK] button for more than two seconds. The button's indicator lights up and the unit is locked.

### To release the Lock:

Hold down the [LOCK] button for more than two seconds. The button's indicator goes out and the lock is released.

## Choosing Parameters

You can change the functioning of the AP-700 by varying the parameter settings.

Here's how to choose the desired parameter and change its setting.

1. Use the cursor buttons and the (ENTER) button to switch parameters until the desired parameter appears on the display.
2. When the parameter you want is shown on the display, move the cursor to the parameter.
3. Use the VALUE buttons to change the setting.

## About the Notation for Parameter Selection

The explanations in this manual skip a description of the procedure you need to follow to show the desired parameter on the display.

Example: Adjusting the HPF Frequency for the AFB Mode

**MENU ▶ AFB mode ▶ HPF/LPF▶**

The actual operation for this procedure is as follows.

1. Use the cursor buttons to move the cursor to (MENU), then press (ENTER).

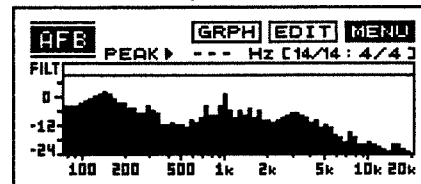

2. Use the cursor buttons to move the cursor to (AFB mode) and press (ENTER).

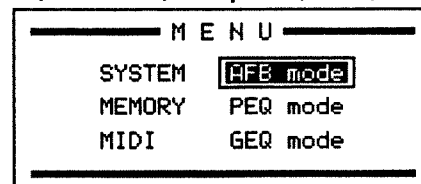

3. Use the cursor buttons to move the cursor to (HPF/LPF) and press (ENTER).

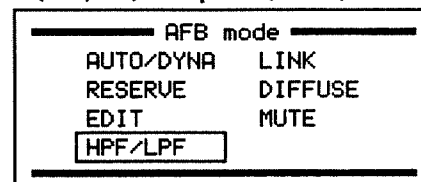

4. Use the cursor buttons to move the cursor to the HPF frequency and adjust the setting with the VALUE buttons.

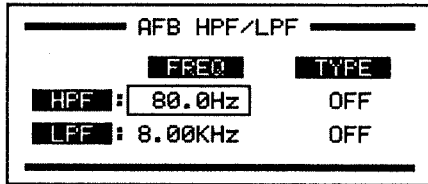

- \* The starting point for these operations is the Analyzer/Filter screen. No matter what mode you're in, you can get to the Analyzer/Filter screen by pressing the [EXIT] button repeatedly — the Analyzer/Filter screen is the last screen to appear.
- \* This manual contains a "Parameter Table" that shows the structure of the parameters.
- \* Manipulation of a setting causes the contents of the setting to switch with each change.
- \* Each press of the [EXIT] button causes the display to go back one screen. The contents of settings (or changes) are retained.

## Choosing the Mode

Choose whichever one of the three modes that you wish to use.

### MENU ▶

The mode that is highlighted in the display is the currently selected mode.

1. Using the cursor buttons, move the cursor to (MENU), then press (ENTER).

2. Move the cursor to the mode you want to use.

- AFB mode: AFB (Anti-Feedback) mode
- PEQ mode: PEQ (Parametric Equalizer) mode
- GEQ mode: GEQ (Graphic Equalizer) mode

3. Press (ENTER).

As shown below, a message asking you to confirm the change in mode appears on the display. (The actual message varies according to the modes being changed.)

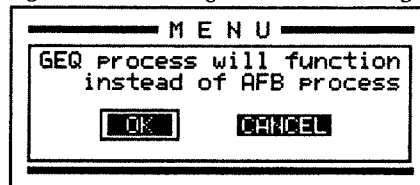

4. Press (ENTER) to go ahead and change the mode. If you want to start over, move the cursor to (CANCEL) and press (ENTER).

## Section 2: How to Use the AFB Mode

### About the AFB Mode

The AFB mode uses a filter with an extremely high Q to eliminate feedback (howling) occurring in a sound reinforcement system that uses a microphone, and keep fluctuations in the sound quality to a minimum.

The AFB mode performs compensation to minimize fluctuations in sound quality, but this does not mean that no changes at all occur in the sound quality. As the number of points at which feedback-suppression points increases, the sound quality also gradually changes. Fluctuations in sound quality can be kept to a minimum by using the AFB mode after first positioning the sound reinforcement device so as to reduce the chance of feedback occurring.

### Functions of the AFB Mode

The AFB mode offers the following functions for eliminating feedback.

#### • Auto Function

This function is suited to eliminating feedback during sound checks.

The Auto function automatically searches for the feedback point (the frequency at which feedback occurs), and sets up a filter to correct the frequency response at that point and eliminate feedback.

#### • Dynamic Function

This function eliminates sudden feedback occurring because of changes in the sound production environment, or other factors such as the microphone being moved. Like the Auto function, the Dynamic function is automatic.

#### • Manual Function

The Manual function can be used to switch filters on or off.

#### • Diffuse Function

The Diffuse function applies slow, inaudible modulation to suppress feedback and coloration.

This function is particularly effective in suppressing feedback and coloration in the treble range.

#### • Mute Function

The Mute function can be switched on when you want to lower the output level. Parameters for setting the mute level are available.

In addition to these five functions, the AFB mode also offers the following functions.

#### • Spectrum Analyzer

This works as a 91-band analyzer, showing the frequency response of the input sound on the display. Zoom and Scroll can be used to switch the frequency range or level being monitored.

#### • High-Pass Filter (HPF) and Low-Pass Filter (LPF) Settings

These allow the AFB mode to be used more effectively in the required frequency bands by cutting unnecessary frequency bands.

### About the Display on the Analyzer/Filter Screen

The following information appears on the Analyzer/Filter screen for the AFB mode.

"AUTO": The Auto function is in operation

"DYNA": The Dynamic function is in operation

"AFB": A function other than the foregoing two is in operation (AFB mode)

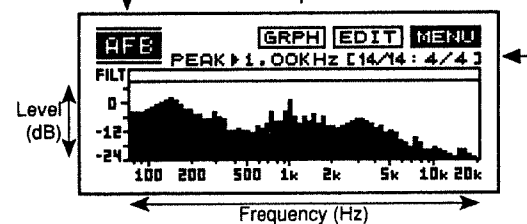

"AUTO"

Example: A-1 1.00 kHz -3.0 dBm 13/14  
Filters set by the Auto function, and numbers of remaining/reserve filters

"DYNA"

Example: D-1 1.00 kHz -3.0 dBm 3/4  
Filters set by the Auto function, and numbers of remaining/reserve filters

"AFB"

Example: PEAK 1.00 kHz [14/14 : 4/4]  
Peak point and numbers of remaining/reserve filters(Auto:Dynamic)

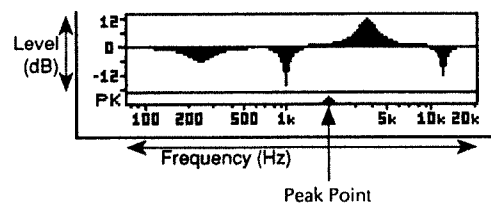

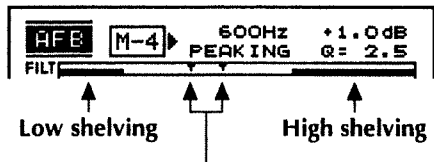

Display of the center frequency for the peaking filter

## Basic Usage

This section describes the simple steps that are needed for operation using the AFB mode.

Practical applications such as independent use for the left and right channels (Link Off), as well as the following items, are described in "Section 5: Editing." Take a look at that section if this is what you need.

### Quick Edit

#### HPF and LPF settings

#### Initialization

In the steps described below, it is assumed that you have already set up and connected your equipment. Also, check to make sure that the indicators for the [BYPASS] and [MUTE] buttons are not lit up. If either one is lit, press the corresponding button to make the indicator go out.

### 1. Clear any filters set by the Auto function.

You can skip this step if the indicator for the [CLEAR] button is lit up.

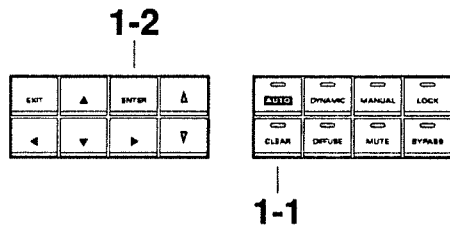

#### 1-1 Press (CLEAR).

The display changes to show a message confirming that the filters set by the Auto function are to be cleared.

#### 1-2 To clear the filters, press (ENTER). If you want to start over, move the cursor to (CANCEL) and press (ENTER).

The indicator for the [CLEAR] button lights up. All filters set by the Auto function are cleared.

### 2. Eliminate feedback with the Auto function.

#### 2-1,2-3

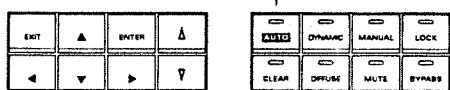

#### 2-1 Press (AUTO) once.

The button's indicator flashes to show that the Auto function is working.

#### 2-2 Gradually increase the volume of the sound reinforcement system.

As the volume rises and feedback occurs, the AFB mode's Auto function automatically sets up filters and eliminates the feedback. The indicator for the [CLEAR] button goes out as soon as even one filter is set.

#### 2-3 Increase the volume to the desired level and press (AUTO).

The indicator for the [AUTO] button goes out and the Auto function is ended.

You can change the settings for the filters set by the Auto function. The way to do this is the same as for Quick Edit. See "Quick Edit" (p. 17) for details.

### 3. Use the Dynamic function to guard against sudden feedback.

Even after feedback has been eliminated by the Auto function, feedback may still occur because of changes in the sound production environment, or if a microphone is moved. To take care of this, you can suppress sudden feedback with the Dynamic function while leaving the settings for the Auto function in place.

- When the number of filters that the Dynamic function sets up exceeds its pre-assigned number of filters, the Dynamic function clears the first filter in order to set up a new one.
- All filters established by the Dynamic function are cleared when the function is switched off.

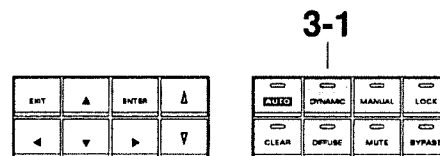

#### 3-1 Press (DYNAMIC) once.

The button's indicator lights up to show that the Dynamic function is working.

Each press of the [DYNAMIC] button toggles the Dynamic function on or off. When the Dynamic function is on, its button indicator lights up.

If feedback occurs, the Dynamic function automatically compensates the frequency response and eliminates the feedback.

#### 4. Use the Diffuse function.

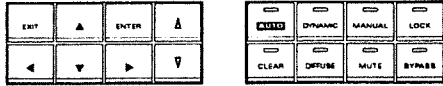

4-1

4-1 Press (DIFFUSE) once.

The button's indicator lights up to show that the Diffuse function is working.

Each press of the [DIFFUSE] button toggles the Diffuse function on or off. When the Diffuse function is on, its button indicator lights up.

#### Manual On/Off Switching

You can use the Manual function to switch on or switch off the filters that have been set.

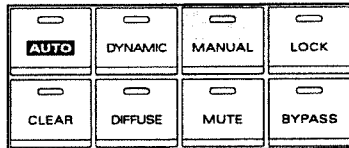

Each press of the [MANUAL] button toggles the Manual function on or off. When the Manual function is on, its button indicator lights up.

\* The steps for setting filters used by the Manual function are described in "Quick Edit" (p. 17).

#### Mute

Switch on Mute when you want to lower the output level.

The mute level can be adjusted to match the desired usage. See "Mute Function" (p. 19) for an explanation of how to make the settings.

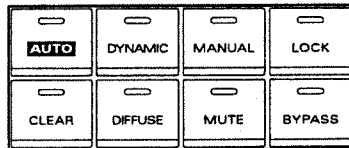

Each press of the [MUTE] button toggles the Mute function on or off. When the Mute function is on, its button indicator lights up.

#### Switching the Display (FILTER and ANALYZE)

The AFB mode not only lets you display a 91-band spectrum analyzer showing the frequency response for input sound, it also lets you switch to a display of filter characteristics.

#### GRPH ► SELECT ►

**FILTER:** Shows filter characteristics on the display.

**ANALYZE:** Shows the frequency response of input sound on the display as a 91-band spectrum equalizer.

#### Zoom/Scroll for the Display

The display's Zoom and Scroll functions work the same in every mode. See "Zoom/Scroll for the Display (Common for All Modes)" (p. 21) for a description of the steps to use.

# Section 3: How to Use the PEQ Mode

## About the PEQ Mode

This mode lets you use the AP-700 as a stereo parametric equalizer with 18 bands per channel, and allows you to set the frequencies, Q values, and levels for each band. The contents of the settings can be viewed and confirmed in the form of frequency response curves appearing on the display. You can also use the HPF and LPF independently of the parametric equalizer.

## About the Display on the Analyzer/Filter Screen

The following information appears on the Analyzer/Filter screen for the PEQ mode.

### Filter screen

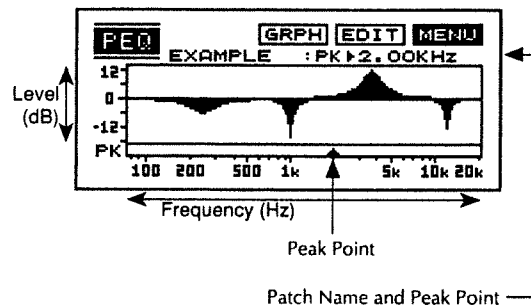

### Analyzer screen

Display of the center frequency for the peaking filter

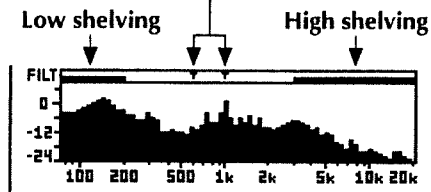

## Basic Usage

This section describes the simple steps that are needed for operation using the PEQ mode.

Practical applications such as independent use for the left and right channels (Link Off), as well as the following items, are described in "Section 5: Editing." Take a look at that section if this is what you need.

### HPF and LPF settings

#### Initialization

EDIT ▶

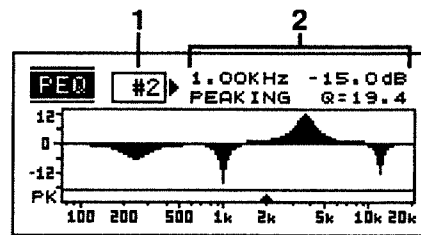

1. Use the cursor buttons to move the cursor to the band number, then use the (VALUE) buttons to select the band you want to modify.
2. Use the cursor buttons to move the cursor to the parameter you want to modify, then use the (VALUE) buttons to change the setting.

You can repeat steps 1 and 2 to change the settings for all the band numbers.

### [BAND NUMBER] (1 to 18)

This selects the band that is to be set. The parameters for the selected band appear in the display.

### [FILTER TYPE]

(PEAKING, LOW SHELVING, or HIGH SHELVING)

This selects the type of filter.

**PEAKING:** Sets Frequency, Q, and level as a parametric type equalizer.

**LOW SHELVING:** Sets frequency and level as a low-shelving type equalizer.

**HIGH SHELVING:** Sets frequency and level as a high-shelving type equalizer.

### [FREQUENCY] (19.7 Hz to 20.2 kHz)

This sets the center frequency for the filter.

### [Q] (0.3 to 100)

This sets the range over which the filter is applied, centering on the frequency set with "FREQUENCY."

Larger values for Q result in steeper filter characteristics.

\* The Q value is ignored when "LOW SHELVING" or "HIGH SHELVING" is selected as the filter type.

---

**[LEVEL]** (-40.0 to +12.0 dB)

This sets the filter level (amount of boost or cut).

- In the PEQ mode, settings can also be made within a screen called up (using the following procedure) from the Analyzer/Filter screen.

**MENU ▶ PEQ mode ▶ EDIT ▶**

### **Switching the Display (FILTER, 91BAND, and 31BAND)**

The PEQ mode not only lets you display a 31- or 91-band spectrum analyzer showing the frequency response for input sound, it also lets you display filter characteristics.

**GRPH ▶ SELECT ▶**

- FILTER:** Shows filter characteristics on the display.
- 91BAND:** Displays the frequency response of input sound on the display as a 91-band spectrum equalizer.
- 31BAND:** Displays the frequency response of input sound on the display as a 31-band spectrum equalizer.

### **Zoom/Scroll for the Display**

The Zoom and Scroll functions for the display work the same in every mode. See "Zoom/Scroll for the Display (Common for All Modes)" (p. 21) for a description of the steps to use.

# Section 4: How to Use the GEQ Mode

## About the GEQ Mode

This mode enables use as a 91-band mono or 31-band stereo graphic equalizer. You can make the settings for the equalizer as you view them on the display. You can also use the HPF and LPF independently of the graphic equalizer.

### About the Display on the Filter Screen

The following information appears on the Filter screen for the GEQ mode.

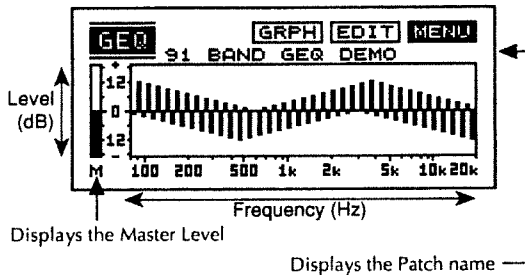

### Basic Usage

This section describes the simple steps that are needed for operation using the GEQ mode.

Practical applications such as independent use for the left and right channels (Link Off), as well as the following items, are described in "Section 5: Editing." Take a look at that section if this is what you need.

#### HPF and LPF settings

##### Initialization

#### • Master Level Setting

This sets the amount of boost or cut for the overall output level (master level) of the equalizer.

EDIT ► MSTR ►

Use the (VALUE) buttons to set the master level.

#### • Level Settings for Each Band (Frequency)

This adjusts the level (amount of boost or cut) for each of the bands.

EDIT ► BAND ►

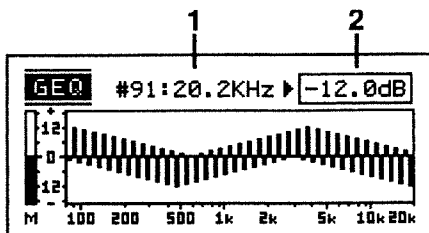

1. Use the cursor buttons to move the cursor to the band (frequency), then use the (VALUE) buttons to select the band.

2. Use the cursor buttons to move the cursor to the level, and adjust the level with the (VALUE) buttons.

You can repeat steps 1 and 2 to set the level for all bands.

[LEVEL] (-12.0 to +12.0 dB)

This sets the level (amount of boost or cut).

#### • Setting the Level Curve Automatically

The AP-700 comes with a function that lets you select a starting band, ending band, and level, then automatically sets a smooth level for the range between the starting and ending bands.

EDIT ► FORM ►

1. Choose the starting (upper) and ending (lower) bands (frequencies).

The current levels will be shown.

2. Set the level for the starting (upper) and ending (lower) points.

3. Move the cursor to where the type (one of three below) is displayed and change it, if necessary, using (VALUE).

LINE: Linearly connects the starting and ending points.

CURVE: Connects the starting and ending points with a smooth curve. The curve will change depending on the settings.

UNDO: Returns the AP-700 to the state before making automatic settings.

4. Press (ENTER) to set the equalizer to work automatically.

To cancel what has been automatically set up, perform an "UNDO." This will put the unit back into the status it was in before it was set to work automatically.

\* In the GEQ mode, settings can also be made at the screen called up by using the following procedure.

MENU ► GEQ mode ► EDIT ►

### Zoom/Scroll for the Display

The Zoom and Scroll functions for the display work the same in every mode. See "Zoom/Scroll for the Display (Common for All Modes)" (p. 21) for a description of the steps to use.



## Section 5: Editing

This section describes the parameters that can be changed (edited) in the different modes, and explains how to make these changes -- in other words, how to edit.

### Editing in the AFB Mode

#### Quick Edit

When you use the AP-700 in the AFB mode, filters are set manually. You can also use the same procedures to modify filters set by the Auto function.

- \* Filters produced by the Dynamic function cannot be modified.

#### EDIT ►

1. Move the cursor to the filter number and use the (VALUE) buttons to select the filter number you wish to modify.

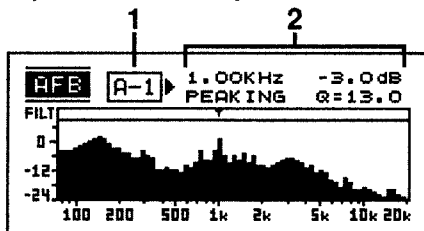

2. Use the cursor buttons to move the cursor to the parameter you want to work with, and make the settings with the (VALUE) buttons.

If you modify the parameters for a filter that was set by the Auto function, the filter number is highlighted (inversed), indicating that the setting has been modified. Also, when feedback occurs at the same frequency as a modified filter, the feedback is eliminated by a different filter set to the same frequency.

**You can repeat steps 1 and 2 to set the parameters for all filters.**

- \* Settings for the filters can also be made in the screen called up by using the following procedure.

#### MENU ► AFB mode ► EDIT ►

#### [FILTER NUMBER] (A1 to A18 and M1 to M18)

This selects the filter to be set. The parameters for the chosen filter appear on the display.

A: Displays a filter set by the Auto function.

M: Displays a filter toggled on or off by the Manual function.

- \* A filter set by the Auto function can be made into a Manual function filter, and a filter reserved for the Manual function can also be made into a filter reserved for the Auto function. This change is made by selecting the filter number to be changed and pressing [ENTER]. When you do this, a message asking you to confirm the change appears on the display. Press [ENTER] to change the Auto or Manual function. If you want to start over, move the cursor to [CANCEL] and press [ENTER].

If you choose not to make the above change, only the parameters will be changed.

(If a change has been made in the reservations, the filters numbers will be rearranged.)

#### [FILTER TYPE]

(PEAKING, LOW SHELVING, or HIGH SHELVING)

This selects the type of filter.

PEAKING: Sets Frequency, Q, and level as a parametric type equalizer.

LOW SHELVING: Sets frequency and level as a low-shelving type equalizer.

HIGH SHELVING: Sets frequency and level as a high-shelving type equalizer.

- \* The type of a filter reserved for the Auto function is fixed at "PEAKING" and cannot be changed.

#### [FREQUENCY] (19.7 Hz to 20.2 kHz)

For a parametric type filter, this sets the center frequency. With a shelving type filter, this sets the frequency at which the filter begins to be applied.

#### [Q] (0.3 to 100)

This sets the range over which the filter is applied, centering on the frequency set with "FREQUENCY."

Larger values for Q result in steeper filter characteristics.

- \* The Q value for a filter set by the Auto function is set automatically according to the level. However, this parameter can be used to change the value set for Q.

- \* The Q value is not displayed when "LOW SHELVING" or "HIGH SHELVING" is selected for Filter Type.

#### [LEVEL] (AUTO: -40.0 to 0.0 dB; MANUAL: -40.0 to +12.0 dB)

This sets the filter level (amount of boost or cut).

- \* Setting the level to "0 dB" clears the filter.

---

## HPF and LPF Settings

The same procedure is used in each mode to make the settings for the HPF and LPF. See "HPF and LPF Settings (Common for All Modes)" (p. 20) for a description of this procedure.

## Initializing the AFB Mode

This initializes the AFB mode. There are parameters that initialize the entire AFB mode, as well as parameters that initialize individual functions.

**[FILTER RESERVE: Number of Reserved Filters]**  
(AUTO: 0 to 18, DYNAMIC: 0 to 18)

**MENU ▶ AFB mode ▶ RESERVE ▶**

The number of filters that can be used simultaneously is a total of 18 bands for each channel. This parameter sets how the 18 bands are allocated to the three functions (A – Auto, D – Dynamic, and M – Manual). The number of filter bands that can be set with each function is within the value set here.

**[LINK] (ON or OFF)**

**MENU ▶ AFB mode ▶ LINK ▶**

This makes the setting for linking the channels.

**ON:** The two channels operate in the same way.

**OFF:** The channels operate independently. Because all settings are independent, separate settings are made for each channel.

### •When Link Is Switched from OFF to ON

This sets which channel – left or right – will serve as the basis for the settings that are applied commonly to both channels when Link is set to ON.

**L CH:** The settings for the left channel become the common settings for both channels.

**R CH:** The settings for the right channel become the common settings for both channels.

### •When Link Is Switched from ON to OFF

This sets which channel – left or right – is affected by panel operations for the Auto or Dynamic functions.

**L CH:** Settings affect only the left channel.

**R CH:** Settings affect only the right channel.

**L+R CH:** Settings affect both the left and right channels.

\* Settings made here can be switched from the Analyzer/Filter screen.

### •Operation When Link Is Set to OFF

Because the channels act independently when Link is set to OFF, the following settings are possible.

#### Selecting the Channel to Edit

This selects the channel affected by panel operations. The current setting is shown on the Analyzer/Filter screen.

**L CH:** Panel operations affect only the left channel.

**R CH:** Panel operations affect only the right channel.

**L+R CH:** Panel operations affect both the left and right channels.

To change the channel setting, move the cursor to the channel display ("L CH," "R CH," or "L+R CH"), and press [ENTER]. This switches you to the setting screen.

#### Filter Operation During a Quick Edit Session

The channel ("L" or "R") appears to the left of the filter number.

## Auto Function

This perform initialization when using the Auto function.

**[STEP] (0.5 to 40.0 dB)**

**MENU ▶ AFB mode ▶ AUTO/DYNA ▶**

This adjusts the amount of change in the level that takes place at one time for the filter suppressing feedback (howling). If the amount of change is small, some time is required to suppress feedback, but changes in sound quality can be reduced. A large amount of change allows feedback to be suppressed quickly, but sound quality may change considerably.

**[RESPONSE] (SLOW1 to FAST10)**

**MENU ▶ AFB mode ▶ AUTO/DYNA ▶**

This adjusts the time until a signal above the threshold is recognized as feedback (howling). Settings close to "Fast" result in signals above the threshold being recognized as feedback in a more immediate manner. Conversely, settings close to "SLOW" result in a slower response. If you should obtain undesirable results, such as when there is frequent noise at the mike, it can be set to "SLOW."

**[THRESHOLD] (–60.0 to +20.0 dB)**

**MENU ▶ AFB mode ▶ AUTO/DYNA ▶**

This adjusts the level at which the Auto function recognizes the input signal as feedback (howling).

If the input level rises above the threshold, the input signal is considered to be feedback and the frequency response is corrected.

---

**[MARGIN]** (0.0 to +12.0 dB)

**MENU ▶ AFB mode ▶ AUTO/DYNA ▶**

When the Auto function is searching for a feedback point (in other words, during operation of the Auto function), the output level can increase by only the level set here.

When the Auto function is exited, the level returns to its original value, providing a margin against feedback.

## Dynamic Function

Like the Auto function, the Dynamic function is also provided with independent parameters. To guard against sudden feedback, however, its settings are normally different from the Auto function. The step is larger, the response is set closer to "FAST," and the threshold is set higher to prevent operation from being triggered by an input signal (an ordinary signal other than feedback).

**[STEP]** (0.5 to 40.0 dB)

**MENU ▶ AFB mode ▶ AUTO/DYNA ▶**

**[RESPONSE]** (SLOW1 to FAST10)

**MENU ▶ AFB mode ▶ AUTO/DYNA ▶**

**[THRESHOLD]** (–60.0 to +20.0 dB)

**MENU ▶ AFB mode ▶ AUTO/DYNA ▶**

## Diffuse Function

This makes the settings for the Diffuse function. Because the frequency at which feedback occurs is normally determined by the distance between the mike and the sound reinforcement device, feedback can be eliminated by moving the microphone. The Diffuse function creates this effect electrically.

**[CYCLE]** (0.1 to 20.0 sec)

**MENU ▶ AFB mode ▶ DIFFUSE ▶**

This adjusts the cycle.

**[DISTANCE]** (0.01 to 14.0 m)

**MENU ▶ AFB mode ▶ DIFFUSE ▶**

This adjusts the distance.

## Mute Function

**[MUTE LEVEL]** (–∞ to 0.0 dB)

**MENU ▶ AFB mode ▶ MUTE ▶**

This sets the amount by which output will be attenuated when the Mute function is on.

## Editing in the PEQ Mode

### HPF and LPF Settings

The same procedure is used in each mode to make the settings for the HPF and LPF. See "HPF and LPF Settings (Common for All Modes)" (p. 20) for a description of this procedure.

### Initializing the PEQ Mode

This initializes the PEQ mode.

**[LINK]** (ON or OFF)

**MENU ▶ PEQ mode ▶ LINK ▶**

This makes the setting for linking the channels.

**ON:** The two channels operate in the same way.

**OFF:** The channels operate independently. Because all settings are independent, separate settings are made for each channel.

#### •When Link Is Switched from OFF to ON

This sets which channel -- left or right -- will serve as the basis for the settings that are applied commonly to both channels when Link is set to ON.

**L CH:** The settings for the left channel become the common settings for both channels.

**R CH:** The settings for the right channel become the common settings for both channels.

#### •Operation When Link Is Set to OFF

Because the channels act independently when Link is set to OFF, the following settings are possible.

#### Selecting the Displayed/Manipulated Channel

This selects the channel whose settings are shown and can be manipulated in the Analyzer/Filter screen.

**L CH:** Settings for the left channel are displayed/become manipulable.

**R CH:** Settings for the right channel are displayed/become manipulable.

To change the channel setting, move the cursor to the channel and press [ENTER]. This switches you to the setting screen for the channel.

---

### Filter Operation During a Quick Edit Session

The channel ("L" or "R") appears to the left of the filter number.

#### [RESOLUTION] (91BAND or 31BAND)

##### MENU ► PEQ mode ► ANALYZER ►

This chooses the number of bands for the spectrum analyzer.

**91BAND:** Functions as a 91-band spectrum analyzer.

**31BAND:** Functions as a 31-band spectrum analyzer.

## Editing in the GEQ Mode

### HPF and LPF Settings

The same procedure is used in each mode to make the settings for the HPF and LPF. See "HPF and LPF Settings (Common for All Modes)" for a description of this procedure.

### Initializing the GEQ Mode

This initializes the GEQ mode.

#### [TYPE] (91BAND or 31BAND)

##### MENU ► GEQ mode ► TYPE ►

This sets the type of graphic equalizer.

#### 91BAND

This makes the AP-700 function as a 91-band monaural graphic equalizer. When this type is selected, you can select Bypass or Mute for the channel that uses the equalizer and the channel that doesn't.

#### 31BAND

This makes the AP-700 function as a 31-band stereo graphic equalizer. When this type is selected, you can set Link to ON or OFF.

**ON:** The two channels operate in the same way.

**OFF:** The channels operate independently. Because all settings are independent, separate settings are made for each channel.

### •When Link Is Switched from OFF to ON

This selects which channel – left or right – will serve as the basis for the settings that are applied commonly to both channels when Link is set to ON.

**L CH:** The settings for the left channel become the common settings for both channels.

**R CH:** The settings for the right channel become the common settings for both channels.

### •Operation When Link Is Set to OFF

Because the channels act independently when Link is set to OFF, the following settings are possible.

#### Selecting the Displayed/Manipulated Channel

This selects the channel whose settings are shown and can be manipulated in the Analyzer/Filter screen.

**L CH:** Settings for the left channel are displayed/become manipulable.

**R CH:** Settings for the right channel are displayed/become manipulable.

To change the channel setting, move the cursor to the channel and press [ENTER]. This switches you to the setting screen for the channel.

### Filter Operation During a Quick Edit Session

The channel ("L" or "R") appears to the left of the filter number.

## Common Operations for All Modes

### HPF and LPF Settings (Common for All Modes)

This sets the parameters for the high-pass filter (HPF) and low-pass filter (LPF). The high-pass filter cuts frequency components lower than the setting, and the low-pass filter cuts frequency components higher than the setting.

#### MENU ► AFB mode(PEQ mode)(GEQ mode) ► HPF/LPF ►

#### <LPF>

#### [FREQUENCY] (500.0 Hz to 20.0 kHz)

This sets the cutoff frequency (the frequency at which the effect starts) for the low-pass filter.

#### [TYPE] (OFF, -6 dB/oct, or -12 dB/oct)

This sets the type of low-pass filter.

**OFF:** No LPF is used.

**-6 dB/oct:** This type cuts -6 dB per octave.

**-12 dB/oct:** This type cuts -12 dB per octave.

#### <HPF>

#### [FREQUENCY] (20.0 Hz to 2.0 kHz)

This sets the cutoff frequency (the frequency at which the effect starts) for the high-pass filter.

[TYPE] (OFF, -6 dB/oct, or -12 dB/oct)

This sets the type of high-pass filter.

OFF: No HPF is used.

-6 dB/oct: This type cuts -6 dB per octave.

-12 dB/oct: This type cuts -12 dB per octave.

### Zoom/Scroll for the Display (Common for All Modes)

This lets you set the range displayed when using Zoom or Scroll on the display.

GRPH ▶

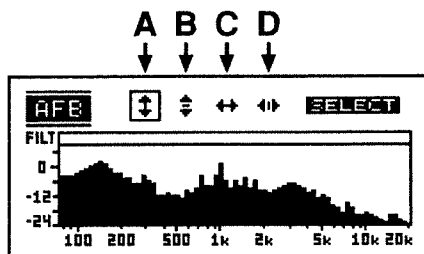

#### 1. Move the cursor to the function to be set.

- A: Scrolls (moves) through the displayed levels.
- B: Performs a zoom (magnification or reduction) on the displayed levels.
- C: Scrolls (moves) through the displayed frequencies.
- D: Performs a zoom (magnification or reduction) on the displayed frequencies.

#### 2. Use the (VALUE) buttons to set the display range.

## Editing System Parameters

### Audio I/O (Audio Input and Output)

The AP-700 can be input and output for analog and digital signals simultaneously. Here you can adjust the respective analog and digital input and output levels.

Information on digital I/O (input and output) is shown on the display.

#### <ANALOG>

[INPUT] ( $-\infty$  to 0.0 dB)

MENU ▶ SYSTEM ▶ AUDIO I/O ▶

This sets the input level for analog input.

\* When only digital input is used, set this to " $-\infty$ ."

[OUTPUT] ( $-\infty$  to 0.0 dB)

MENU ▶ SYSTEM ▶ AUDIO I/O ▶

This sets the output level for analog output.

#### <DIGITAL>

[INPUT] ( $-\infty$  to 0.0 dB: ON or OFF)

MENU ▶ SYSTEM ▶ AUDIO I/O ▶

This sets the input level for digital input. It also sets whether digital output is used (ON) or not used (OFF).

\* When only analog input is used, set this to "OFF."

[OUTPUT] ( $-\infty$  to 0.0 dB: ON or OFF)

MENU ▶ SYSTEM ▶ AUDIO I/O ▶

This sets the output level for digital output. It also sets whether digital input is used ("ON") or not used ("OFF").

---

## Delay

On the AP-700, each channel is provided with a delay for sound field compensation. These delays are common to all modes, and each delay has a maximum delay time of 411 msec (140 m). The delay time can be set as either a time or a distance value. Here's how to make the settings for this parameter.

**[L CH: Left Channel]** (0 cm to 140 m / 0 to 411 msec)

**MENU ► SYSTEM ► DELAY ►**

This sets the delay time for the left channel.

**[R CH: Right Channel]** (0 cm to 140 m / 0 to 411 msec)

**MENU ► SYSTEM ► DELAY ►**

This sets the delay time for the right channel.

## Displaying the Software Version

This displays the version number for the AP-700's software.

**MENU ► SYSTEM ► INFORMATION ►**

## Displaying Temporary Information

This displays what is currently in operation. Information on the following items is displayed.

**MENU ► SYSTEM ► INFORMATION ►**

### Original Patch Number

#### Patch Name

#### Whether edits have been performed

#### Comments

## Adjusting the Contrast of the Display

The display may occasionally become difficult to make out, depending on how and where the AP-700 is installed. If the display is hard to read, this parameter can be used to adjust the contrast (brightness).

**[CONTRAST]** (1 to 100)

**MENU ► SYSTEM ►**

This adjusts the contrast of the display.

## Initialize

This initializes the settings for the AP-700.

**MENU ► SYSTEM ► INITIALIZE ►**

### 1. Move the cursor to what you want to be initialized.

**ALL:** Initializes all settings. The settings return to the same values they had when shipped from the factory.

**SYSTEM:** Initializes the settings for system parameters.

**TEMP:** Initializes the settings for the mode that is currently in operation.

### 2. Use the (VALUE) buttons to select what you want to initialize.

### 3. Move the cursor to "EXEC" (execute) and press (ENTER). A message appears to confirm the initialization. Press (ENTER) to initialize the settings.

If you want to start over, move the cursor to (CANCEL) and press (ENTER).

---

## Memory Function

You can use the Memory function to attach names and comments to 16 types of settings, and save these as Patches. The contents of these Patches can then be called up and used whenever you need them. It's also possible to modify what you've called up and save it as a new Patch.

### Storing Settings (Save)

This stores the current settings in memory.

**MENU ► MEMORY ►**

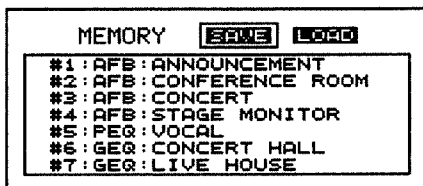

1. Move the cursor to "SAVE" and press (ENTER).
2. Use the cursor buttons to move the cursor to the Patch number to serve as the destination for saving, and press (ENTER).
3. The display changes to the Patch Name settings screen. Move the cursor to the text input area and use the (VALUE) buttons to change the characters.  
  
Repeat step 3 until you've finished inputting the Patch Name and comment.
4. Press (ENTER).
5. Press (ENTER) to save the Patch.

If you want to start over, move the cursor to (CANCEL) and press (ENTER).

### Calling Up a Patch (Load)

This calls up a Patch stored in memory.

**MENU ► MEMORY ►**

1. Move the cursor to "LOAD" and press (ENTER).
2. Use the cursor buttons to move the cursor to the patch number to choose the patch you want to call up, and press (ENTER).

The Patch Name and comment stored with the Patch you've selected appear on the display.

3. Press (ENTER) to load the Patch.

If you want to select over, move the cursor to (CANCEL) and press (ENTER).

## Section 6: How to Use MIDI

This section describes the MIDI functions of the AP-700. The settings you make will vary depending on the desired use.

### What Can You Do With MIDI?

With the AP-700, you can use MIDI to perform the following operations.

#### • Switching Program Numbers

The unit can be set so the Patch on the AP-700 changes at the same time when a tone change (Program Change message) is received from the external MIDI device.

The correspondences between Program Change numbers and the AP-700's Patches can be changed by altering the Program Change Map.

#### • Data Transmission

Exclusive (SysEx) messages can be used to send settings stored in the AP-700 to another MIDI device. This makes it possible to re-create identical settings on another AP-700, or send the settings to a sequencer for storage.

#### • MIDI messages passing through

MIDI messages input from the MIDI IN connector are output from the MIDI OUT connector.

#### • MIDI Indicator

The AP-700 comes with a MIDI indicator. The MIDI indicator lights up only while receiving MIDI information from another MIDI device.

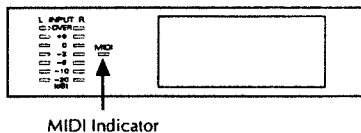

### Settings for MIDI Functions

This performs operations for MIDI functions on the AP-700.

\* If you require more details about MIDI on the AP-700, a separate "MIDI Implementation" is available for purchase. Contact your nearest Roland Service Station.

[OMNI: Omni Mode] (ON or OFF)

MENU ► MIDI ► PROPERTY ►

When the Omni mode is set to ON, the information on all MIDI channels is received, regardless of the actual MIDI channel setting.

\* Even when the Omni mode is set to ON, SysEx messages are received only when the data is on the MIDI channel (device ID) set with the "MIDI Channel" parameter.

[CHANNEL: MIDI Channel] (1 to 16)

MENU ► MIDI ► PROPERTY ►

This sets the MIDI channel. The AP-700 sends and receives MIDI information on the MIDI channel that is set here.

[DEVICE ID] (1 to 127)

MENU ► MIDI ► PROPERTY ►

This sets the Device ID Number in order to handle System Exclusive message when transmitting or receiving data settings via MIDI.

### Settings for the Program Change Map

The AP-700 can change Patches according to Program Change messages sent from an external MIDI instrument, and this parameter lets you set the relationship between the received Program Change number and the Patch number that changes however you like.

MENU ► MIDI ► PC MAP ►

1. Use the cursor buttons to move the cursor to Program Change number to be received.
2. Use the (VALUE) buttons to select the AP-700 Patch number to correspond to the received Program Change number.

Repeat steps 1 and 2 to set the corresponding Patch number for each of the Program Change numbers.



## Settings for the Control Change Map

You can control the functions in the AFB mode with Control Change messages sent from the external MIDI device. The function is switched on when the value of the received Controller number is higher than the median value (64 to 127) and switched off when it is lower (0 to 63).

The relationship between the Controller number that the AP-700 receives and the function that is switched can be changed however you like.

### MENU ► MIDI ► CC MAP ►

#### 1. Use the cursor buttons to select the function in the AFB mode that you want to set.

- AUTO:** Sets the Controller number for switching the Auto function on and off.
- CLR:** Sets the Controller number for clearing filters set by the Auto function.
- DYNAMIC:** Sets the Controller number for switching the Dynamic function on and off.
- MANUAL:** Sets the Controller number for switching the Manual function on and off.
- DIFFUSE:** Sets the Controller number for switching the Diffuse function on and off.
- MUTE:** Sets the Controller number for switching the Mute function on and off.
- LOCK:** Sets the Controller number for switching the Lock on and off.
- BYPASS:** Sets the Controller number for switching Bypass on and off.

#### 2. Use the (VALUE) buttons to set the Controller number (0 to 31 or 64 to 95) to correspond to the function.

Repeat steps 1 and 2 to set the corresponding Controller number for each of the functions.

## Sending Data (Bulk Dump)

With the AP-700, you can use SysEx messages to re-create identical settings on another AP-700, or send data to sequencer to be saved. This transmission of SysEx messages is called a "bulk dump." You can specify the data you want to send so that only that data is sent.

### <How to Make the Connections>

#### Saving Data on a Sequencer

Hook up the two devices as shown below, and get the sequencer ready for receiving SysEx messages.

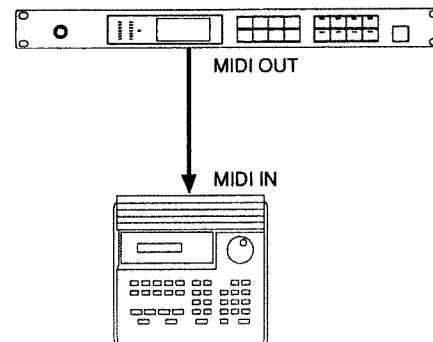

\* Refer to the sequencer's manual if you need instructions on how to operate the sequencer.

#### Copying Data to Another AP-700

Hook up the two devices as shown below, and make sure the sending unit and the receiving unit are set to the same MIDI channel.

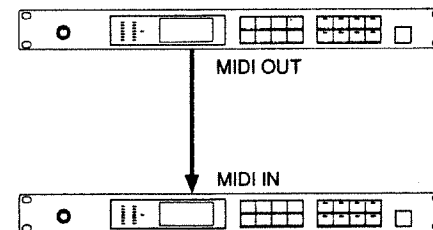

### <How to Send the Data>

#### MENU ► MIDI ► BULK DUMP ►

#### 1. Moving the cursor, select the type of data you want to send.

- ALL:** Sends all settings.
- SYSTEM:** Sends the settings for the system parameters.
- TEMP:** Sends the settings for the current state of operation.
- MEMORY ALL:** Sends the contents of all the Patches.
- #1 to #16:** Sends the settings for the corresponding Patch.

#### 2. Use the (VALUE) buttons to select what is to be sent.

#### 3. Move the cursor to "EXEC" and press (ENTER) to send the data.

---

## Receiving Data (Bulk Load)

You can receive data from another AP-700, or receive AP-700 data previously stored on a sequencer. Such data reception is called a "bulk load."

### <How to Make the Connections>

#### Receiving Data Stored on a Sequencer

Connect the two devices as shown below. Set the AP-700 to the same MIDI channel that was used when the data was saved on the sequencer.

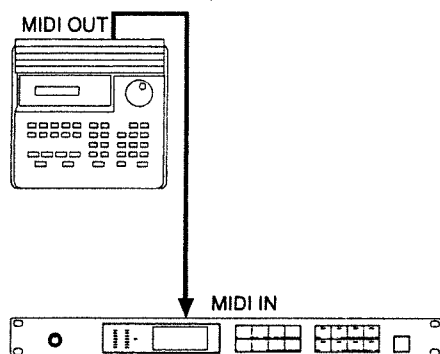

\* Refer to the sequencer's manual if you need instructions on how to operate the sequencer.

### <How to Receive the Data>

The AP-700 can receive SysEx messages from an external MIDI device at any time.

The following message appears on the display while receiving bulk data.

**DATA RECEIVING**

## Section 7: Supplementary Materials

### If You Think There May Be a Problem, Check Here First

If no sound is produced, or if you think operation may be strange, then first check the points described here. If this doesn't clear up the problem, then go ahead and contact the store where you purchased the AP-700 or your nearest Roland Service Station.

#### There's No Sound or Sound Is Too Low

- Is the other equipment connected correctly?
- Is the connected amp or mixer turned on, and is the volume turned up high enough?
- Is the INPUT LEVEL knob turned up high enough?
- Is the Mute function switched off?
- Could there be broken elements inside the connection cables?

Try replacing the connection cables.

#### Sound Is Distorted (The "OVER" Reading on the Level Meter Lights Up)

- Is the INPUT LEVEL knob at an appropriate setting (p. 8)?
- Could the output level of the external equipment be too high?
- Is the sound still distorted when you change Patches? If the distortion disappears when the Patch is changed, check the settings for the first Patch.

#### Patches Don't Change As Expected

- Are the two devices set to the same MIDI channel? If the Patch changes to the wrong one, check the settings for the Program Change Map (p. 24).

### List of Display Messages

Shown below are the messages that may be displayed during operation of the AP-700.

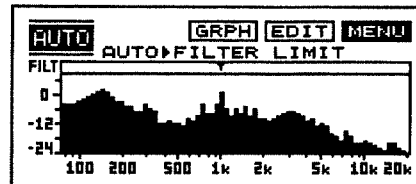

The Auto function requested a setting that is beyond the capacity of the filter (compensation over  $-40$  dB is required).

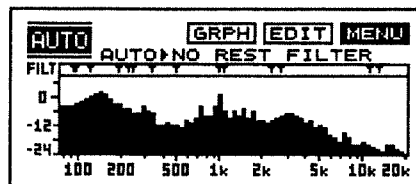

A request was made for more filters than the reserved number.

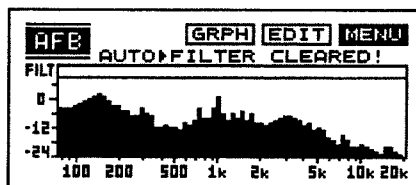

The [CLEAR] button was used to clear the filters of the Auto function.

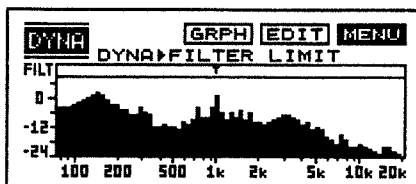

The Dynamic function requested a setting that is beyond the capacity of the filter (compensation over  $-40$  dB is required).

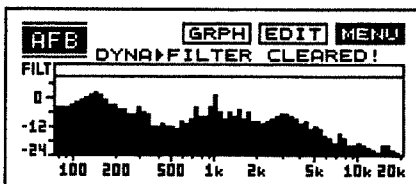

A Dynamic Off was issued, clearing the filters of the Dynamic function.

---

## About Digital Input and Output

The AP-700 uses the following types of digital audio signals in AES/EBU format.

- **Professional Use**
- **Audio Signal**
- **Emphasis Rating:** 50  $\mu$ sec/15  $\mu$ sec
- **Sampling Frequency:** 44.1 kHz/48 kHz
- **2-Channel Mode**

### <Digital Input>

Format: AES/EBU Professional Use  
Connector: XLR-3-31 type  
Electrical characteristics: RS-422A  
Impedance: 250  $\Omega$  balanced  
Transfer rate: 3.072 Mbit/sec, fs = 48 kHz

### <Digital Output>

Format: AES/EBU Professional Use  
Connector: XLR-3-32 type  
Electrical characteristics: RS-422A  
Impedance: 110  $\Omega$  balanced  
Transfer rate: 3.072 Mbit/sec, fs = 48 kHz

## About Channel Status

The channel status for the AP-700 is set as follows.

### When Using Digital Input

Digital output is made while maintaining the channel status for digital input.

### When Not Using Digital Input

Digital output is made with the following settings

- **Professional Use**
- **Audio Signal**
- **Emphasis: Off**
- **Sampling Frequency: 48 kHz**

### Important Points When Using Digital Input

When using digital input, momentary muting or noise may occur in the following cases in order to ensure synchronization of internal processing and the external input.

- **When connecting or disconnecting connectors**
- **When the sampling frequency changes**
- **When an error occurs**

# Equalizer Characteristics

---

<AFB mode>

**AUTO / DYNAMIC / MANUAL**

FILTER TYPE: PEAKING

FREQUENCY(Hz): 630 to 1080

Q: 15.0 (AUTOMATICALLY)

LEVEL(dB): -10

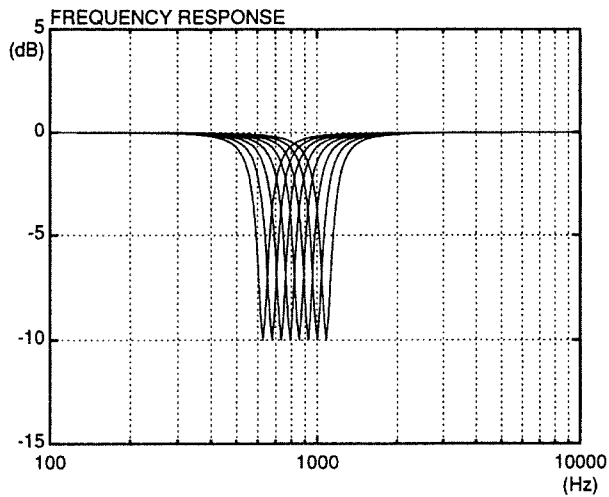

<AFB mode>

**AUTO / DYNAMIC**

FILTER TYPE: PEAKING

FREQUENCY(Hz): 1000

Q: AUTOMATICALLY

LEVEL(dB): -5 to -40

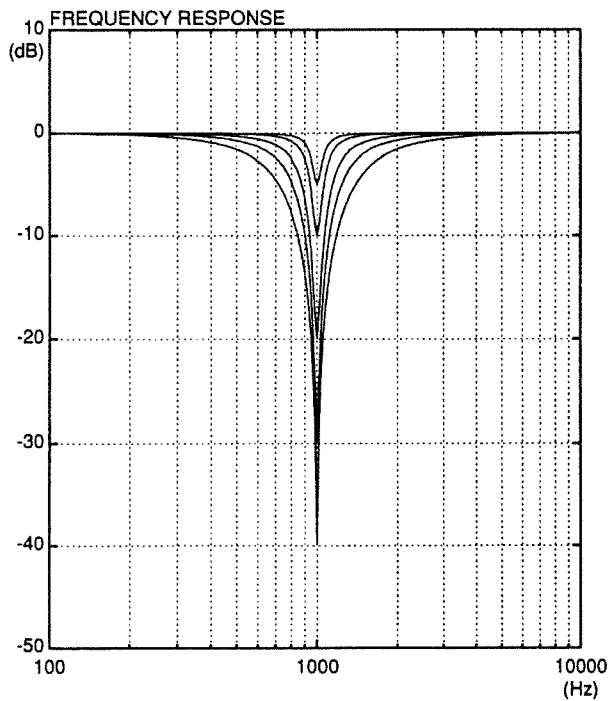

---

**<AFB mode>**

**MANUAL**

FILTER TYPE: PEAKING  
Q: 25 to 100

FREQUENCY(Hz): 1000  
LEVEL(dB): -20

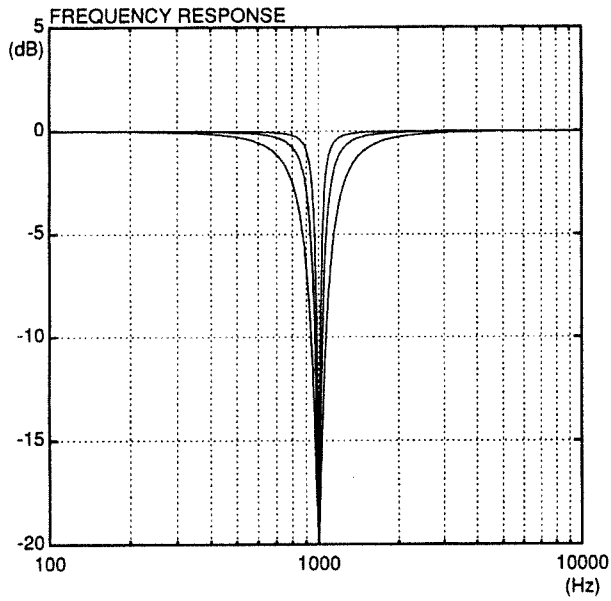

**<AFB mode / PEQ mode>**

FILTER TYPE: LOW SHELVING / HIGH SHELVING  
FREQUENCY(Hz): 25 to 250 / 1600 to 16000

LEVEL(dB): -10 / +10

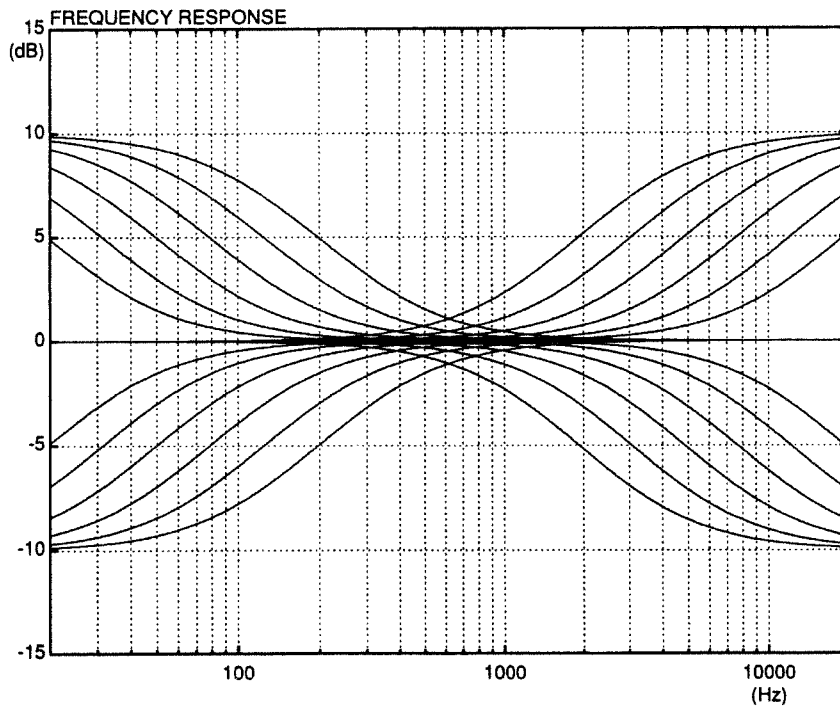

---

**<AFB mode: MANUAL / PEQ mode>**

FILTER TYPE: LOW SHELVING / HIGH SHELVING

FREQUENCY(Hz): 250 / 2000

LEVEL(dB):  $\pm 3$  to  $\pm 12$

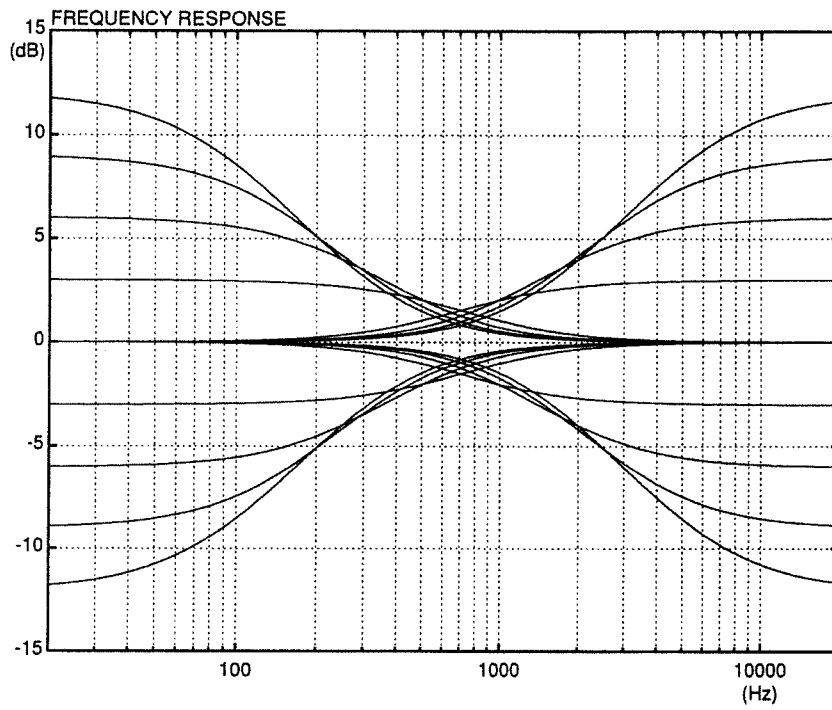

**<PEQ mode>**

FILTER TYPE: PEAKING

FREQUENCY(Hz): 100 to 6300

Q: 20

LEVEL(dB): -12 / +12

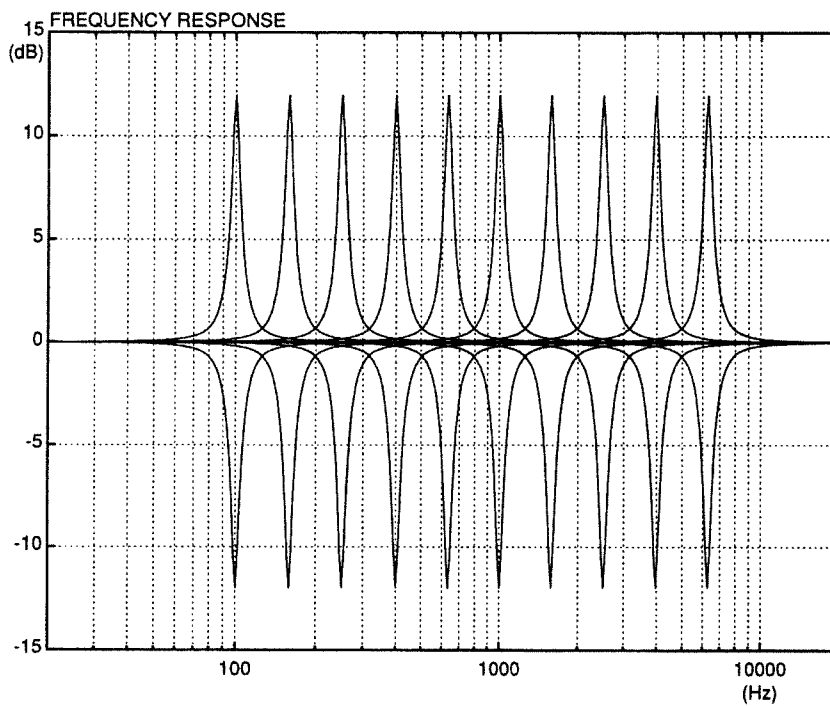

---

**<PEQ mode>**

FILTER TYPE: PEAKING      FREQUENCY(Hz): 1000  
Q : 0.3 to 100      LEVEL(dB): -12 / +12

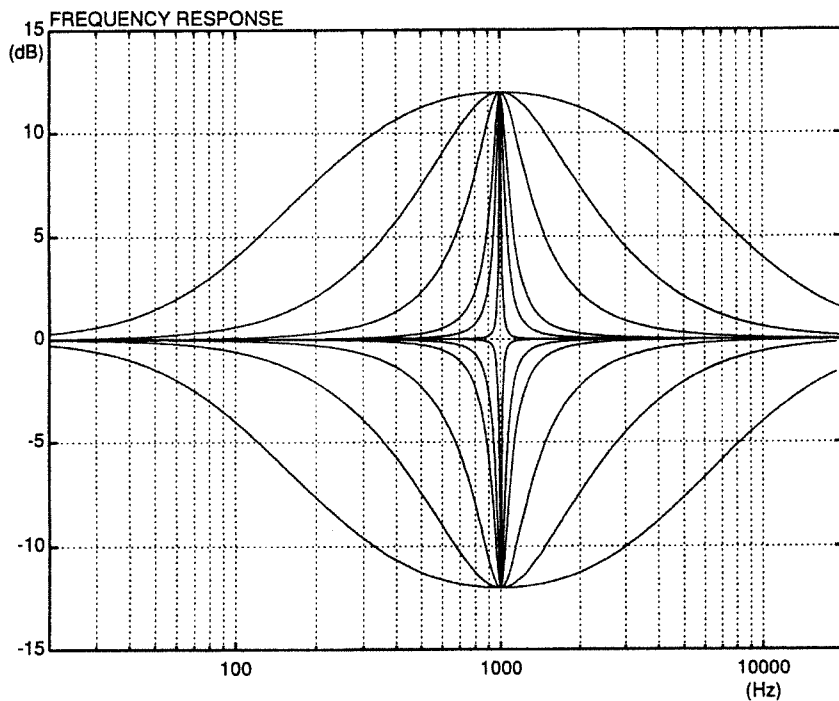

**<PEQ mode>**

FILTER TYPE: PEAKING      FREQUENCY(Hz): 1000  
Q : 2      LEVEL(dB): -12 to +12

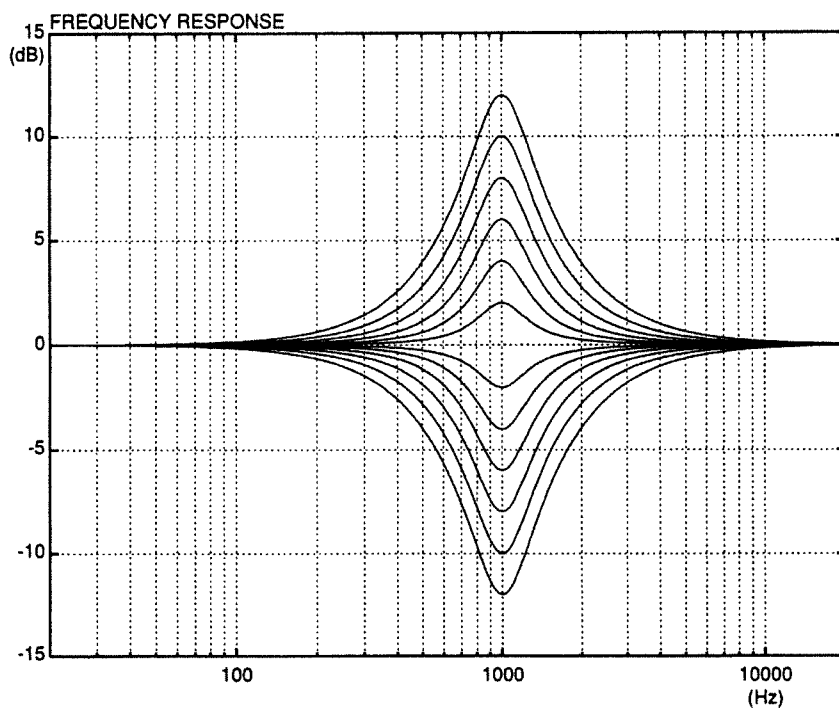



---

<GEQ mode>

**31 Band EQUALIZER**

LEVEL(dB): -12 / +12

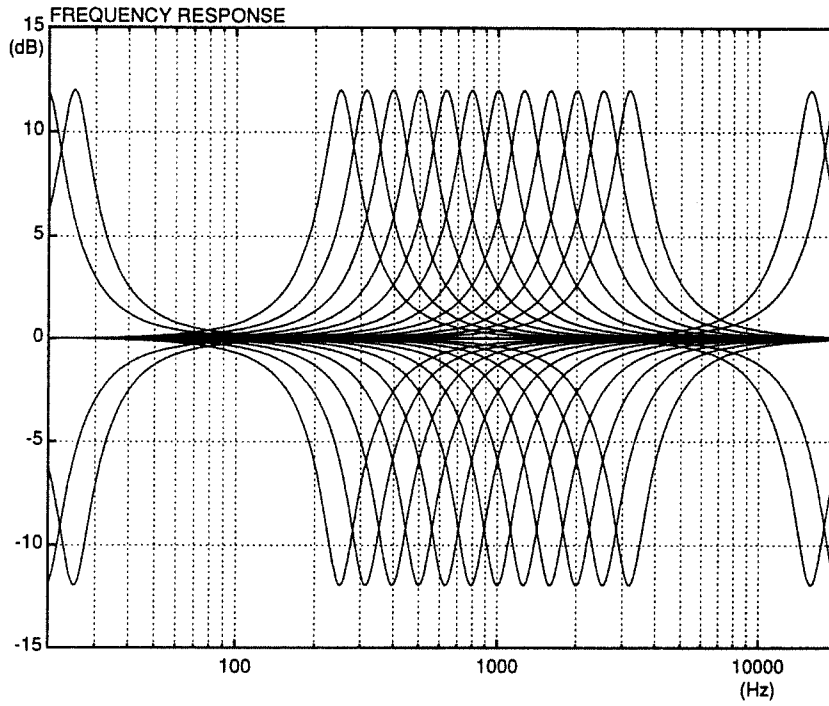

<GEQ mode>

**91 Band EQUALIZER**

LEVEL(dB): -12 / +12

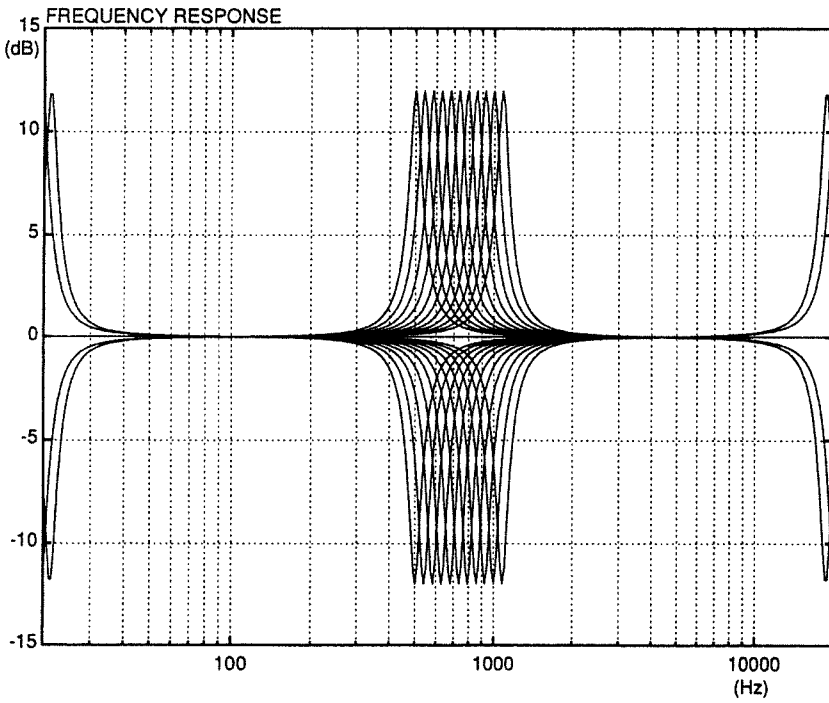

---

**<AFB mode / PEQ mode / GEQ mode>**

FILTER TYPE: HPF / LPF      FREQUENCY(Hz): 25 to 200 / 2500 to 16000

TYPE: -12 dB/oct

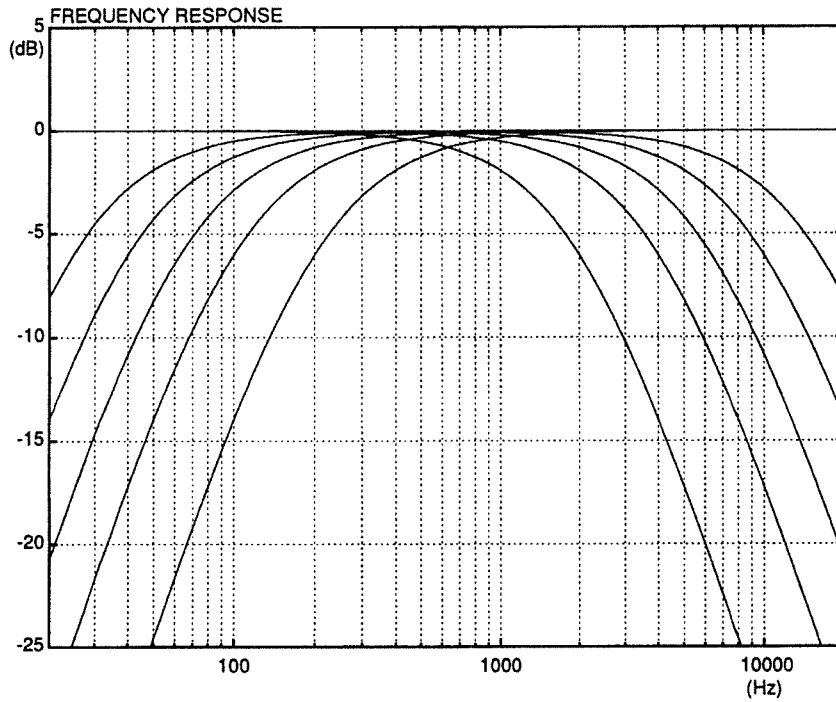

**<AFB mode / PEQ mode / GEQ mode>**

FILTER TYPE: HPF / LPF      FREQUENCY(Hz): 25 to 200 / 2500 to 16000

TYPE: -6 dB/oct

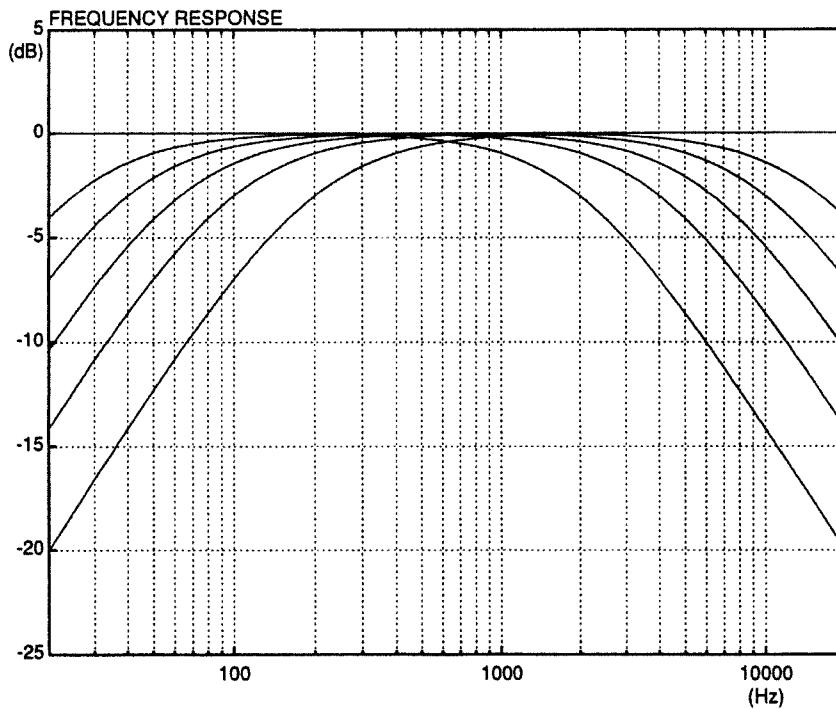

# Parameter Table

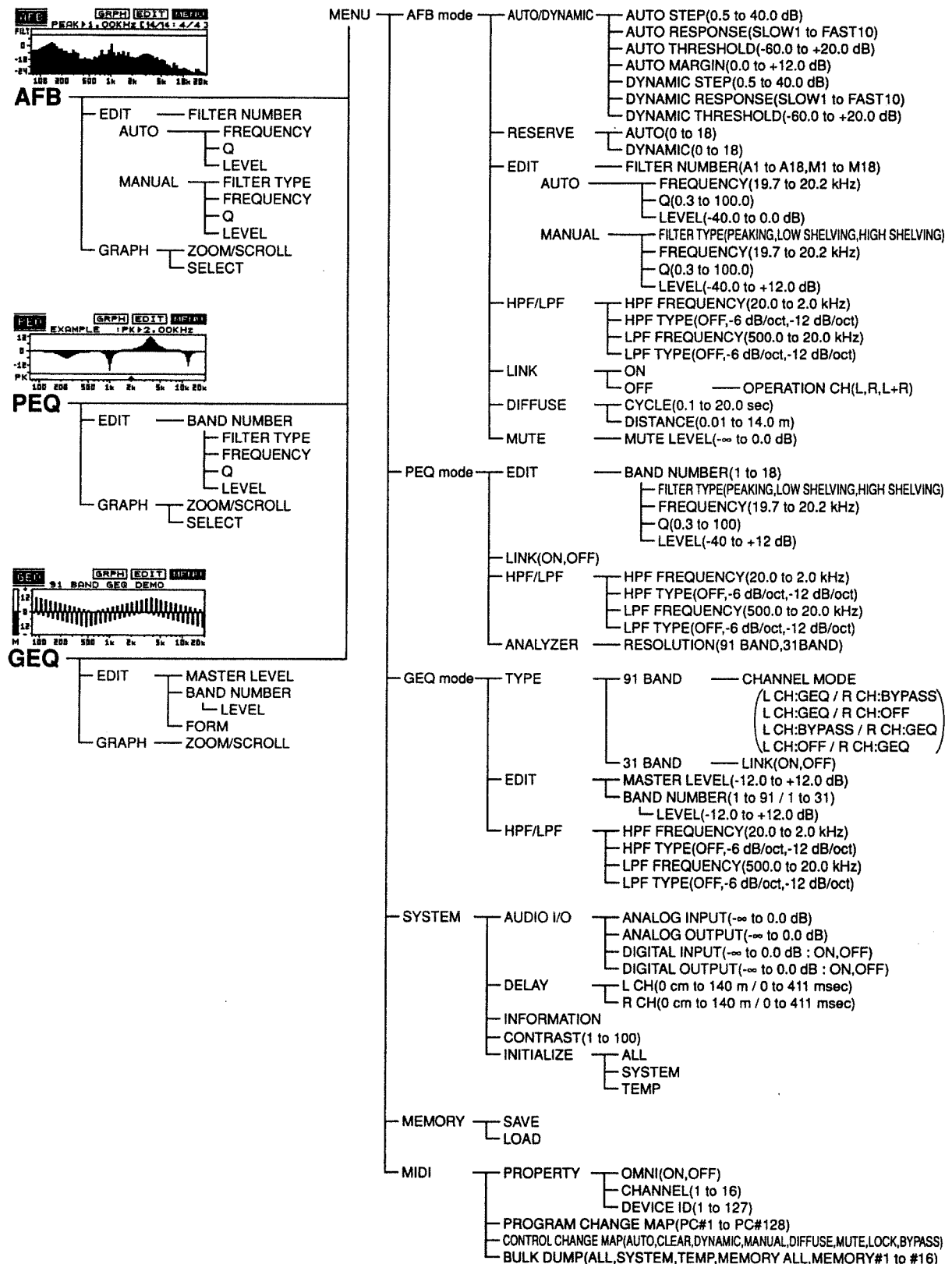

# MIDI Implementation Chart

Function...	Transmitted	Recognized	Remarks
Basic Channel Default Changed	1 — 16 1 — 16	1 — 16 1 — 16	Memorized
Mode Default Messages Altered	X X *****	OMNI ON/OFF X X	Memorized
Note Number : True Voice	X *****	X X	
Velocity Note ON Note OFF	X X	X X	
After Touch Key's Ch's	X X	X X	
Pitch Bend	X	X	
Control Change 0 — 31	X	O *1	*2
Control Change 64 — 95	X	O *1	*2
Prog Change : True #	X *****	O *1 0 — 127	
System Exclusive	O	O	
System Common : Song Pos : Song Sel : Tune	X X X	X X X	
System Real Time : Clock : Commands	X X	X X	
Aux Message : Local ON/OFF : All Notes OFF : Active Sense : Reset	X X X X	X X X X	
Notes	* 1 Can be set manually to O/X, and permanently memorized. * 2 Made controllable by specifying one particular parameter. MIDI messages input from the MIDI IN connector are output from the MIDI OUT connector. For detained information on MIDI data of the AP-700, a separate "MIDI Implementation document" is available at any Roland Service Station.		

Mode 1 : OMNI ON, POLY  
 Mode 3 : OMNI OFF, POLY

Mode 2 : OMNI ON, MONO  
 Mode 4 : OMNI OFF, MONO

O : Yes  
 X : No

---

## Main Specifications

### AP-700: ADVANCED EQUALIZING PROCESSOR

#### • A/D Conversion

20 bit 64 times oversampling  $\Delta\Sigma$  Conversion

#### • D/A Conversion

20 bit 8 times oversampling

#### • Sampling Frequency

44.1 / 48 kHz

#### • Program Memory

16

#### • Frequency Response

8 to 22.5 kHz (+0 / -3 dB) at 48 kHz Sampling

#### • Nominal Input Level

+4 dBm (Balanced)

#### • Input Impedance

30 k $\Omega$ : 2pin(COLD) – 3pin(HOT)

10 k $\Omega$ : 1pin(GND) – 3pin(HOT)/1pin(GND) – 2pin(COLD)

#### • Head Room

20 dB

#### • Nominal Output Level

+4 dBm (Balanced) into 600  $\Omega$

#### • Output Impedance

350  $\Omega$ : 2pin(COLD) – 3pin(HOT)

100  $\Omega$ : 1pin(GND) – 3pin(HOT)/1pin(GND) – 2pin(COLD)

#### • Maximum Output Level

24 dBm into 600  $\Omega$

#### • Total Harmonic Distortion

0.02 % or Less at 1 kHz; +4 dBm into 600  $\Omega$

#### • Dynamic Range

105 dB or greater (IHF-A)

#### • Controls

INPUT LEVEL Knobs (L, R)

Cursor Buttons (Up, Down, Right, Left)

Value Buttons (Up, Down)

ENTER Button

EXIT Button

AUTO Button

DYNAMIC Button

MANUAL Button

CLEAR Button

DIFFUSE Button

MUTE Button

BYPASS Button

LOCK Button

POWER Switch

#### • Display

160 x 64 (backlit Graphic LCD)

#### • Indicators

INPUT Level Indicator (7 points Stereo)

MIDI Indicator

#### • Connectors

INPUT Jacks (L, R) XLR, PHONE

OUTPUT Jacks (L, R) XLR, PHONE

DIGITAL I/O Connectors (IN, OUT) (XLR; AES/EBU)

MIDI Connectors (IN, OUT)

#### • Power Supply

AC117 V, AC230 V or AC240 V

#### • Power Consumption

27 W

#### • Dimensions

482 (W) x 359 (D) x 44 (H) mm

19 (W) x 14-3/16 (D) x 1-3/4 (H) inches

(EIA-1U rack mount type)

#### • Weight

4.5 kg / 9 lbs 15oz

#### • Accessories

Owner's Manual

\* 0 dBm = 0.775 Vrms

\* The specifications for this product are subject to change without prior notice.

# Index

1/4 inch phone jack .....	7	Level(AFB) .....	17
About Digital Input and Output .....	28	Level(GEQ) .....	16
AFB(Anti-Feedback) Mode .....	5, 11	Level(PEQ) .....	15
Analog .....	21	Level Settings for Each Band(Frequency) .....	16
Analyzer/Filter Screen .....	10	Link(AFB) .....	18
Analyzer/Filter Screen(AFB) .....	11	Link(PEQ) .....	19
Analyzer/Filter Screen(PEQ) .....	14	List of Display Messages .....	27
Audio I/O .....	21	Lock .....	9
Auto Function .....	11, 12, 18	Low-Pass Filter(LPF) .....	11
Band Number(PEQ) .....	14	Making the Connections .....	7
Bypass .....	9	Manual .....	11, 13
Calling Up a Patch(Load) .....	23	Margin .....	19
Choosing Parameters .....	9	Master Level .....	16
Choosing the Mode .....	10	MIDI Channel .....	24
Clear .....	12	MIDI Implementation Chart .....	36
Contrast .....	22	Mute .....	11, 13, 19
Control Change Map .....	25	Number of Reserved Filters .....	18
Cursor Button .....	9	Omni Mode .....	24
Cycle .....	19	Output .....	21
Delay .....	22	Parameter Table .....	35
Device ID .....	24	PEQ(Parametric Equalizer) Mode .....	5, 14
Diffuse Function .....	11, 12, 19	Program Change Map .....	24
Digital .....	21	Q(AFB) .....	17
Distance .....	19	Q(PEQ) .....	14
Dynamic Function .....	11, 12, 19	Quick Edit .....	17
Editing .....	17	Rear Panel .....	6
Enter Button .....	9	Receiving Data(Bulk Load) .....	26
Equalizer Characteristics .....	29	Resolution .....	20
Filter Number .....	17	Response .....	18, 19
Filter Screen(GEQ) .....	16	Sending Data(Bulk Dump) .....	25
Filter Type(AFB) .....	17	Setting the Level Curve Automatically .....	16
Filter Type(PEQ) .....	14	Software Version .....	22
Frequency(AFB) .....	17	Specifications .....	37
Frequency(HPF, LPF) .....	20	Spectrum Analyzer .....	11
Frequency(PEQ) .....	14	Step .....	18, 19
Front Panel .....	6	Storing Settings(Save) .....	23
GEQ(Graphic Equalizer) Mode .....	5, 16	Switching On the Power .....	8
High-Pass Filter(HPF) .....	11	Temporary Information .....	22
HPF and LPF Settings .....	20	Threshold .....	18, 19
Initialize .....	22	Type(GEQ) .....	20
Initializing the AFB Mode .....	18	Type(HPF, LPF) .....	20
Initializing the GEQ Mode .....	20	XLR Connector .....	7
Initializing the PEQ Mode .....	19	Zoom/Scroll .....	21
Input .....	21		
Input Level .....	8		

For Nordic Countries

## Apparatus containing Lithium batteries

### ADVARSEL!

Lithiumbatteri - Eksplosjonsfare ved feilagtig håndtering.  
Udskiftning må kun ske med batteri af samme fabrikat og type.  
Lévér det brugte batteri tilbage til leverandøren.

### VARNING!

Explosionsfara vid felaktigt batteribyte.  
Använd samma batterityp eller en ekvivalent typ som rekommenderas av apparattillverkaren.  
Kassera använt batteri enligt fabrikantens instruktion.

### ADVARSEL!

Lithiumbatteri - Eksplosjonsfare.  
Ved utskifting benyttes kun batteri som anbefalt av apparatfabrikanten.  
Brukt batteri returneres apparatleverandøren.

### VAROITUS!

Paristo voi räjähtää, jos se on virheellisesti asennettu.  
Vaihda paristo ainoastaan laitevalmistajan suosittelemaan tyyppiin. Hävitä käytetty paristo valmistajan ohjeiden mukaisesti.

For Germany

## Bescheinigung des Herstellers/Importeurs

Hiermit wird bescheinigt, daß der/die/das

Advanced Equalizing Processor AP-700

(Gerät, Typ, Bezeichnung)

in Übereinstimmung mit den Bestimmungen der BMPT-AmtsblVfg 243/1991, 46/1992 funk-entstört ist.  
Der vorschriftsmäßige Betrieb mancher Geräte (z. B. Meßsender) kann allerdings gewissen Einschränkungen unterliegen. Beachten Sie deshalb die Hinweise in der Bedienungsanleitung.

Dem Zentralamt für Zulassungen im Fernmeldewesen wurde das Inverkehrbringen dieses Gerätes angezeigt und die Berechtigung zur Überprüfung der Serie auf die Einhaltung der Bestimmungen eingeräumt.

Roland Corporation

4-16 Dojimahama 1-Chome Kita-ku Osaka 530 Japan

(Name und Anschrift des Herstellers/Importeurs)

For the USA

## FEDERAL COMMUNICATIONS COMMISSION RADIO FREQUENCY INTERFERENCE STATEMENT

This equipment has been tested and found to comply with the limits for a Class B digital device, pursuant to Part 15 of the FCC Rules. These limits are designed to provide reasonable protection against harmful interference in a residential installation. This equipment generates, uses, and can radiate radio frequency energy and, if not installed and used in accordance with the instructions, may cause harmful interference to radio communications. However, there is no guarantee that interference will not occur in a particular installation. If this equipment does cause harmful interference to radio or television reception, which can be determined by turning the equipment off and on, the user is encouraged to try to correct the interference by one or more of the following measures:

- Reorient or relocate the receiving antenna.
- Increase the separation between the equipment and receiver.
- Connect the equipment into an outlet on a circuit different from that to which the receiver is connected.
- Consult the dealer or an experienced radio/TV technician for help.

Unauthorized changes or modification to this system can void the users authority to operate this equipment.  
This equipment requires shielded interface cables in order to meet FCC class B Limit.

For Canada

### CLASS B

### NOTICE

This digital apparatus does not exceed the Class B limits for radio noise emissions set out in the Radio Interference Regulations of the Canadian Department of Communications.

### CLASSE B

### AVIS

Cet appareil numérique ne dépasse pas les limites de la classe B au niveau des émissions de bruits radioélectriques fixés dans le Règlement des signaux parasites par le ministère canadien des Communications.

## Information

When you need repair service, call your local Roland Service Station or the authorized Roland distributor in your country as shown below.

### U. S. A.

**Roland Corporation U.S.**  
7200 Dominion Circle  
Los Angeles, CA. 90040-  
3696, U. S. A.  
TEL: (213) 685 5141

### CANADA

**Roland Canada Music Ltd.**  
**(Head Office)**  
5480 Parkwood Way  
Richmond B. C., V6V 2M4  
CANADA  
TEL: (604) 270 6626

### Roland Canada Music Ltd.

**(Montreal Office)**  
9425 Transcanadienne  
Service Rd. N., St Laurent,  
Quebec H4S 1V3, CANADA  
TEL: (514) 335 2009

### Roland Canada Music Ltd.

**(Toronto Office)**  
346 Watline Avenue,  
Mississauga, Ontario L4Z  
1X2, CANADA  
TEL: (416) 890 6488

### AUSTRALIA

**Roland Corporation**  
**Australia Pty. Ltd.**  
38 Campbell Avenue  
Dee Why West, NSW 2099  
AUSTRALIA  
TEL: (02) 982 8266

### NEW ZEALAND

**Roland Corporation**  
**(NZ) Ltd.**  
97 Mt. Eden Road, Mt. Eden,  
Auckland 3, NEW  
ZEALAND  
TEL: (09) 3098 715

### UNITED KINGDOM

**Roland (U.K.) Ltd.**  
Rye Close Ancells Business  
Park Fleet, Hampshire GU13  
8UY, UNITED KINGDOM  
TEL: (0252) 816181

### Roland (U.K.) Ltd.,

**Swansea Office**  
Atlantic Close, Swansea  
Enterprise Park, Swansea,  
West Glamorgan SA79FJ,  
UNITED KINGDOM  
TEL: (0792) 700 139

### IRELAND

**The Dublin Service**  
**Centre Audio**  
**Maintenance Limited**  
11 Brunswick Place Dublin 2  
Republic of Ireland  
TEL: (01) 677322

### ITALY

**Roland Italy S. p. A.**  
Viale delle Industrie 8 20020  
ARESE MILANO ITALY  
TEL: (02) 93581311

### SPAIN

**Roland Electronics**  
**de España, S. A.**  
Calle Bolivia 239 08020  
Barcelona, SPAIN  
TEL: (93) 308 1000

### GERMANY

**Roland Elektronische**  
**Musikinstrumente**  
**Handelsgesellschaft mbH.**  
Oststrasse 96, 22844  
Norderstedt, GERMANY  
TEL: (040) 52 60090

### FRANCE

**Guillard Musiques Roland**  
ZAC de Rosange Les Echets  
01700  
MIRIBEL FRANCE  
TEL: (72) 26 5060

### Guillard Musiques Roland

**(Paris Office)**  
1923 rue Leon Geoffroy  
94400 VITRY - SUR - SEINE  
FRANCE  
TEL: (1) 4680 86 62

### BELGIUM/HOLLAND/ LUXEMBOURG

**Roland Benelux N. V.**  
Houtstraat 1 B-2260 Oevel-  
Westerlo BELGIUM  
TEL: (014) 575811

### DENMARK

**Roland Scandinavia A/S**  
Langebrogade 6 Box 1937  
DK-1023 Copenhagen K.  
DENMARK  
TEL: 31 95 31 11

### SWEDEN

**Roland Scandinavia A/S**  
Danvik Center 28 A, 2 tr.  
S-131 30 Nacka SWEDEN  
TEL: (08) 702 0020

### NORWAY

**Roland Scandinavia**  
**Avd. Kontor Norge**  
Lilleakerveien 2 Postboks 95  
Lilleaker N-0216 Oslo 2  
NORWAY  
TEL: (02) 73 0074

### FINLAND

**Fazer Musik Inc.**  
Länsituulentie POB 169,  
SF-02101 Espoo FINLAND  
TEL: (00) 43 5011

### SWITZERLAND

**Roland (Switzerland) AG**  
**Musitronic AG**  
Gerberstrasse 5, CH-4410  
Liestal, SWITZERLAND  
TEL: (061) 921 1615

### AUSTRIA

**E. Dematte & Co.**  
Neu-Rum Siemens-Strasse 4  
A-6040 Innsbruck P.O.Box  
83  
AUSTRIA  
TEL: (0512) 26 44 260

### GREECE

**V. Dimitriadis & Co. Ltd.**  
20, Alexandras St. &  
Bouboulinas 54 St. 106 82  
Athens, GREECE  
TEL: (01) 8232415

### PORTUGAL

**Caius - Tecnologias**  
**Audio e Musica , Lda.**  
Rue de Catarina 131  
4000 Porto, PORTUGAL  
TEL: (02) 38 4456

### HUNGARY

**Intermusica Ltd.**  
Warehouse Area 'DEPOY'  
Pl.83 H-2046 Torokbalint,  
Budapest HUNGARY  
TEL: (1) 1868905

### ISRAEL

**D.J.A. International Ltd.**  
Twin Towers, 33 Jabntinsky St.  
Room 211, Ramat Gan 52511  
ISRAEL  
TEL: (03) 751 8585

### CYPRUS

**Radex Sound**  
**Equipment Ltd.**  
17 Diagorou St., P.O.Box  
2046, Nicosia CYPRUS  
TEL: (2) 453 426  
(2) 466 423

### U.A.E

**Zak Electronics &**  
**Musical Instruments Co.**  
P.O. Box 8050  
DUBAI, U.A.E  
TEL: 360715

### KUWAIT

**Easa Husain Al-Yousifi**  
P.O. Box 126 Safat 13002  
KUWAIT  
TEL: 5719499

### LEBANON

**A. Chahine & Fils**  
P.O. Box 16-5857  
Beirut, LEBANON  
TEL: (01) 335799

### TURKEY

**Barkat Sanayi ve Ticaret**  
Siraselviler Cad. 86/6  
Taksim Istanbul, TURKEY  
TEL: (0212) 2499324

### EGYPT

**Al Fanny Trading Office**  
9, Ebn Hagar Ai Askalany  
Street, Ard El Golf,  
Heliopolis, Cairo, 11341  
EGYPT  
TEL: (02) 4171828  
(02) 4185531

### QATAR

**Badie Studio & Stores**  
P.O.Box 62,  
DOHA Qatar  
TEL: 423554

### SYRIA

**Technical Light &**  
**Sound Center**  
Khaled Ebn Al Walid St.  
P.O.Box 13520  
Damascus - Syria  
TEL: (11) 2235 384

### BAHRAIN

**Moon Stores**  
Bad Al Bahrain Road,  
P.O.Box 20077  
State of Bahrain  
TEL: 211 005

### REUNION

**FO - YAM Marcel**  
25 Rue Jules MermetZL  
Chaudron - BP79 97491  
Ste Clotilde REUNION  
TEL: 262 28 29 16

### BRAZIL

**Roland Brasil Ltda.**  
R. Coronel Octaviano da  
Silveira 203 05522-010  
Sao Paulo BRAZIL  
TEL: (11) 843 9377

### MEXICO

**Casa Veerkamp, s.a. de**  
**c.v.**  
Mesones No. 21 Col. Centro  
MEXICO D.F. 06080  
TEL: (905) 709 3716

### La Casa Wagner de

**Guadalajara s.a. de c.v.**  
Av. Corona No. 202 S.J.  
Guadalajara, Jalisco  
MEXICO C.P.44100  
TEL: (36) 13 1414

### VENEZUELA

**Musicland Digital C.A.**  
Av. Francisco de Miranda,  
Centro Parque de Cristal,  
Nivel C2 Local 20 Caracas  
VENEZUELA  
TEL: (2) 285 9218

### PANAMA

**Productos Superiores,**  
**S.A.**  
Apartado 655 - Panama 1  
REP. DE PANAMA  
TEL: 26 3322

### ARGENTINA

**Instrumentos Musicales**  
**S.A.**  
Florida 638  
(1005) Buenos Aires  
ARGENTINA  
TEL: (1) 394 4029

### HONG KONG

**Tom Lee Music Co., Ltd.**  
**Service Division**  
22-32 Pun Shan Street, Tsuen  
Wan, New Territories,  
HONG KONG  
TEL: 852 2 737 7688

### KOREA

**Cosmos Corporation**  
**Service Station**  
261 2nd Floor Nak-Won  
Arcade Jong-Ro ku, Seoul,  
KOREA  
TEL: (02) 742 8844

### SINGAPORE

**CRISTOFORI MUSIC**  
**PTE LTD**  
335 Joo Chiat Road  
SINGAPORE 1542  
REPUBLIC OF SINGAPORE  
TEL: 3450435

### PHILIPPINES

**G.A. Yupangco & Co. Inc.**  
339 Gil J. Puyat Avenue  
Makati, Metro Manila 1200,  
PHILIPPINES  
TEL: (02) 817 0013

### THAILAND

**Theera Music Co., Ltd.**  
330 Verng Nakorn Kasem,  
Soi 2, Bangkok 10100,  
THAILAND  
TEL: (02) 2248821

### MALAYSIA

**Bentley Music SDN BHD**  
No.142, Jalan Bukit Bintang  
55100 Kuala Lumpur,  
MALAYSIA  
TEL: (03) 2443333

### INDONESIA

**PT CITRARAMA**  
**BELANTIKA**  
Kompleks Perkantoran Duta  
Merlin Blok E No.6-7  
Jl. Gajah Mada No.3-5,  
Jakarta 10130,  
INDONESIA  
TEL: (021) 3850073

### TAIWAN

**Siruba Enterprise**  
**(Taiwan) Co., LTD.**  
Room. 5, 9th. No. 112 Chung  
Shan N.Road Sec.2 Taipei,  
TAIWAN, R.O.C.  
TEL: (02) 571 5860

### SOUTH AFRICA

**That Other Music Shop**  
**(PTY) Ltd.**  
11 Melle Street (Cnr Melle  
and Juta Street)  
Braamfontein 2001  
Republic of South Africa  
TEL: (011) 403 4105

### Paul Bothner (PTY) Ltd.

17 Werdmuller Centre  
Claremont 7700  
Republic of South Africa  
TEL: (021) 64 4030

As of Dec. 28. 1994

# Roland Corporation

00780378





 Roland®

---

**70566012**

UPC

70566012



18981

**Roland**