

StudioMix™



PEAVEY QuickStart





Intended to alert the user to the presence of uninsulated "dangerous voltage" within the product's enclosure that may be of sufficient magnitude to constitute a risk of electric shock to persons.



Intended to alert the user of the presence of important operating and maintenance (servicing) instructions in the literature accompanying the product.

CAUTION: Risk of electrical shock — DO NOT OPEN!

CAUTION: To reduce the risk of electric shock, do not remove cover. No user serviceable parts inside. Refer servicing to qualified service personnel.

WARNING: To prevent electrical shock or fire hazard, do not expose this appliance to rain or moisture. Before using this appliance, read the operating guide for further warnings.



Este símbolo tiene el propósito, de alertar al usuario de la presencia de "(voltaje) peligroso" que no tiene aislamiento dentro de la caja del producto que puede tener una magnitud suficiente como para constituir riesgo de corrientazo.



Este símbolo tiene el propósito de alertar al usuario de la presencia de instrucciones importantes sobre la operación y mantenimiento en la literatura que viene con el producto.

PRECAUCION: Riesgo de corrientazo — ¡No abra!

PRECAUCION: Para disminuir el riesgo de corrientazo, no abra la cubierta. No hay piezas adentro que el usuario pueda reparar. Deje todo mantenimiento a los técnicos calificados.

ADVERTENCIA: Para evitar corrientazos o peligro de incendio, no deje expuesto a la lluvia o humedad este aparato. Antes de usar este aparato, lea más advertencias en la guía de operación.



Ce symbole est utilisé pour indiquer à l'utilisateur la présence à l'intérieur de ce produit de tension non-isolée dangereuse pouvant être d'intensité suffisante pour constituer un risque de choc électrique.



Ce symbole est utilisé pour indiquer à l'utilisateur qu'il ou qu'elle trouvera d'importantes instructions sur l'utilisation et l'entretien (service) de l'appareil dans la littérature accompagnant le produit.

ATTENTION: Risques de choc électrique — NE PAS OUVRIR!

ATTENTION: Afin de réduire le risque de choc électrique, ne pas enlever le couvercle. Il ne se trouve à l'intérieur aucune pièce pouvant être réparée par l'utilisateur. Confier l'entretien à un personnel qualifié.

AVERTISSEMENT: Afin de prévenir les risques de décharge électrique ou de feu, n'exposez pas cet appareil à la pluie ou à l'humidité. Avant d'utiliser cet appareil, lisez les avertissements supplémentaires situés dans le guide.



Dieses Symbol soll den Anwender vor unisolierten gefährlichen Spannungen innerhalb des Gehäuses warnen die von Ausreichender Stärke sind, um einen elektrischen Schlag verursachen zu können.



Dieses Symbol soll den Benutzer auf wichtige Instruktionen in der Bedienungsanleitung aufmerksam machen, die Handhabung und Wartung des Produkts betreffen.

VORSICHT: Risiko — Elektrischer Schlag! Nicht öffnen!

VORSICHT: Um das Risiko eines elektrischen Schlages zu vermeiden, nicht die Abdeckung entfernen. Es befinden sich keine Teile darin, die vom Anwender repariert werden könnten. Reparaturen nur von qualifiziertem Fachpersonal durchführen lassen.

ACHTUNG: Um einen elektrischen Schlag oder Feuergefahr zu vermeiden, sollte dieses Gerät nicht dem Regen oder Feuchtigkeit ausgesetzt werden. Vor Inbetriebnahme unbedingt die Bedienungsanleitung lesen.

Introduction

Congratulations on purchasing the StudioMix, the best MIDI and digital audio solution for creating music and sound on your desktop PC! After a brief introduction, this QuickStart guide will show you how to install and use the StudioMix hardware and software.

What is the StudioMix™?

The StudioMix™ is a fully integrated software and hardware solution for creating music and sound productions on your Windows® PC. Peavey® and Cakewalk have engineered this package to give you the maximum control and flexibility during the creative process, combining the power of the Cakewalk Professional™ software sequencer with the tactile control of dedicated hardware all from your desktop!

Designed with speed and flexibility as the foremost requirements, the hardware and software communicate via standard MIDI (Musical Instrument Digital Interface) protocols and can be configured in mere seconds. You will never have to program difficult System Exclusive strings or read a detailed MIDI implementation chart to use the control surface and the software. All configuration of the hardware is handled on-screen, in a simple, intuitive manner.

Your StudioMix hardware is an adaptable, versatile surface that provides a tactile interface for mixing and control within the Cakewalk environment. All controls on the surface can be configured in a matter of seconds to fit your needs, within a single view. You can set it up to control eight MIDI or Audio tracks at a time, and you have the ability to switch between banks of eight tracks with a single button press. You can control playback and trigger commands from it, or use the Jog/Shuttle wheel to navigate through the project.

With the StudioMix, you can:

- Record up to 256 tracks of MIDI or Digital Audio.
- Playback up to eight digital audio tracks simultaneously.
- Synchronize with AVI, MPEG and QuickTime digital video, as well as videotape and film.
- Use powerful MIDI and digital audio editing features.
- Mix using real motorized faders and other controls.
- Process audio DirectX audio effects inserts (real time or offline).

Contents

This package includes the following components:

- Software CD - Cakewalk Professional 8™ for StudioMix
- StudioMix Hardware Surface and power cord
- Quick Start guide
- Registration and warranty card
- Various MIDI and audio cables for connecting the StudioMix digital work surface

System Requirements

In order to use the StudioMix, you will need a personal computer with the following:

- A Pentium® processor – 120 MHz minimum, 200 MHz recommended
- 16 MB of RAM minimum, 32 MB recommended
- A Windows sound card capable of 16-bit digital audio
- A MIDI interface (This may be part of your sound card, a separate expansion card or a parallel port interface.)

If you are unsure about any of the above components, please contact your PC vendor or manufacturer. If your PC doesn't meet any one of the above criteria, you won't get the full benefit of the StudioMix.

Registration and Warranty

Please take a moment right now to fill out the registration/warranty card and return it to the address indicated. This is very important and will give you access to technical support and warranty repair on the hardware components.

Getting Help

If you get stuck or have a problem that isn't covered by this QuickStart guide, you can use the software's built in help system at any time while the program is open. This help system is your complete reference and online user's guide for using the StudioMix and allows you instant access to the information you need.

To use the on-line system, press Function Key #1 (F1) on your computer keyboard while the Cakewalk application is running. If you are within a window or view, the help system will open to the associated topic for that view. To see the help index or table of context, choose **Help Topics** from the **Help** menu in the program.

In addition to the online help system and the Quick Start Guide, Cakewalk Professional 8 for StudioMix comes with eight multimedia tutorials (called Techniques) on various topics which can be accessed from the CD-ROM. To access these Techniques, insert the software CD into your computer's CD-ROM drive and select Techniques from the menu that appears. If no menu appears, choose Start-Run, type d:\AutoRun.exe (where d:\ is your CD-ROM drive), and click OK.

Technical Support

If you need more information than you can find in the online help, here are two great places to look:

- Check the Support page of our World Wide Web sites (www.cakewalk.com or www.peavey.com) for updated technical information and answers to frequently asked questions.
- Post messages to the Cakewalk user community using one of the Cakewalk news groups. For more information about the news groups, visit www.cakewalk.com.

You can also get technical support directly from Cakewalk. In order to obtain technical support, you must submit the product registration card that is included with your Cakewalk product, or register your product on our World Wide Web site. You can obtain technical support for this product in the following ways:

- E-mail your questions to support@cakewalk.com. Be sure to include your serial number and product name in your e-mail.
- Call Cakewalk Technical Support at (617) 441-7891 on weekdays, 10:00AM to 6:00PM, Eastern Time. Be sure to have your serial number ready when you call.

Technical support hours, policies, and procedures are subject to change at any time. Check our web sites for the latest support information.

Installation: Hardware

In this section, we will look at the StudioMix hardware and show you how to install it. If you have specific MIDI or digital audio installation questions, you should consult the software's online help system (see the topics under Advanced Setup).

Step 1: Identifying the Hardware Components

Your StudioMix includes the following hardware components:

- StudioMix hardware surface
- AC power cord
- Two (2) MIDI cables
- Six (6) phono cables
- One (1) dual-phono to stereo-mini cable
- One stereo-mini to stereo-mini cable

Step 2: Familiarizing Yourself with the StudioMix Hardware Surface

The hardware surface forms the tactile component of the StudioMix package, allowing you to abandon the mouse and computer keyboard when mixing, controlling the transport or triggering commands. To configure the setup of your hardware surface, you need to use the StudioMix Configuration view in the software, but let's introduce you to the hardware first.

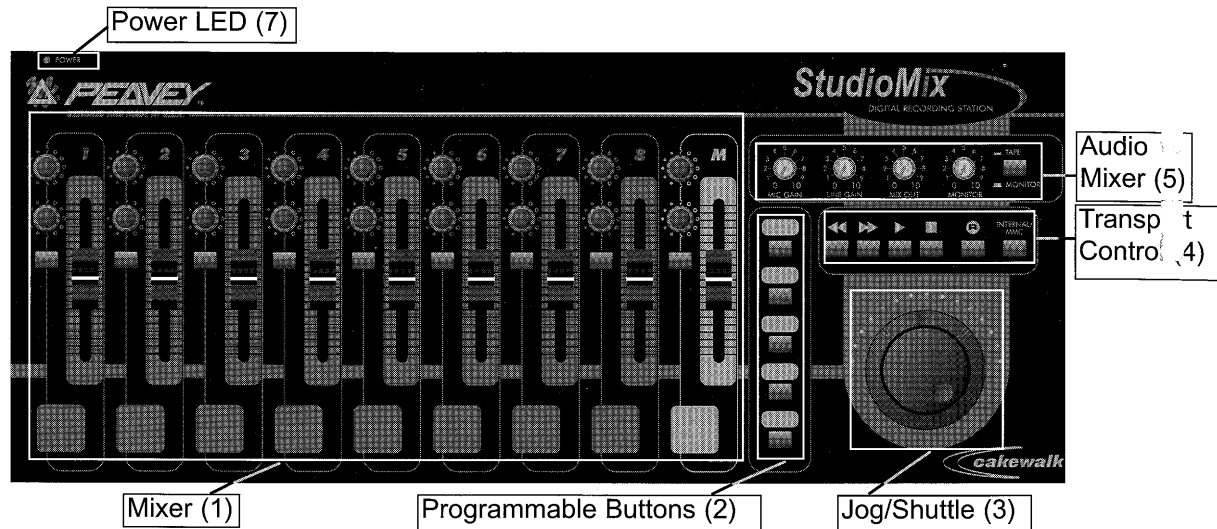

The surface can be separated into seven main areas:

1. **Mixer** — This section contains nine modules, each with a 60mm motorized fader, a button and two rotary encoder knobs. Modules numbered “1” through “8” control individual tracks in the software, while the module marked “M” controls the master section of the software mixer (aux masters and sound card outputs). Each type of control can be assigned to track parameters such as volume, pan, aux sends and other functions in the software.
2. **Programmable Buttons** — This section has five buttons that can be programmed to trigger various events or commands (called Button Bindings) in the software.
3. **Jog/Shuttle Control** — This dual-function control provides you with the ability to move the current time position of the sequencer. The inner wheel, called the Jog Wheel, moves forward or backward through the sequence by small, individual increments. The outer wheel, called the Shuttle Wheel, allows you to move rapidly forward or backward.
4. **Transport Controls** — This group of six buttons provides control over basic transport functions: (from left to right) Rewind, Fast-Forward, Play, Stop and Record. The furthest button to the right allows you to select whether this transport controls the software or external devices through MIDI Machine Control (MMC).

5. **Audio Mixer** — This section contains the controls for the analog audio mixer in the StudioMix hardware surface, providing a central connection between your microphones, instruments, computer sound card and monitoring (speaker) system. Additionally, you can connect the inputs and outputs of a cassette deck, DAT machine, sampler or any other stereo device to the audio mixer and monitor it separately. This section has the following controls:
 - **Mic In** — This sections the gain of the signal at the low-Z microphone input.
 - **Line In** — This controls the gain of both signals at the line inputs (left and right).
 - **Mix Out** — This controls the gain of the sound card output being sent to the tape output jacks.
 - **Monitor** — This controls the listening level, i.e. the signal being sent to the monitor and headphone outputs.
 - **Tape/Monitor** — This button selects either the tape or sound card as the source for the monitor and headphone output.

The signal flow of the audio mixer is shown on page 10 of this QuickStart guide.

6. **Back Panel** — This section contains the audio, MIDI, and power connections for the unit.
 - **Headphone Output** — Connection for a pair of headphones; volume is controlled by the Monitor gain control.
 - **Monitor Out** — Stereo connection to a power amplifier or pair of powered speakers; volume is controlled by the Monitor gain control.
 - **Tape In** — These jacks connect to the outputs of the external stereo device and bring that signal into the audio mixer.
 - **Tape Out** — These jacks connect to the inputs of the external stereo device and send the sound card signal (after the Mix Out gain control) to the external deck.
 - **Sound Card In** — These jacks connect to the outputs of the stereo sound card and bring that signal into the audio mixer.
 - **Sound Card Out** — These jacks connects to the inputs of the stereo sound card and send the mixed signals from the Mic and Line Inputs (after their respective gain controls) to the card.
 - **Line Inputs** — Connect these jacks to the unbalanced line outputs on your instruments.
 - **Mic Input** — Connect this jack to your microphone.
 - **MIDI In** — This port accepts data from the software to be interpreted by the StudioMix hardware surface.
 - **MIDI Out** — This port transmits all of the data generated by the StudioMix hardware surface.
 - **MIDI Thru** — This port will output data received at the StudioMix's MIDI In connection to another MIDI capable device.
 - **Power Connector** — This is the power cord receptacle. Use the provided AC power cord to connect the StudioMix hardware surface to a wall outlet or AC power connection.
7. **Power LED** — Last, but certainly not least, we have the Power LED in the upper left corner of the surface. This LED should be glowing when the unit is powered.

Step 3: Connecting Your StudioMix hardware surface

Your StudioMix hardware surface not only provides control over functions in Cakewalk, but also acts as a simple audio mixer, providing connections between audio sources, your computer sound card, a playback/recording device (like a cassette deck) and your monitoring system. This allows you to control the input and output levels of the digital audio in Cakewalk Professional.

This section explains each of the above connections, giving diagrams and examples. While your individual setup may differ, these examples will provide a basic understanding of how to connect the StudioMix hardware with the other equipment in your studio. StudioMix also provides some adapter cables to help you get connected faster than ever before.

Connecting Power — Plug in the StudioMix using the supplied AC power cord.

Connecting StudioMix to Audio Sources (Microphones, Guitars, Keyboards, etc.)

The StudioMix has a single, low-impedance microphone input and a stereo unbalanced line input for connecting to keyboards, synthesizers, guitars, guitar processors or any other line level signal.

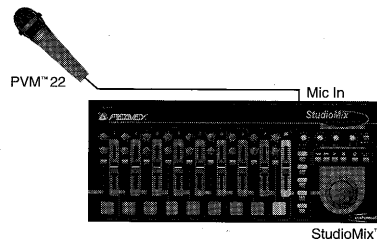

As shown, a microphone is plugged into the Mic In of the StudioMix. You can control the level of this microphone using the Mic Gain knob in the mixer section. See the Signal Flow diagram on Page 10 for more detailed information.

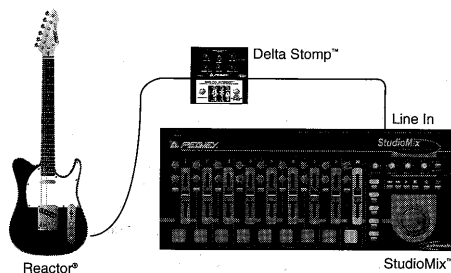
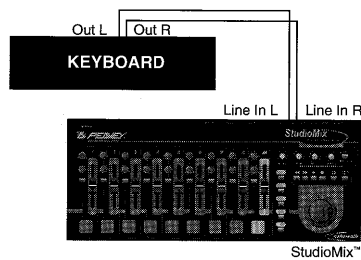

The diagrams on Page 8 show the outputs of a keyboard plugged into the Line In of the StudioMix. You can control the level of this signal to the sound card using the Line Gain knob in the mixer section. See the *Signal Flow Diagram* on Page 11 for more detailed information.

Connecting Your Computer's Sound Card to StudioMix

The StudioMix hardware has a set of stereo inputs and outputs for connecting your sound card. The line inputs and microphone input are mixed together and sent to the jacks labeled "Sound Card Out", which connects to the input on your computer's sound card. Connect the jacks labeled "Sound Card In" to the outputs of the computer's sound card.

If you wish to hear the sound card through the Monitor output of the StudioMix, make sure that the Tape/Monitor button (located to the far right of the mixer controls) is in the "Up" position.

Connect the StudioMix with the sound card in the following manner:

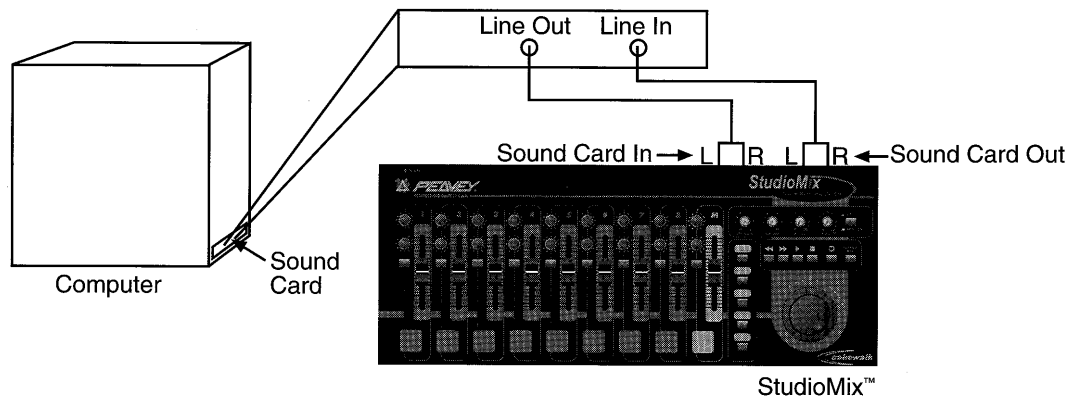

Connecting a Stereo Recording/Playback Device to StudioMix

StudioMix allows you to connect the inputs and outputs of a stereo recording/playback device, such as a cassette deck or 2-track recorder. The jacks labeled "Tape Out" will connect to the inputs of your tape deck and receive signal from the computer's sound card (through the StudioMix). Connect the jacks labeled "Tape In" to the outputs of the tape deck so that you can monitor it through the StudioMix.

If you wish to hear the tape output through the Monitor output of the StudioMix, make sure that the Tape/Monitor button (located to the far right of the mixer controls) is in the "Down" position.

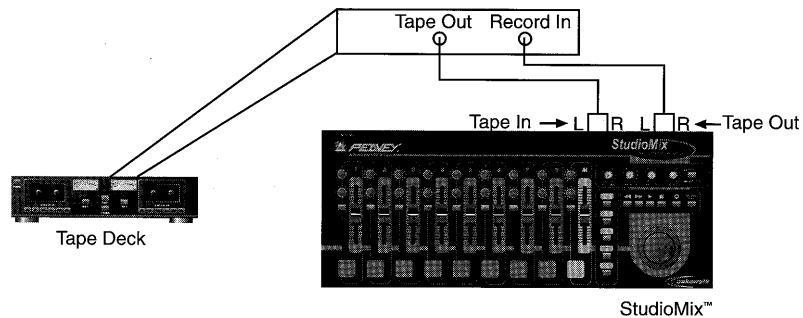

Connecting StudioMix to a Monitoring System

Once you have connected the audio inputs and outputs to the StudioMix, you should connect the monitor output to a playback system such as a set of powered desktop speakers, a power amplifier or your home stereo. Connect the jacks labeled “Monitor Out” to the inputs of your monitoring system. The control labeled “Monitor” will control the amount of signal fed to these outputs. Depending on the setting of the “Tape/Monitor” button (located to the far right of the mixer controls), the output of the StudioMix will be sourced from the sound card or tape input.

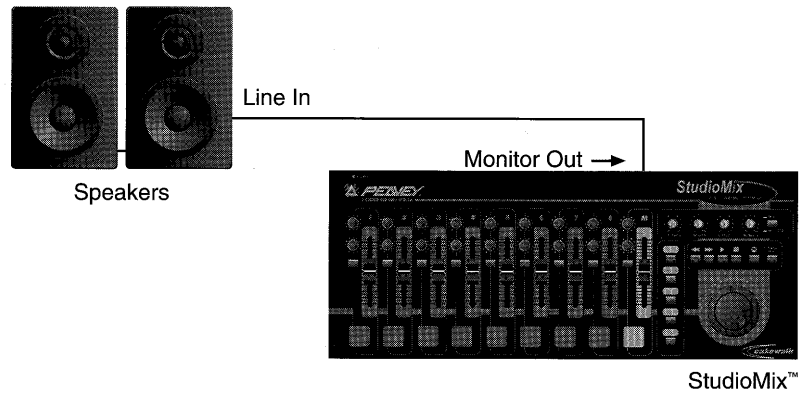

Connecting Headphones

The StudioMix hardware surface also provides a headphone output so that you can use it without disturbing your neighbors. The control labeled “Monitor” will control the amount of signal fed to the headphone output (as well as the Monitor Outs). Depending on the setting of the “Tape/Monitor” button (located to the far right of the mixer controls), the output of the StudioMix will be sourced from the sound card or tape input.

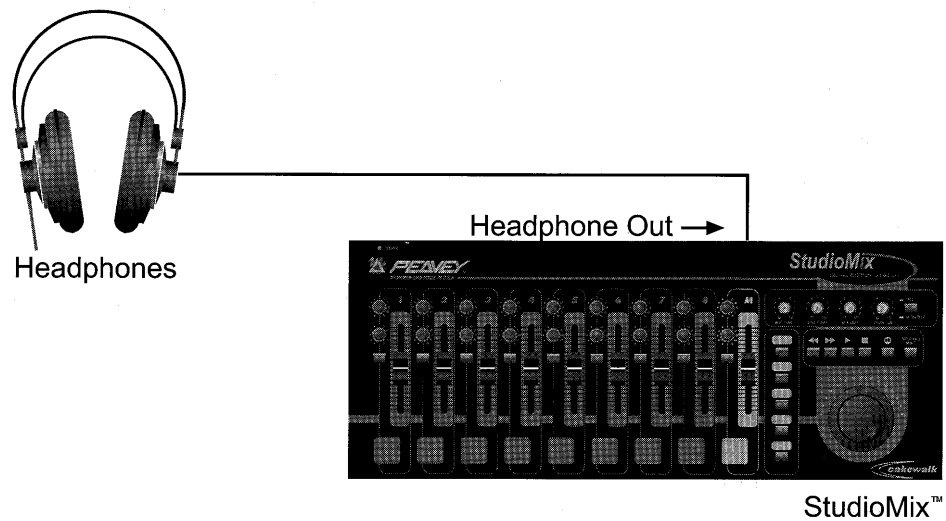

Signal-Flow Diagram for the Audio Mixer

The following diagram shows the electrical signal flow for the audio mixer in the StudioMix hardware surface:

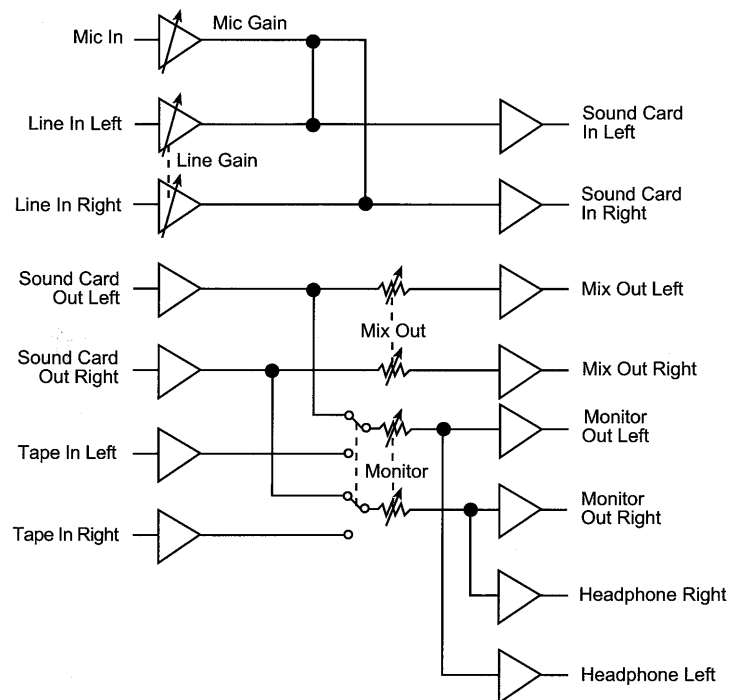

Using the Audio Mixer on the StudioMix

The StudioMix hardware control surface has a small audio mixer that provides basic signal handling between your computer and the other equipment in your setup. This section explains a little more about it.

There are four knobs and a button in the mixer section:

- **Mic Gain** — This knob controls the amount of microphone signal sent to the sound card.
- **Line Gain** — This knob controls the amount of line signal sent to the sound card
- **Mix Out** — This knob controls the amount of signal sent from the sound card to the external stereo deck (tape out).
- **Monitor** — This knob controls the amount of signal sent to the playback system (monitor or headphones). Its source depends on the position of the Tape/Monitor button.
- **Tape/Monitor button** — This button selects the source for the monitor outputs, choosing between the sound card and the tape input.

Basically, the idea behind the StudioMix analog mixer is to let you connect audio sources, control their gain being sent to the sound card inputs, and then hear the output of the sound card (using the monitor gain control). Plus, you can connect a stereo tape deck and record from the sound card outputs, with the option of monitoring the output of the tape deck.

Connecting MIDI Equipment

In order to use Cakewalk Professional for StudioMix with your MIDI gear, you will need to connect the StudioMix hardware surface to your computer via MIDI. How you set this up depends on the type of MIDI interface you are using and any additional MIDI equipment (synthesizers, drum machines) that you wish to connect.

Note: The MIDI In and Out of the StudioMix **must** be connected to the appropriate jacks on your MIDI interface in order for it to work properly.

It is possible to connect your equipment in some rather complex ways that may cause problems. If you call for technical support with a problem concerning equipment that doesn't seem to be responding, we will probably suggest that you reconnect using the steps listed below before we explore the problem further. Also be sure to check connections and make sure that you followed all of the installation procedures correctly before calling.

There are two general types of MIDI interfaces:

- **Single Port** — This type of interface has only one MIDI In and one MIDI Out connection.
- **Multiple Port** — This type of interface has more than one MIDI In and one MIDI Out connection.

Note: A MIDI "port" consists of a MIDI In connector and a MIDI Out connector. If you have one MIDI port in your system, you will have two connectors; two MIDI ports have four connectors, etc.

Based on this, there are three setup situations that are usually encountered:

- You are using a multiple port MIDI interface with the StudioMix and other external MIDI devices (keyboards and synths).
- You are using a single port MIDI interface with the StudioMix only.
- You are using a single port MIDI interface with an external MIDI keyboard and the StudioMix.

In order to use the StudioMix digital work surface in any of the above situations, you will need to connect it as follows:

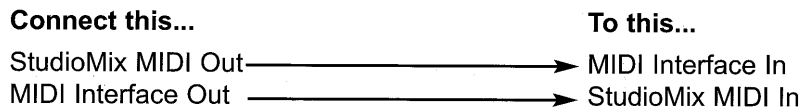

For multiple port MIDI interfaces, the StudioMix can be connected to any unused MIDI port. If you are using a single port interface such as the type usually found on a sound card, you will need to do some special configuring of your MIDI setup in order use the StudioMix. This special configuration will depend on your situation.

If you are only using the internal MIDI synthesis capabilities of your sound card, you can use the single MIDI port (input and output) to connect your StudioMix digital work surface, as described in the table on bottom of Page 11.

In situations where you will be using a MIDI sound module or synthesizer for playback only, the StudioMix connects as described in the table above, but you can connect the MIDI Thru of the StudioMix to the sound module or synthesizer's MIDI In as follows:

Connect This... **To This...**
 StudioMix MIDI Thru —————> MIDI In on the module or device

In situations where you need to record MIDI from a keyboard, Guitar-to-MIDI converter or MIDI wind controller, it is recommended that you use a MIDI interface with multiple ports so that you do not have to reconfigure your setup when you wish to record.

The following setups show the general configuration of MIDI devices on a single port MIDI interface. They apply to MIDI devices that have the following ports:

- All three types of MIDI jacks: In, Out, and Thru (such as the StudioMix)
- Only two types of MIDI jacks: In and Out

If you have only one external MIDI control device- the StudioMix, for example- read the *If Your Keyboard Doesn't Have a MIDI Thru Jack* section on Page 14 (regardless of whether you have MIDI Thru or not).

If Your Keyboard Has a MIDI Thru Jack

If your keyboard or MIDI control device has three MIDI jacks--In, Out, and Thru--then use the following diagram:

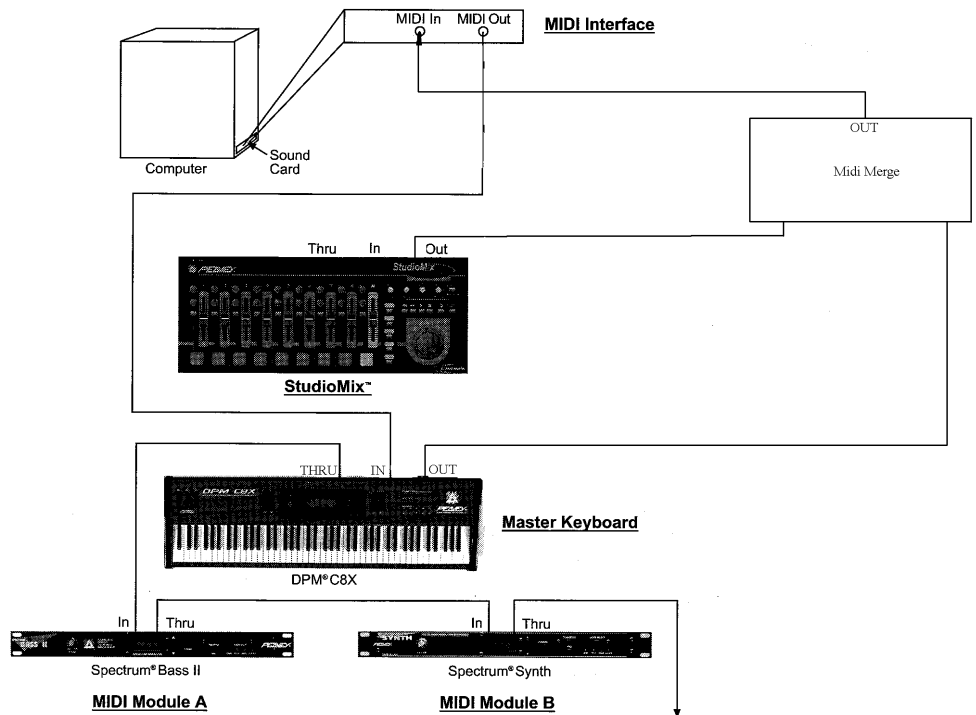

If you are using a 15-pin joystick adapter cable that splits into two MIDI cables:

- Connect the 15-pin jack to your computer's joystick port.
- Connect the "In" cable to your instrument's MIDI Out jack.
- Connect the "Out" cable to your instrument's MIDI In jack.

Here is a checklist:

Connect This...	To This...
Master keyboard Out	MIDI Merger
MIDI interface Out	StudioMix MIDI In
StudioMix MIDI Out	MIDI Merger In 1/2
Master keyboard MIDI Out	MIDI Merger In 1/2
Merger MIDI Out	Interface MIDI In
Master keyboard Thru	Another MIDI module's In
That MIDI module's Thru	Yet another MIDI module's In

Note: A MIDI Merger merges, or combining two MIDI inputs to one MIDI output.

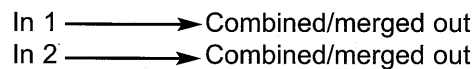

A MIDI merger can be purchased at your local music store.

Continue the sequence, repeating the last connection for each of your sound modules. Each MIDI device should be set to a unique MIDI channel or range of channels to avoid note-doubling. Refer to the manuals for your MIDI devices for information on how to set their MIDI channels.

Your MIDI interface may have a Thru jack as well as In and Out jacks. If your master keyboard lacks MIDI Thru, you can add more MIDI modules to your setup by connecting the MIDI interface's Thru to the first module's In. You can then chain subsequent modules onto the first module, as described earlier.

Doubled Notes and Associated Problems

If your master keyboard now seems to double-note (They sound "Thicker".), or if you can play only one half as many at once, first make sure that no MIDI channel is being used by more than one of your MIDI devices. If no MIDI channel is assigned to duplicate devices and you hear doubling or only half as many notes as you should, you may have to do one of the following:

- **Turn off Local Control on Your Keyboard:**

The best way to resolve the problem is to disable Local Control on the keyboard, following the instructions that came with the keyboard. This stops the keyboard from playing independently. The keys you play still produce sound on the keyboard because they are echoed back by the MIDI interface. In many cases, Cakewalk disables local control automatically when the program is started, but this is not always possible.

- **Turn off MIDI Echo in Cakewalk:**

An alternate solution is to disable echoing within Cakewalk, as follows:

1. Choose Tools-Project Options and click the MIDI Input tab.
2. Under Echo Mode, check None.
3. Click OK when you are done.

This alternate solution may cause other problems if you are working with several MIDI devices at once.

It is also possible that your keyboard is transmitting information on two channels at once. To see if this is so, create a new project and record two notes from the keyboard. Then look at what you have recorded in the Event list view. If you see four notes displayed instead of two, then your keyboard is transmitting on two channels. See the documentation for your keyboard to learn how to correct the problem.

When you enable the StudioMix hardware control surface in Cakewalk, the software automatically turns off MIDI Echo for channel 16 of whichever port the StudioMix is assigned.

If Your Keyboard Doesn't Have a MIDI Thru Jack

If your keyboard has only two MIDI jacks--In and Out--or if you have only one keyboard, use the following diagrams:

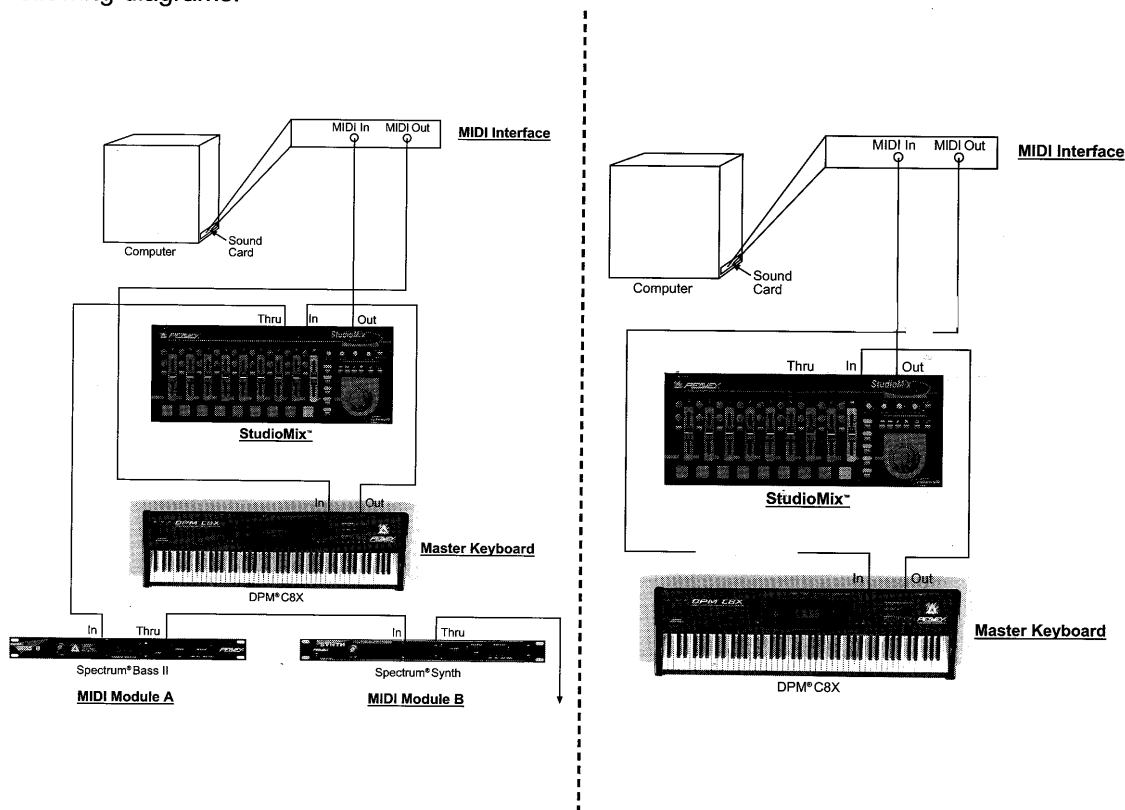

Each MIDI device should be set to a unique MIDI channel or range of channels to avoid note-doubling. Refer to the manuals for your MIDI devices for information on how to set their MIDI channels.

Installation: Software

This section will take you through the software installation process and get you started using the StudioMix. In this section, when we refer to the software as “Cakewalk” we are talking about the Cakewalk Professional for StudioMix software that comes in the StudioMix package.

Note: If you’re a current Cakewalk Pro Audio® or Cakewalk Professional® user, you may not need to install any software to use the StudioMix hardware surface. See below for additional instructions. If you do not have either of these products installed, then continue to Step 1 below.

If you are a Cakewalk Pro Audio 8 or Cakewalk Professional User... your StudioMix software installation CD contains an updater that will make sure your software is ready to use the StudioMix hardware. Follow the installation instructions listed in Step 2 below. When you get to the installer start screen, choose “Update My Software”. This will automatically detect and update your software to work with the StudioMix hardware.

If you are running a previous version of Cakewalk Professional... you will need to install the Professional for StudioMix software. Important: To prevent any loss of data, you may want to install to a different directory...Here is how to do it:

1. Begin the installation described in Step 1 below.
2. When the directory dialog appears, select a different folder for your latest version of Professional.

If you own any version of Cakewalk Home Studio... you need to install the Professional for StudioMix software. (Proceed to Step 1 below.)

Step 1. Before You Install

Before installing the software, make sure that Windows 95, 98, or NT is installed properly.

Note: Try some of the sample programs that come with Windows, such as Media Player and Sound Recorder. If you experience problems, try to resolve them before installing the StudioMix software, using the technical support services provided by Microsoft or your system vendor.

Step 2. Installing the Software

1. Start your computer and start Windows. Close any open programs, but leave Windows running.
2. Place the Cakewalk Professional for StudioMix CD-ROM in your CD-ROM drive.
3. After a few seconds, the AutoRun starts automatically, showing you a dialog box with several buttons. Click the Install.Cakewalk button, and a dialog box will appear that welcomes you to Cakewalk Setup.

Note: If you exit Setup without completing the installation, do not see the setup dialog after a short length of time, or do not have AutoRun enabled, choose **Start-Run**, type **d:/AutoRun.exe** (where **d:** is your CD-ROM drive), and click OK. This will reopen the AutoRun window, and you can click Install Cakewalk to start installation.

- **Turn off MIDI Echo in Cakewalk:**

An alternate solution is to disable echoing within Cakewalk, as follows:

1. Choose Tools-Project Options and click the MIDI Input tab.
2. Under Echo Mode, check None.
3. Click OK when you are done.

This alternate solution may cause other problems if you are working with several MIDI devices at once.

It is also possible that your keyboard is transmitting information on two channels at once. To see if this is so, create a new project and record two notes from the keyboard. Then look at what you have recorded in the Event list view. If you see four notes displayed instead of two, then your keyboard is transmitting on two channels. See the documentation for your keyboard to learn how to correct the problem.

When you enable the StudioMix hardware control surface in Cakewalk, the software automatically turns off MIDI Echo for channel 16 of whichever port the StudioMix is assigned.

If Your Keyboard Doesn't Have a MIDI Thru Jack

If your keyboard has only two MIDI jacks--In and Out--or if you have only one keyboard, use the following diagrams:

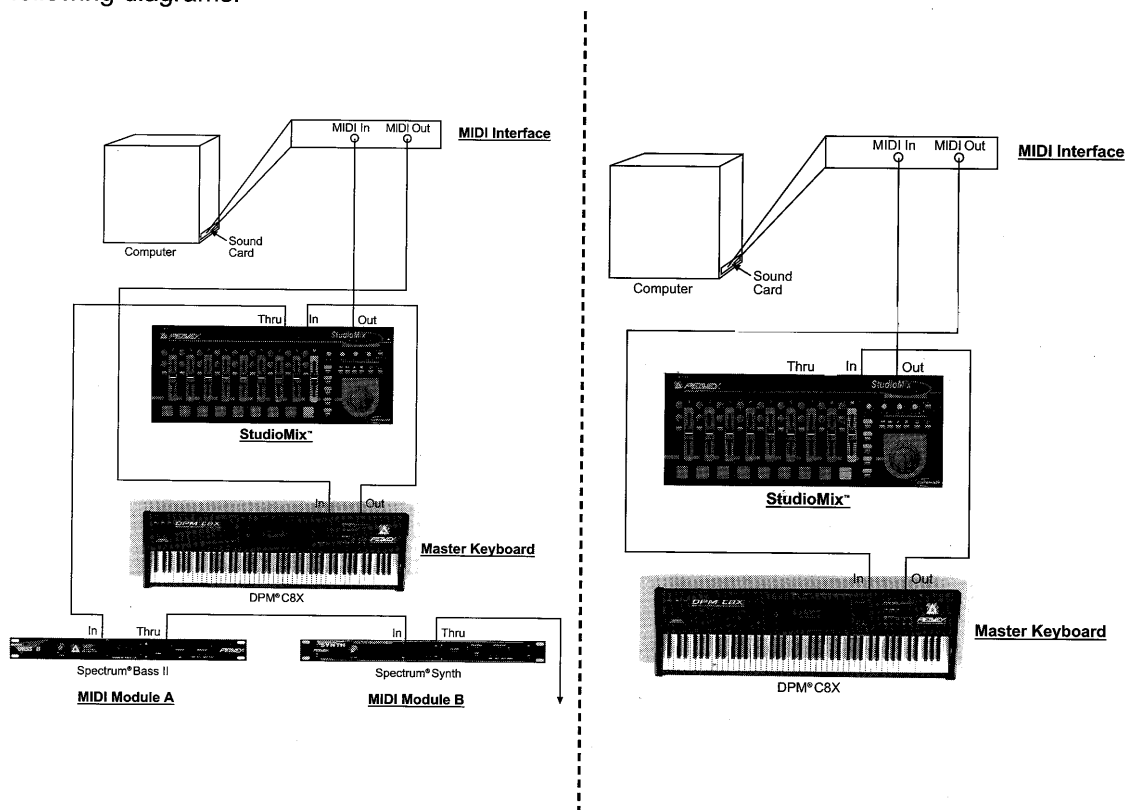

Each MIDI device should be set to a unique MIDI channel or range of channels to avoid note-doubling. Refer to the manuals for your MIDI devices for information on how to set their MIDI channels.

Installation: Software

This section will take you through the software installation process and get you started using the StudioMix. In this section, when we refer to the software as “Cakewalk” we are talking about the Cakewalk Professional for StudioMix software that comes in the StudioMix package.

Note: If you’re a current Cakewalk Pro Audio® or Cakewalk Professional® user, you may not need to install any software to use the StudioMix hardware surface. See below for additional instructions. If you do not have either of these products installed, then continue to Step 1 below.

If you are a Cakewalk Pro Audio 8 or Cakewalk Professional User... your StudioMix software installation CD contains an updater that will make sure your software is ready to use the StudioMix hardware. Follow the installation instructions listed in Step 2 below. When you get to the installer start screen, choose “Update My Software”. This will automatically detect and update your software to work with the StudioMix hardware.

If you are running a previous version of Cakewalk Professional... you will need to install the Professional for StudioMix software. Important: To prevent any loss of data, you may want to install to a different directory...Here is how to do it:

1. Begin the installation described in Step 1 below.
2. When the directory dialog appears, select a different folder for your latest version of Professional.

If you own any version of Cakewalk Home Studio... you need to install the Professional for StudioMix software. (Proceed to Step 1 below.)

Step 1. Before You Install

Before installing the software, make sure that Windows 95, 98, or NT is installed properly.

Note: Try some of the sample programs that come with Windows, such as Media Player and Sound Recorder. If you experience problems, try to resolve them before installing the StudioMix software, using the technical support services provided by Microsoft or your system vendor.

Step 2. Installing the Software

1. Start your computer and start Windows. Close any open programs, but leave Windows running.
2. Place the Cakewalk Professional for StudioMix CD-ROM in your CD-ROM drive.
3. After a few seconds, the AutoRun starts automatically, showing you a dialog box with several buttons. Click the Install.Cakewalk button, and a dialog box will appear that welcomes you to Cakewalk Setup.

Note: If you exit Setup without completing the installation, do not see the setup dialog after a short length of time, or do not have AutoRun enabled, choose **Start-Run**, type **d:/AutoRun.exe** (where **d:/**is your CD-ROM drive), and click OK. This will reopen the AutoRun window, and you can click Install Cakewalk to start installation.

4. When Setup starts, a dialog box welcomes you to the Cakewalk Professional for StudioMix Setup. Follow the prompts in the setup program to install the Cakewalk Professional for StudioMix software, clicking the Next button to continue through the installation process.

Cakewalk can be uninstalled from the Add/Remove Programs section of the Windows Control Panel. Any .MID files on your system may still be registered as Cakewalk files after you do this; if you still need to open the .MID files, you can register them with other applications. See your Windows documentation for more on registering files.

Step 3. Read the README File

Cakewalk Setup installs a README.RTF file in the directory where you installed the software and a shortcut found in the **Start** menu. Choose this to view the file; it contains important notes about changes or additions not covered in this QuickStart guide.

Step 4. Install a MIDI and Audio Driver

If you have already installed Windows multimedia MIDI or sound card drivers, you can skip this section. Just make sure that there are no conflicts between the driver and the sound card.

Cakewalk uses the multimedia extensions in Windows to “talk” to MIDI interfaces and sound cards. The multimedia extensions provide a way for applications to talk to different kinds of MIDI interfaces and sound cards through drivers. For Cakewalk to work with your device, you must use the Control Panel to install a driver. If you run into problems that seem to be driver related, please contact the manufacturer of your multimedia device for specific information about Windows drivers, configuration, and compatibility.

Be sure that the driver you install is the correct one for your MIDI interface. The Cakewalk CD contains a driver for MPU-401 compatible MIDI interface cards. If you have such a MIDI interface card installed in your system, you should install this driver using the steps listed here. However, if your MIDI interface is not MPU-401 compatible, or if your MIDI interface is provided by your sound card, then you must not use this MPU-401 compatible driver for your MIDI interface. It will not work properly. Instead, use the MIDI driver provided with your MIDI interface card or sound card. Consult your card’s accompanying documentation to determine which driver to use and how to install and configure that driver on your operating system.

If you plan to record and play back digital audio on a Windows-compatible sound card, make sure you have installed the wave driver for that sound card. Also make sure that you install a 16-bit sound card.

If you have followed the above guidelines and you are having problems with your sound card or MIDI interface, contact the card’s manufacturer.

Step 5. Configure Your MIDI Hardware

In the hardware installation section of this QuickStart guide, you connected your MIDI devices (such as synths, samplers, controllers, or the StudioMix hardware surface) to the computer via a MIDI interface. Make sure that you have correctly configured your MIDI devices internally to respond and/or transmit MIDI data as appropriate. Consult your MIDI device’s documentation if you are unsure of any settings.

Step 6. Configure Your Audio Hardware

To use the audio features of Cakewalk, you must have a 16-bit sound card. Older, 8-bit sound cards cannot take advantage of Cakewalk's features.

The first time you start Cakewalk, it will automatically run the Wave Profiler utility. Wave Profiler determines the proper settings for your sound card and writes them to a file that Cakewalk consults to use the card. To find out if your sound card is compatible with Cakewalk, check the sound card's documentation.

Step 7. Set Up to Record Digital Audio

Most sound cards use the Windows Volume Control to adjust the master input and output volumes and to control which recording inputs are active. If you don't hear audio tracks, or if you can't easily control the audio volume in Cakewalk, go to **Start-Accessories-Volume Control** and check the settings there. Some sound cards have their own independent mixer utility to control these volumes. See your sound card's documentation for more information. Your StudioMix has an audio section to allow you to easily connect audio signals to and from the computer's sound card. For more information, see the *Installation: Hardware* on Page 5, or *Connecting StudioMix to Audio Sources* on Page 7.

Your First Session with the StudioMix

Before you begin, make sure you have the correct version of Professional or Pro Audio installed. Now that you have the hardware and software installed, this section will show you how to start the Cakewalk software for the first time. It will also show you how to access the online tutorial which will give you some hands-on practice learning how to play, record, and mix your projects using the Cakewalk Professional for StudioMix software and the hardware surface.

If you are not already familiar with Cakewalk products, you may want to start with the online tutorials.

Starting Cakewalk for the First Time

When you installed Cakewalk, the default setup procedure added a Cakewalk folder to your **Programs** menu.

1. Click the **Start** button located in the lower left corner of the screen.
2. Point to **Programs** to see a list of available programs and folders.
3. Point to the **Cakewalk** folder to open it.
4. Click on the **Cakewalk** program item.

You can also start Cakewalk by Select the Cakewalk program item or a Cakewalk document file using the My Computer icon on the desktop, the Windows Explorer, or the **Find** menu. All Cakewalk file types (.WRK, .BUN, .TPL, .CAL, .MID, .MFF) are registered with Windows. See your Windows documentation or online help for more information.

Migrating Preferences

The first time you run Cakewalk, it asks if you want it to search for an older version of Cakewalk and transfer (or "migrate") the preferences you established in that version to Cakewalk. Cakewalk searches all hard disks in your system for older versions, and if you have more than

one older version of Cakewalk installed, Cakewalk presents a list of them. You may choose one from this list. The preferences and settings stored in the older versions CAKEWALK.INI and TTSSEQ.INI files are then transferred to the identically named configuration files for Cakewalk. Cakewalk migrates certain preferences to the Windows Registry rather than to the CAKEWALK.INI file.

Running Wave Profiler

The first time you start Cakewalk, it automatically runs the Wave Profiler utility. Wave Profiler determines the proper MIDI and Audio timings for your sound card and writes them to a file that Cakewalk refers to when using the card. Wave Profiler does not change the sound card's DMA, IRQ, or port address settings.

Wave Profiler attempts to detect the make and model of your sound card, which determine the card's audio characteristics. When Wave Profiler determines the kind of card you have, it asks whether you want to use the default settings for that card or override them. If Wave Profiler has identified your sound card correctly, you may accept the default settings. However, the utility is not infallible. If it does not identify your sound card correctly, you must enter the correct settings yourself. To determine those settings, you may need to consult your sound card's manual.

Note: You can run the Wave Profiler again at a later time (for example, if you install a new sound card or driver) by choosing the **Tools-Audio Options** command and clicking Wave Profiler.

Setting Up the MIDI In and MIDI Out Devices

When you start Cakewalk for the first time, it checks your computer to find all the MIDI input and output devices you have installed (such as sound cards and MIDI interfaces). However, sometimes you need to tell Cakewalk exactly which devices you want it to use. If you are not getting sound from your sound card or MIDI keyboard, or if you just want to change the MIDI ports and devices that you are using, follow the steps in this section.

Choose **Tools-MIDI Devices** to open a dialog box in which you select the MIDI In and MIDI Out devices that Cakewalk will use. Each item in the list is a MIDI In or MIDI Out port from drivers installed using the Windows Control Panel.

1. Go into Cakewalk and choose Tools-MIDI Devices. You will see the MIDI Ports dialog box, which lets you choose instruments on MIDI input and output ports.
2. Look at the left window. Notice that it shows devices on MIDI Input Ports; make sure that all devices in this window are highlighted. If a device is not highlighted, click on it once to select it for MIDI Input.
3. Look at the window on the right. Notice that it shows devices on MIDI Output Ports. Cakewalk numbers its MIDI Output Ports by the order of the devices in this window. The device on top is on Port 1, the one below it is on Port 2, and so on.
4. Highlight each device in the Output Ports window and click Move Selected Devices to Top to change its order. Then highlight all the devices that appear in the window to select them for output.

Tip: Be sure to choose MIDI output devices from **Tools-MIDI Devices**. If you do not do this, you will not be able to hear any of your MIDI instruments when you play songs in Cakewalk.

If you later add or remove drivers using the Drivers icon of the Windows Control Panel, Cakewalk reacts in the following way:

- If you remove a Control Panel driver, Cakewalk will not use the device it belongs to the next time you run the program. Any other devices you had selected using the **Tools-MIDI Devices** command will remain selected.
- If you add a driver through the Control Panel, Cakewalk does not automatically use it. You must use the **Tools-MIDI Devices** command to add the new driver to Cakewalk's list.

Note: After you add or remove a driver with the Drivers icon in the Windows Control Panel, you must restart Windows for the change to take effect.

Defining Your MIDI Instrument or Sound Card

Once you have selected your MIDI Input and Output devices, Cakewalk, by default, plays back MIDI sequences using a General MIDI instrument definition. If you are using a synthesizer or sound card that does not adhere to the General MIDI standard, you may want to define that instrument later on. For information about instrument definitions, consult the **Instrument Definitions** topic in the online help system.

Support for Multiple Wave Drivers

Cakewalk will make use of one wave driver for playback and one for recording. This means that you can use one sound card for recording and a different one for playback. This is good if you need to hear audio that you previously recorded while you record new audio. (If you have only one sound card that lets you do this, it is called a "full-duplex" sound card.)

You might be thinking, "Great! Now I use a pair of SoundBlasters to do 'full-duplex' recording." However, there is no guarantee that two different cards will stay in sync. Only multiple drivers on the same card can ever truly be in sync.

If you have more than one installed sound card, Cakewalk has to designate one card as the playback device and one card as the record device. You choose these devices by entering values for Playback Wave Device and Record Wave Device in **Tools-Audio Options**.

Some sound cards with built-in modems come with a wave driver for internet audio or computer speaker phones. These drivers may cause the Wave Profiler to show errors and may prevent Cakewalk from running properly. You may need to remove these drivers before starting Cakewalk.

If you have more than one wave driver per sound card or multiple sound cards on your system, you may only choose one of these at a time in Cakewalk Professional. If you need to use multiple wave driver outputs simultaneously, you should upgrade to Cakewalk Pro Audio.

To access these tutorials, click "Getting Started" in the Quick Start dialog box (if it is open) or choose Help Topics from Cakewalk's Help menu, click on the Contents tab and double-click on the Tutorials item in the list. This will open that section and from here you can double-click on the Tutorials page to begin running the first tutorial.

The StudioMix tutorial is available to help guide you through your first use of the hardware control surface.

Enabling StudioMix

In order to use the StudioMix hardware controller with your software, you must enable it. Follow this procedure to enable StudioMix with your Cakewalk product.

1. Select Tools | Global Options.
The Global Options dialog box appears.
2. In the General tab, check the Enable StudioMix Controller box.
3. Click OK.

The software now knows to configure itself to work with the StudioMix hardware. When this check box is enabled, MIDI Echo will be disabled on MIDI channel 16 and MIDI controller messages will not be recorded on that channel.

Dive in

After all of these setup details have been configured, you may see a Quick Start dialogue box that gives you a number of different ways to get started using Cakewalk. You can dive right in at this point, or begin by going through the online tutorials. If you are new to Cakewalk products, we recommend that you run through the online tutorials and multimedia Techniques. These will help introduce you to the software by real examples.

To access these tutorials, close the Quick Start dialog box (if it is open) and choose **Help Topics** from Cakewalk's **Help** menu. Click on the Contents tab and click on the **Getting Started** item then the **Tutorials** item in the list. This will open that section, and from here you can double-click on the Tutorials page to begin running the first tutorial.

If you get stuck or need help at any point when using StudioMix, remember that you have an extensive online help system that you can access by pressing F1 or choosing **Help Topics** from the **Tools** menu. Use the contents, index or find functions to get the information you need.

Templates

When creating your own projects, we have provided three templates to help you get started quickly. StudioMix templates each have eight tracks with pre-assigned tracks. There are three StudioMix templates, one with eight audio tracks, one with eight MIDI tracks, and one with four audio tracks and four MIDI tracks.

To Open a StudioMix template:

1. Select File | Open. The Open dialog box appears.
2. Select Cakewalk Template from the Files of Type drop down list.
3. Select one of the following:
 - StudioMix 4+4.tpl
 - StudioMix 8 Tracks Audio.tpl
 - StudioMix 8 Tracks MIDI.tpl
4. Click OK.

STUDIOMIX SPECIFICATIONS

Input Specifications:

Function	Input Z (ohms) Min.	Max. Gain	Input Levels			Bal./ Unbal.	Connector
			Min.**	Nominal*	Max.		
Mic	2.2 k	47 dB	-47 dBu	-24 dBu	0 dBu	Bal.	XLR Pin 1 Ground Pin 2 (+) Pin 3 (-)
Line	10 k	14 dB	-14 dBu	0 dBu	+20 dBu	Bal.	RCA
Sound Card	10 k	15 dB	-15 dBu	0 dBu	+20 dBu	Bal.	RCA
Tape	10 k	15 dB	-15 dBu	0 dBu	+20 dBu	Bal.	RCA

0 dBu = 0.775V (RMS)

** Min. input level (Sensitivity) is the smallest signal that will produce nominal output (0 dBu) with level/gain control set for maximum gain.

* Nominal settings are defined as all controls set at 0 dB, or 50% rotation.

Output Specifications:

Function	Minimum Load Z (ohms)	Output Level		Bal./ Unbal.	Connector
		Nominal	Max.		
Sound Card	1 k	0 dBu	+19 dBu	Unbal.	RCA
Tape	1 k	0 dBu	+19 dBu	Unbal.	RCA
Monitor	1 k	0 dBu	+19 dBu	Unbal.	RCA
Headphone	1 k	0 dBu (no load)	+16 dBu	Unbal.	1/8" TRS: Tip Left Ring Right, Sleeve Ground

0 dBu = 0.775V (RMS)

Frequency Response:

Mic input to L-R sound card output
20 Hz to 20 kHz, 0 dB/-1.5 dB

L-R line input to L-R sound card output:
20 Hz to 20 kHz, +0 dB/-1.5 dB

L-R sound card input to L-R tape output:
20 Hz to 20 kHz +0 dB/-1.5 dB

L-R tape input to L-R monitor output
20 Hz to 20 kHz, +0 dB/-1.5 dB

Dimensions (H x W x D):

3.25" x 10.625" x 18.5"
(8.26 cm x 26.99 cm x 21.04 cm)

Weight:

8.2 lbs. (3.72 kg)

Power Requirements:

Dom: 120 VAC 60 Hz
Exp: 50 Watts nominal

Enabling StudioMix

In order to use the StudioMix hardware controller with your software, you must enable it. Follow this procedure to enable StudioMix with your Cakewalk product.

1. Select Tools | Global Options.
The Global Options dialog box appears.
2. In the General tab, check the Enable StudioMix Controller box.
3. Click OK.

The software now knows to configure itself to work with the StudioMix hardware. When this check box is enabled, MIDI Echo will be disabled on MIDI channel 16 and MIDI controller messages will not be recorded on that channel.

Dive in

After all of these setup details have been configured, you may see a Quick Start dialogue box that gives you a number of different ways to get started using Cakewalk. You can dive right in at this point, or begin by going through the online tutorials. If you are new to Cakewalk products, we recommend that you run through the online tutorials and multimedia Techniques. These will help introduce you to the software by real examples.

To access these tutorials, close the Quick Start dialog box (if it is open) and choose **Help Topics** from Cakewalk's **Help** menu. Click on the Contents tab and click on the **Getting Started** item then the **Tutorials** item in the list. This will open that section, and from here you can double-click on the Tutorials page to begin running the first tutorial.

If you get stuck or need help at any point when using StudioMix, remember that you have an extensive online help system that you can access by pressing F1 or choosing **Help Topics** from the **Tools** menu. Use the contents, index or find functions to get the information you need.

Templates

When creating your own projects, we have provided three templates to help you get started quickly. StudioMix templates each have eight tracks with pre-assigned tracks. There are three StudioMix templates, one with eight audio tracks, one with eight MIDI tracks, and one with four audio tracks and four MIDI tracks.

To Open a StudioMix template:

1. Select File | Open. The Open dialog box appears.
2. Select Cakewalk Template from the Files of Type drop down list.
3. Select one of the following:
 - StudioMix 4+4.tpl
 - StudioMix 8 Tracks Audio.tpl
 - StudioMix 8 Tracks MIDI.tpl
4. Click OK.

STUDIOMIX SPECIFICATIONS

Input Specifications:

Function	Input Z (ohms) Min.	Max. Gain	Input Levels			Bal./Unbal.	Connector
			Min.**	Nominal*	Max.		
Mic	2.2 k	47 dB	-47 dBu	-24 dBu	0 dBu	Bal.	XLR Pin 1 Ground Pin 2 (+) Pin 3 (-)
Line	10 k	14 dB	-14 dBu	0 dBu	+20 dBu	Bal.	RCA
Sound Card	10 k	15 dB	-15 dBu	0 dBu	+20 dBu	Bal.	RCA
Tape	10 k	15 dB	-15 dBu	0 dBu	+20 dBu	Bal.	RCA

0 dBu = 0.775V (RMS)

** Min. input level (Sensitivity) is the smallest signal that will produce nominal output (0 dBu) with level/gain control set for maximum gain.

* Nominal settings are defined as all controls set at 0 dB, or 50% rotation.

Output Specifications:

Function	Minimum Load Z (ohms)	Output Level		Bal./Unbal.	Connector
		Nominal	Max.		
Sound Card	1 k	0 dBu	+19 dBu	Unbal.	RCA
Tape	1 k	0 dBu	+19 dBu	Unbal.	RCA
Monitor	1 k	0 dBu	+19 dBu	Unbal.	RCA
Headphone	1 k	0 dBu (no load)	+16 dBu	Unbal.	1/8" TRS: Tip Left Ring Right, Sleeve Ground

0 dBu = 0.775V (RMS)

Frequency Response:

Mic input to L-R sound card output
20 Hz to 20 kHz, 0 dB/-1.5 dB

L-R line input to L-R sound card output:
20 Hz to 20 kHz, +0 dB/-1.5 dB

L-R sound card input to L-R tape output:
20 Hz to 20 kHz +0 dB/-1.5 dB

L-R tape input to L-R monitor output
20 Hz to 20 kHz, +0 dB/-1.5 dB

Dimensions (H x W x D):

3.25" x 10.625" x 18.5"
(8.26 cm x 26.99 cm x 21.04 cm)

Weight:

8.2 lbs. (3.72 kg)

Power Requirements:

Dom: 120 VAC 60 Hz

Exp: 50 Watts nominal

TWELVE TONE SYSTEMS, INC.
d/b/a CAKEWALK
LICENSE AGREEMENT

YOU SHOULD CAREFULLY READ ALL OF THE FOLLOWING TERMS AND CONDITIONS BEFORE USING THIS PRODUCT. INSTALLING AND USING THE PRODUCT INDICATES YOUR ACCEPTANCE OF THESE TERMS AND CONDITIONS. IF YOU DO NOT AGREE WITH THEM, YOU SHOULD PROMPTLY RETURN THE PRODUCT UNUSED AND YOUR MONEY WILL BE REFUNDED.

1. GRANT OF LICENSE. In consideration of payment of the license fee, Twelve Tone Systems, Inc., d/b/a Cakewalk ("Cakewalk" or the "Licensor") grants to you, the Licensee, a nonexclusive license to have one person use the enclosed Cakewalk software product (the "Product") on one personal computer at a time. If you want to use the Product on more than one personal computer at a time, or if you want to network the Product, you must obtain separate licenses from Cakewalk by calling (617) 441-7870. This license does not grant you any right to any enhancement or update to the Product. Enhancements and updates, if available, may be obtained by you at Cakewalk's then current standard pricing, terms and conditions.

2. OWNERSHIP OF THE PRODUCT. Portions of the Product incorporate certain material proprietary to third parties. Cakewalk and licensors of Cakewalk own and will retain all title, copyright, trademark and other proprietary rights in and to the Product. This License is NOT a sale of the Product or any copy of it. You, the Licensee, obtain only such rights as are provided in this Agreement. You understand and agree as follows:

- 2.1. You may NOT make any copies of all or any part of the Product except for archival copies of the computer software components of the Product as permitted by law.
- 2.2. You may NOT reverse compile, reverse assemble, reverse engineer, modify, incorporate in whole or in part in any other product or create derivative works based on all or any part of the Product.
- 2.3. You may NOT remove any copyright, trademark, proprietary rights, disclaimer or warning notice included on or embedded in any part of the Product.
- 2.4. You may NOT transfer the Product unless you permanently transfer the entire Product (including all components and archival copies, if any), and the person to whom the Product is transferred is informed of and agrees to the terms and conditions of this Agreement.
- 2.5. You may not use the documentation for any purpose other than to support your use of the SOFTWARE PRODUCT.
- 2.6. You may not perform engineering analysis of the SOFTWARE PRODUCT, including performance analysis, or benchmark analysis, without the written permission of Cakewalk.

3. CONTENT RESTRICTIONS. Unless specified elsewhere in your product package, the following restrictions apply to all digitally recorded sounds, MIDI or Cakewalk-format song files or rhythm patterns, and printed or digitally reproduced sheet music contained in the product package (the "content"):

All content is protected by copyright and owned by Cakewalk or other parties that have licensed these works to Cakewalk.

Any duplication, adaptation, or arrangement of the content without written consent of the owner is an infringement of U.S. or foreign copyright law and subject to the penalties and liabilities provided therein.

You may not synchronize the content with any videotape or film, or print the content in the form of standard music notation, without the express written permission of the copyright owner.

The content may not be used for broadcast or transmission of any kind.

You may not resell or redistribute the content "as is" (i.e., stand alone) in any way, including for use in sampling or sample playback units, or in any sound library product, or in any radio or television broadcast, soundtrack, film or other commercial product in any media, whether the works remain in their original form or are reformatted, mixed, filtered, re-synthesized or otherwise edited.

4. LICENSEE'S RESPONSIBILITIES FOR SELECTION AND USE OF THE PRODUCT. Cakewalk hopes the Product will be useful to your business or personal endeavors. HOWEVER, CAKEWALK DOES NOT WARRANT THE OPERATION OF THE PRODUCT OR THE ACCURACY OR COMPLETENESS OF ANY INFORMATION CONTAINED IN THE PRODUCT. You, and not Cakewalk, are responsible for all uses of the Product.

5. WARRANTY.

5.1. Limited Warranty. Subject to the other provisions in Articles 4 and 5 of this Agreement, Cakewalk warrants to you, the original licensee, that the media on which the Product is recorded will be free of defects in material and workmanship under normal use for a period of thirty (30) days from purchase, and that the Product will perform substantially in accordance with the user guide for a period of thirty (30) days from purchase. Cakewalk's sole responsibility under this warranty will be, at its option, (1) to use reasonable efforts to correct any defects that are reported to it within the foregoing warranty period or (2) to refund the full purchase price. Cakewalk does not warrant that the Product will be error free, nor that all program errors will be corrected. In addition, Cakewalk makes no warranties if the failure of the Product results from accident, abuse or misapplication. Outside the United States, these remedies are not available without proof of purchase from an authorized international source. All requests for warranty assistance shall be directed to Cakewalk at the following address:

Cakewalk
5 Cambridge Center
Cambridge, MA 02142 U.S.A.
617/441-7870

5.2. Limitations on Warranties. THE EXPRESS WARRANTY SET FORTH IN THIS ARTICLE 4 IS THE ONLY WARRANTY GIVEN BY CAKEWALK WITH RESPECT TO THE ENTIRE PRODUCT; CAKEWALK MAKES NO OTHER WARRANTIES, EXPRESS, IMPLIED OR ARISING BY CUSTOM OR TRADE USAGE, AND SPECIFICALLY DISCLAIMS THE IMPLIED WARRANTIES OF NON-INFRINGEMENT, MERCHANTABILITY OR FITNESS FOR ANY PARTICULAR PURPOSE. CAKEWALK SHALL NOT BE HELD RESPONSIBLE FOR THE PERFORMANCE OF THE PRODUCT NOR FOR ANY LIABILITY TO ANY OTHER PARTY ARISING OUT OF USE OF THE PRODUCT.

SOME STATES DO NOT ALLOW LIMITATIONS ON HOW LONG AN IMPLIED WARRANTY LASTS, SO THE ABOVE LIMITATION MAY NOT APPLY TO YOU. THIS WARRANTY GIVES YOU SPECIFIC LEGAL RIGHTS, AND YOU MAY ALSO HAVE OTHER RIGHTS WHICH VARY FROM STATE TO STATE.

6. LIMITATIONS ON REMEDIES. Cakewalk's liability in contract, tort or otherwise arising in connection with the Product shall not exceed the purchase price of the Product. IN NO EVENT SHALL CAKEWALK BE LIABLE FOR SPECIAL, INCIDENTAL, TORT OR CONSEQUENTIAL DAMAGES (INCLUDING ANY DAMAGES RESULTING FROM LOSS OF USE, LOSS OF DATA, LOSS OF PROFITS OR LOSS OF BUSINESS) ARISING OUT OF OR IN CONNECTION WITH THE PERFORMANCE OF THE PRODUCT, EVEN IF CAKEWALK HAS BEEN ADVISED OF THE POSSIBILITY OF SUCH DAMAGES.

SOME STATES DO NOT ALLOW THE EXCLUSION OR LIMITATION OF INCIDENTAL OR CONSEQUENTIAL DAMAGES SO THE ABOVE EXCLUSION OR LIMITATION MAY NOT APPLY TO YOU.

7. U.S. GOVERNMENT RESTRICTED RIGHTS. If you are a government agency, you acknowledge that the Product was developed at private expense and that the computer software component is provided to you subject to RESTRICTED RIGHTS. The rights of the government regarding its use, duplication,

reproduction or disclosure by the Government is subject to the restrictions set forth in subparagraph (c)(1)(ii) of the rights in Technical Data and Computer Software clause at DFARS 252.227-7013, and (c)(1) and (2) of the Commercial Computer Software -- Restricted Rights clause at FAR 52.227-19. Contractor is Twelve Tone Systems, Inc., d/b/a Cakewalk.

8. **TERMINATION.** This License Agreement will terminate immediately if you breach any of its terms. Upon termination, you will be required promptly to return to Cakewalk or to destroy all copies of the Product covered by this License Agreement.

9. **MISCELLANEOUS.**

9.1. **Governing Law.** The terms of this License shall be construed in accordance with the substantive laws of the United States and/or Commonwealth of Massachusetts, U.S.A.

9.2. **No Waiver.** The failure of either party to enforce any rights granted hereunder or to take any action against the other party in the event of any breach hereunder shall not be deemed a waiver by that party as to subsequent enforcement of rights or subsequent actions in the event of future breaches.

9.3. **Litigation Expenses.** If any action is brought by either party to this Agreement against the other party regarding the subject matter hereof, the prevailing party shall be entitled to recover, in addition to any other relief granted, reasonable attorneys' fees and litigation expenses.

9.4. **Unenforceable Terms.** Should any term of this License Agreement be declared void or unenforceable by any court of competent jurisdiction, such declaration shall have no effect on the remaining terms hereof.

9.5. **Certain components of this software are the property of Progressive Networks and its suppliers. You are not allowed to distribute these DLLs to others.**

YOU ACKNOWLEDGE THAT YOU HAVE READ THIS LICENSE AGREEMENT, UNDERSTAND IT AND AGREE TO BE BOUND BY ITS TERMS AND CONDITIONS. YOU FURTHER AGREE THAT IT IS THE COMPLETE AND EXCLUSIVE STATEMENT OF THE LICENSE AGREEMENT BETWEEN YOU AND CAKEWALK WHICH SUPERSEDES ANY PROPOSALS, OR PRIOR AGREEMENT, ORAL OR WRITTEN, AND ANY OTHER COMMUNICATIONS BETWEEN YOU AND CAKEWALK RELATING TO THE SUBJECT MATTER OF THIS LICENSE AGREEMENT.

IMPORTANT SAFETY INSTRUCTIONS

WARNING: When using electric products, basic cautions should always be followed, including the following:

1. Read these instructions.
2. Keep these instructions.
3. Heed all warnings.
4. Follow all instructions.
5. Do not use this apparatus near water. For example, near or in a bathtub, swimming pool, sink, wet basement, etc.
6. Clean only with a damp cloth.
7. Do not block any of the ventilation openings. Install in accordance with manufacturer's instructions. It should not be placed flat against a wall or placed in a built-in enclosure that will impede the flow of cooling air.
8. Do not install near any heat sources such as radiators, heat registers, stoves or other apparatus (including amplifiers) that produce heat.
9. Do not defeat the safety purpose of the polarized or grounding-type plug. A polarized plug has two blades with one wider than the other. A grounding type plug has two blades and a third grounding plug. The wide blade or third prong is provided for your safety. When the provided plug does not fit into your inlet, consult an electrician for replacement of the obsolete outlet. Never break off the grounding. Write for our free booklet "Shock Hazard and Grounding". Connect only to a power supply of the type marked on the unit adjacent to the power supply cord.
10. Protect the power cord from being walked on or pinched, particularly at plugs, convenience receptacles, and the point they exit from the apparatus.
11. Only use attachments/accessories provided by the manufacturer.
12. Use only with a cart, stand, tripod, bracket, or table specified by the manufacturer, or sold with the apparatus. When a cart is used, use caution when moving the cart/apparatus combination to avoid injury from tip-over.
13. Unplug this apparatus during lightning storms or when unused for long periods of time.
14. Refer all servicing to qualified service personnel. Servicing is required when the apparatus has been damaged in any way, such as power supply cord or plug is damaged, liquid has been spilled or objects have fallen into the apparatus, the apparatus has been exposed to rain or moisture, does not operate normally, or has been dropped.
15. If this product is to be mounted in an equipment rack, rear support should be provided.
16. Exposure to extremely high noise levels may cause a permanent hearing loss. Individuals vary considerably in susceptibility to noise-induced hearing loss, but nearly everyone will lose some hearing if exposed to sufficiently intense noise for a sufficient time. The U.S. Government's Occupational and Health Administration (OSHA) has specified the following permissible noise level exposures:

Duration Per Day In Hours	Sound Level dBA, Slow Response
8	90
6	92
4	95
3	97
2	100
1 1/2	102
1	105
1/2	110
1/4 or less	115

According to OSHA, any exposure in excess of the above permissible limits could result in some hearing loss. Ear plugs or protectors to the ear canals or over the ears must be worn when operating this amplification system in order to prevent a permanent hearing loss, if exposure is in excess of the limits as set forth above. To ensure against potentially dangerous exposure to high sound pressure levels, it is recommended that all persons exposed to equipment capable of producing high sound pressure levels such as this amplification system be protected by hearing protectors while this unit is in operation.

SAVE THESE INSTRUCTIONS!

PEAVEY ELECTRONICS CORPORATION LIMITED WARRANTY

Effective Date: July 1, 1998

What This Warranty Covers

Your Peavey Warranty covers defects in material and workmanship in Peavey products purchased and serviced in the U.S.A. and Canada.

What This Warranty Does Not Cover

The Warranty does not cover: (1) damage caused by accident, misuse, abuse, improper installation or operation, rental, product modification or neglect; (2) damage occurring during shipment; (3) damage caused by repair or service performed by persons not authorized by Peavey; (4) products on which the serial number has been altered, defaced or removed; (5) products not purchased from an Authorized Peavey Dealer.

Who This Warranty Protects

This Warranty protects only the original retail purchaser of the product.

How Long This Warranty Lasts

The Warranty begins on the date of purchase by the original retail purchaser. The duration of the Warranty is as follows:

Product Category	Duration
Guitars/Basses, Amplifiers, Pre-Amplifiers, Mixers, Electronic Crossovers and Equalizers	2 years *(+ 3 years)
Drums	2 years *(+ 1 year)
Enclosures	3 years *(+ 2 years)
Digital Effect Devices and Keyboard and MIDI Controllers	1 year *(+ 1 year)
Microphones	2 years
Speaker Components (incl. speakers, baskets, drivers, diaphragm replacement kits and passive crossovers) and all Accessories	1 year
Tubes and Meters	90 days

*[*denotes additional warranty period applicable if optional Warranty Registration Card is completed and returned to Peavey by original retail purchaser within 90 days of purchase.]*

What Peavey Will Do

We will repair or replace (at Peavey's discretion) products covered by warranty at no charge for labor or materials. If the product or component must be shipped to Peavey for warranty service, the consumer must pay initial shipping charges. If the repairs are covered by warranty, Peavey will pay the return shipping charges.

How To Get Warranty Service

(1) Take the defective item and your sales receipt or other proof of date of purchase to your Authorized Peavey Dealer or Authorized Peavey Service Center.

OR

(2) Ship the defective item, prepaid, to Peavey Electronics Corporation, International Service Center, 412 Highway 11 & 80 East, Meridian, MS 39301 or Peavey Canada Ltd., 95 Shields Court, Markham, Ontario, Canada L3R 9T5. Include a detailed description of the problem, together with a copy of your sales receipt or other proof of date of purchase as evidence of warranty coverage. Also provide a complete return address.

Limitation of Implied Warranties

ANY IMPLIED WARRANTIES, INCLUDING WARRANTIES OF MERCHANTABILITY AND FITNESS FOR A PARTICULAR PURPOSE, ARE LIMITED IN DURATION TO THE LENGTH OF THIS WARRANTY.

Some states do not allow limitations on how long an implied warranty lasts, so the above limitation may not apply to you.

Exclusions of Damages

PEAVEY'S LIABILITY FOR ANY DEFECTIVE PRODUCT IS LIMITED TO THE REPAIR OR REPLACEMENT OF THE PRODUCT, AT PEAVEY'S OPTION. IF WE ELECT TO REPLACE THE PRODUCT, THE REPLACEMENT MAY BE A RECONDITIONED UNIT. PEAVEY SHALL NOT BE LIABLE FOR DAMAGES BASED ON INCONVENIENCE, LOSS OF USE, LOST PROFITS, LOST SAVINGS, DAMAGE TO ANY OTHER EQUIPMENT OR OTHER ITEMS AT THE SITE OF USE, OR ANY OTHER DAMAGES WHETHER INCIDENTAL, CONSEQUENTIAL OR OTHERWISE, EVEN IF PEAVEY HAS BEEN ADVISED OF THE POSSIBILITY OF SUCH DAMAGES

Some states do not allow the exclusion or limitation of incidental or consequential damages, so the above limitation or exclusion may not apply to you.

This Warranty gives you specific legal rights, and you may also have other rights which vary from state to state.

If you have any questions about this warranty or service received or if you need assistance in locating an Authorized Service Center, please contact the Peavey International Service Center at (601) 483-5365 / Peavey Canada Ltd. at (905) 475-2578.

Features and specifications subject to change without notice.



Peavey Electronics Corporation • 711 A Street • Meridian, MS 39301
(601) 483-5365 • Fax (601) 486-1278 • www.peavey.com



80304594

©1999

Printed in U.S.A. 4/99