

EXPLANATION OF GRAPHIC SYMBOLS:



The lightning flash with the arrowhead symbol, within an equilateral triangle, is intended to alert the user to the presence of uninsulated "dangerous voltage" within the product's enclosure that may be of sufficient magnitude to constitute a risk of electric shock to persons.



The exclamation point within an equilateral triangle is intended to alert the user to the presence of important operating and maintenance (servicing) instructions in the literature accompanying the product.

IMPORTANT SAFETY AND INSTALLATION INSTRUCTIONS

INSTRUCTIONS PERTAINING TO THE RISK OF FIRE, ELECTRIC SHOCK, OR INJURY TO PERSONS

WARNING—When using electric products, basic precautions should always be followed, including the following:

1. Read all of the Safety and Installation Instructions and Explanation of Graphic Symbols before using the product.
2. Do not use this product near water—for example, near a bathtub, washbowl, kitchen sink, in a wet basement, or near a swimming pool, or the like.
3. This product, either alone or in combination with an amplifier and speakers or headphones, may be capable of producing sound levels that could cause permanent hearing loss. Do not operate for a long period of time at a high volume level or at a level that is uncomfortable. If you experience any hearing loss or ringing in the ears, you should consult an audiologist.
4. The product should be located so that its location or position does not interfere with its proper ventilation.
5. The product should be located away from heat sources such as radiators, heat registers, or other products that produce heat.
6. The product should be connected to a power supply only of the type described in the operating instructions or as marked on the product.
7. This product may be equipped with a polarized line plug (one blade wider than the other). This is a safety feature. If you are unable to insert the plug into the outlet, contact an electrician to replace your obsolete outlet. Do not defeat the safety purpose of the plug.
8. The power supply cord of the product should be unplugged from the outlet when left unused for a long period of time. When unplugging the power supply cord, do not pull on the cord, but grasp it by the plug.
9. Care should be taken so that objects do not fall and liquids are not spilled into the enclosure through openings.
10. The products should be serviced by qualified service personnel when:
 - A. The power supply cord or the plug has been damaged; or
 - B. Objects have fallen, or liquid has been spilled, into the product; or
 - C. The product has been exposed to rain; or
 - D. The product does not appear to be operating normally or exhibits a marked change in performance; or
 - E. The product has been dropped, or the enclosure damaged.
11. Do not attempt to service the product beyond that described in the user maintenance instructions. All other servicing should be referred to qualified service personnel.
12. **WARNING**—Do not place objects on the product's power supply cord, or place the product in a position where anyone could trip over, walk on, or roll anything over cords of any type. Do not allow the product to rest on or be installed over cords of any type. Improper installations of this type create the possibility of a fire hazard and/or personal injury.

SAVE THESE INSTRUCTIONS

ASSEMBLY INSTRUCTIONS

Step 1: With the leg standing on end align the two holes in the foot with the two pilot holes in the bottom of the leg. Use two M5 x 50mm wood screws to attach the foot to the leg. Repeat this for the other leg.

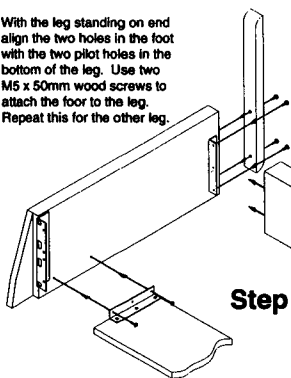

Step 2: With the leg still standing on end place the pedal crossmember, pedals up, onto the bracket near the foot. Put two M6 machine screws thru the bracket and into the threaded inserts on the underside of the pedal crossmember. Repeat this for the other leg.

Step 3: Align the bracket on the upper crossmember up with the two threaded inserts. When properly aligned the top edge of the upper crossmember should be approximately level with the top bracket. Put two M6 machine screws thru the bracket and into the threaded inserts in the leg. Repeat this for the other leg.

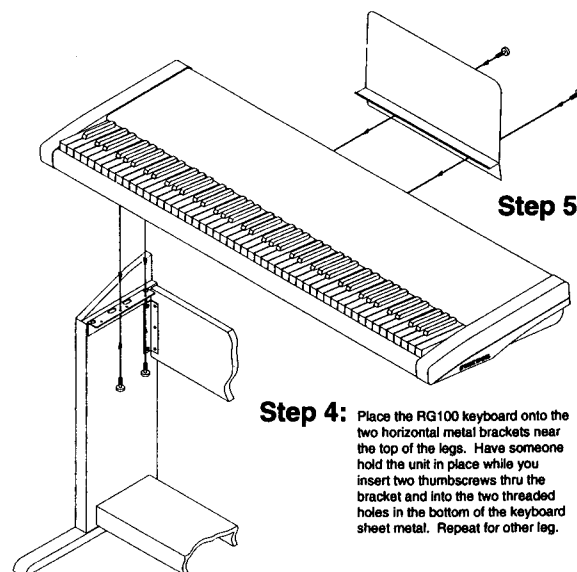

Step 4: Place the RG100 keyboard onto the two horizontal metal brackets near the top of the legs. Have someone hold the unit in place while you insert two thumbscrews thru the bracket and into the two threaded holes in the bottom of the keyboard sheet metal. Repeat for other leg.

Step 5: Align the two holes in the music rack up with the two threaded holes on the units rear panel. Insert a thumbscrew thru each hole.

RADIO AND TELEVISION INTERFERENCE

WARNING: Changes or modifications to this instrument not expressly approved by Young Chang could void your authority to operate the instrument.

Important: When connecting this product to accessories and/or other equipment use only high quality shielded cables.

Note: This instrument has been tested and found to comply with the limits for a Class B digital device, pursuant to Part 15 of the FCC Rules. These limits are designed to provide reasonable protection against harmful interference in a residential installation. This instrument generates, uses, and can radiate radio frequency energy and, if not installed and used in accordance with the instructions, may cause harmful interference to radio communications. However, there is no guarantee that interference will not occur in a particular

installation. If this instrument does cause harmful interference to radio or television reception, which can be determined by turning the instrument off and on, the user is encouraged to try to correct the interference by one or more of the following measures:

- Reorient or relocate the receiving antenna.
- Increase the separation between the instrument and the receiver.
- Connect the instrument into an outlet on a circuit different from the one to which the receiver is connected.
- If necessary consult your dealer or an experienced radio/television technician for additional suggestions.

Notice

This apparatus does not exceed the Class B limits for radio noise emissions from digital apparatus set out in the Radio Interference Regulations of the Canadian Department of Communications.

Avis

Le present appareil numerique n'emet pas de bruits radioelectriques depassant les limites applicables aux appareils numeriques de la class B prescrites dans le Reglement sur le brouillage radioelectrique edicte par le ministere des Communications du Canada.

YOUNG CHANG DISTRIBUTORS

Contact the nearest Young Chang office listed below to locate your local Young Chang/Kurzweil representative.

Young Chang Akki Co., Europe
Industriering 45
D-4060 Viersen 11
Germany
Tel: 011-49-2162-4491
Fax: 011-49-2162-41744

Young Chang Canada Corp.
130 Royal Crest Court
Markham Ontario L3R 0A1
Tel: (416) 513-6240
Fax: (416) 513-6252

Young Chang Akki
KangNam P.O.BOX 998
Seoul Korea
TEL : 001-82-2-3451-3500
FAX : 011-82-2-3451-3599

Young Chang America, Inc.
13336 Alondra Blvd.
Cerritos, CA 90701
Tel: (310) 926-3200
Fax: (310) 404-0748

INTRODUCTION TO THE
KURZWEIL™
Music Systems

RG100
Digital Piano

| | |
|----|--|
| 1 | Important Safety And Installation Instructions |
| | Assembly Instructions |
| 2 | Radio And Television Interference |
| | Young Chang Distributors |
| 4 | ABOUT THE RG100 |
| | Introduction |
| | Setting Up The Instrument |
| | Care Of Your Instrument |
| | Power |
| 5 | Demo |
| | The Keyboard And Pedals |
| | Sound Select |
| 6 | Digital Reverb & Effects |
| | Master Volume |
| | Reverb And Chorus |
| | Recorder |
| 7 | Function |
| | Demo |
| | Tuning |
| 8 | Keyboard Operations |
| | Transpose |
| | Velocity Sensitivity |
| | MIDI Channel |
| 9 | Additional Information |
| | Headphone Jack |
| | Rear Panel |
| | Power In |
| | Audio Out |
| | Audio In |
| | Pedals |
| | MIDI |
| 10 | Service |
| | Specifications |
| 11 | MUSIC |
| | Some Enchanted Evening |
| 14 | Bach Minuet |
| 16 | Eleanor Rigby |
| 18 | On Christ, The Solid Rock, I Stand |
| 19 | Sing |
| 22 | Can't Help Falling In Love |
| 24 | MIDI Implementation Chart |

**Table Of
Contents**



Kurzweil is a product line of
Young Chang Akki Co., Ltd.,
Seoul, Korea

Copyright © 1993 by HAL LEONARD PUBLISHING CORPORATION
International Copyright Secured All Rights Reserved

For all works contained herein:
Unauthorized copying, arranging, adapting, recording or public performance is an infringement of copyright.
Infringers are liable under the law.

ABOUT THE RG100

Introduction

Welcome to the Kurzweil **RG100**! The **RG100** gives you simple, affordable access to Kurzweil's high-quality sound technology. The authentic digital representations of musical instrument sounds in the **RG100** reproduce the finest details of the original sounds—from bass to treble and from soft to loud.

This manual serves as both a guided tour of the **RG100** for the new owner and a reference for later use. The features of the instrument are discussed one at a time, and the songs included give you an opportunity to play the **RG100** right away.

Setting Up The Instrument

See the "Important Safety And Installation Instructions" and "Assembly Instructions," on page 1, for information regarding the installation and assembly of the **RG100**.

Once the **RG100** is assembled and attached to its stand, make sure to plug the cord that comes from the pedals (in the base of the stand) into the Pedals jack, on the rear panel.

Four thumbscrews hold the keyboard to the stand. For table-top playing, unscrew these to detach the keyboard. CAUTION: Have someone hold the keyboard unit while you remove the thumbscrews, so that the unit does not fall. Also, unplug the cord from the Pedals jack, on the rear panel, before removing the keyboard from the stand.

Apply the four adhesive-backed rubber feet that were packed with the instrument to the bottom of the keyboard if you intend to place the instrument on anything other than its own stand.

NOTE: Make sure nothing obstructs the speakers. Don't cover them with anything.

CARE OF YOUR INSTRUMENT

Dust the **RG100** with a soft dry cloth; DO NOT use aerosol sprays on or near it. Clean the keys with a soft damp (NOT wet) cloth, dampened in a solution of dish soap and water if necessary. NEVER use solvents such as alcohol or benzene.

NOTE: To avoid possible injury or electrocution, do not open up the **RG100**. There are no user-serviceable parts inside.

POWER

The **RG100** operates on DC power; a DC power adaptor is included with the instrument to connect it to an AC outlet. If you should move to another country, or if you should have any doubts about AC voltages, see your local Kurzweil dealer.

Before connecting the power supply, make sure the Power switch, at the left end of the control panel, is OFF (0). One end of the power supply plugs into the Power In jack on the rear panel of the **RG100**; the other end plugs into an AC outlet.

Connect it to the instrument first, then the AC outlet; then turn the Power switch ON (I). The **RG100** is now ready to play. To make sure that you can hear the instrument, move the Master Volume slider to approximately the position shown:



This should provide a comfortable volume, which you can adjust if you wish.

Demo

The **RG100** contains a built-in demonstration to acquaint you with the sounds and capabilities it possesses. To access this demonstration, first press the Select button, in the Function section, which is located at the right end of the front-panel controls; the LED (light-emitting diode) above this button will illuminate. Then press the Play button, in the Recorder section, which has the word “Demo” printed beneath it. The LED above this button will also illuminate, the Function Select LED will go out, and the demonstration will begin playing.

The demonstration will stop automatically when it is finished. To stop it before it is finished, press the Play (Demo) button again. In either case, the LED above the Play (Demo) button will go out.

The keyboard of the **RG100** consists of 88 weighted keys, with an action designed to simulate the feel of an acoustic piano. Just as with an acoustic piano, the harder you press the keys of the **RG100** (more precisely, the faster you strike them), the louder and brighter the resulting sound is. In technical terms, this is called “velocity sensitivity.” It makes the **RG100** a truly expressive instrument. See page 8 for information on adjusting the velocity sensitivity to suit your preference. (NOTE: The Pipe Organ sound purposely *isn't* velocity-sensitive, because real pipe organs aren't velocity-sensitive.)

The Keyboard And Pedals

In addition to the expressiveness offered by the keyboard, there are two pedals that provide you with further control over the sounds of the **RG100**. These pedals have the same functions as those on a grand piano:

- **SUSTAIN.** Pressing the right pedal causes notes to sustain even when you lift your fingers from the keys.
- **SOFT.** Pressing the left pedal causes notes to sound softer and more muted when they are played.

NOTE: Pedals for electronic keyboards, which are essentially switches, come in two varieties: normally open and normally closed. Different manufacturers make one or the other of these two types. Your **RG100** automatically senses which kind of pedal is plugged into it when it is turned on, so it works perfectly with either type—if, for example, you should use the instrument apart from the stand and its built-in pedals, and decide to buy separate pedals. If you do so, we recommend the Kurzweil K-FP2 pedals. (Because the **RG100** senses the pedals on startup, make sure you do not step on either of the pedals when you turn on the instrument; if you do, that pedal will operate in reverse. To correct this, turn the **RG100** off, then back on.)

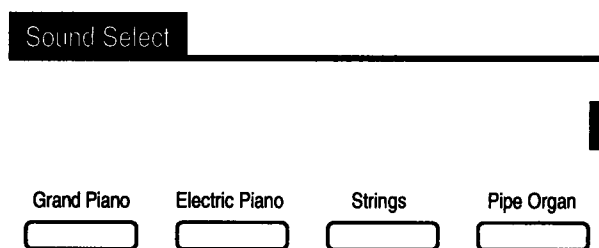

Sound Select

The Sound Select portion of the front panel contains buttons used for selecting from among the four different sounds available on the **RG100**. You select a sound by pressing the corresponding button. Any notes still sounding at the time you select a new sound will complete playing the original sound.

When you turn the Power switch ON, the Grand Piano sound is automatically active and ready to play.

Digital Reverb & Effects

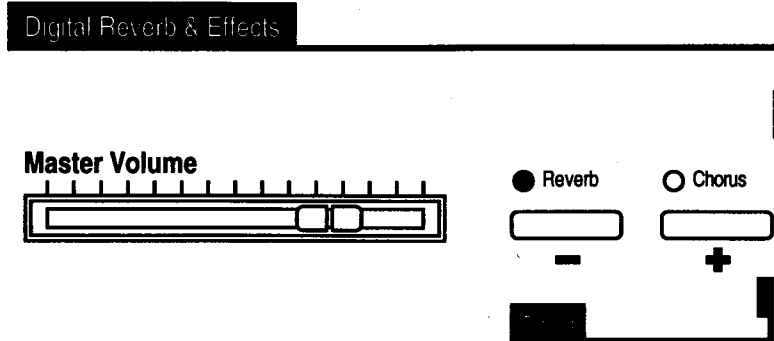

The Digital Reverb & Effects section of the panel contains controls that affect the sound of the **RG100**.

MASTER VOLUME

The Master Volume slider controls the overall volume (loudness) of the **RG100**. Move it to the right to increase the volume, and to the left to decrease the volume; when moved all the way to the left, it silences the instrument.

Master Volume affects not only the volume produced by the internal sound system, but also the volume produced by equipment connected to the Headphone or Audio Out jacks (see page 9). **CAUTION:** Turn the Master Volume down before connecting headphones or using the Audio Out jacks.

WARNING: Master Volume does not affect the signal that comes in through the Audio In jacks; this signal will play at full volume! If you wish to be able to control the level of the external device connected to these inputs, the device must have a volume control of its own.

REVERB AND CHORUS

For a heightened sense of sonic realism, the **RG100** provides you with two independent digital effects: Reverb and Chorus. Each is controlled by its own button; press the button to turn the effect ON (LED lit) or OFF (LED unlit).

Reverb, or reverberation, occurs naturally when sound undergoes multiple reflections off the walls of an enclosed space. These reflections blend together into a “wash” of sound that adds warmth and presence to music.

Chorus gives the effect of many instruments playing together instead of just one.

When you turn the **RG100** on, Reverb is ON and Chorus is OFF.

Recorder

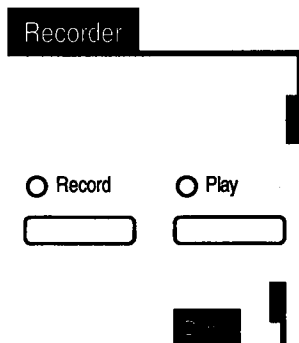

The Recorder lets you record and play back your performance on the **RG100**. Press Record; the red Record LED illuminates. The Recorder waits for you to start playing before it starts recording. It records notes, pedals, and button presses (except the Function Select button). (HINT: To record using a certain sound or effect, select the sound or effect *after* you press Record.) To stop recording, press Record again; the red LED goes out. If you reach the capacity of the Recorder (about 1,000 notes), recording stops automatically and the red LED goes out.

Press Play to play back your recording; the green Play LED illuminates and playback begins. You can play along with the recording. You can also use the pedals and change sounds and effects. (This will change the sound of the playback.) Playback stops automatically, and the green LED goes out, when you reach the end of the recording. If you wish to stop playback before the end, press Play again; playback stops and the green LED goes out.

Your recording remains in the memory of the **RG100** until you press Record again or until you turn the **RG100** off.

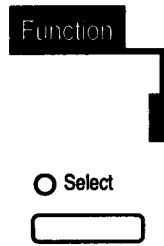

Function

The **RG100** has a special Function mode, from which you can do the following:

- listen to the built-in demonstration;
- tune the instrument;
- transpose the keyboard;
- adjust the velocity sensitivity of the keyboard;
- change the MIDI channel on which MIDI messages are transmitted and received.

Some of these functions are labeled on the control panel; others are accessed from the keyboard. In Function mode, the labels *beneath* buttons indicate what those buttons accomplish.

Press the Function Select button to enter Function mode; the LED above the button illuminates.

Setting the transpose, velocity sensitivity, or MIDI channel will cause the **RG100** to exit Function mode automatically. To exit Function mode after listening to the demo or tuning the instrument, press the Function Select button again; the LED above the button goes out and the **RG100** is returned to normal play mode.

Following is a description of the operations in Function mode.

Press the Play (Demo) button, in the Recorder section, to hear the built-in demonstration of the **RG100**; The LED will illuminate. Press the button again to stop the demo; the Play LED will go out. The Select LED will be out while playing.

DEMO

The **RG100** will never go out of tune. However, when playing with recordings or other musical instruments, you may desire to shift the tuning so that everything is playing at the same pitch. You can do so by as much as a quarter tone (half a half step) down or a quarter tone up.

TUNING

Press the Reverb (-) or Chorus (+) button to shift the tuning down or up, respectively. The first button press causes the Function Select LED to flash and the tuning to reset to standard concert pitch (A 440). Each subsequent button press lowers (-) or raises (+) the pitch by one *cent*—a hundredth of a half step—up to a maximum of 50 cents below or 50 cents above A 440.

While you are tuning, you can play the keyboard to hear the effect of the tuning change.

To return to A 440 pitch, turn the Function Select button off (to exit Function mode), then back on (to re-enter Function mode), and press one of the Tuning buttons once.

When you turn the **RG100** on, the tuning is always reset to A 440.

KEYBOARD OPERATIONS (see below)

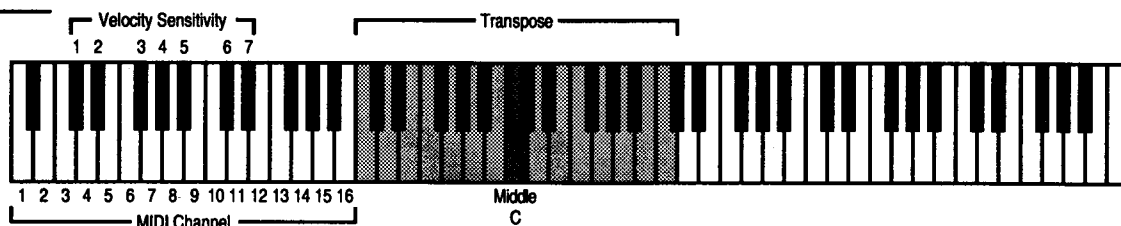

TRANPOSE

Transpose lets you play in one key and have the notes sound in another. This is useful when accompanying singers for whom the written music is too high or low, or when playing music written for a transposing instrument, such as a clarinet.

To change the transposition while in Function mode, strike a key on the keyboard within the octave above or the octave below Middle C. This keystroke (which does not sound a note) transposes the keyboard so that the Middle C key will now sound the note you selected, and the instrument will be transposed by the interval between Middle C and that note. (For example, to transpose up a fifth, strike G above Middle C.) The keystroke also causes the **RG100** to exit Function mode. The Function Select LED goes out, and the instrument is returned to normal play mode.

When the **RG100** is transposed, the transposition affects not only the sounds played from the keyboard, but also the note messages previously or subsequently recorded into the Recorder or sent to another instrument or sequencer via the MIDI Out port.

NOTE: The sounds in the **RG100** are designed to play over the full 88-note range of the keyboard. When the **RG100** is transposed, some keys at one end of the keyboard may be silent.

To return the **RG100** to no transposition, press the Function Select button (to re-enter Function Mode) and strike Middle C.

The **RG100** is reset to no transposition when power is turned on.

VELOCITY SENSITIVITY

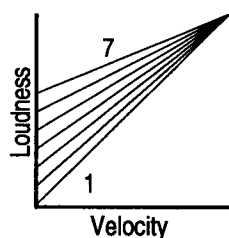

You can adjust the velocity sensitivity of the keyboard (how the dynamics of the sounds respond to key velocity) in Function mode by striking one of the seven keys that govern this setting. This keystroke (which does not sound a note), in addition to setting the velocity sensitivity of the keyboard, causes the **RG100** to exit Function mode. The Function Select LED goes out, and the instrument is returned to normal play mode.

A setting of 1 has the greatest dynamic range, but requires high velocities to obtain loud notes; a setting of 7 has a narrower range, but makes it easier to play moderately loudly (see the graph). For example, a child beginning piano lessons may benefit from a high setting, while an experienced player may prefer a lower setting.

When power to the **RG100** is turned on, the velocity sensitivity is set to 4.

MIDI CHANNEL

While the **RG100** is in Function mode, you can select the MIDI channel on which information is transmitted and received by striking one of the 16 keys that govern this setting. (See page 10 for more information about MIDI channels.)

The number of the key in the illustration corresponds to the number of the MIDI channel selected when that key is struck. This keystroke (which does not sound a note), in addition to setting the MIDI channel, causes the **RG100** to exit Function mode. The Function Select LED goes out, and the instrument is returned to normal play mode.

The MIDI channel is reset to 1 every time the **RG100** is turned on.

This section of the manual discusses three main areas: 1) Connections to the **RG100**; 2) Service; and 3) Specifications.

A 1/4" stereo headphone jack is located on the left front of the instrument, providing you with a means to play or practice at the **RG100** in privacy. Inserting a plug into the jack disables the internal speakers (although it does not disconnect the signal sent out the Audio Out jacks—see below).

The rear panel of the **RG100** is the location of connectors for such things as the DC power adaptor, audio outputs and inputs, pedals, and MIDI.

On the DC power adaptor is a plug that fits in the Power In receptacle on the rear panel; the other end of the adaptor plugs into a standard AC wall outlet.

Two RCA jacks provide audio output to external equipment, such as a home stereo, a PA system, or a tape recorder. They consist of a Left and a Right output for a complete stereo signal. They provide line-level signals.

Two RCA jacks accept line-level audio signals from external equipment, such as a tone module, a CD player, or a tape recorder. These inputs are directed to the Left and Right channels of the internal audio system.

These inputs are inserted after the digital reverb and effects; that is, the internal effects will not be applied to the signal from an external source.

WARNING: The signal that comes in through these jacks will play at full volume! These inputs are not affected by the Master Volume control of the **RG100**. If you wish to be able to control the level of the external device connected to these inputs, the device must have a volume control of its own.

The Pedals connector is where you plug in the cord from the pedals (located in the base of the stand). Without this connection, the **RG100** will not respond to the pedals.

“MIDI” stands for “Musical Instrument Digital Interface.” It is an international specification that allows electronic musical instruments to communicate with each other, using a simple cable connection. It ensures that the **RG100** will remain compatible with the instruments of today and tomorrow.

On the rear panel of the **RG100** are two five-pin MIDI ports:

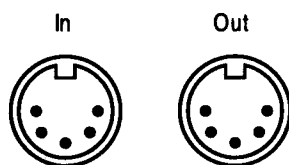

- In receives MIDI information from other equipment.
- Out sends MIDI information to other equipment.

Standard MIDI cables provide the connections between the MIDI ports of one piece of equipment and those of another.

Additional Information

HEADPHONE JACK

REAR PANEL

Power In

Audio Out

Audio In

Pedals

MIDI

The simplest use of MIDI is to play two instruments at a time from the keyboard of one of them. Use a MIDI cable to connect the MIDI Out port of the instrument whose keyboard you'll play (called the "master") to the MIDI In port of the other instrument (the "slave"). You probably will want to use the **RG100** as your master keyboard.

If the slave doesn't have built-in amplification and speakers, you can connect its audio outputs to the Audio In jacks on the **RG100**.

It is important to explain that what is sent over the MIDI cable is information (data), not sound. Each connected instrument produces its own sounds; this "layering" of different sounds is one of the benefits of MIDI. For the **RG100**, the information transmitted and received falls into four categories: playing notes, operating the pedals, selecting sounds, and turning Reverb and Chorus on or off.

Another application of MIDI is in using a *sequencer* to record and play back your performances. The sequencer can be a special hardware unit designed for that purpose, or it can be a personal computer running special sequencing software. In either case, the MIDI connections are the same—Out to In and In to Out.

A MIDI sequencer can control several instruments, each playing a different part, at the same time. To do this, it relies on MIDI *channels*. MIDI channels are like TV channels: an instrument has to be "tuned" to the correct one or it won't receive what is being transmitted. There are 16 channels available, numbered 1–16; the **RG100** can be set to any one of them. (Information on setting the MIDI channel of the **RG100** can be found on page 8.) The channel is set to 1 when the **RG100** is turned on.

Page 24 shows the complete MIDI Implementation Chart for the **RG100**.

SERVICE

The **RG100** contains no user-serviceable parts. In the event that you should experience a problem with the operation of the instrument, see your local Young Chang/Kurzweil dealer.

SPECIFICATIONS

Following are physical, audio, and power supply specifications for the **RG100**.

Physical

| | | |
|--------------------|---------|----------|
| ▪ Height: | 31" | (79 cm) |
| ▪ Depth: | 17.75" | (43 cm) |
| ▪ Length: | 51.75" | (131 cm) |
| ▪ Weight: | | |
| RG100 | 56 lbs. | (25 kg) |
| RGS (stand) | 43 lbs. | (20 kg) |
| TOTAL | 99 lbs. | (45 kg) |

Audio

| | |
|--------------------------|--|
| ▪ 20-Watt Amplification: | 2 x 10 Watts |
| ▪ 4 Speakers: | 2 x 4.5" (11 cm) woofers 2 x 2.5" (6 cm) tweeters |

Power Supply

| | |
|----------------------|-------------------------|
| ▪ AC Adaptor: | 13.5 Volts DC, 1.7 Amps |
| ▪ Power Consumption: | 1 Amp nominal |
| ▪ Model Number: | PP137-17 |

MIDI Implementation Chart

Manufacturer:
Young Chang

Version: 1.0

Model: Kurzweil RG100

Digital Piano

| Function | Transmitted | Recognized | Remarks |
|-------------------------|--|-----------------|------------------|
| Basic Channel | | | |
| Default | O | 1 | |
| Changed | O | 1-16 | |
| Mode | | | Always in Mode 3 |
| Default | X | X | |
| Messages | X | X | |
| Altered | X | X | |
| Note Number | | | key range: |
| True Voice | 0-127 12-108 | 0-127 12-108 | C0-C8 |
| Velocity | | | |
| Note ON | O | O | |
| Note OFF | O | O | |
| After Touch | | | |
| Keys | X | X | |
| Channel | X | X | |
| Pitch Bender | X | X | |
| Control Change | | | Sustain Pedal |
| 64 | O | O | Soft Pedal |
| 67 | O | O | Reverb Select* |
| 83 | O | O | |
| Program Change | | | 0-3 |
| True # | O 0-3 | O 0-3 | |
| System Exclusive | X | X | |
| System Common | | | |
| Song Pos | X | X | |
| Song Sel | X | X | |
| Tune | X | X | |
| System Real Time | | | |
| Clock | X | X | |
| Messages | X | X | |
| Aux Messages | | | |
| Local Control | X | X | |
| All Notes Off | X | X | |
| Active Sense | X | X | |
| Reset | X | X | |
| Notes | *Reverb Select: 0-31 = No Reverb 32-63 = Reverb Only 64-95 = Chorus Only 96-127 = Reverb and Chorus | | |

Mode 1: OMNI ON, POLY
Mode 3: OMNI OFF, POLY

Mode 2: OMNI ON, MONO
Mode 4: OMNI OFF, MONO

O = yes
X = no

