

KAWAI

K5000S
Advanced Additive Synthesizer

Owner's Manual



WARNING
TO REDUCE THE RISK OF
FIRE OR ELECTRIC
SHOCK, DO NOT EXPOSE
THIS PRODUCT TO RAIN

AVIS : RISQUE DE CHOC ELECTRIQUE - NE PAS OUVRIR.

TO REDUCE THE RISK OF ELECTRIC SHOCK, DO NOT REMOVE COVER (OR BACK).
NO USER-SERVICEABLE PARTS INSIDE. REFER SERVICING TO QUALIFIED SERVICE PERSONNEL.



The lightning flash with arrowhead symbol, within an equilateral triangle, is intended to alert the user to the presence of uninsulated "dangerous voltage" within the product's enclosure that may be of sufficient magnitude to constitute a risk of electric shock to persons.



The exclamation point within an equilateral triangle is intended to alert the user to the presence of important operating and maintenance (servicing) instructions in the literature accompanying the product.

CAUTION: TO PREVENT ELECTRIC SHOCK, MATCH WIDE BLADE OF PLUG TO WIDE SLOT, FULLY INSERT.
ATTENTION: POUR EVITER LES CHOCES ELECTRIQUES, INTRODUIRE LA LAME LA PLUS LARGE DE LA FICHE DANS LA BORNE CORRESPONDANTE DE LA PRISE ET POUSSER JUSQU'AU FOND.

This musical instrument is designed for household use, not commercial use.

FCC Information

This equipment has been tested and found to comply with the limits for a Class B digital device, pursuant to Part 15 of the FCC Rules. These limits are designed to provide reasonable protection against harmful interference in a residential installation. This equipment generates, uses and can radiate radio frequency energy and, if not installed and used in accordance with the instructions, may cause harmful interference to radio communications. However, there is no guarantee that interference will not occur in a particular installation.

If this equipment does cause harmful interference to radio or television reception, which can be determined by turning the equipment off and on, the user is encouraged to try to correct the interference by one or more of the following measures:

- Reorient or relocate the receiving antenna.
- Increase the separation between the equipment and the receiver.
- Connect the equipment into an outlet on a different electrical circuit from the receiver.
- Consult the dealer or an experienced radio/TV technician for help.

Canadian Radio Interference Regulations

This instrument complies with the limits for a class B digital apparatus, pursuant to the Radio Interference Regulations, C.R.C., c. 1374.

Important Safety Instructions

- * **Read Instructions** – This Owner’s Manual contains valuable information that will help you make full use of the instrument’s many capabilities. All the safety and operating instructions should be read before the product is operated.
- * **Retain Instructions** – The safety and operating instructions should be retained for future reference.
- * **Heed Warnings** – All warnings on the product and in the operating instructions should be adhered to.
- * **Follow Instructions** – All operating and use instructions should be followed.
- * **Water and Moisture** – The appliance should not be operated or stored near water or other moisture - for example, near a bath tub, wash bowl, kitchen sink, or laundry tub; in a wet basement; or near a swimming pool; and the like.
- * **Power Cord Protection** - Power-supply cords should be routed so that they are not likely to be walked on or pinched by items placed upon or against them, paying particular attention to cords at plugs, convenience receptacles, and the point where they exit from the product.
- * **Ventilation** – The appliance should be situated so that its location or position does not interfere with its proper ventilation. For example, the appliance should not be situated on a bed, sofa, rug, or similar surface that may block the ventilation openings; or similar surface that may block the ventilation openings; or placed in a built-in installation, such as a bookcase or cabinet that may impede the flow of air through the ventilation openings.
- * **Heat** – The appliance should be situated away from heat sources such as radiators, heat registers, stoves, or other appliances (including amplifiers) that produce heat.
- * **Noise** – Keep the appliance away from electrical motors, neon signs, fluorescent light fixtures, and other sources of electrical noise.
- * **Shocks** – Protect the appliance from physical shocks and impact. Never move it while it is in operation.
- * To reduce the risk of injury, close supervision is necessary when a product is used near a children.
- * Do not touch the power plug with wet hands. There is a risk of electrical shock. Treat the power cord with care as well. Stepping on or tripping over it can break or short-circuit the wire inside.
- * Do not place this product on an unstable or slant cart, stand, tripod, bracket, or table. The product may fall, causing serious injury to a child or adult, and serious damage to the product. Besides, the unit may malfunction. Use only with a cart, stand or table recommended by KAWAI, or sold with the product.
- * The appliance, in combination with an amplifier and speakers or headphones, may be capable of producing sound levels that could cause permanent hearing loss. Do not operate for a long period of time at a high volume level or at a level that is uncomfortable. If you experience any hearing loss or ringing in the ears, you should consult an audiologist.
- * This product may be equipped with a polarized line plug (one blade wider than the other). This is a safety feature. If you’re unable to insert the plug into the outlet, contact an electrician to replace your obsolete outlet. Do not defeat the safety purpose of the plug.
- * Always turn the power off when the appliance is not in use. The power supply cord of the product should be unplugged from the outlet when left unattended or unused for long period of time. Otherwise, fire or other hazards may be caused due to lightning and power-line surges, etc.
- * Care should be taken so that objects do not fall and liquids are not spilled into the enclosure through openings.

- * Unplug the appliance and power supply cord from the wall outlet immediately and refer servicing to qualified service personnel under the following conditions:
 - a) When the power-supply cord or plug is damaged.
 - b) If liquid has been spilled, or objects have been fallen into the product.
 - c) If the product has been exposed to rain or water.
 - d) If the product does not operate normally by following the operating instructions. Adjust only those controls that are covered by this manual as an improper adjustment of other controls may result in damage and will often require extensive work by a qualified technician to restore the product to its normal operation.
 - e) If the product has been dropped or damaged in any way.
 - f) When the product exhibits a distinct change in performance - this indicates a need for service.
- * Protect the product from direct sunlight, extremes in temperature (such as inside your car on a warm day) or humidity, dusty environment, or vibration (especially during transportation).
- * Always turn down the volume(s) of all instruments (such as guitar or keyboard) before connecting or disconnecting to the instrument.
- * Make sure that all POWER switches are off before changing equipment connections.
- * Check all equipment connections before applying the power.
- * Do not connect to the same circuit as a heavy load or equipment that generates line noise.
- * Unplug this product from the wall outlet before cleaning.
- * Do not use liquid cleaners or aerosol cleaners. Use a damp cloth for cleaning. (Clean the instrument with a soft cloth, a mild detergent, and lukewarm water.) Never use harsh or abrasive cleansers or organic solvents.
- * Servicing – The user should not attempt to service the appliance beyond that described in the operating instructions. All other servicing should be referred to qualified service personnel.
- * Do not disassemble or attempt to modify the appliance. Opening or removing covers may expose you to dangerous voltage.

CONTENTS

WELCOME TO THE K5000S	9
IF YOU NEED HELP..	10
ABOUT THE KEYBOARD'S INTERNAL MEMORY	10
ABOUT THE MEMORY EXPANSION KIT	10
K5000S FRONT PANEL	11
K5000S REAR PANEL	12
GUIDED TOUR	13
CONNECTIONS	14
PLAY THE DEMO	16
PLAYING THE DEMO	16
PLAYING SOUNDS	17
SINGLE SOUNDS	17
MULTI SOUNDS	18
PROGRAMMABLE ARPEGGIATOR	19
SINGLE SECTION	21
SINGLE PLAY	22
SINGLE EDIT	24
COMMON	25
DCO	30
DCO PITCH ENVELOPE	31
DCF	32
DCF (FILTER) ENVELOPE	33
DCA	35
ADDITIVE	37
HARMONIC LEVEL (DHL)	38
HARMONIC ENVELOPE (DHE)	41
FORMANT FILTER LEVEL (DFL)	44
FORMANT ENVELOPE (DFE)	47
MORF	50
LFO & COPY	51

REVERB TYPES	92
HALL 1	
HALL 2	
HALL 3	92
ROOM 1	
ROOM 2	
ROOM 3	93
PLATE 1	
PLATE 2	
PLATE 3	94
REVERSE	95
LONG DELAY	96
MULTI SECTION	97
MULTI PLAY	98
MULTI EDIT	100
COMMON	100
SECTION	101
WRITE	103
COMMON	105
SYSTEM SECTION	106
SYSTEM	106
FSW (PROGRAMMABLE SWITCHES)	107
ARPEGGIATOR	108
RESET	112
BACKUP	112
MIDI	113
DUMP	114
DISK SECTION	115
SAVE	115
LOAD	117
DELETE	118
FORMAT	119
FILE FORMAT LIST	119
QUICK MIDI	120
APPENDIX	123
SINGLE BANK SOUNDS	124
MULTI BANK SOUNDS	125
EFFECT PARAMETERS	126
PCM WAVE LIST	127

WELCOME TO THE K5000S

The K5000S is an Advanced Additive Synthesizer that combines realtime performance features and unique synthesis capabilities into a single unit.

ADVANCED ADDITIVE TONE GENERATOR

The K5000 series updates the famous K5 synthesizer tone generator and its unique additive harmonic synthesis approach. The Advanced Additive Tone Generator contains 32 source generators, which depending on how they are used, can yield up to 32 voice polyphony.

PCM samples can also be mixed with additive sources. As few as one or as many as six sources can be used to make a single sound. For example, a PCM wave of a piano hammer can be superimposed with the sound of the piano string created by additive harmonics.

128 BAND FORMANT FILTER

A new addition to the Advanced Additive tone generator is the 128 Band Formant Filter, which can be used as a Parametric EQ or several other configurations. The Formant Filter is completely controllable by envelopes or LFOs.

MACRO CONTROL

Unique to the K5000S model are the macro controls for major sound parameters, available on the front panel for instant access. In addition, four user controls are programmable for each patch.

PROGRAMMABLE ARPEGGIATOR

The K5000S Programmable Arpeggiator, features a wide range of control, ideal for use in Tekno and other modern musical styles.

DIGITAL EFFECTS SYSTEM

The K5000S contains an advanced digital effects processor (DSP), which allows four individual effects of chorus, delay, distortion, etc., in addition to reverb and a graphic equalizer.

When playing a single sound, individual *sources* can be routed to individual effects; when playing multiple sounds in Multi mode, individual *sounds* can be routed to individual effects.

IF YOU NEED HELP...

Please consult your local Kawai representative or contact the Kawai distributor in your country.

ABOUT THE KEYBOARD'S INTERNAL MEMORY

The contents of the keyboard's internal memory (such as tone data) and system data may be lost if you turn off the power while writing, saving or loading data.

Do not turn off the power while writing, saving or loading data.

If you have lost your system data, use the following procedure to reload the system data from the included SYSTEM DISK.

1. Insert the SYSTEM DISK into the disk drive.
2. Press the F2 button beside the LCD.
3. Turn the power on while holding down the F2 button. The installation will begin.
4. It will take about 8 minutes for the installation. You are now ready to use the K5000S.

NOTE:

* If you install this SYSTEM disk, the entire memory will be reset to factory preset setting and your own personalized data you created will be lost. You may not be able to back up the internal memory. So, we recommend that you save your important data on a floppy disk.

* It is not possible to copy this SYSTEM DISK. Retain the SYSTEM DISK with proper care.

* The contents of the keyboard's internal memory may be lost if you turn off the power while installing system data.

Do not turn off the power while installing system data.

If you lost system data, take the following procedure using the included SYSTEM DISK and load system data.

ABOUT THE MEMORY EXPANSION KIT

The K5000S MEMORY EXPANSION KIT may be available in your country. For more information, please consult your local Kawai representative or contact the Kawai distributor in your country.

K5000S FRONT PANEL

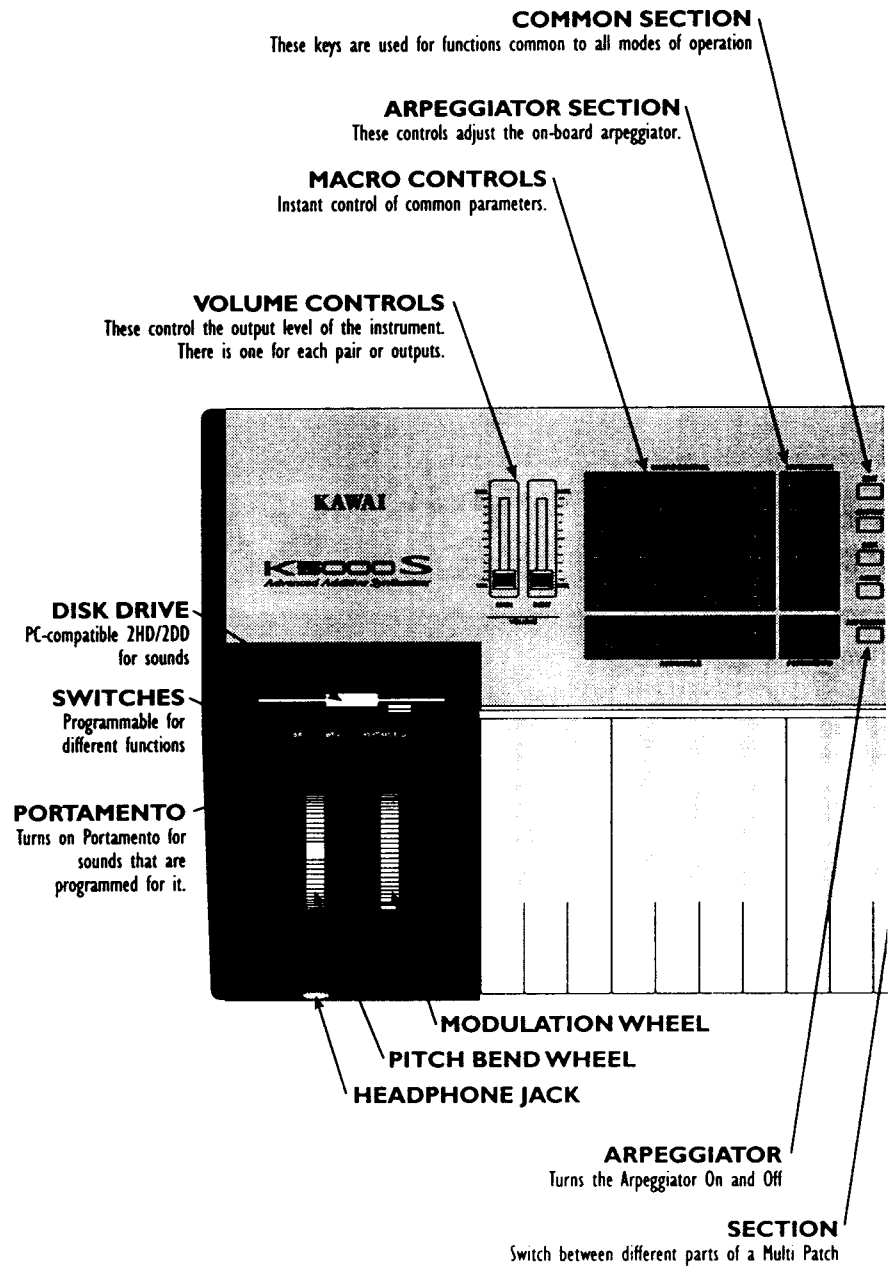

INTRODUCTION

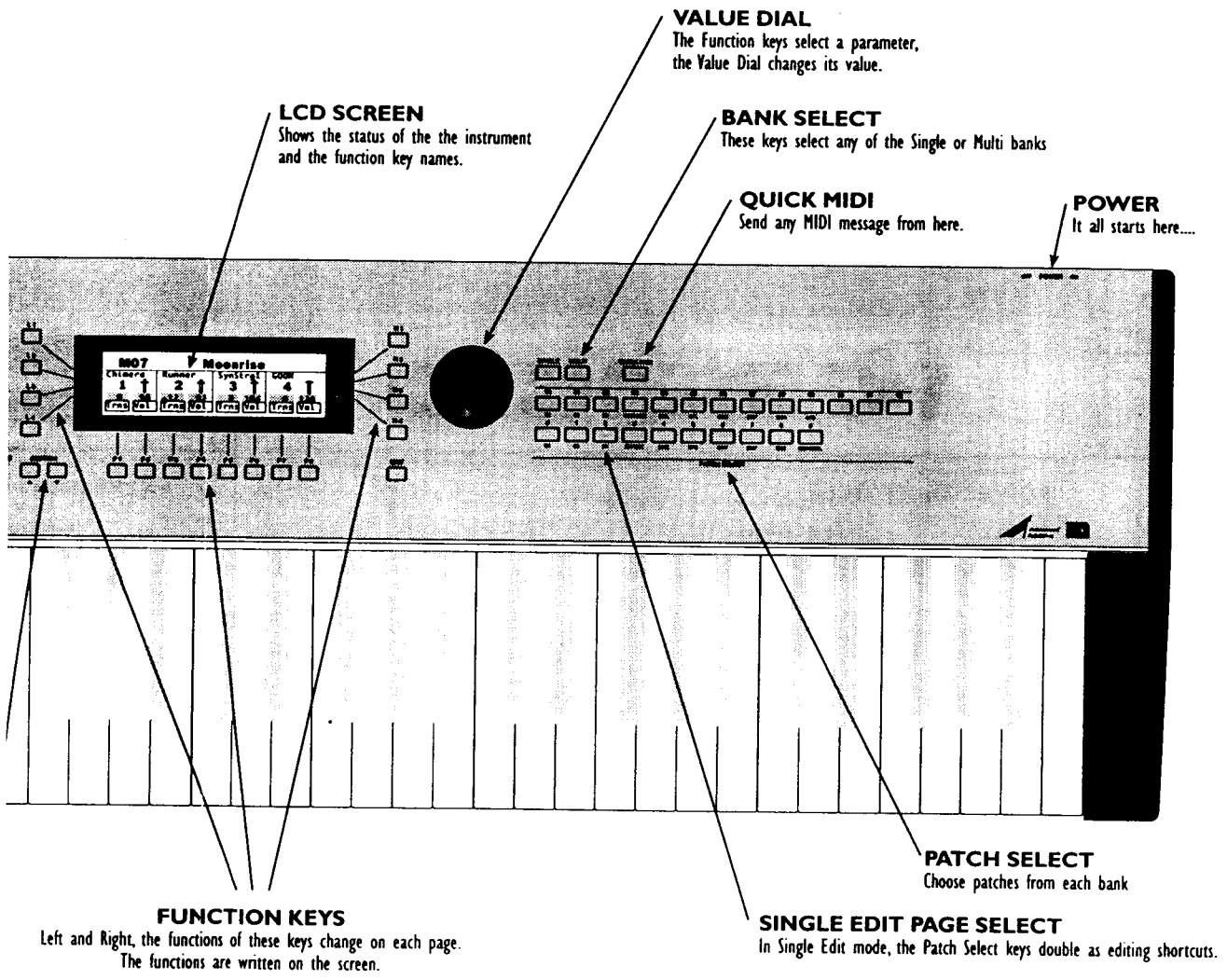

K5000S REAR PANEL

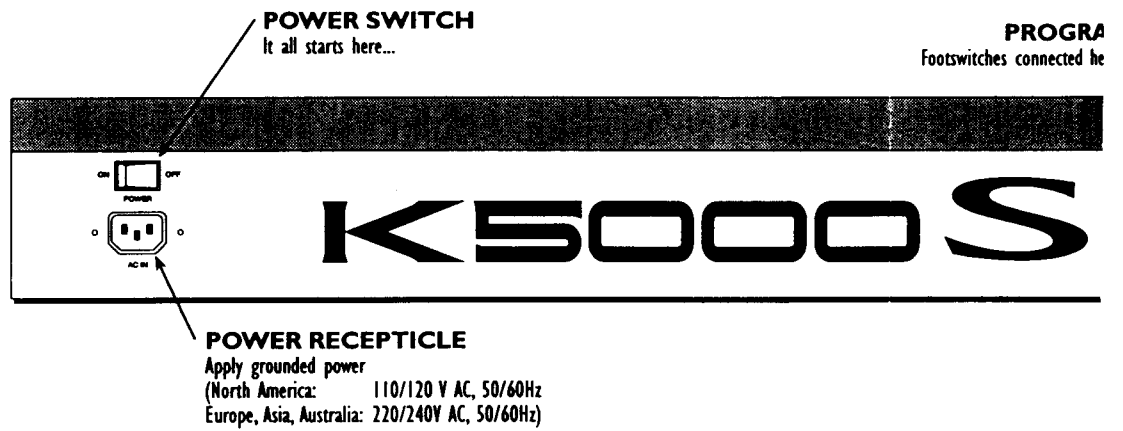

PROGRAMMABLE FOOTSWITCHES
These can be programmed for different functions.

MIDI IN/OUT/THRU
Connect your other MIDI devices here.

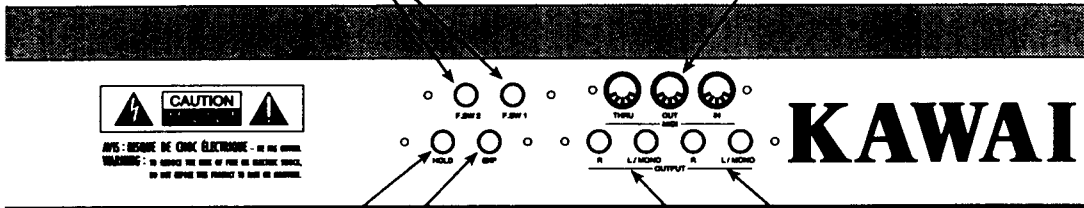

EXPRESSION PEDAL
Connect a volume pedal here
for expressive control.

HOLD PEDAL
Connect a sustain pedal here.

MAIN OUTPUTS
Mono or Stereo

INDIVIDUAL OUTPUTS
Mono or Stereo, individual sounds
can be routed to these outputs.
If not connected, these signals appear
at the Main Output.

GUIDED TOUR

CONNECTIONS

Naturally, the first thing you ought to do with your K5000S is plug it in!

POWER

Using the cable provided, connect the POWER jack to an AC outlet.

AUDIO

There are two pairs of audio output jacks on the back, plus the PHONES jack on the front (in front of the Pitch Bend wheel). This gives you a few choices, depending on what you're connecting to:

SOLO PLAY

Just plug your headphones into the PHONES jack on the front and go at it. There's plenty of power for phones. Use the MAIN volume slider to control the volume.

INSTRUMENT AMPLIFIER

If you are plugging into an amp, connect the MAIN L/MONO output jack on the rear panel to your amplifier. All sounds will be mixed to this single cable.

STEREO SYSTEM

To connect to a music system or amplified speakers, use the two MAIN outputs (L & R) to get stereo. You'll need adapters or adapting cable to convert the 1/4" Phone jacks on the K5000S to the RCA pin jacks on your stereo. Make sure to connect the K5000S to a LINE, AUX, or TAPE input on your stereo.

MIXING CONSOLE

If you've got more than two inputs available, by all means connect the two MAIN outputs *and* the two INDIVIDUAL outputs to your mixer. In this way, you can route certain sounds (piano, strings) through the reverb unit to the Main Outputs; and send others (bass drum, bass guitar) directly to the INDIVIDUAL outputs *without* reverb, or for special studio processing.

When connections are made to the INDIVIDUAL output jacks, the INDIVIDUAL volume slider on the front panel becomes active. You can adjust each pair of outputs independently.

PEDALS

HOLD

Connect a Hold pedal to the HOLD jack on the rear panel. Use a Momentary On footswitch, like the Kawai model F-1. This acts like a piano-style damper pedal, sustaining after releasing keys.

EXPRESSION

You can connect a Volume pedal (Kawai model V-20X) to the EXPRESSION jack on the rear panel.

PROGRAMMABLE FOOTSWITCHES

You can connect additional momentary footswitches, like the Kawai model F-1, to the Footswitch jacks as well. These can be programmed to do a range of things, such as change octave or turn the arpeggiator on and off.

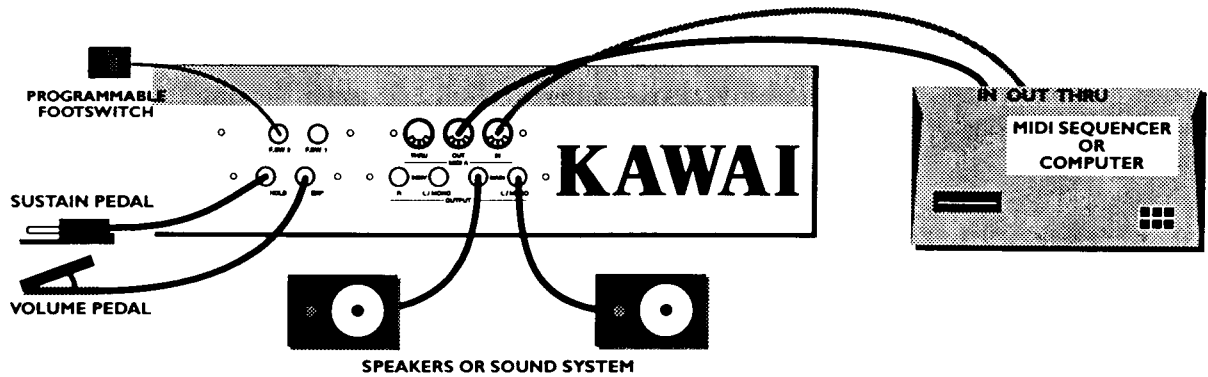

MIDI

There is a full set of MIDI ports on the rear panel of the K5000S: IN, OUT, and THRU jacks. You don't need to connect *any* of them, but if you want to talk to your other MIDI gear, here's how to connect them:

EXTERNAL KEYBOARD OR DRUM CONTROLLER

If you want to play the K5000S from another keyboard, MIDI drum or Guitar controller, connect it to the MIDI IN jack.

You will need to set the K5000S's Unit Channel to match the input jack and the MIDI channel the device transmits on. Press SYSTEM, then MIDI (F5), then Unit CH (L2).

SEQUENCER OR COMPUTER

If you want to use the K5000S with a sequencer or computer, you will need two cables. Connect the MIDI OUT of the K5000S to the MIDI IN of the computer, and the MIDI OUT of the computer to the MIDI IN of the K5000S

You will need to adjust the K5000S's Channels (in System of Multi) to match the sequencer. Depending on your configuration, you may also want to turn Local Control OFF - press SYSTEM, then MIDI (F5), then Local (L1).

ADDITIONAL SOUND MODULES

To use the K5000S to control other sound modules, connect a cable from the K5000S's MIDI OUT jack to the MIDI IN jack of the other device. If you have more than one device, you can loop from the MIDI THRU of the first device to the MIDI IN of the second.

PLAY THE DEMO

Now that everything is connected, lets see what the K5000S can do!

In the package with your K5000S is a demonstration diskette. Playing this will give a good picture of the K5000S's capabilities.

PLAYING THE DEMO

- With the Power OFF, insert the Supplement Disk into the disk drive on the left side of the instrument.
- Press and hold the F1 button, and while holding, turn on the power.
- The K5000S will startup, and a special Demo Play screen will appear.
[screen]
- Press F2 or F3 to select a song, then press F1 to Play the song.
- Press F1 again to stop.
- Press F2 or F3 to select a new song, or F4 to exit to the K5000S main screen.

PLAYING SOUNDS

Below is the K5000S Single Play screen. This screen appears after turning on the power.

A001				Runner			
USR1	Level	Pitch		ARP 	UP/DWN2		
USR2	LFO spd	Pitch		SW1	OctUp		
USR3	Vibrato	Pitch		SW2	OctDown		
USR4	Panpot	Pitch		FSW1	Arpeggio		
				FSW2	-----		

SINGLE SOUNDS

The K5000S contains two banks of Single sounds – A & D. Press the SINGLE button to switch between the two banks. Each bank is organized into groups of 10 patches.

There are up to 128 patches available in a bank, but the patch memory can be used up by fewer complex patches.

What happened to B & C? They are used on the companion unit – the K5000W.

CHOOSING A SINGLE SOUND

- If not already selected, choose the SINGLE bank, using the SINGLE button on the front panel.
- Choose a group: press one of the buttons labeled 00 – 12 on the front panel. A menu of the patches in the group appears on the screen.

Single Bank Menu			
A001 Runner	A005 Driver	A006 Reznator	
A002 Gorgizmo	A007 Goom	A008 Heaven	
A003 Dist Pulse	A009 Creaturz		
A004 Telmetal			

- Choose a patch: press one of the buttons labeled 0 – 9 on the front panel. The single patch appears on the screen.

A001				Runner			
USR1	Level	Pitch		ARP 	UP/DWN2		
USR2	LFO spd	Pitch		SW1	OctUp		
USR3	Vibrato	Pitch		SW2	OctDown		
USR4	Panpot	Pitch		FSW1	Arpeggio		
				FSW2	-----		

MODIFYING A SOUND

On the left side of the keyboard are 12 Macro Controls which can be used to instantly change the sound quality. In addition, there are four Assignable controls on the bottom row – User 1 through User 4. The screen explains the functions of these controls, as shown in the illustration above.

These do not change the preset values of the patch, which can only be changed by editing the patch – described starting on page 24.

MULTI SOUNDS

Multi Patches are *combinations* of up to four Single patches. They can be arranged in layers, key splits, velocity splits, channel splits, or any combination.

CHOOSING A MULTI

There are 64 Multi patches, M01 – M64.

- Choose the Multi bank: press the MULTI button on the front panel.
- Choose a group: press one of the buttons labeled 00 – 06 on the front panel. A menu of the patches in the group appears on the screen.

Multi Bank Menu			
M10	Komradds	M15	E-Normus
M11	Addalogg	M16	Raunch
M12	Addalog2	M17	TakeOver
M13	CashFlow	M18	Frostbyt
M14	WINBRASS	M19	Wilder

- Choose a patch: press one of the buttons labeled 0 – 9 on the front panel. An individual Multi patch appears on the screen.

M07 Moonrise							
Chimera	Runner	SynStrql	GOOM				
1 lch ↑	2 lch ↑	3 lch ↑	4 lch ↑				
Trns Vol	Trns Vol	Trns Vol	Trns Vol				

MODIFYING A MULTI

On the screen there are Transpose and Volume sliders for each Section, as shown in the illustration above. Push the button underneath the desired slider, then change the value with the VALUE dial. The slider image will also move according to your adjustment.

These do not change the preset values of the patch, which can only be changed by *editing* the Multi patch – described starting on page 100.

PROGRAMMABLE ARPEGGIATOR

The Programmable Arpeggiator offers a wide range of options to mix preset control with live performance. The following explanation only hints at what is possible...

- Press SYSTEM, then F2 (Arp) to reach the Arpeggiator Common Page.
- Set the controls as shown in the screen –
 Note (L1) = 48
 RangeLo (R1) = C -2
 Range Hi (R2) = C 3

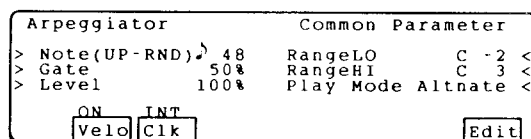

- Select Single Patch A006 (Reznator).

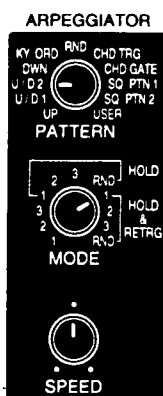
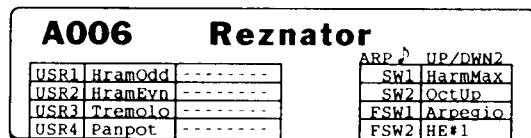

- Set the Arpeggiator Controls (left of the screen, next to the Macro Controls) as follows:

Pattern = U/D 2

Mode = Hold and Retrig 1

Speed = around 12 o'clock (straight up)

- Turn on the arpeggiator by pressing the ARPEGGIATOR button – it will light up red.

ARPEGGIATOR



- In the lower half of the keyboard, play a four note chord. The notes will arpeggiate. You can release the keys and the notes will still play.
- You can play a melody on top of this arpeggio with the right hand.

SINGLE SECTION

SINGLE PLAY

Pressing the SINGLE key on the right side of the keyboard brings up the Single Play window.

A001			Runner	
USR1	Level	Pitch	ARP \updownarrow	UP/DWN2
USR2	LFO spd	Pitch	SW1	OctUp
USR3	Vibrato	Pitch	SW2	OctDown
USR4	Panpot	Pitch	FSW1	Arpeggio
			FSW2	-----

The name of the patch is displayed, as well as the four user parameters and arpeggiator settings.

CHANGING SINGLE PATCHES

Single patches are arranged in 2 banks, A & D. To change banks, press SINGLE again. Each bank is arranged in groups of 10 patches. To select a different patch, use the Patch Select keys 0 through 9 on the right side of the panel. To change groups, use the Patch Select keys 00 through 12. A menu screen appears as shown below.

Single Bank Menu	
A001 Runner	A005 Driver
A002 Gorgizmo	A006 Reznator
A003 Dist Pulse	A007 Goom
A004 Telmetal	A008 Heaven
	A009 Creaturz

This screen lists the patches in the group. To select one press the 0-9 key corresponding to the last digit of the patch number. A different patch will play, with the display as shown at the top of this section.

NOTE:

In the Single Bank, there is not a fixed number of patches. Instead there is a fixed *amount of memory* for the patches. If your patches are simple, more of them can be stored. As a result, all patch locations may not be available.

MODIFYING PATCHES

In Single Play mode, the Macro Controls on the left of the instrument are available for instant edit. These controls are described below. They add and subtract from the original values contained in the patch, and affect all sources.

There are also four user controls which can be programmed as part of each patch. The programmed function is displayed on the main screen (USR1 – USR4).

A001			Runner	
USR1	Level	Pitch	ARP \updownarrow	UP/DWN2
USR2	LFO spd	Pitch	SW1	OctUp
USR3	Vibrato	Pitch	SW2	OctDown
USR4	Panpot	Pitch	FSW1	Arpeggio
			FSW2	-----

HRM LO

This control adjusts the level of the lower harmonics. This does not adjust the *low notes*, rather it adjusts the *low end* of any note.

HRM HI

This control adjusts the level of the upper harmonics. This does not adjust the *high notes*, rather it adjusts the *high end* of any note.

EVEN/ODD

This control adjusts the balance of even versus odd harmonics. A positive value boosts the even harmonics and cuts the odd ones, a negative value cuts the even harmonics and boosts the odd ones.

FF BIAS

This control adjusts the Formant Filter Bias, or center frequency.

FF SPEED

This control adjusts the speed of the LFO or Envelope controlling the Formant Filter.

FF DEPTH

Adjusts the Formant Filter LFO or Envelope Depth.

CUTOFF

This adjusts the filter cutoff frequency. Turn this up to make the sound brighter.

RESONANCE

This adjusts the filter resonance.

VELOCITY

Scales the velocity plus or minus. Use this control to adjust the way the patch responds to the dynamics of your playing.

ATTACK

This adjusts the envelope attack time for the DCA and DCF. Turn it down (minus value) to make the attack *sharper*, turn it up to make the attack *smoother*.

DECAY

This adjusts the initial decay for both the DCA and DCF envelopes. Turn it down (minus value) to make the decay *sharper*, turn it up to make the decay *smoother*.

RELEASE

This adjusts the release or final decay time for both the DCF and DCA envelopes. Turn it up to make the sound fade out longer *after* releasing the keyboard.

SELECTING A USER ARPEGGIATOR PATTERN

There are eight user arpeggiator patterns that can be stored in the K5000S.

TO SELECT A USER PATTERN:

- Turn the Arpeggiator Pattern control to USER.
- Turn the VALUE dial to select the desired user arpeggiator pattern.

For information about programming a pattern, see page 109

SINGLE EDIT

Pressing EDIT brings up the Edit Menu. All editing pages can be accessed from this page, with the knobs on the left, or by using the Patch Select buttons to the right of the screen – see the legends *underneath* the buttons.

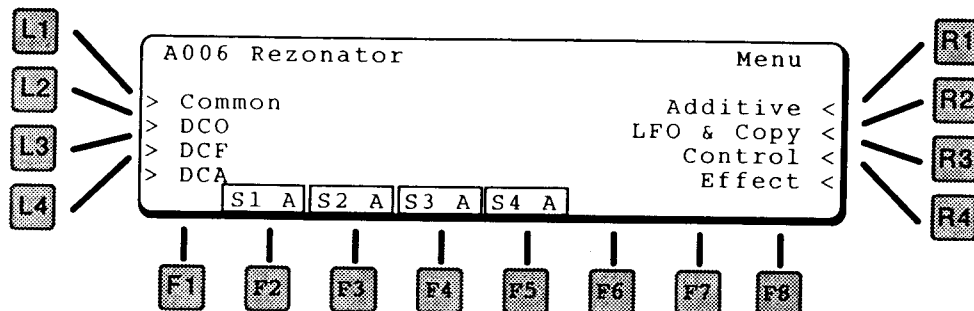

L1 COMMON
Jumps to the Common section, see page 25.

L2 DCO
Jumps to the DCO section, see page 30.

L3 DCF
Jumps to the DCF section, see page 32.

L4 DCA
Jumps to the DCA section, see page 35.

R1 ADDITIVE
Jumps to the ADD section, see page 37.

R2 LFO & COPY
Jumps to the LFO section, see page 51.

R3 CONTROL
Jumps to the Control section, see page 53.

R4 EFFECT
Jumps to the Effect section, see page 61.

NOTE:

Throughout the various pages of Single Edit mode, the F2 through F7 keys can be used to turn individual sound sources on or off.

EXITING EDIT MODE

Press EXIT to return to Play Mode. Depending on which page is displayed, you may need to press EXIT more than once. If you have made any changes to the patch, an alert message appears, asking if you want to "Save". Press WRITE to save, or **F8** (Quit) to exit without saving. To continue editing, press EDIT.

COMMON

The Common section contains several pages of basic parameters such as the patch name, below.

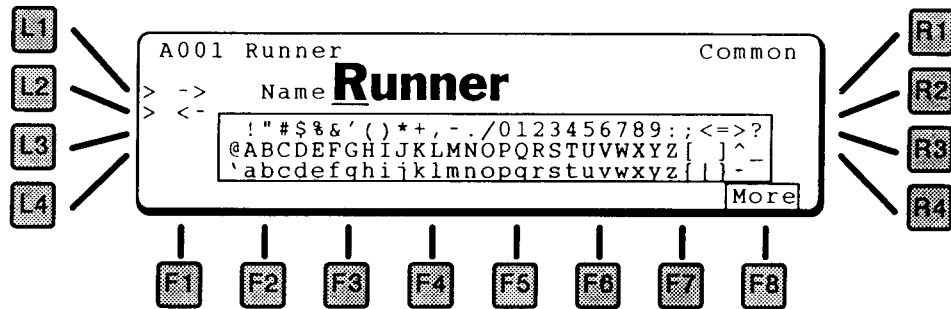

L1 and L2 move through the name forward and back, respectively. Use the Value dial to select a letter.

F8 MORE

Advances to the next page of Common parameters, below.

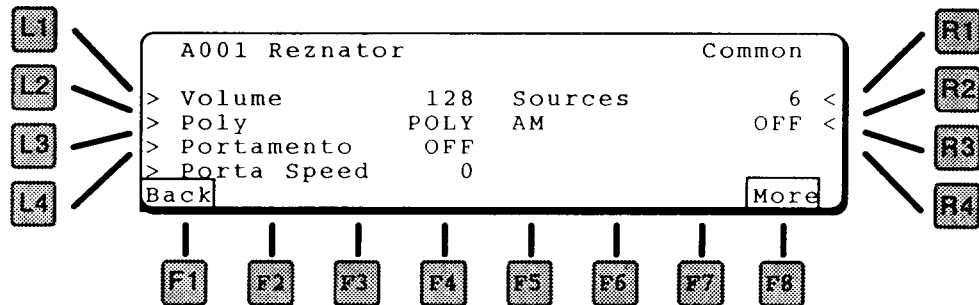

L1 VOLUME

Sets the master volume for the program.

L2 POLY

Sets the polyphonic mode for the patch.

POLY Standard polyphonic mode

SOLO1 Monophonic mode. Each key played re-triggers the envelopes.

SOLO2 Monophonic mode. Sustained keys played *do not* retrigger the envelopes.

L3 PORTAMENTO

This turns on Portamento for the patch. When ON, the sound will slide to each new pitch.

L4 PORTAMENTO SPEED

Sets the speed of the glide. The Portamento changes pitch at a constant rate – a larger interval takes longer than a shorter one.

R1 SOURCES

Sets the number of sources for the patch. Patches can have up to six sources. Remember that the more sources used in a patch, the fewer notes that can be played.

- R2 AM**
Selects sources for Amplitude Modulation. One source can be set to modulate an adjacent source, i.e., 1>2.
- F1 BACK**
Goes back to the previous Common page, above.
- F8 MORE**
Goes to the Macro and Switch Controller pages, below.

MACRO CONTROLLER

The next two pages control the functions of the four assignable user controls. Each control can manipulate two parameters.

Modulation Destinations are the same as those for the other controllers. See page 56 for a listing.

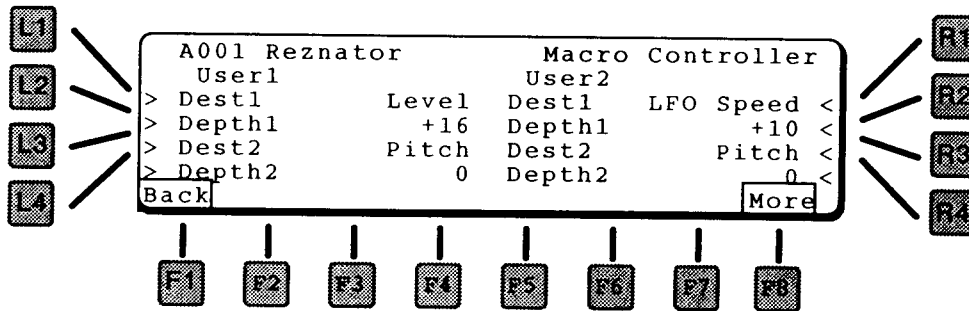

- L1 DEST1**
Selects one (of two) destinations for User Control 1.
- L2 DEPTH1**
Sets the amount of control for Destination 1.
- L3 DEST2**
Selects the other destination for User Control 1.
- L4 DEPTH2**
Sets the amount of control for Destination 2.
- R1 DEST1**
Selects one (of two) destinations for User Control 2.
- R2 DEPTH1**
Sets the amount of control for Destination 1.
- R3 DEST2**
Selects the other destination for User Control 2.
- R4 DEPTH2**
Sets the amount of control for Destination 2.
- F8 MORE**
Goes to User Controls 3 & 4.

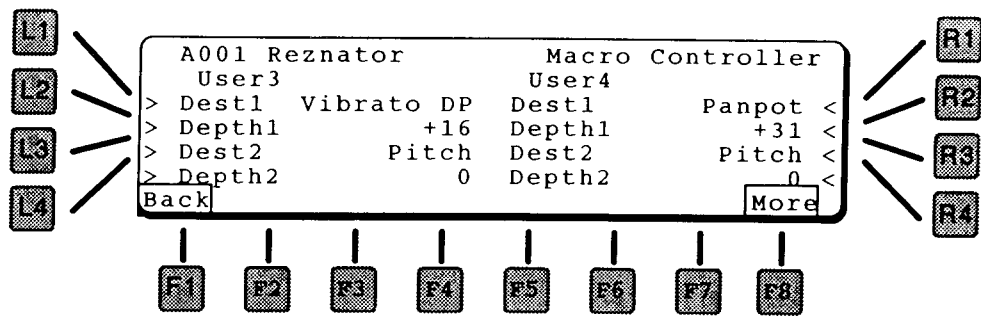

- L1 DEST1**
Selects one (of two) destinations for User Control 3.
- L2 DEPTH1**
Sets the amount of control for Destination 1.
- L3 DEST2**
Selects the other destination for User Control 3.
- L4 DEPTH2**
Sets the amount of control for Destination 2.
- R1 DEST1**
Selects one (of two) destinations for User Control 4.
- R2 DEPTH1**
Sets the amount of control for Destination 1.
- R3 DEST2**
Selects the other destination for User Control 4.
- R4 DEPTH2**
Sets the amount of control for Destination 2.
- F8 MORE**
Goes to the Switch Controller page, below.

SWITCH CONTROLLER

This page contains settings for the programmable buttons below the disk drive, and the programmable footswitch jacks on the rear panel.

NOTE:

The settings on this page take effect only if the Switches in the System page are set to Single – see page 107.

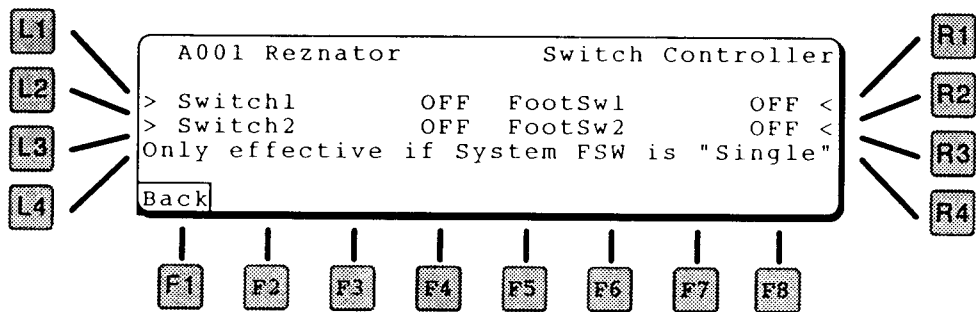

The switches can be set to any of the following functions:

OFF

Switch will have no effect.

HARM MAX

Sets all harmonics to maximum level.

HARM BRIGT

Sets all harmonics into a bright configuration (higher harmonics louder than lower harmonics).

HARM DARK

Sets harmonics into a dark configuration (first harmonic is set to maximum, other harmonics set to successively lower levels – sharp dropoff rate).

HARM SAW

Sets harmonics into a configuration that generates a Sawtooth wave (first harmonic is set to maximum, other harmonics set to successively lower levels – smooth dropoff rate).

SELECT LOUD

Switches the harmonics selection to Loud, regardless of the current setting.

ADD OCT

Adds the “Octave” harmonics – those tuned to octaves above the fundamental pitch: 2, 4, 8, 16, 32 – to the current harmonic series.

ADD 5TH

Adds the “fifth” harmonics – those tuned to a fifth above the fundamental pitch: 3, 6, 12, 24, 48 – to the current harmonic series.

ADD ODD

Adds the odd numbered harmonics – 3, 5, 7, etc. – to the current harmonic series.

ADD EVEN

Adds the even numbered harmonics – 2, 4, 6, etc. – to the current harmonic series.

HE#1

Switches the harmonic envelope rapidly between odd and even harmonics – however the first three harmonics stay on constantly.

HE#2

Sets the harmonic envelope to emphasize attack, and turns on feedback.

HE LOOP

Turns on harmonic envelope looping. See page 42.

FF MAX

Sets the formant filter frequency to maximum.

FF COMB1

Turns on the formant filter LFO at a slow rate.

FF HICUT

Sets the filter frequency low to cut out all the high frequencies.

FF COMB2

Turns on the formant filter LFO at a fast rate.

- L1 SWITCH1**
Selects the function for switch 1.
- L2 SWITCH2**
Selects the function for switch 2.
- R1 FOOTSW1**
Selects the function for footswitch 1.
- R2 FOOTSW2**
Selects the function for footswitch 2.

DCO

Pressing DCO in the Single Edit menu brings up the following screen which contains the DCO parameters.

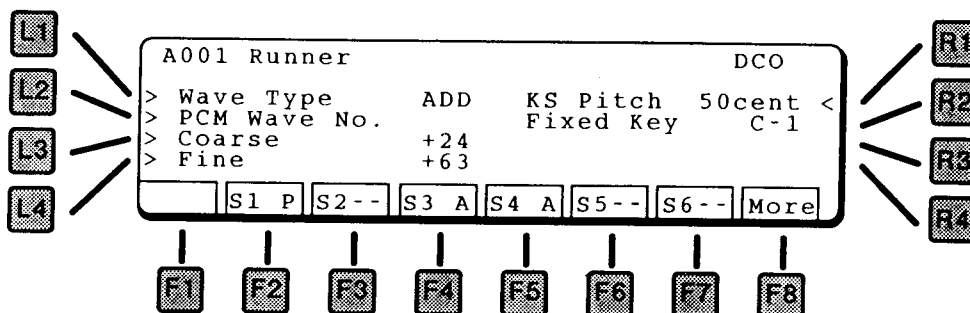

- L1 WAVE TYPE**
Selects the wave type for the source: ADD for the additive synthesizer, PCM for sample waves.
- L2 PCM WAVE NUMBER**
Selects the PCM wave to be used. See page 127 for a list of waves.
NOTE:
This has no effect if ADD is the selected wave type.
- L3 COARSE**
The coarse frequency in semitones. The range is two octaves above or below.
- L4 FINE**
The fine frequency setting. Use this for detuning the wave to create beating or fullness.
- R1 KS PITCH**
When the Fixed Key is being used (not Off, below) this parameter adds the key value to control the pitch. This can be used to play in quarter-tones, or to add "stretch" to the tuning. The reference point is the Fixed Key value.

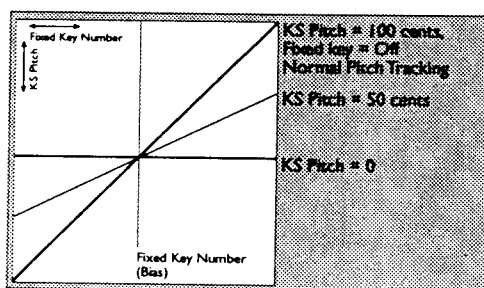

- R2 FIXED KEY**
Sets the fixed pitch for the source. The range is A-1 to C7. If Off, then normal key tracking applies.
- F8 MORE**
Goes to the DCO Pitch Envelope page, below.

DCO PITCH ENVELOPE

The DCO Pitch envelope changes the pitch of the sound over time. Many acoustic instruments have small pitch changes during their initial attack – pulling guitar strings and embouchure in wind instruments – which can be simulated using the DCO Pitch Envelope.

Because of its function during the attack phase of the sound, the DCO Pitch Envelope has only attack and decay functions – it does not sustain.

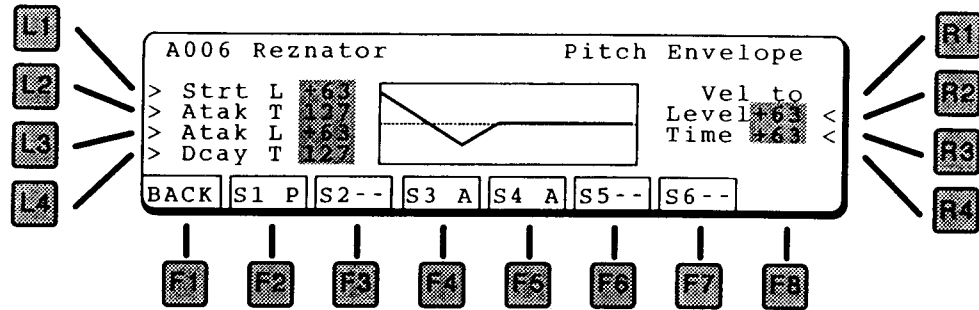

L1 STRT L (STARTING LEVEL)

Sets the starting level for the envelope.

L2 ATAK T (ATTACK TIME)

When a note is played (note on), the envelope will go from the starting level to the Attack Level in this amount of time.

L3 ATAK L (ATTACK LEVEL)

Sets the level after the initial attack.

L4 DECY T (DECAY TIME)

After reaching the attack level, the envelope will then go to zero in this amount of time.

R1 LEVEL (VELOCITY TO LEVEL)

This controls how much the key velocity affects the *amount* of pitch envelope.

R2 TIME (VELOCITY TO TIME)

This controls how much the key velocity affects the *overall time* of pitch envelope.

DCF

Pressing DCF in the Single Edit menu brings up the following screen which contains the DCF parameters.

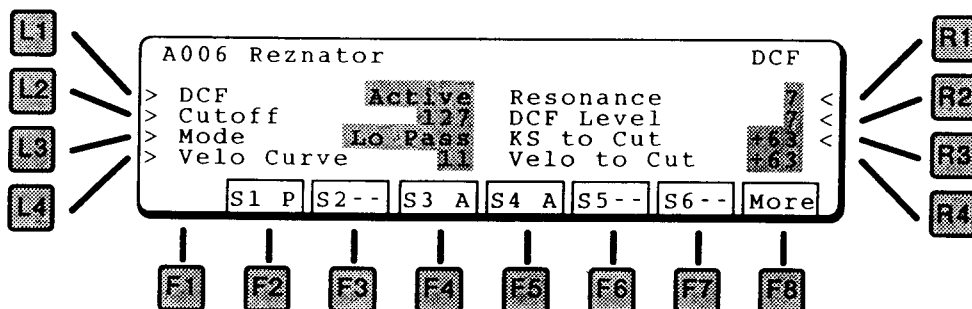

- L1 DCF**
This turns on the DCF. If Active, the signal is routed through the DCF. If set to Bypass, the sound does not pass through the DCF.
- L2 CUTOFF**
Sets the basic filter cutoff frequency.
- L3 MODE**
Sets the *type* of filter. The choices are:
 - Lo Pass Low Pass Filter – Cuts off the high frequencies (lets the low frequencies pass thru)
 - Hi Pass High Pass Filter – Cuts off the low frequencies (lets the high frequencies pass thru)
- L4 VELO CURVE**
Selects a velocity response curve. Works with Velo to Cut to tailor how the filter cutoff is affected by the key velocity.
- R1 RESONANCE**
Sets the amount of filter resonance. The higher the setting, the more *nasal* the sound.
- R2 DCF LEVEL**
Adjusts the input level to the filter.
- R3 KSTO CUT**
Controls how much the Key Scale affects the filter cutoff frequency.
- R4 VELOCITY TO CUT**
Controls how much the Velocity affects the filter cutoff frequency.
- F8 MORE**
Goes to the DCF Envelope page, below.

DCF (FILTER) ENVELOPE

This screen controls the envelope generator for the filter.

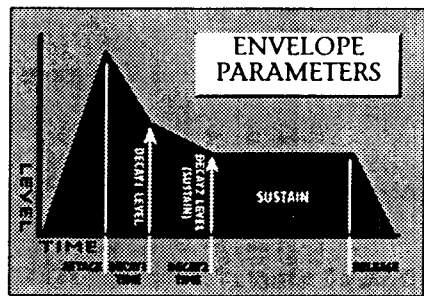
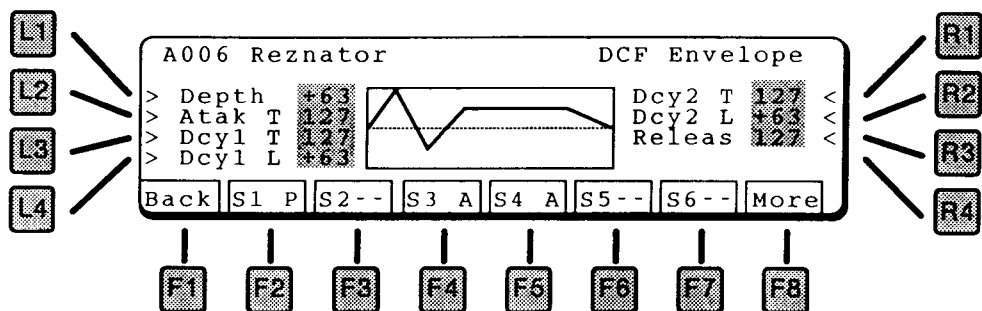

- L1 DEPTH**
Scales the strength of the entire envelope.
- L2 ATAK T (ATTACK TIME)**
When a note is played (note on), the envelope will go from zero to maximum in this amount of time. A short attack time gives a sharp edge to the start of the sound like a piano. A long attack gives a more legato effect.
- L3 DCY1 T (DECAY1 TIME)**
After reaching the maximum, the envelope will go to the decay1 level in this amount of time.
- L4 DCY1 L (DECAY1 LEVEL)**
After reaching the maximum, the envelope will go to this level.
- R1 DCY2 T (DECAY2 TIME)**
After reaching the decay1 level, the envelope will go to the decay2 level in this amount of time.
- R2 DCY2 L (DECAY2 LEVEL)**
The sustain level. After Attack, Decay1, and Decay2, if a note is still held on it will sustain at this level.
- R3 RELS T (RELEASE TIME)**
When a note is released (goes off) the envelope will return to zero in this amount of time.
- F8 MORE**
Goes to the next page of parameters, which modulate the envelope.

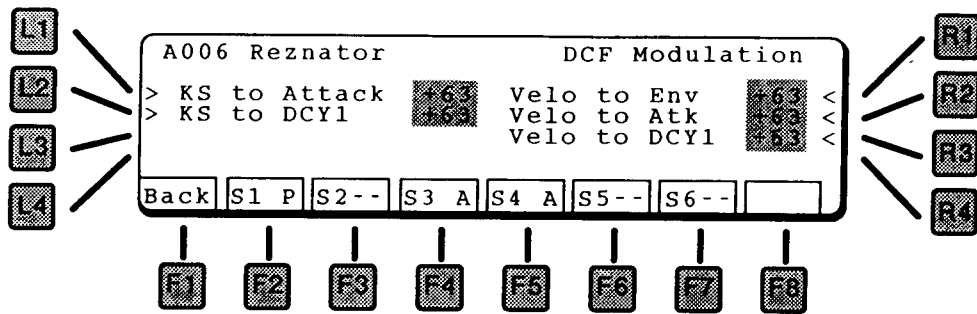

L1 KSTO ATTACK

Adds Key Scale to control the Attack time.

L2 KSTO DCY1

Adds Key Scale to control the Decay 1 time.

R1 VELO TO ENV

Adds Velocity to control the overall envelope level. The more velocity, the more the filter will open.

R2 VELO TO ATK

Adds Velocity to control the Attack time.

R3 VELO TO DCY1

Adds Velocity to control the Decay 1 time.

DCA

The Digitally Controlled Amplifier (DCA) sets the volume of the sound. It is controlled by an envelope to shape a sound's overall transient characteristics.

The DCA envelope screen shows a visual representation of the envelope.

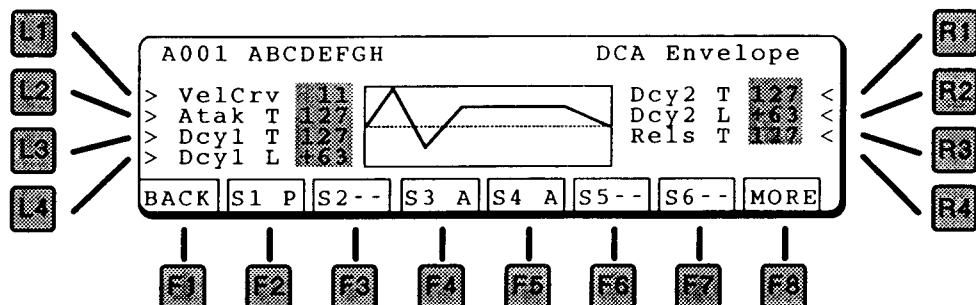

L1 VELOCITY CURVE

Selects a velocity response curve to tailor the response of the DCA to key velocity.

L2 ATTACK TIME

When a note is played (note on), the envelope will go from zero to maximum in this amount of time. A short attack time gives a sharp edge to the start of the sound like a piano. A long attack gives a more legato effect.

L3 DECAY1 TIME

After reaching the maximum, the envelope will go to the decay1 level in this amount of time.

L4 DECAY1 LEVEL

After reaching the maximum, the envelope will go to this level.

R1 DECAY2 TIME

After reaching the decay1 level, the envelope will go to the decay2 level in this amount of time.

R2 DECAY2 LEVEL

The sustain level. After Attack, Decay1, and Decay2, if a note is still held on it will sustain at this level.

R3 RELEASE TIME

When a note is released (goes off) the envelope will return to zero in this amount of time.

F8 MORE

Goes to the DCA Modulation page, below.

DCA MODULATION

This page offers parameters to modify the DCA envelope by key scale (which note is played) or velocity (how hard a key is played). Careful use of these parameters can add life and expression to any sound.

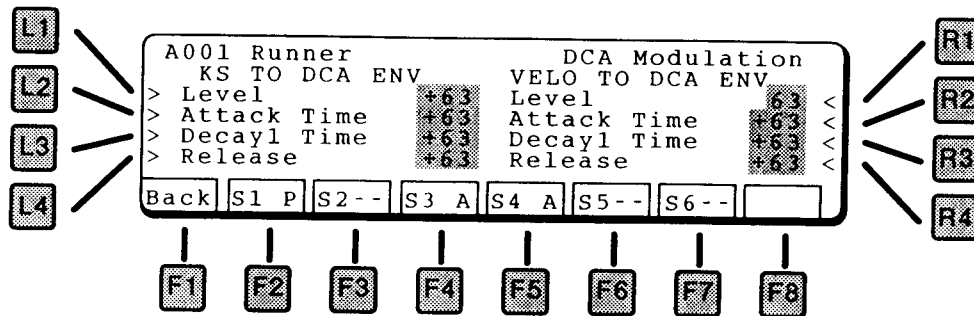

MODULATION BY KEY SCALE:

L1 ENVELOPE LEVEL

Uses key scale to control the maximum amount of the envelope. With a positive value, a higher key will have more envelope dynamics and a lower key will have less dynamics.

L2 ATTACK TIME

Uses key scale to control the attack time. With a positive value, a higher key will have a longer attack time and a lower key will have a shorter attack time.

In nature, lower instruments (baritone sax, for example) have a *longer* attack time than higher instruments (alto sax). Using *negative* amounts of this parameter will simulate this.

L3 DECAY1 TIME

Uses key scale to control the decay1 time. With a positive value, a higher key will have a longer decay time and a lower key will have a shorter time.

L4 RELEASE TIME

Uses key scale to control the decay1 time. With a positive value, a higher key will have a longer release time and a lower key will have a shorter time.

MODULATION BY VELOCITY:

R1 ENVELOPE LEVEL

Uses velocity to control the maximum amount of the envelope. With a positive value, a harder (louder) key will have more envelope dynamics and a softer key will have less dynamics.

R2 ATTACK TIME

Uses velocity to control the attack time. With a positive value, a harder (louder) key will have a longer attack time and a softer key will have a shorter attack time.

In nature, softer notes generally have a *longer* attack time than louder notes. Using *negative* amounts of this parameter will simulate this.

R3 DECAY1 TIME

Uses velocity to control the decay1 time. With a positive value, a harder (louder) key will have a longer decay time and a softer key will have a shorter time.

R4 RELEASE TIME

Uses attack velocity to control the release time. With a positive value, a faster key release will have a longer release time and a slower release will have a shorter time. Again, negative values of this parameter are more *natural*.

ADDITIVE

This section presents the editing parameters for Kawai's ADD harmonic synthesizer.

The first ADD screen presents seven submenus for navigation.

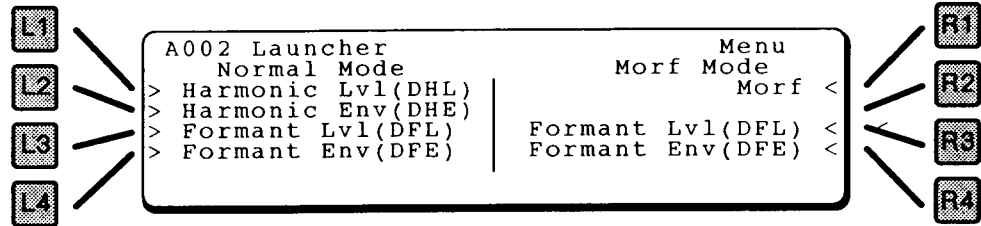

L1 HARMONIC LEVEL

Goes to DHL page, where the level of individual harmonics can be adjusted.

L2 HARMONIC ENVELOPE

Goes to DHE page, where the harmonics can be enveloped.

L3 FORMANT LEVEL

Goes to the DFL page, where the formant filter can be adjusted.

L4 FORMANT ENVELOPE

Goes to the DFE page, where the formant filter can be enveloped.

R1 MORF

Goes to the Morfing page, which is a harmonics programming assistant.

NORMAL VS MORF

There are two programming modes, Normal and Morf. Any additive source uses one or the other. The main difference is in how the Harmonic Envelopes are utilized. For this reason, if you change to Morf mode (by executing a morf), the DHE parameters are replaced by new Morf settings. Other sections are not affected.

R3 FORMANT LEVEL

Goes to the DFL page, where the formant filter can be adjusted.

R4 FORMANT ENVELOPE

Goes to the DFE page, where the formant filter can be enveloped.

HARMONIC LEVEL (DHL)

Selecting Harmonic Level from the previous page brings you to the DHL Menu page, where you can select pages for direct manipulation of the harmonic levels.

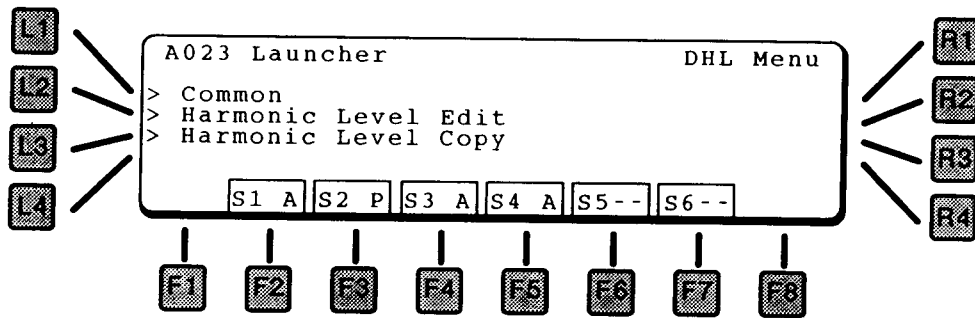

- L1 COMMON**
Edits parameters common to all harmonics.
- L2 HARMONIC LEVEL EDIT**
Goes to a visual display of harmonics, where individual harmonics can be adjusted.
- L3 HARMONIC LEVEL COPY**
Copies sets of harmonics from one patch to another.

COMMON

Edits parameters common to all harmonics.

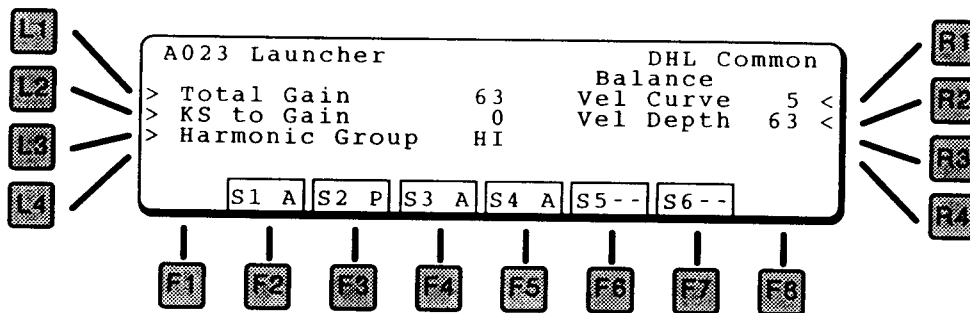

- L1 TOTAL GAIN**
This is the master level for this harmonic group.
- L2 KSTO GAIN**
This adjusts how much the Key Scale controls the gain of the harmonic group. With a positive value, high notes will have a higher gain than low notes.
- L3 HARMONIC GROUP**
In the K5000S, each source can use a harmonic bank of 64 harmonics. This parameter selects whether the first 64 harmonics (1 - 64, starting at the fundamental) or harmonics 65 - 128 are used.

By itself, the Hi harmonics group has a tonality similar to metallic percussion instruments.

R1 VELOCITY CURVE

12 velocity curves are available to adjust the response of the harmonic envelope to the touch of your playing. This curve is used for all sections of the patch. Curve #5 (below) equals an exact 1:1 correlation, the other curves weight the response in different directions.

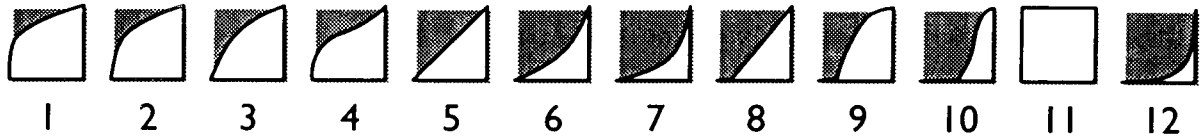

R2 VELOCITY DEPTH

This sets the velocity crossfade between the soft and loud harmonic groups.

HARMONIC LEVEL EDIT

Goes to a visual display of harmonics, where individual harmonics can be adjusted.

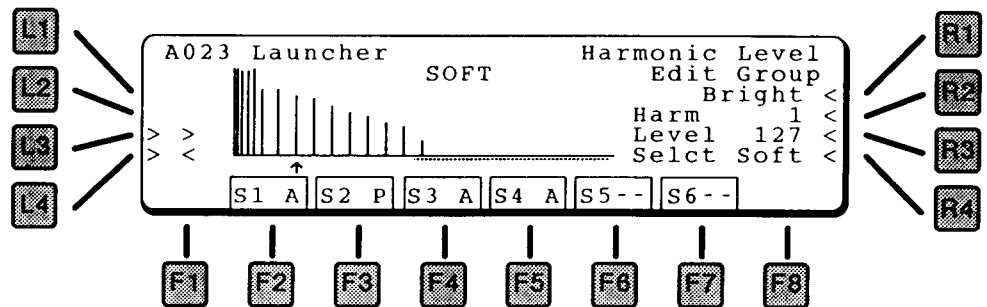

L3 NEXT HARMONIC

L4 PREVIOUS HARMONIC

These buttons select an individual harmonic. The small arrow under the harmonics displays which harmonic is selected, and its number and value can be seen on the right side of the screen (R2 and R3).

R1 EDIT GROUP

Since editing harmonics one at a time can become quite cumbersome, the Edit Group function allows you to select harmonics to modify as a group.

HARMONIC GROUPS

Harmonics can be grouped in the following categories. The dots underneath the harmonic bars show which harmonics are selected.

BRIGHT

The upper 32 harmonics.

DARK

The lower 32 harmonics.

ODD

The odd numbered harmonics.

EVEN

The even numbered harmonics.

OCT

Each harmonic tuned to an octave of the fundamental pitch: 1, 2, 4, 8, 16, 32, 64 (when lo is selected) / 128 (when hi is selected).

5TH

Each harmonic tuned to a fifth above of the fundamental pitch: 3, 6, 12, 24, 48 (when lo is selected) / 96 (when hi is selected).

ALL

All 64 harmonics.

EACH

Only the selected harmonic, the pointed to by the arrow under the harmonic display.

R2 HARMONIC NUMBER

Uses the Value dial to select a harmonic for display. The small arrow under the harmonics displays which harmonic is selected.

R3 LEVEL

Adjusts the level of the selected harmonic(s).

R4 SELECT

Selects a harmonic group to edit (soft or loud). These two sets can be crossfaded by velocity.

HARMONIC LEVEL COPY

From this screen, you can copy sets of harmonics from one patch to another. Since there are so many parameters in a harmonic series, this makes creating and modifying patches less time consuming.

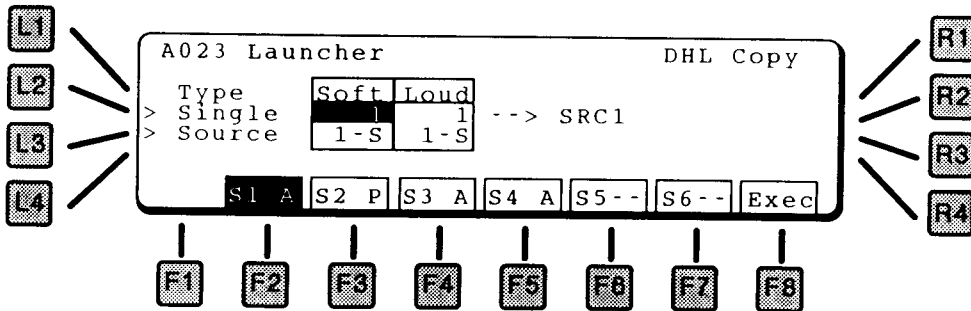

L2 SINGLE

Select the Patch to copy from. Pressing L2 switches between Soft and Loud.

L3 SOURCE

Select the Source from within the selected patch to copy from, 1 - 6. Pressing L3 switches between Soft and Loud variations.

*** = no copy. This means that this side (soft or loud) will not be copied.

F2~F7 DESTINATION

Press the F2-F7 buttons to select which source (of the current patch) that the copy will be made *to*.

F8 EXECUTE

Press this to make the copy.

HARMONIC ENVELOPE (DHE)

This screen is the menu for Harmonic Envelope functions.

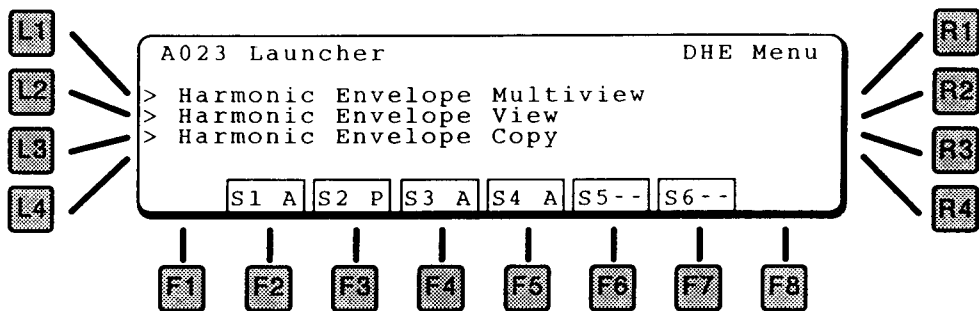

- L1 HARMONICS ENVELOPE MULTIVIEW**
Displays individual parameters for *all* 64 harmonic envelopes simultaneously.
- L2 HARMONICS ENVELOPE VIEW**
Displays all parameters of a *single* harmonic envelope.
- L3 HARMONICS ENVELOPE COPY**
Copies harmonic envelopes from a Single patch in memory to the current patch being edited.

HARMONIC ENVELOPE MULTIVIEW

The Harmonic Envelope Multiview screen shows individual segments of the harmonic envelope for all harmonics side by side. The display shows the rate on the left and the level on the right. The harmonics selected for editing are shown by the dots and the arrow underneath the graphs. Compare this screen to the Harmonic Envelope View screen (described on page 43), which shows all segments of a single envelope.

The harmonic envelope starts at zero. However the Attack phase can go above or below zero and the release does not have to end at zero, like a DCA envelope does.

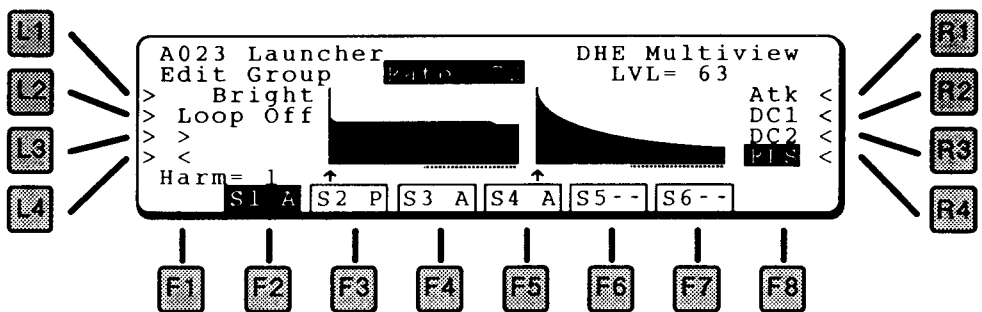

- L1 EDIT GROUP**
Since editing harmonics one at a time can become quite cumbersome, the Edit Group function allows you to select harmonics to modify *as a group*.

HARMONIC GROUPS

Harmonics can be grouped in the following categories. The dots underneath the harmonic bars show which harmonics are selected.

BRIGHT
The upper 32 harmonics.

DARK
The lower 32 harmonics.

ODD
The odd numbered harmonics.

EVEN
The even numbered harmonics.

OCT
Each harmonic tuned to an octave of the fundamental pitch: 1, 2, 4, 8, 16, 32, 64 (when lo is selected) / 128 (when hi is selected).

5TH
Each harmonic tuned to a fifth above of the fundamental pitch: 3, 6, 12, 24, 48 (when lo is selected) / 96 (when hi is selected).

ALL
All 64 harmonics.

EACH
Only the selected harmonic, the pointed to by the arrow under the harmonic display.

L2 LOOP

To enhance motion in the sound, the harmonic envelopes can loop among several settings during the sound's sustain.

OFF
No loop. Envelope goes to the Decay 2 Level and sustains there, the same as the envelopes for the DCF and DCA.

LPI
Loops between Decay 1 Level and Decay 2 Level, at the Decay 2 Rate.

LP2
Loops between Decay 1 Level and Decay 2 Level, but uses *both* Decay 1 and Decay 2 Rates.

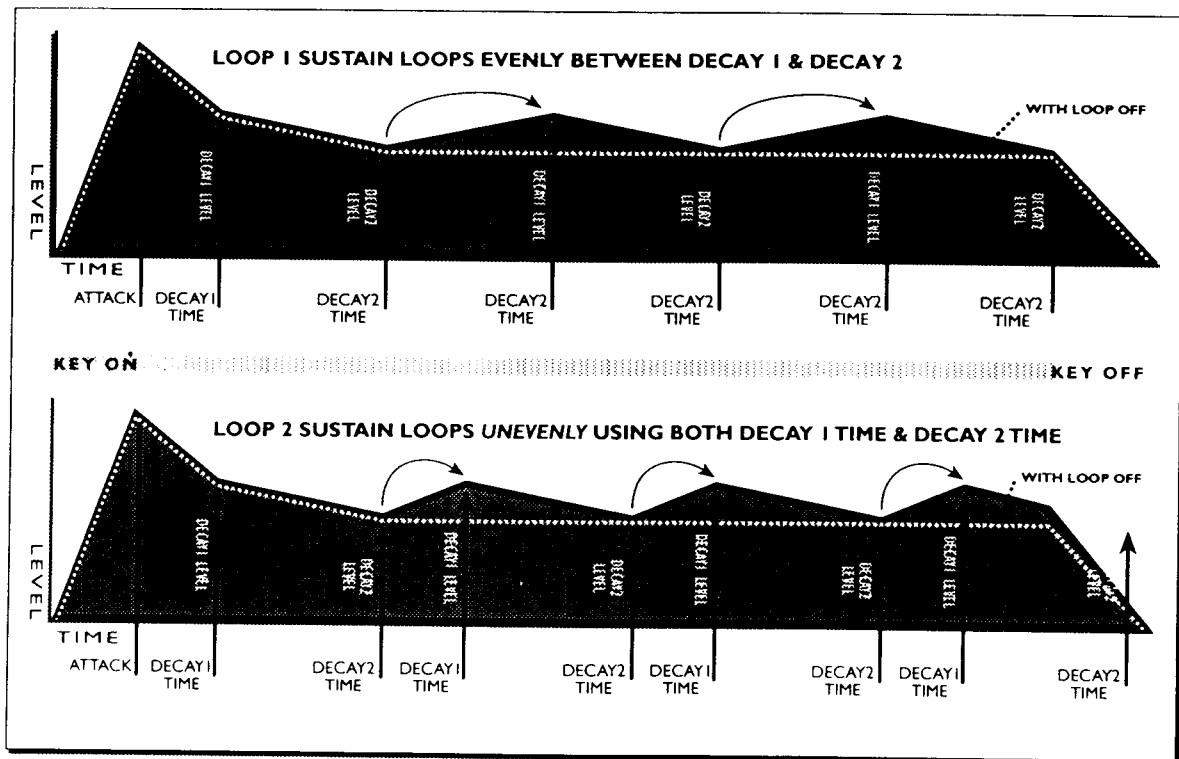

L3 NEXT HARMONIC

L4 PREVIOUS HARMONIC

These buttons select an individual harmonic. The small arrow under the harmonics displays which harmonic is selected.

R1 ATTACK (RATE & LEVEL)

Press R1 to switch between the Attack Rate and Attack Level. Use the Value dial to change the setting.

R2 DECAY 1 (RATE & LEVEL)

Press R2 to switch between the Decay 1 Rate and Level. Use the Value dial to change the setting.

R3 DECAY 2 (RATE & LEVEL)

Press R3 to switch between the Decay 2 Rate and Level. Use the Value dial to change the setting.

R4 RELEASE (RATE & LEVEL)

Press R4 to switch between the Release Rate and Level. Use the Value dial to change the setting.

HARMONIC ENVELOPE VIEW

This display shows all the envelope parameters for a single harmonic on one screen, another way of looking at the harmonic envelopes.

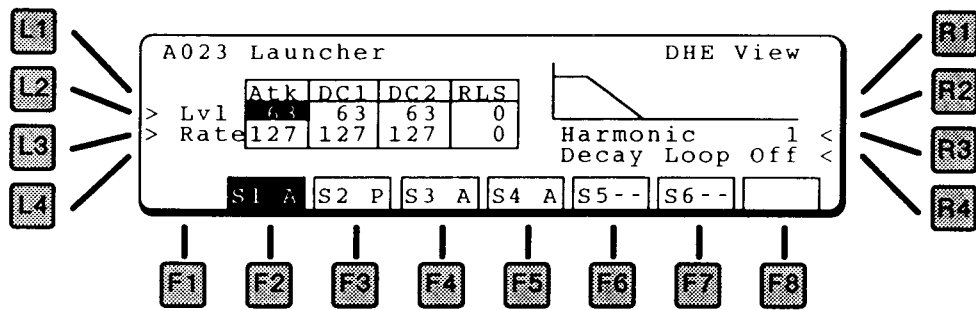

L2 LEVEL

Press L2 to cycle through the level settings for Attack, Decay 1, Decay 2, and Release. Use the Value dial to change the setting.

L3 RATE

Press L3 to cycle through the rate settings for Attack, Decay 1, Decay 2, and Release. Use the Value dial to change the setting.

R3 HARMONIC

This selects the harmonic to modify. Each of the 64 harmonics has its own envelope.

R4 DECAY LOOP

To enhance motion in the sound, the harmonic envelopes can loop among several settings during the sound's sustain. See the diagram on the previous page.

OFF

No loop. Envelope goes to the Decay 2 Level and sustains there, the same as the envelopes for the DCF and DCA.

LPI

Loops between Decay 1 Level and Decay 2 Level, at the Decay 2 Rate.

LP2

Loops between Decay 1 Level and Decay 2 Level, but uses *both* Decay 1 and Decay 2 Rates.

HARMONIC ENVELOPE COPY

From this screen, you can copy sets of harmonic envelopes from one patch into the current patch. Since there are so many parameters in a harmonic envelope, this makes creating and modifying patches less time consuming.

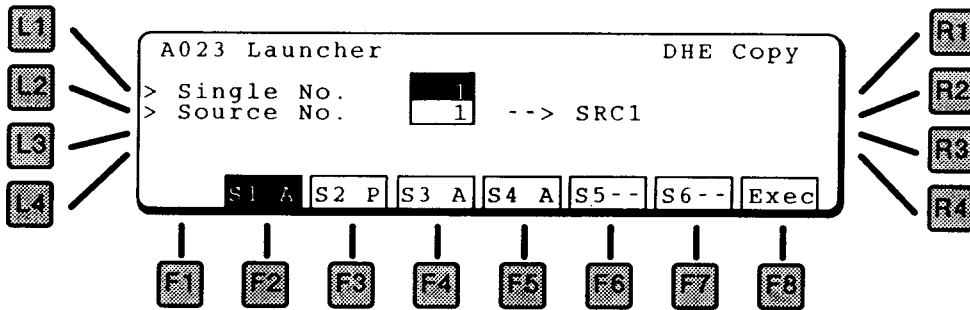

L1 SINGLE NUMBER

This sets the patch to copy the harmonic envelope *from*.

L2 SOURCE NUMBER

This sets the source from the Single patch (selected above) to copy from.

F2 – F7 DESTINATION SOURCE

Press the Source function key to select which source the envelope will be copied *to*. The display shows the destination as --> SRC#.

F8 EXECUTE

Press this to make the copy.

FORMANT FILTER LEVEL (DFL)

The K5000's Formant Filter is a 128-band graphic equalizer, which can be used to create additional additive effects.

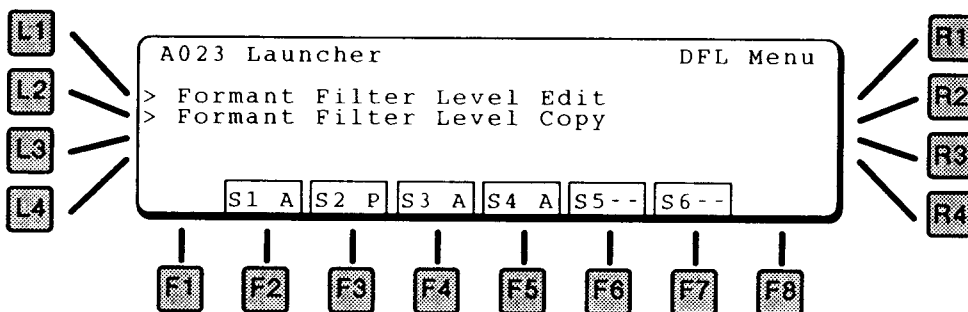

The following chart shows the pitch and frequency of each filter band. The Bias control can be used to slide the entire range up and down.

CENTER FREQUENCY OF 128 BAND FORMANT FILTER (BIAS=0)

Band 70=440Hz.

If the BIAS is set to +12, Band 70=220Hz.

If the BIAS is set to -12, Band 70=880Hz.

The Formant Filter Envelope value works the same as the BIAS.

If the Formant Filter Env. is set to a minus value, the filter moves to the right.

Band	Freq.- Hz.	Key	Band	Freq.- Hz.	Key	Band	Freq.- Hz.	Key	Band	Freq.- Hz.	Key
1	8	C	33	52	G#	65	330	E	97	2093	C
2	9	C#	34	55	A	66	349	F	98	2217	C#
3	9	D	35	58	A#	67	370	F#	99	2349	D
4	10	D#	36	62	B	68	392	G	100	2489	D#
5	10	E	37	65	C	69	415	G#	101	2637	E
6	11	F	38	69	C#	70	440	A	102	2794	F
7	12	F#	39	73	D	71	466	A#	103	2960	F#
8	12	G	40	78	D#	72	494	B	104	3136	G
9	13	G#	41	82	E	73	523	C	105	3322	G#
10	14	A	42	87	F	74	554	C#	106	3520	A
11	15	A#	43	92	F#	75	587	D	107	3729	A#
12	15	B	44	98	G	76	622	D#	108	3951	B
13	16	C	45	104	G#	77	659	E	109	4186	C
14	17	C#	46	110	A	78	698	F	110	4435	C#
15	18	D	47	117	A#	79	740	F#	111	4699	D
16	19	D#	48	123	B	80	784	G	112	4978	D#
17	21	E	49	131	C	81	831	G#	113	5274	E
18	22	F	50	139	C#	82	880	A	114	5588	F
19	23	F#	51	147	D	83	932	A#	115	5920	F#
20	24	G	52	156	D#	84	988	B	116	6272	G
21	26	G#	53	165	E	85	1047	C	117	6645	G#
22	28	A	54	175	F	86	1109	C#	118	7040	A
23	29	A#	55	185	F#	87	1175	D	119	7459	A#
24	31	B	56	196	G	88	1245	D#	120	7902	B
25	33	C	57	208	G#	89	1319	E	121	8372	C
26	35	C#	58	220	A	90	1397	F	122	8870	C#
27	37	D	59	233	A#	91	1480	F#	123	9397	D
28	39	D#	60	247	B	92	1568	G	124	9956	D#
29	41	E	61	262	C	93	1661	G#	125	10548	E
30	44	F	62	277	C#	94	1760	A	126	11175	F
31	46	F#	63	294	D	95	1865	A#	127	11840	F#
32	49	G	64	311	D#	96	1976	B	128	12544	G

LI FORMANT FILTER LEVEL EDIT

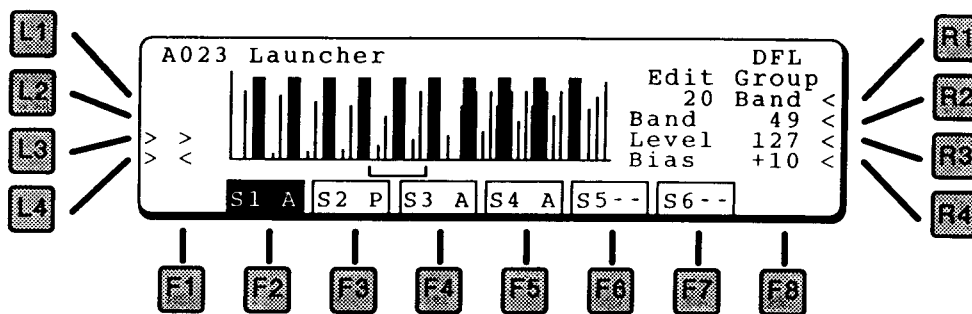

L3 NEXT

L4 PREVIOUS

These buttons select the next or previous group.

R1 EDIT GROUP

The filter bands can be grouped into the following categories. The bracket underneath the bars show which filter bands are selected. The range can be adjusted with the Band control, the level of the selected band with the level control.

GRAPHIC EQ

An eight-band graphic EQ, which creates the typical elliptical EQ pattern in each band.

20 BAND

Operates on 20 of the 128 formant filter bands at one time.

15 BAND

Operates on 15 of the 128 formant filter bands at one time.

10 BAND

Operates on 10 of the 128 formant filter bands at one time.

5 BAND

Operates on 5 of the 128 formant filter bands at one time.

ALL

All 128 Bands.

EACH

Only the selected frequency band, shown by the arrow under the display.

R2 BAND

The range of the filter band to be controlled can be adjusted using the Band control. The bracket shows the selected range.

R3 LEVEL

This adjusts the level of the selected band.

R4 BIAS

The frequencies of the entire formant filter can be moved up and down using the Bias control.

L2 FORMANT FILTER LEVEL COPY

This copies the formant filter settings from a Single patch in memory into the *current* Single patch.

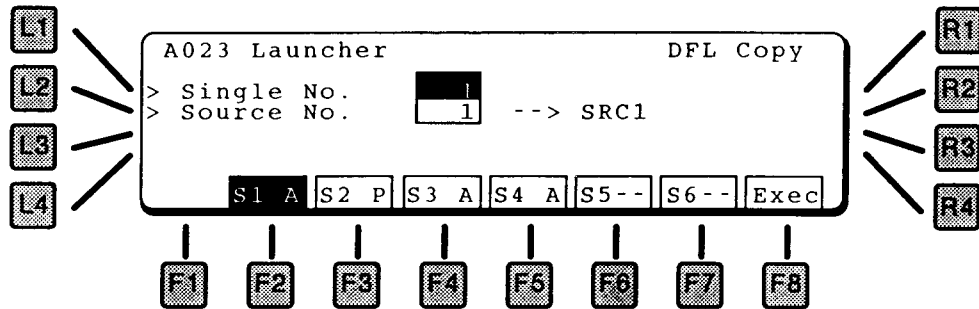

L1 SINGLE NUMBER

This sets the patch to copy the formant filter level settings *from*.

L2 SOURCE NUMBER

This sets the source from the Single patch (selected above) to copy from.

F2 - F7 DESTINATION SOURCE

Press the Source function key to select which source the filter settings will be copied *to*. The display shows the destination as --> SRC#.

F8 EXECUTE

Press this to make the copy.

FORMANT ENVELOPE (DFE)

The formant filter can be swept up and down using an envelope generator or LFO, selected from this screen.

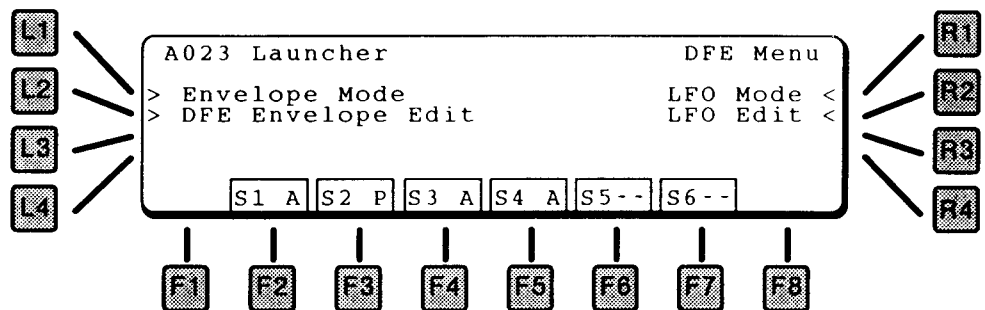

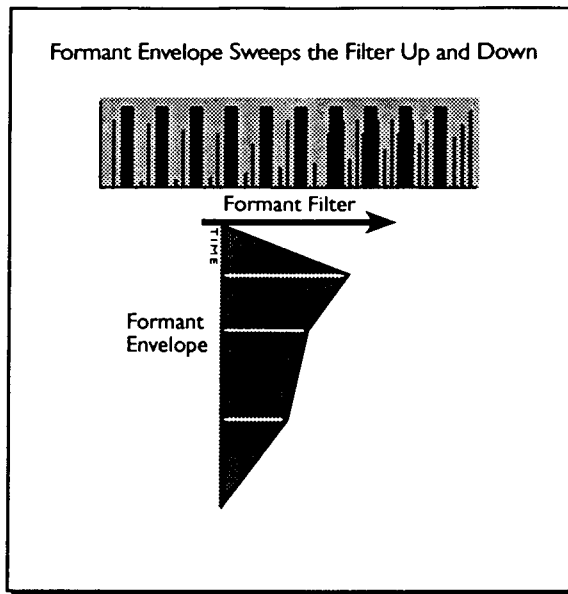

L2 DFE ENVELOPE EDIT

This page contains the parameters for the Formant Filter Envelope. There is one envelope per source.

The envelope diagram shows the visual result of the envelope settings on the page.

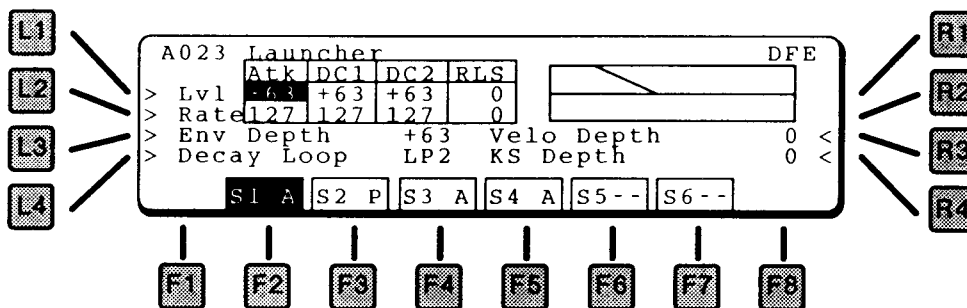

L1 LEVEL

Press L2 to cycle through the level settings for Attack, Decay 1, Decay 2, and Release. Use the Value dial to change the setting.

L2 RATE

Press L3 to cycle through the time settings for Attack, Decay 1, Decay 2, and Release. Use the Value dial to change the setting.

L3 ENV DEPTH

This is the master envelope depth control, which determines how much the envelope controls the filter.

L4 DECAY LOOP

To enhance motion in the sound, the harmonic envelopes can loop among several settings during the sound's sustain. See the diagram on page 42.

OFF

No loop. Envelope goes to the Decay 2 Level and sustains there, the same as the envelopes for the DCF and DCA.

LPI

Loops between Decay 1 Level and Decay 2 Level, at the Decay 2 Rate.

LP2

Loops between Decay 1 Level and Decay 2 Level, but uses *both* Decay 1 and Decay 2 Rates.

R3 VELO DEPTH

The key velocity can be used to adjust the amount of filter modulation by the envelope. With a positive value, the harder a key is played, the more the filter will be moved by the envelope.

R4 KS DEPTH

The key scale (which key is played) can also be used to adjust the amount of filter modulation by the envelope. With a positive value, the higher the note, the more the filter will be moved by the envelope.

R2 LFO EDIT

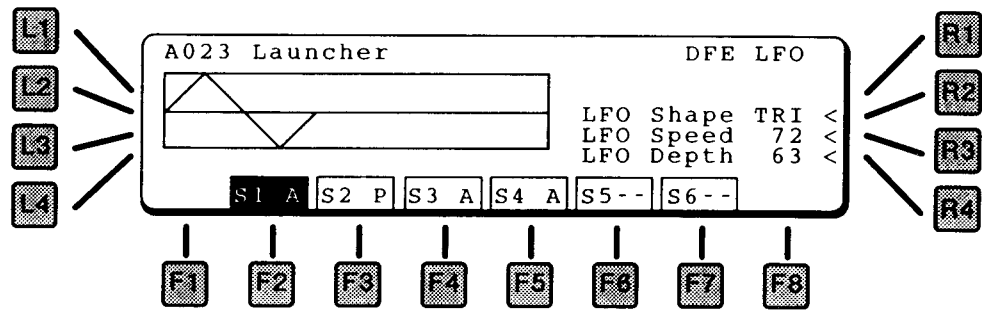

R2 LFO SHAPE

This selects the LFO waveform type:

TRI

Triangle

SAW

Sawtooth

RND

Random

R3 LFO SPEED

Sets the LFO speed.

R4 LFO DEPTH

Sets the initial LFO Depth.

MORF

Morfing lets you create new harmonic shapes by dissolving between four different harmonic *snapshots*. This is done by copying four sources from patches stored in the K5000S.

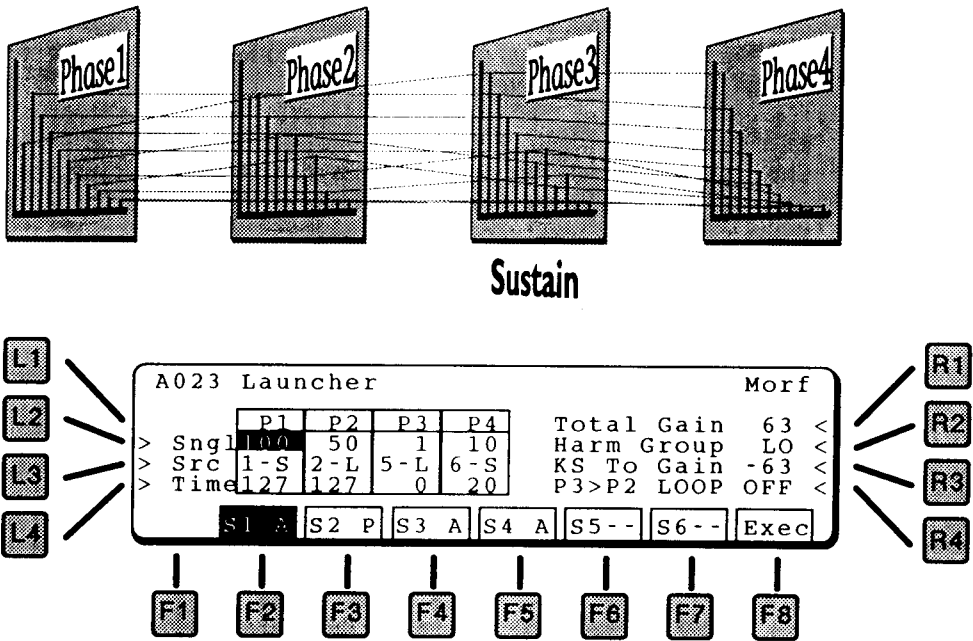

- L2 SINGLE**
This selects which *patch* the source will be copied from. Press this key repeatedly to cycle through the four phases (P1 – P4).
- L3 SOURCE**
This selects the *source* within the single patch (selected by L2) to copied. There are up to six sources, each of which contains a soft harmonic set (S), and a loud harmonic set (L). Press this key repeatedly to cycle through the four phases (P1 – P4).
- L4 TIME**
The transition between phases.
- R1 TOTAL GAIN**
The loudest harmonic will be set to this level, so it functions as a master level.
- R2 HARMONIC GROUP**
This selects the range of harmonics, 1–64 or 65–128.
- R3 KSTO GAIN**
Controls the level with the Key Scale. With a positive value, the harmonics will get louder as higher notes are played on the keyboard.
- R4 P3>P2 LOOP**
If OFF, the harmonics will move according to the selected on this screen, however they will *freeze* once the sustain point is reached. By turning ON the P3>P2 Loop, the harmonics will morf back and forth between phase 2 and phase 3 during sustain, creating constant motion and a more animated sound.
- F8 EXECUTE**
Creates the Morf.

LFO & COPY

The Low Frequency Oscillator is a slow moving (sub-audio) oscillator that is used to modify the DCO, DCF, or DCA to give vibrato and tremolo effects.

A Source Copy function is also included on this page.

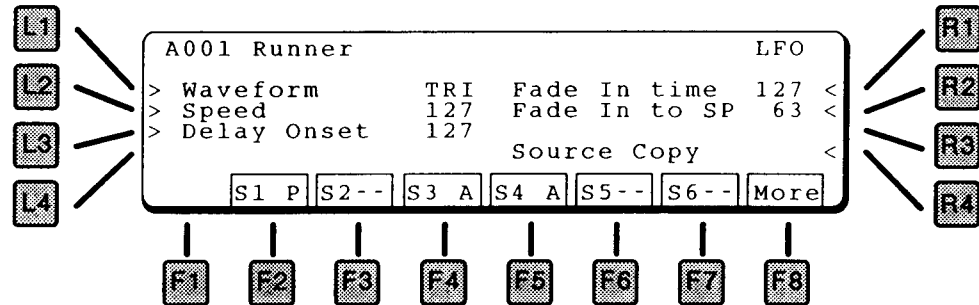

L1 WAVEFORM

This selects the LFO waveform type:

SIN
Sine

TRI
Triangle

SAW
Sawtooth

SQR
Square

RND
Random

L2 SPEED

Sets the LFO initial speed. The range is 0.1Hz to 18Hz.

L3 DELAY ONSET

This adds a delay before the LFO kicks in. The delay can be as long as 2 seconds.

R1 FADE IN TIME

After the delay, this sets the amount of time that the LFO fades in to maximum amount.

R2 FADE INTO SPEED

After the delay, the LFO gradually speeds up to the initial speed setting.

R3 SOURCE COPY

This lets you copy an *entire* source from another patch.

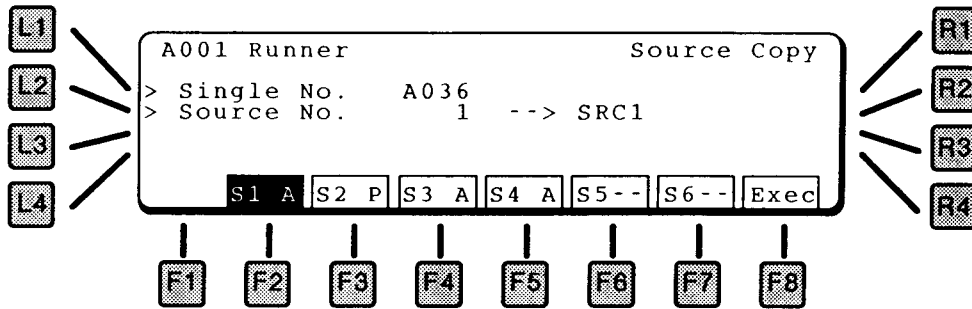

L1 SINGLE NUMBER
Select the Patch to copy from.

L2 SOURCE NUMBER
Select the Source from within the selected patch to copy from, 1 – 6.

F2 – F6 Selects the destination source (in the current patch) for the copy.

F8 EXEC
Executes the copy.

LFO MODULATION

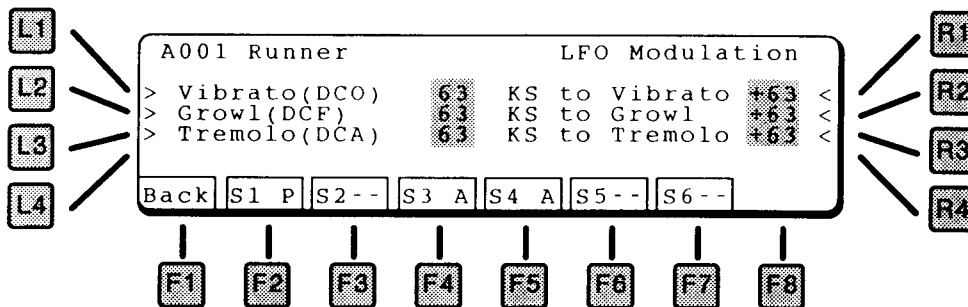

L1 VIBRATO (DCO)
Controls the amount of LFO routed to the DCO, which causes vibrato.

L2 GROWL (DCF)
Controls the amount of LFO routed to the DCF, which causes growl.

L3 TREMOLO (DCA)
Controls the amount of LFO routed to the DCA, which causes tremolo.

R1 KEY SCALE TO VIBRATO
This scales the amount of vibrato depth according to the key played. With a positive value, the amount of vibrato increases as higher notes are played.

R2 KEY SCALE TO GROWL
This scales the amount of DCF growl according to the key played. With a positive value, the amount of growl increases as higher notes are played.

R3 KEY SCALE TO TREMOLO
This scales the amount of tremolo depth according to the key played. With a positive value, the amount of tremolo increases as higher notes are played.

CONTROL

The Control pages contain settings for real time control of the sound.

VOLUME, PITCH BEND, PAN

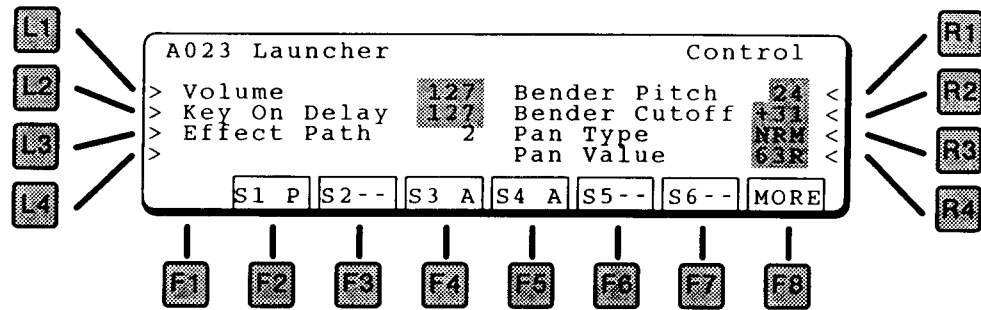

L1 VOLUME

This is the master volume for the sound source.

L2 KEY ON DELAY

This sets a delay between the time the key is struck and the sound starts.

L3 EFFECT PATH

Routes this source to one of the four inputs to the effects section. For more on effects please see page 61.

Effect Path routes the source to one of these Effect inputs

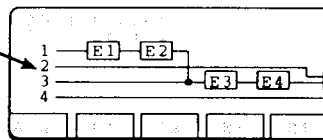

R1 BENDER PITCH

The maximum amount of pitch bend, in semitones.

R2 BENDER CUTOFF

The Pitch Bend control also can affect the filter. If you bend *up*, the filter cutoff goes up and the sound gets brighter. If you bend *down* the filter cutoff goes down and the sound gets darker.

R3 PANTYPE

This sets the type of panning.

NRM (Normal) is a standard left to right pan, controlled by the Pan Value, below.

RND (Random) changes the panning randomly for each note played. This gives a feeling of an "ensemble of players" when used for a string patch, for example.

KS & -KS(Key Scale and Negative Key Scale) changes the panning depending upon the key played. KS pans from left to right, -KS pan from right to left. Using KS will simulate the natural panning of strings inside a piano.

R4 PANVALUE

Places the sound left to right in the stereo field.

F8 MORE

Press to go to the Zone screen, below.

KEY AND VELOCITY ZONE

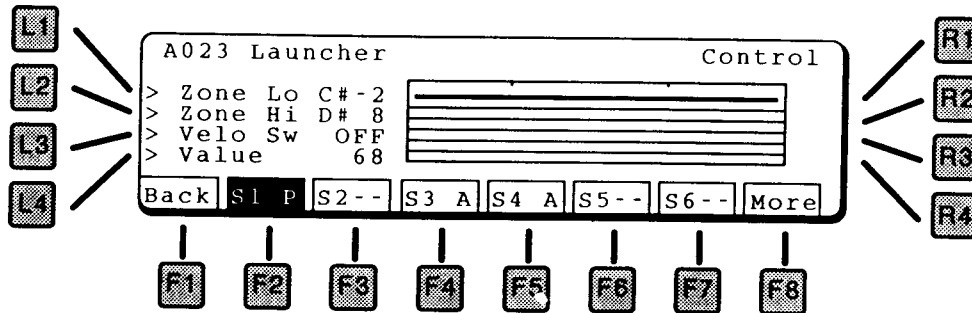

This screen has parameters for key and velocity range. Using these parameters, a sound can be limited to play in only a certain range of the keyboard, or only when a key is played hard or soft. By creating several sources, for example, one that plays on soft notes only and another that plays on hard notes only, a sound can be created with more lifelike variation.

L1 ZONE LO

Sets the lowest note that will be played. The keyboard graphic visually shows the range.

L2 ZONE HI

Sets the highest note that will be played.

L3 VELOCITY SWITCH

Sets the velocity range. At Loud, only hard (loud) notes will sound. At Soft, only soft notes will sound. When set to OFF, the velocity switch is turned off and notes play at all velocity levels.

L4 VALUE

Sets the threshold between high and low velocity. This is the MIDI velocity number.

F1 BACK

Press to return to the previous screen.

F8 MORE

Press to go to the controller screen, below.

CONTROLLERS

The next two screens contain settings for aftertouch pressure, modulation wheel, and expression pedal control of the sound. Following these is a screen for Assignable Controllers.

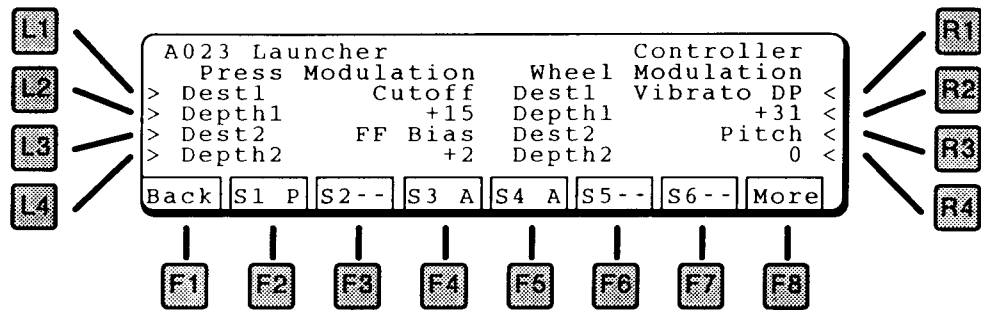

PRESSURE MODULATION

Channel Pressure, or *aftertouch*, can be routed to two destinations simultaneously (actually a *third* destination is possible by using the Assignable Controllers, page 58).

L1 DESTINATION 1

Selects the destination for the modulation. The destination can be any of those listed below.

L2 DEPTH 1

Sets the amount of the modulation. This can be positive or negative.

L3 DESTINATION 2

Selects the destination for the modulation. The destination can be any of those listed below.

L4 DEPTH 2

Sets the amount of the modulation. This can be positive or negative.

WHEEL MODULATION

The Modulation Wheel can be routed to two destinations simultaneously (actually a *third* destination is possible by using the Assignable Controllers, page 58). The Modulation Wheel is MIDI Controller 1.

R1 DESTINATION 1

Selects the destination for the modulation. The destination can be any of those listed below.

R2 DEPTH 1

Sets the amount of the modulation. This can be positive or negative.

R3 DESTINATION 2

Selects the destination for the modulation. The destination can be any of those listed below.

R4 DEPTH 2

Sets the amount of the modulation. This can be positive or negative.

F1 BACK
Press to return to the previous screen.

F8 MORE
Press to go to the expression pedal modulation screen, below.

EXPRESSION PEDAL

This screen contains settings for control of the sound using the expression pedal (MIDI controller 11).

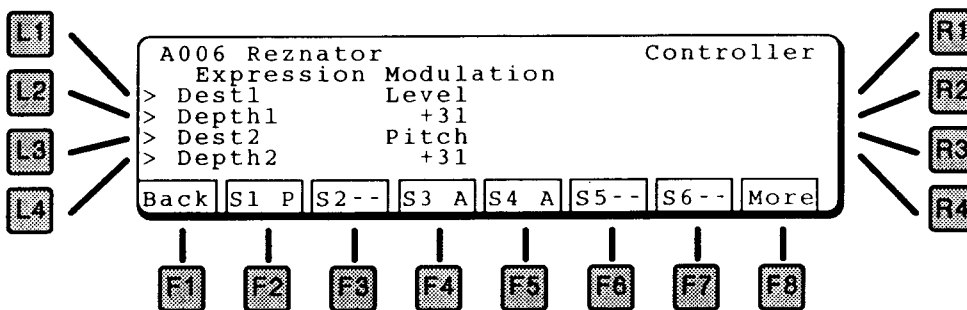

L1 DESTINATION 1
Selects the destination for the modulation. The destination can be any of those listed below.

L2 DEPTH 1
Sets the amount of the modulation. This can be positive or negative.

L3 DESTINATION 2
Selects the destination for the modulation. The destination can be any of those listed below.

L4 DEPTH 2
Sets the amount of the modulation. This can be positive or negative.

F1 BACK
Press to return to the previous screen.

F8 MORE
Press to go to the Assignable Controller screen, below.

MODULATION DESTINATIONS

Any of the modulation sources on these pages can be routed to any of the following destinations:

PITCH
Modifies the pitch. With a positive value, increasing the control makes the pitch go up, with a negative value, increasing the control makes the pitch go down.

CUTOFF
Modifies the filter cutoff. With a positive value, increasing the control makes the sound brighter, with a negative value, increasing the control makes the sound darker.

LEVEL
Modifies the volume. With a positive value, increasing the control makes the sound louder, with a negative value, increasing the control makes the sound softer.

VIBRATO DEPTH

Adds Vibrato (LFO controls pitch). This parameter sets the amount of vibrato.

GROWL DEPTH

Adds Growl (LFO controls filter). This parameter sets the amount of growl.

TREMOLO DEPTH

Adds Tremolo (LFO controls volume). This parameter sets the amount of tremolo.

LFO SPEED

Modifies the LFO speed. With a positive value, increasing the control makes the LFO faster, with a negative value, increasing the control makes the LFO slower.

ATTACK TIME

Controls the DCF & DCA Attack time. With a positive value, a higher key will have a longer attack time and a lower key will have a shorter attack time.

DECAY1 TIME

Controls the DCF & DCA Decay1 time. With a positive value, a higher key will have a longer decay time and a lower key will have a shorter time.

RELEASE TIME

Controls the DCF & DCA Release time. With a positive value, a higher key will have a longer release time and a lower key will have a shorter time.

VELOCITY OFFSET

Scales the velocity, plus and minus.

RESONANCE

Controls the amount of filter resonance.

PANPOT

Controls the Left/Right panning of the sound

FORMANT FILTER BIAS

This control adjusts the Formant Filter Bias.

FORMANT FILTER ENV/LFO DEPTH

This control adjusts the Formant Filter LFO Depth.

FORMANT FILTER ENV/LFO SPEED

This control adjusts the Formant Filter LFO Speed.

HARMONICS LO

Controls the level of the lower harmonics. This does not adjust the *low notes*, rather it adjusts the *low end* of any note.

HARMONICS HI

Controls the level of the upper harmonics. This does not adjust the *high notes*, rather it adjusts the *high end* of any note.

HARMONICS EVEN

Controls the level of the even harmonics.

HARMONICS ODD

Controls the level of the odd harmonics, including the *fundamental*, or base pitch.

ASSIGNABLE CONTROLLER

Two additional controllers can be used for modulation. The controllers are assigned from the following screen.

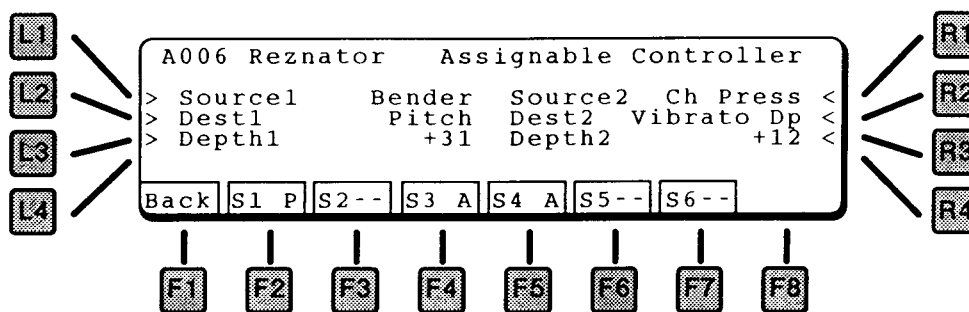

L1 SOURCE1

Selects the source for the modulation. The source can be any of those listed below.

L2 DESTINATION1

Selects the destination for the modulation. The destination can be any of those listed on page 56.

L3 DEPTH1

Sets the amount of the modulation. This can be positive or negative.

R1 SOURCE2

Selects the source for the modulation. The source can be any of those listed below.

R2 DESTINATION2

Selects the destination for the modulation. The destination can be any of those listed on page 56.

R3 DEPTH2

Sets the amount of the modulation. This can be positive or negative.

ASSIGNABLE CONTROLLER SOURCES

The following sources can be used for modulation:

BENDER

The Pitch Bend wheel.

CH PRESS (CHANNEL PRESSURE)

Aftertouch pressure (per channel).

WHEEL

The Modulation Wheel

EXPRESS (EXPRESSION PEDAL)

The Expression Pedal, MIDI Controller 11

MIDI VOLUME

The MIDI Volume command, MIDI Controller 7

PANPOT

The MIDI Pan command, MIDI Controller 10

G CONT 1 ~ 8 (GENERAL CONTROLLERS 1~ 8)

The eight MIDI General Purpose Controllers – controller numbers 16–19 & 80–83.

WRITE

After editing, save your sound by pressing the WRITE button in the COMMON section of the front panel. The following screen appears.

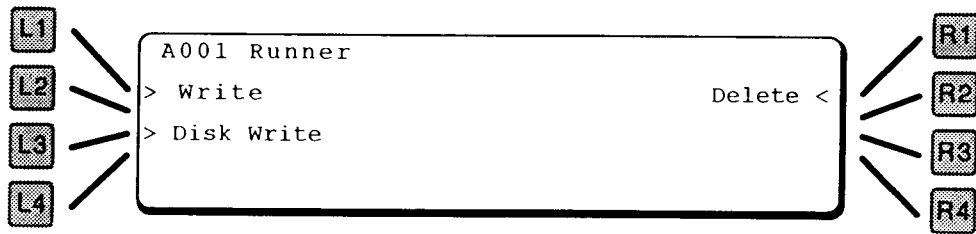

L1 WRITE

This saves your patch to the internal memory area.

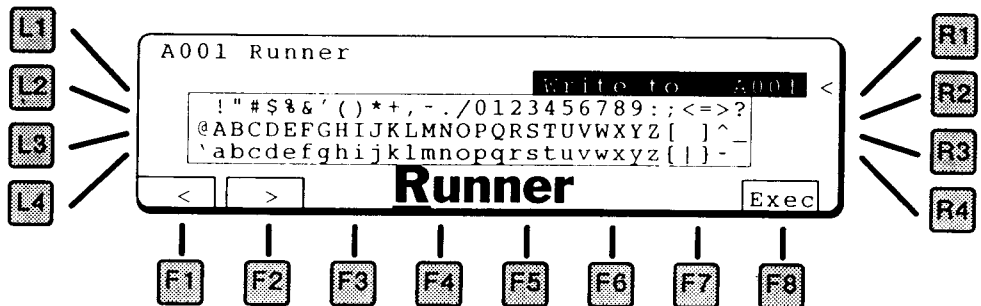

R1 WRITE LOCATION

Use the Value dial to select a location to save your patch.

NOTE:

If the message "Memory Full" appears on the display, select another bank (A or D) or use the Disk Write function (below) instead.

F1/F2 CHARACTER

This names the patch. Use the F1 and F2 keys to select a character in the name (moves the cursor), and the Value dial to select a letter.

F8 EXECUTE

Stores the patch.

L3 DISK WRITE

You can also write ADD Patches to disk. This is useful if your internal memory is full.

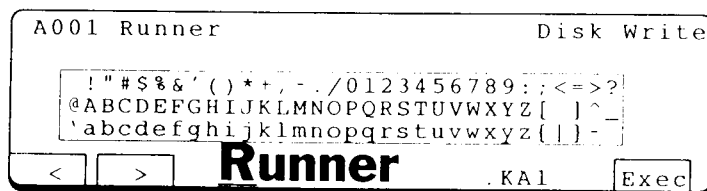

F1/F2 CHARACTER

This names the file on the disk. Use the F1 and F2 keys to select a character in the name (moves the cursor), and the Value dial to select a letter.

F8 EXECUTE

Press Execute to save the file. It will be saved with the file extension shown after the name.

RI DELETE

Since there is not a fixed number of ADD patches in the Single Bank, you may need to delete patches to make room for new ones.

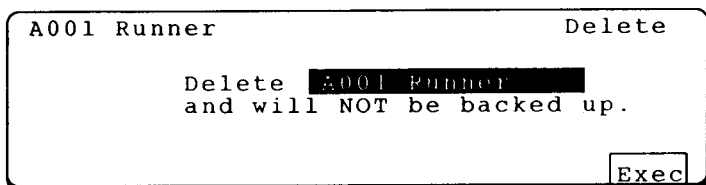

Use the Value dial to choose the patch to delete, and press F8 (Execute). Sure? Press **F8** to continue.

EFFECT SECTION

The Effect section contains the settings for the digital effects generator.

There is one Effect generator for the entire K5000. When in Single mode, the entire effect generator is available for the sound. When in Multi mode, the effects settings of the Single patch are disregarded, and the Multi effects settings are used instead.

EFFECT PAGE PARAMETERS

The main effects page displays a block diagram of the algorithm selected.

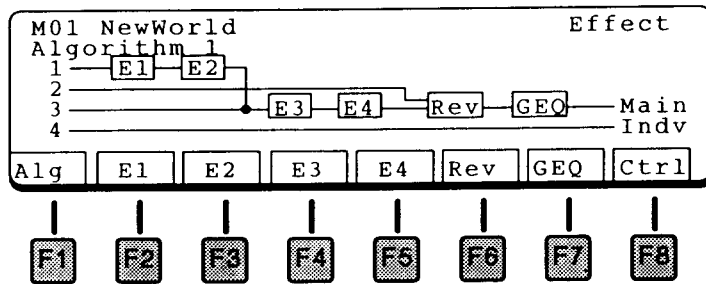

VALUE DIAL ALGORITHM SELECT

The algorithm can be selected by turning the Value dial. In Single mode, press **R1** to access the Algorithm select.

F1 ALGORITHM PAGE

Returns to the Algorithm Page, *this page*, from other effects pages.

F2 E1 (EFFECT 1)

Goes to the edit parameters for the Effect 1 block. Any of the effects blocks can be assigned one of 36 different effects, which include a variety of delays, chorus, flanging, and distortion. The available controls vary from one effect to another.

See page 67 for a description of the 36 available effect types.

F3 E2 (EFFECT 2)

Goes to the edit parameters for the Effect 2 block.

F4 E3 (EFFECT 3)

Goes to the edit parameters for the Effect 3 block.

F5 E4 (EFFECT 4)

Goes to the edit parameters for the Effect 4 block.

F6 REVERB

Goes to the edit parameters for the Reverb block. The reverb block can be assigned one of 11 different reverb types, which include a variety of rooms, halls and, plates. The available controls vary from one reverb type to another.

See page 92 for a description of the available reverb types.

F7 GRAPHIC EQ

Goes to the edit parameters for the Graphic EQ block.

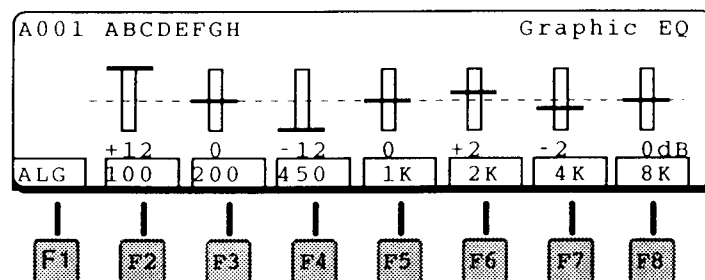

Use the F2 through F8 keys to select an EQ band, and the Value dial to change the amount. The slider will change to visually indicate the setting, the number underneath shows the exact amount.

F8 CONTROL

Goes to the Effect Controller page, below. Two controllers can be used to control effect or reverb depth. An expression pedal could be used to add reverb or aftertouch pressure could be used to add chorusing.

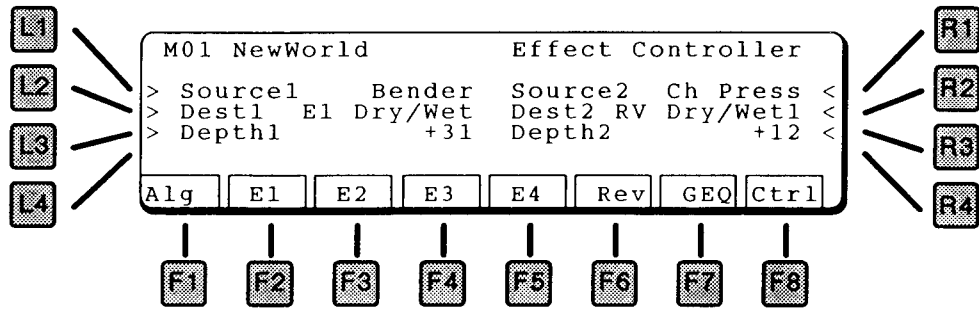

L1 SOURCE1

Selects the source for the modulation. The source can be any of those listed below.

L2 DESTINATION 1

Selects the destination for the modulation. This can be the level of the reverb, or a modulatable parameter in one of the four effects blocks (Effect1 – Effect4).

L3 DEPTH1

Sets the amount of the modulation. This can be positive or negative.

R1 SOURCE2

Selects the source for the modulation. The source can be any of those listed below.

R2 DESTINATION2

Selects the destination for the modulation. This can be the level of the reverb, or a modulatable parameter in one of the four effects blocks (Effect1 – Effect4).

R3 DEPTH2

Sets the amount of the modulation. This can be positive or negative.

MODULATION SOURCES

The sources that can be used to control the effects are:

BENDER

The Pitch Bend wheel.

CH PRESS (CHANNEL PRESSURE)

Aftertouch pressure (per channel).

WHEEL

The Modulation Wheel

EXPRESS (EXPRESSION PEDAL)

The Expression Pedal

MIDI VOLUME

The MIDI Volume command, MIDI Controller 7

PANPOT

The MIDI Pan command, MIDI Controller 10

SOURCE ASSIGNMENT GRID (SINGLE PATCH ONLY)

In Single mode, the Source Assignment Grid on the left side of the screen is used to connect the (up to) six sources in each patch to the four inputs of the effect algorithm.

Press any of the left hand buttons to access the Source Assignment Grid.

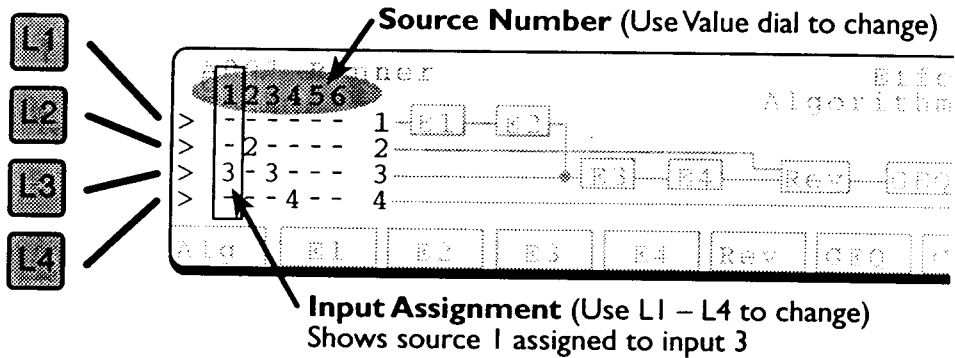

VALUE DIAL

Selects which source to assign. Sources 1 through 6 are displayed, but only the sources actually used in the Single patch can be assigned.

- L1 INPUT 1 ASSIGN**
- L2 INPUT 2 ASSIGN**
- L3 INPUT 3 ASSIGN**
- L4 INPUT 4 ASSIGN**

After selecting a source with the value dial, press the L1, L2, L3, or L4 buttons to assign that source to input 1, 2, 3, or 4, respectively. The number 1, 2, 3, or 4 is displayed in the column indicating its assignment.

ALGORITHMS

Anatomy of an Effect Algorithm

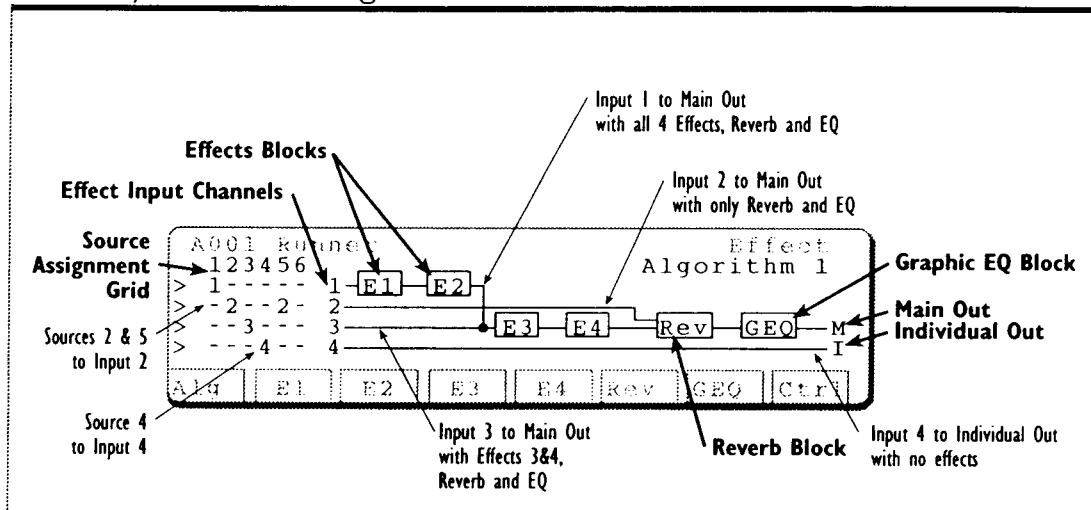

The Value dial (**R1**) selects the effect algorithm to be used. There are four different algorithms available, and the arrangement of the effects blocks varies depending upon the algorithm chosen.

There are four input channels into the effects algorithms. In Single mode, the left of the block diagram shows the Source Assignment Grid, with controls routing of each source to the input channels. In Multi or Compose mode, the assignment of each single section to the four input channels is controlled by the Effect Path function in the Section menu.

ALGORITHM 1

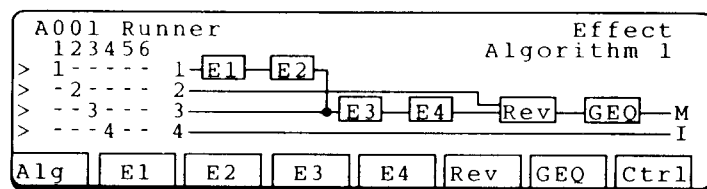

Input 1 passes through all four effects blocks, on its way to the reverb, EQ and main outputs. It merges with input 3 after the second effects block.

Input 2 goes directly to the reverb block, EQ, and main outputs. It has its own wet/dry mix in the reverb block.

Input 3 passes through two of the four effects blocks, on its way to the reverb, EQ and main outputs.

Input 4 goes directly to the Individual outputs without any effect, reverb or EQ. This is useful for sending sounds directly out of the K5000S for external signal processing.

ALGORITHM 2

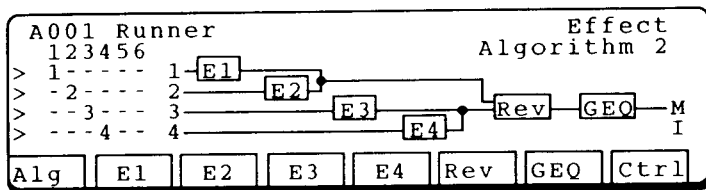

In this algorithm, each input goes through its own effects block, then the four are paired together for reverb and EQ.

ALGORITHM 3

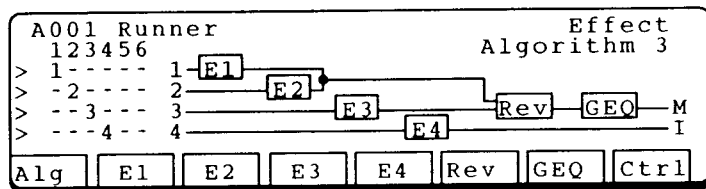

In this algorithm, each input goes through its own effects block, then 1, 2, and 3 are Multined for reverb and EQ.

Input 3 has its own wet/dry mix in the reverb block.

After passing through its effect, Input 4 goes directly to the Individual outputs. This could be useful for a Bass sound running through a phaser, but without reverb.

ALGORITHM 4

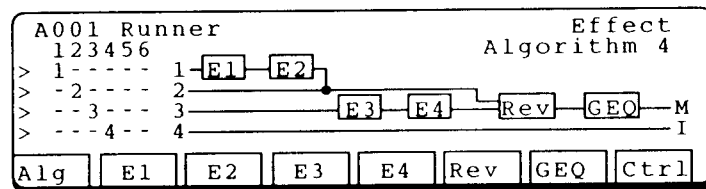

Input 1 passes through the E1 and E2 effects blocks, on its way to the reverb, EQ and main outputs. It merges with input 2 after the second effects block.

Input 2 goes directly to the reverb block, EQ, and main outputs.

Input 3 passes through E3 and E4 of the four effects blocks, on its way to the reverb, EQ and main outputs. It has its own wet/dry mix in the reverb block.

Input 4 goes directly to the Individual outputs without any effect, reverb or EQ.

EFFECT TYPES

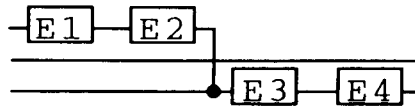

The four effects blocks represent individual effects. Any of the effects blocks can be assigned one of 36 different effects, which include a variety of delays, chorus, flanging, and distortion. The available controls vary from one effect to another.

EARLY REFLECTION 1 EARLY REFLECTION 2

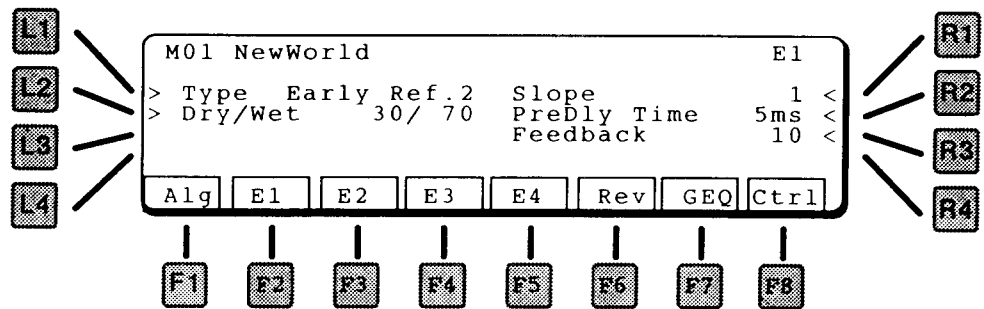

L1 TYPE

Selects the type of effect. Early Reflection 1 has a shorter reflection time than Early Reflection 2.

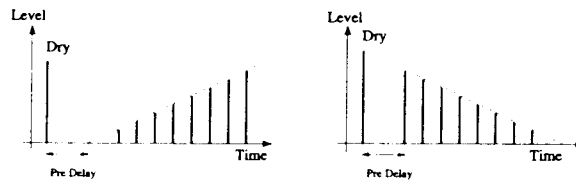
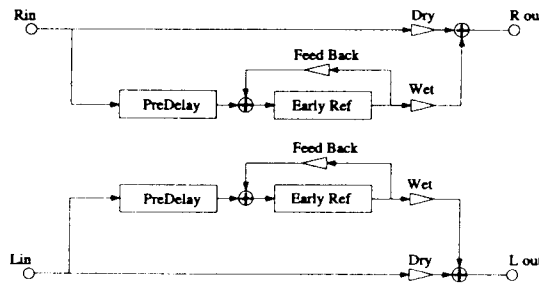

L2 DRY/WET

Controls the ratio between the original sound (dry) and the effected sound (wet).

R1 SLOPE

This softens the reflection by changing the delay amplitudes. See diagram.

R2 PREDELAY TIME

The amount of delay time before the effect.

R3 FEEDBACK

Amount of delay looped back into the input. This creates a repeating delay.

TAP DELAY 1 TAP DELAY 2

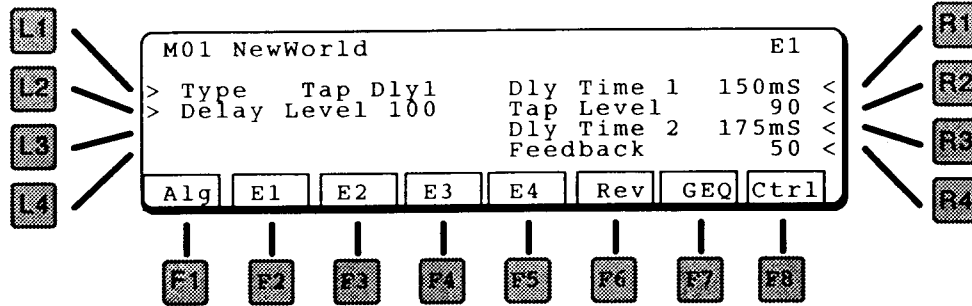

L1 TYPE

Selects the type of effect.

TAP DELAY 1

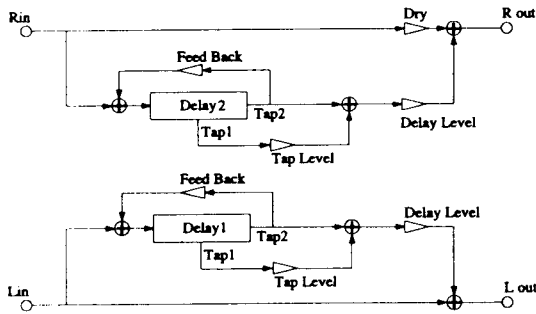

TAP DELAY 2

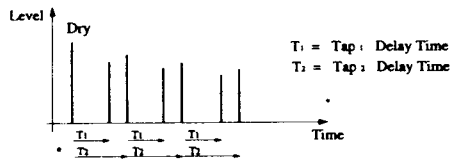
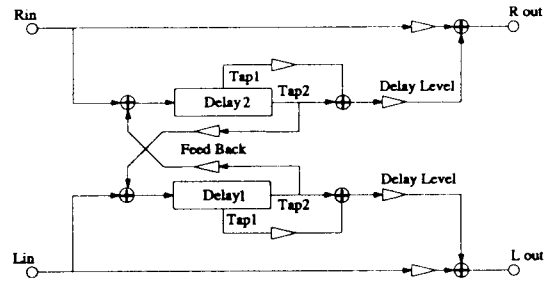

L2 DELAY LEVEL

Master level of this effect block.

R1 DELAY TIME 1

The delay time for delay 1.

R2 TAP LEVEL

The level of delay 1.

R3 DELAY TIME 2

The delay time for delay 2.

R4 FEEDBACK

Amount of delay looped back into the input. This creates a repeating delay. The original sound (input) and Delay 1 are repeated together at the delay 2 time.

SINGLE DELAY

This effect has a single delay, with a fine time adjustment for synchronizing to the beat.

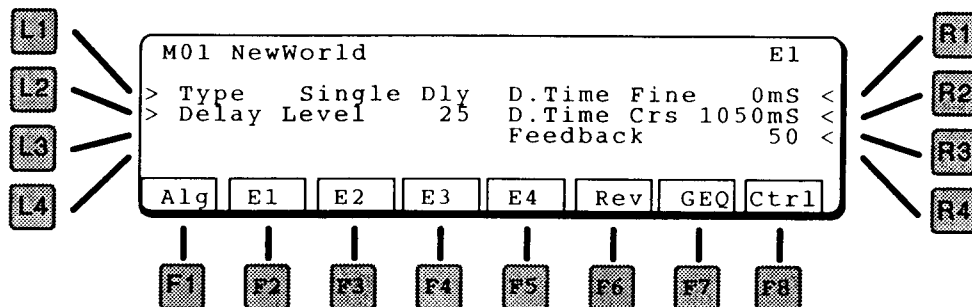

L1 TYPE

Selects the type of effect.

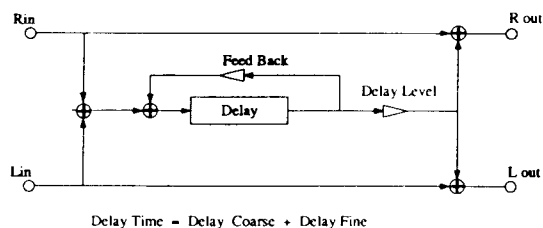

L2 DELAY LEVEL

Master level of this effect block.

R1 DELAY TIME FINE

Adjusts the delay time in 1 mS increments, from 0 - 9 mS.

R2 DELAY TIME COARSE

Adjusts the delay time in 10mS increments, from 0 - 1270 mS. (1.27 seconds)

R3 FEEDBACK

Amount of delay looped back into the input. This creates a repeating delay.

DUAL DELAY

This effect has two delays, panned hard left and right.

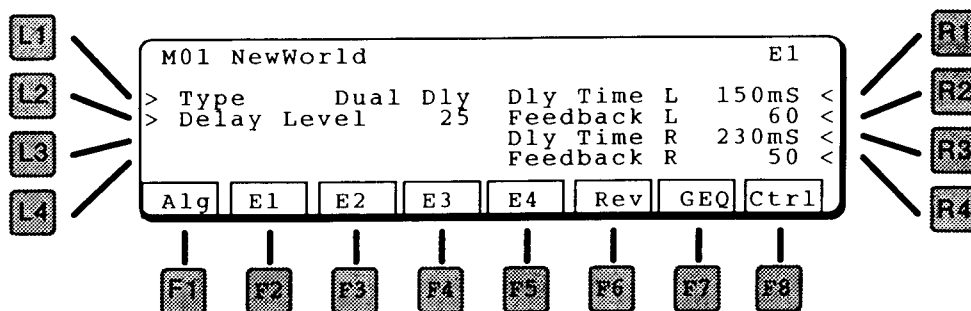

L1 TYPE

Selects the type of effect.

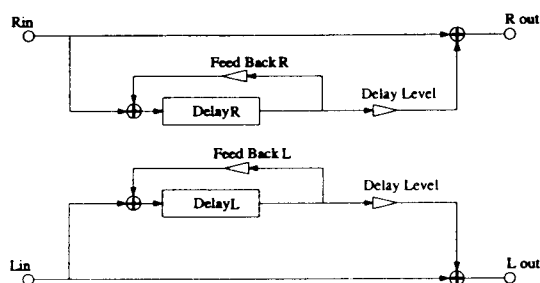

L2 DELAY LEVEL

Master level of this effect block.

R1 DELAY TIME LEFT

Adjusts the delay time from 0 - 720mS.

R2 FEEDBACK LEFT

Amount of delay looped back into the input. This creates a repeating delay.

R3 DELAY TIME RIGHT

Adjusts the delay time from 0 - 720mS.

R4 FEEDBACK RIGHT

Amount of delay looped back into the input. This creates a repeating delay.

STEREO DELAY

This is a single stereo delay. Repeats maintain the same stereo panning as the original signal.

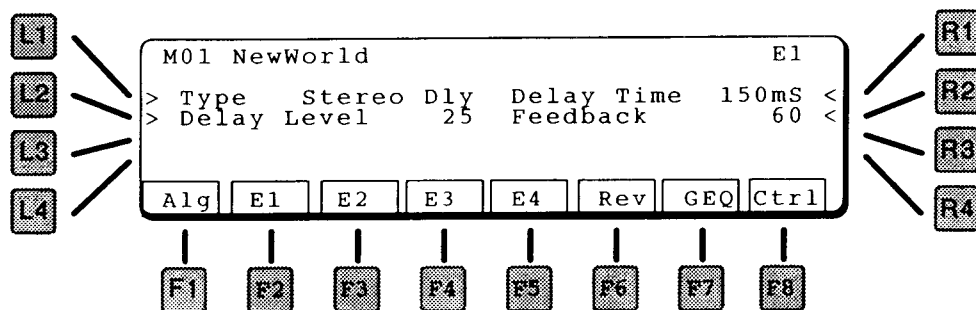

L1 TYPE
Selects the type of effect.

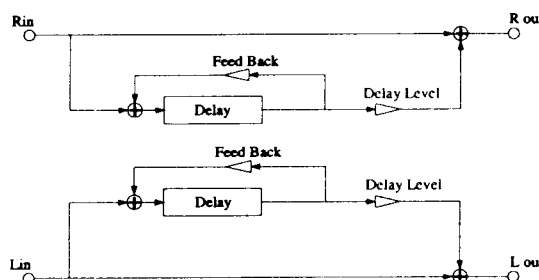

L2 DELAY LEVEL
Master level of this effect block.

R1 DELAY TIME
Adjusts the delay time from 0 - 720 mS.

R2 FEEDBACK
Amount of delay looped back into the input. This creates a repeating delay.

CROSS DELAY

Cross Delay is a single delay, with repeats alternating left and right.

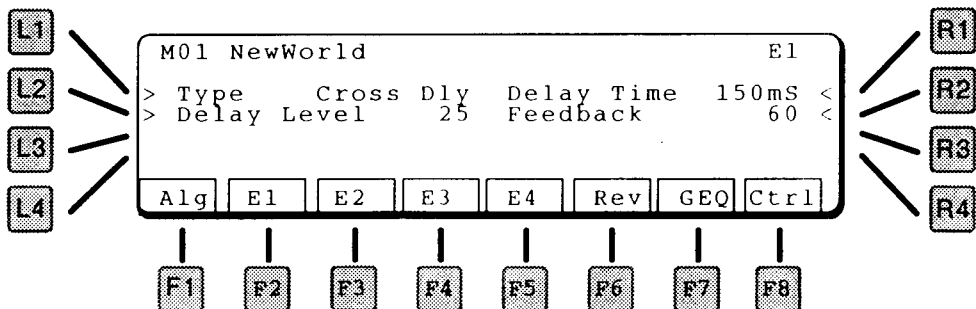

- L1 TYPE**
Selects the type of effect.

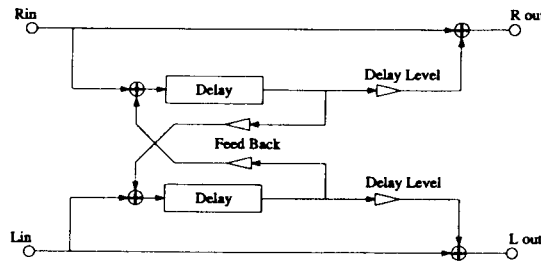

- L2 DELAY LEVEL**
Master level of this effect block.
- R1 DELAY TIME**
Adjusts the delay time from 0 - 720 mS.
- R2 FEEDBACK**
Amount of delay looped back into the input. This creates a repeating delay.

AUTO PAN

Auto Pan moves the input source back and forth across the stereo field.

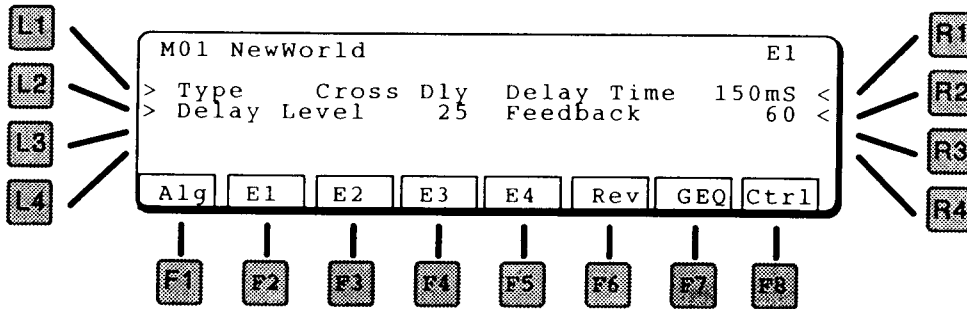

- L1 TYPE**
Selects the type of effect.

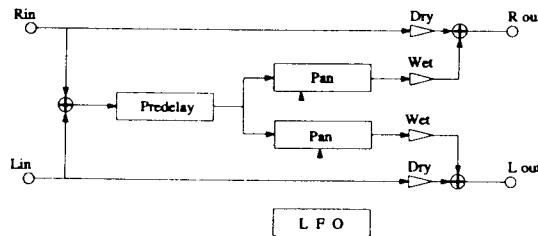

- L2 DRY/WET**
Controls the ratio between the original (dry) and the panned sound (wet).
- R1 SPEED**
Adjusts the panning speed.
- R2 DEPTH**
Controls how wide the panning is.

R3 PREDELAY TIME

Adds a delay (up to 100mS) before the panned sound starts

R4 WAVE

Selects the LFO waveform used to control the panning. The choices are SINE or TRIangle.

AUTO PAN & DELAY

Auto Pan moves the input source back and forth across the stereo field, with an added delay.

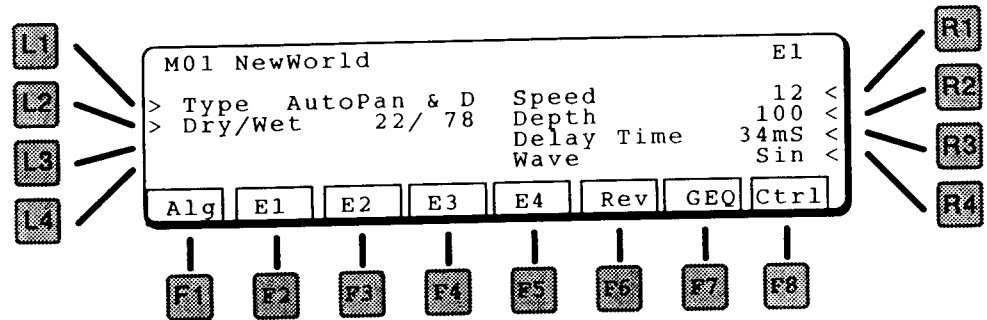
**L1 TYPE**

Selects the type of effect.

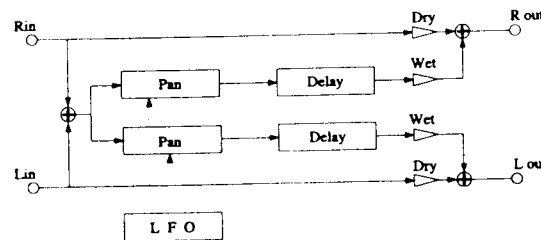
**L2 DRY/WET**

Controls the ratio between the original (dry) and the panned sound (wet).

R1 SPEED

Adjusts the panning speed.

R2 DEPTH

Controls how wide the panning is.

R3 DELAY TIME

Delays the panned sound (up to 200mS) The repeating delay does not pan.

R4 WAVE

Selects the LFO waveform used to control the panning. The choices are SINE or TRIangle.

CHORUS 1

CHORUS 2

Chorus is a slight detune of the sound, which adds depth and richness to the sound. Great for guitars, electric pianos, organs, strings, choirs.

Chorus 1 is a true stereo in / stereo out chorus – the left and right channels are independent.

Chorus 2 is a mono in / stereo out chorus – the left and right channels are summed together before entering a stereo chorus unit.

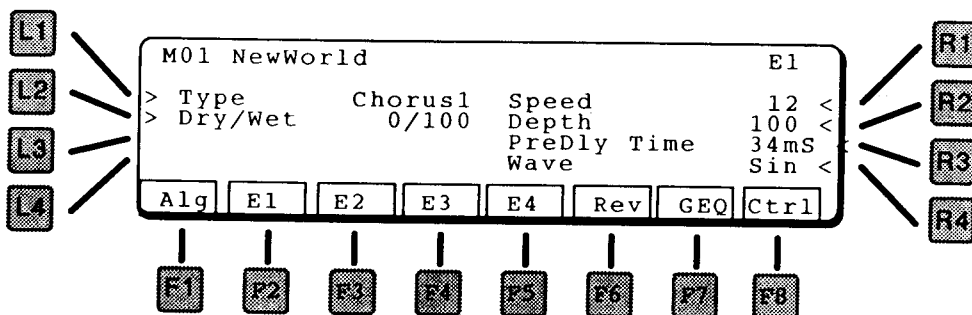

L1 TYPE
Selects the type of effect.

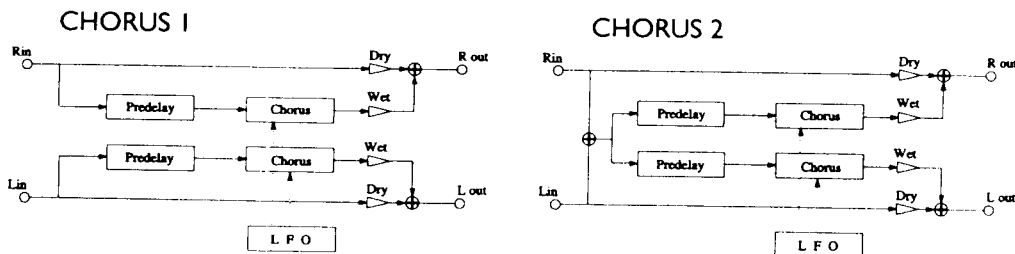

- L2 DRY/WET**
Controls the ratio between the original (dry) and the chorused sound (wet).
- R1 SPEED**
Adjusts the chorus speed.
- R2 DEPTH**
Controls how wide the detune is.
- R3 PREDELAY TIME**
Adds a delay (up to 100mS) before the chorus sound starts.
- R4 WAVE**
Selects the LFO waveform used to control the panning. The choices are SINE or TRIangle.

CHORUS 1 & DELAY

CHORUS 2 & DELAY

Chorus 1 is a true stereo in / stereo out chorus – the left and right channels are independent.

Chorus 2 is a mono in / stereo out chorus – the left and right channels are summed together before entering a stereo chorus unit.

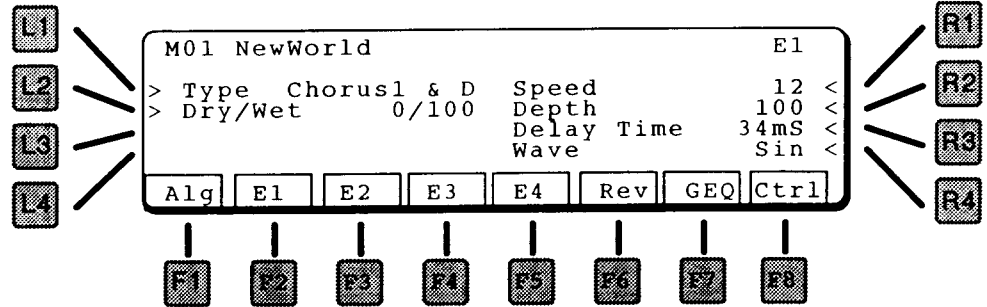

L1 TYPE
Selects the type of effect.

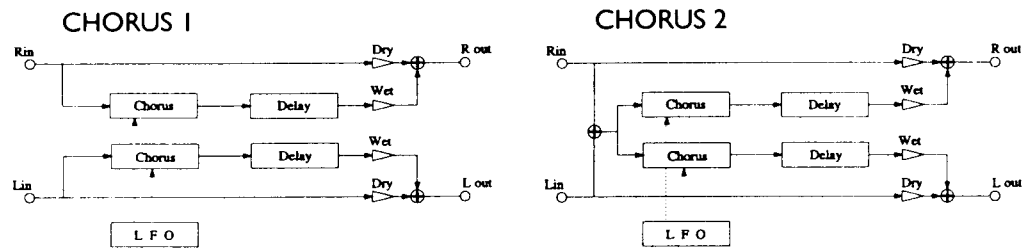

L2 DRY/WET
Controls the ratio between the original (dry) and the chorused sound (wet).

R1 SPEED
Adjusts the chorus speed.

R2 DEPTH
Controls how wide the detune is.

R3 DELAY TIME
Adds a repeating delay of the chorused sound (up to 200mS).

R4 WAVE
Selects the LFO waveform used to control the panning. The choices are SINE or TRIangle.

FLANGER 1

FLANGER 2

Flange is a slight detune of the sound, with an airy phasing, which adds depth to the sound. Great for guitars and electric pianos.

In Flanger 1, the flange control is 180° out of phase between the left and right channels. In Flanger 2, the flange control is *in* phase between the left and right channels.

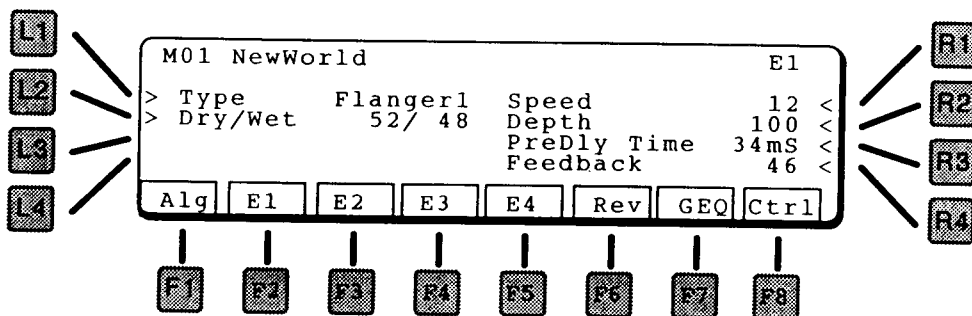

L1 TYPE
Selects the type of effect.

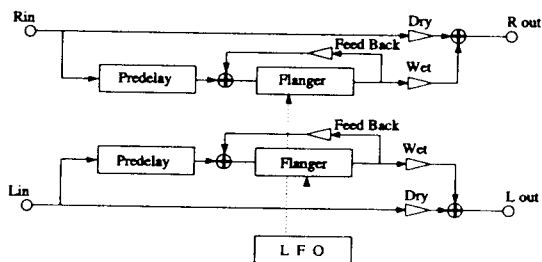

- L2 DRY/WET**
Controls the ratio between the original (dry) and the flanged sound (wet).
- R1 SPEED**
Adjusts the flanger speed.
- R2 DEPTH**
Controls how wide the detune is.
- R3 PREDELAY TIME**
Adds a delay (up to 100mS) before the flanger starts.
- R4 FEEDBACK**
Controls the feedback of the flanging sound.

FLANGER 1 & DELAY

FLANGER 2 & DELAY

In Flanger 1, the flange control is 180° out of phase between the left and right channels. In Flanger 2, the flange control is in phase between the left and right channels.

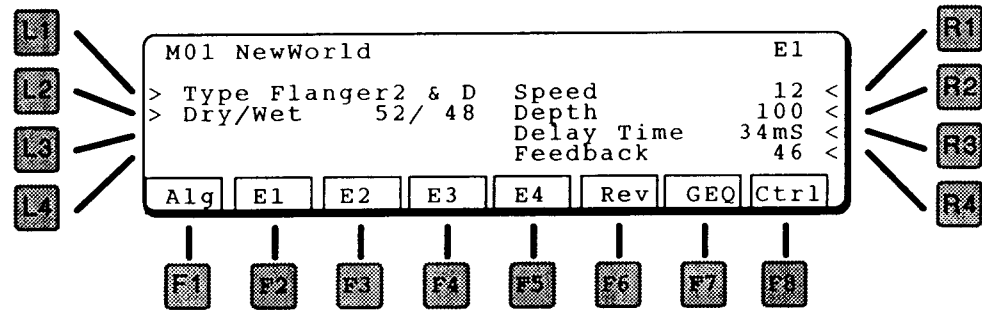

L1 TYPE

Selects the type of effect.

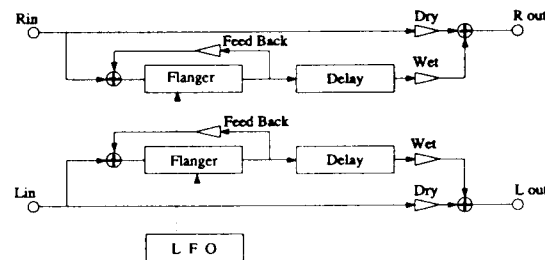

L2 DRY/WET

Controls the ratio between the original (dry) and the flanged sound (wet).

R1 SPEED

Adjusts the flanger speed.

R2 DEPTH

Controls how wide the detune is.

R3 DELAY TIME

Adds a repeating delay of the flanged sound (up to 200mS).

R4 FEEDBACK

Controls the feedback of the flanging sound. Does not affect the delay.

ENSEMBLE

Ensemble is a three phase chorus, with each of the three chorus units at a different phase and frequency. This gives a slightly richer sound than the Celeste effect, below.

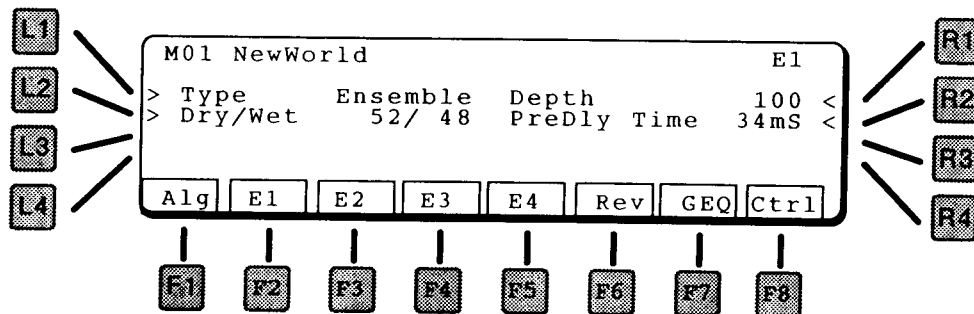

L1 TYPE

Selects the type of effect.

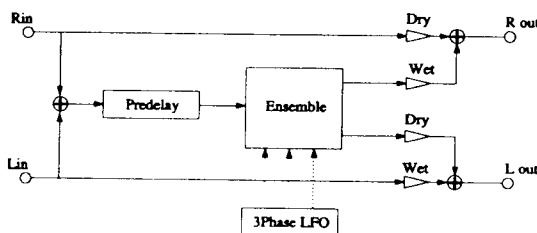

L2 DRY/WET

Controls the ratio between the original (dry) and the chorused sound (wet).

R1 DEPTH

Adjusts the amount of effect.

R2 PREDELAY TIME

Adds a delay (up to 100mS) before the ensemble starts.

ENSEMBLE & DELAY

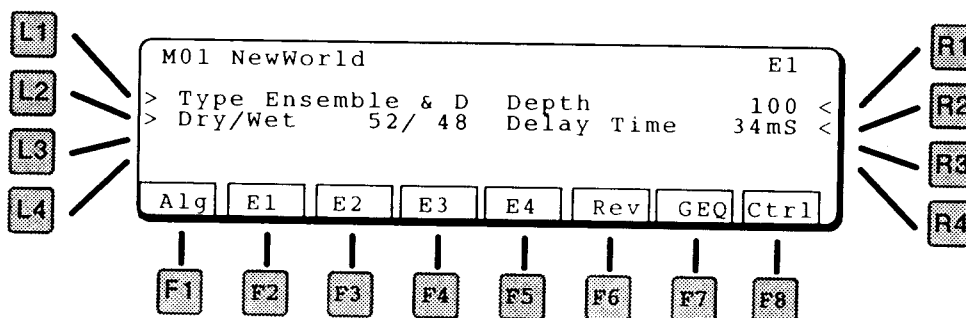

L1 TYPE
Selects the type of effect.

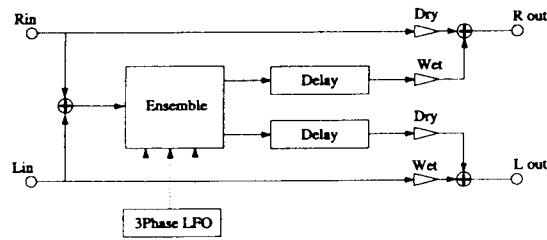

L2 DRY/WET
Controls the ratio between the original (dry) and the chorused sound (wet).

R1 DEPTH
Adjusts the ensemble depth.

R2 DELAY TIME
Adds a repeating delay of the Ensemble sound (up to 200mS).

CELESTE

Celeste is a three phase chorus, with each of the three chorus units at a different phase.

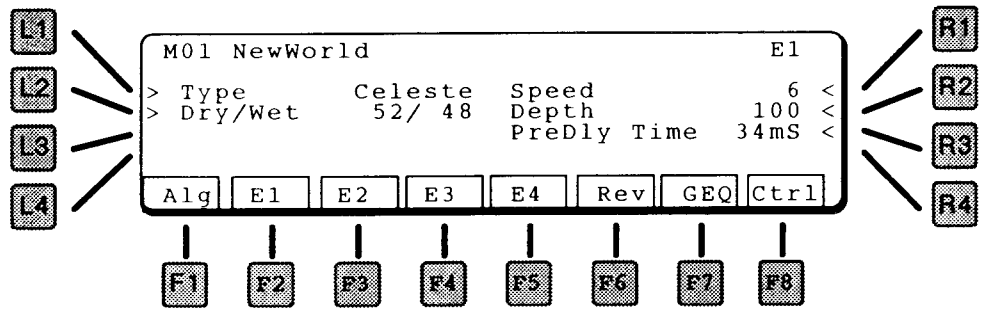

L1 TYPE
Selects the type of effect.

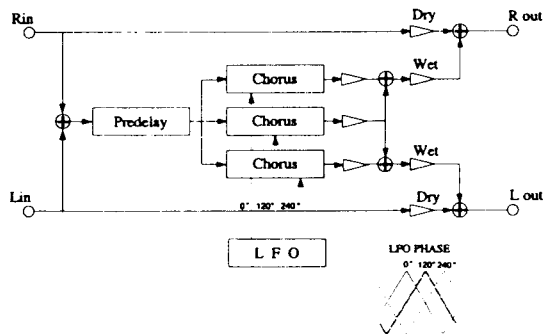

L2 DRY/WET
Controls the ratio between the original (dry) and the chorused sound (wet).

R1 SPEED
Adjusts the ensemble speed.

R2 DEPTH
Controls how wide the detune is.

R3 PREDELAY TIME
Adds a delay (up to 100mS) before the celeste starts.

CELESTE & DELAY

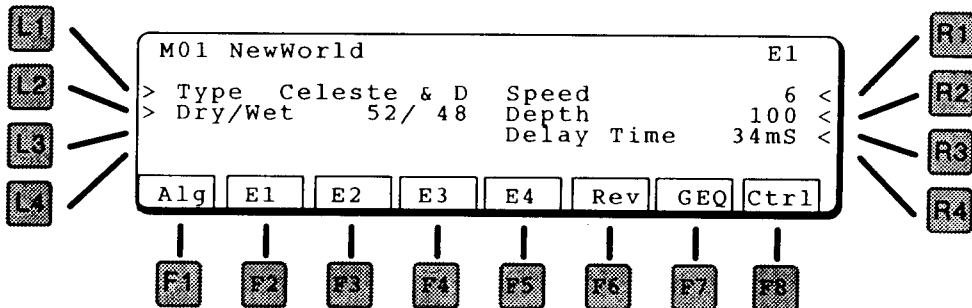

L1 TYPE
Selects the type of effect.

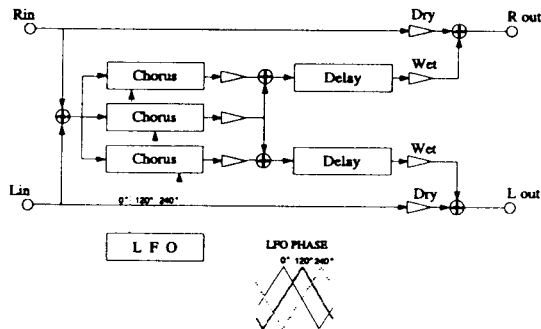

L2 DRY/WET
Controls the ratio between the original (dry) and the chorused sound (wet).

R1 SPEED
Adjusts the ensemble speed.

R2 DEPTH
Controls how wide the detune is.

R3 DELAY TIME
Adds a repeating delay of the Celeste sound (up to 200mS).

TREMOLO

Tremolo changes the volume of the sound, making it louder and softer. Can be used for surf guitar sounds.

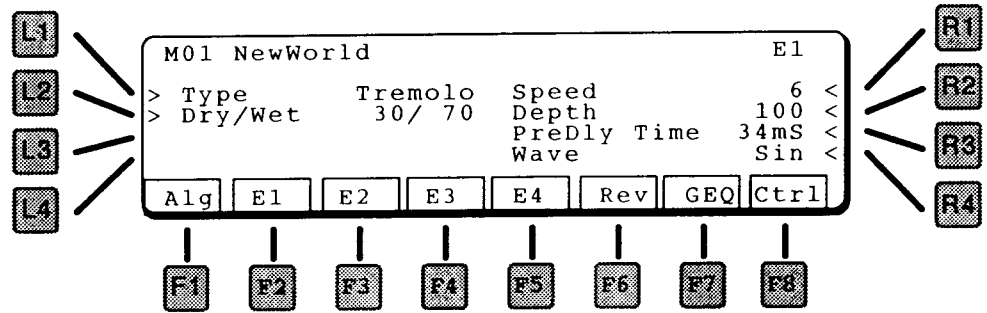

L1 TYPE

Selects the type of effect.

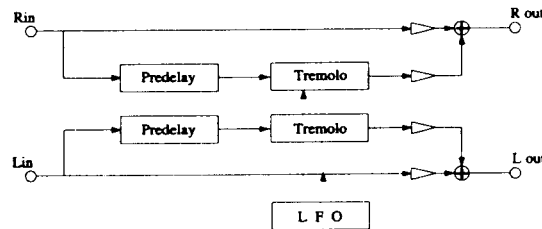

L2 DRY/WET

Controls the ratio between the original (dry) and the tremolo sound (wet).

R1 SPEED

Adjusts the tremolo speed.

R2 DEPTH

Controls how deep the tremolo is.

R3 PREDELAY TIME

Adds a delay (up to 100ms) before the tremolo starts.

R4 WAVE

Selects the LFO waveform used to control the tremolo. The choices are SINE or TRIangle.

TREMOLO & DELAY

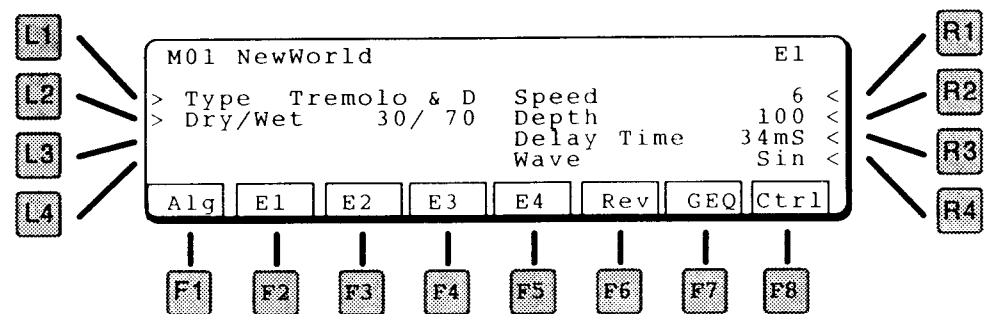

L1 TYPE
Selects the type of effect.

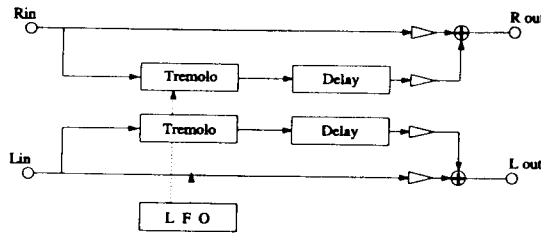

L2 DRY/WET
Controls the ratio between the original (dry) and the tremolo sound (wet).

R1 SPEED
Adjusts the tremolo speed.

R2 DEPTH
Controls how deep the tremolo is.

R3 DELAY TIME
Adds a repeating delay of the tremolo sound (up to 200ms).

R4 WAVE
Selects the LFO waveform used to control the tremolo. The choices are SINE or TRIangle.

PHASER 1 PHASER 2

The phaser creates a phase change in the sound, adding motion to the sound. Good for any sustain sounds, such as strings and organ, as well as for electric pianos and other vintage guitar sounds.

Phaser 1 is a true stereo in / stereo out phase shifter – the left and right channels are independent.

Phaser 2 is a mono in / stereo out phase shifter – the left and right channels are summed together before go into to a stereo phase shifter.

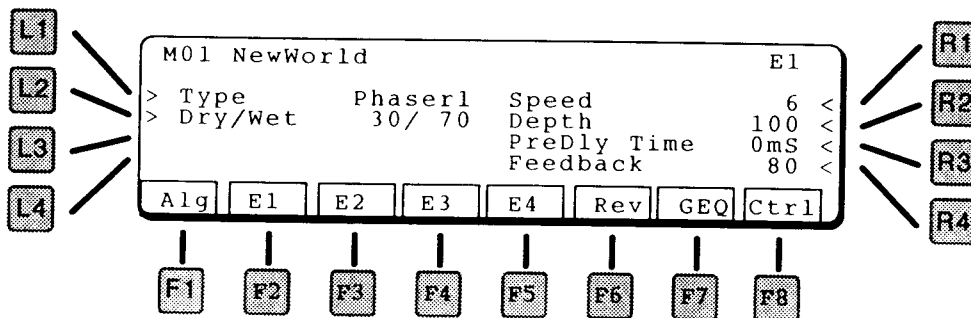

L1 TYPE
Selects the type of effect.

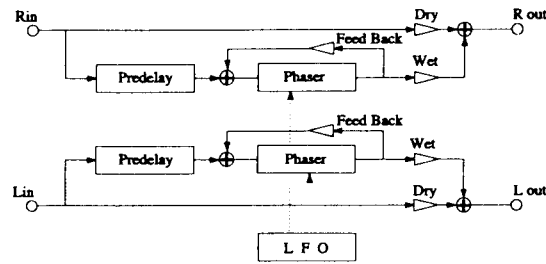

L2 DRY/WET
Controls the ratio between the original (dry) and the phaser sound (wet).

R1 SPEED
Adjusts the phaser speed.

R2 DEPTH
Controls how wide the phasing is.

R3 PREDELAY TIME
Adds a delay (up to 100mS) before the phasing starts.

R4 FEEDBACK
Feeds the sound back into itself, creating a longer sustained sound.

PHASER 1 & DELAY PHASER 2 & DELAY

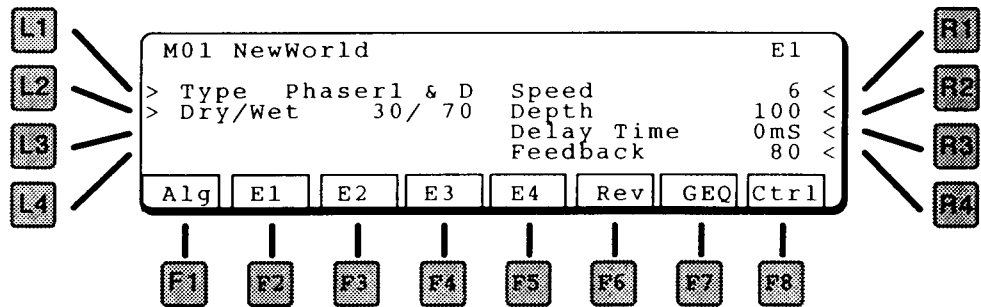

L1 TYPE
Selects the type of effect.

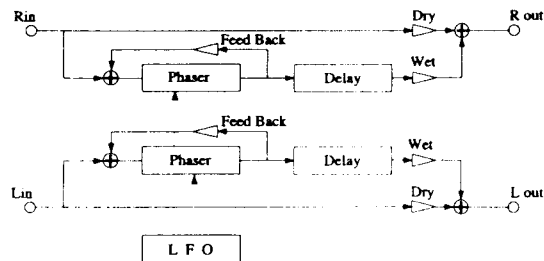

L2 DRY/WET
Controls the ratio between the original (dry) and the phaser sound (wet).

- R1 SPEED**
Adjusts the phaser speed.
- R2 DEPTH**
Controls how wide the phasing is.
- R3 DELAY TIME**
Adds a repeating delay of the phaser sound (up to 200mS).
- R4 FEEDBACK**
Feeds the sound back into itself, creating a longer sustained sound.

ROTARY

This offers a two speed phasing effect, designed to simulate the slow and fast switching of an organ rotary speaker.

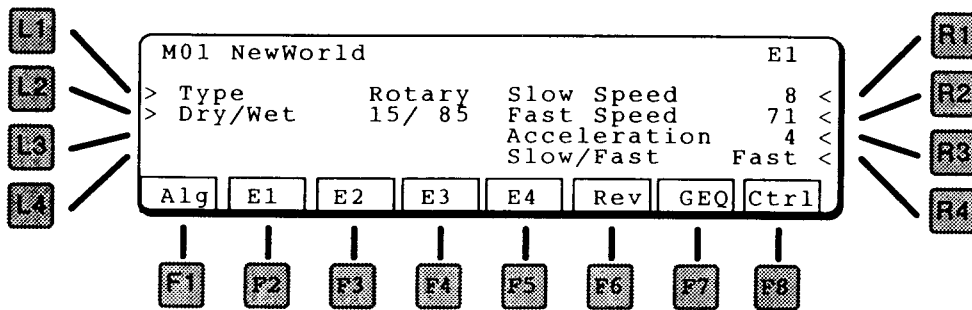

- L1 TYPE**
Selects the type of effect.

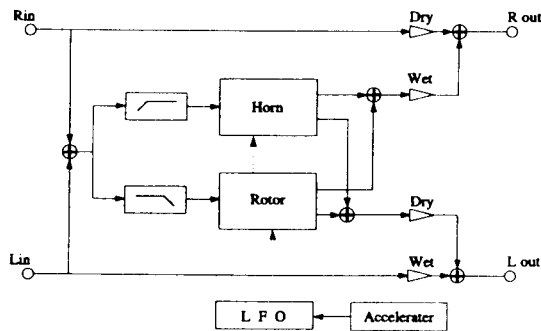

- L2 DRY/WET**
Controls the ratio between the original (dry) and the rotary sound (wet).
- R1 SLOW SPEED**
Adjusts the slow rotary speed.
- R2 FAST SPEED**
Adjusts the fast rotary speed.
- R3 ACCELERATION**
Controls the time it takes to switch from slow to fast or fast to slow.

R4 SLOW/FAST SWITCH

Changes between slow and fast. When this parameter is changed, the rotary changes to the other speed at a rate determined by the Acceleration parameter. You can control this parameter using the Effect Controller, page 63.

AUTO WAH

The Auto Wah sweeps the filter up and down on note attack, simulating a wah wah pedal.

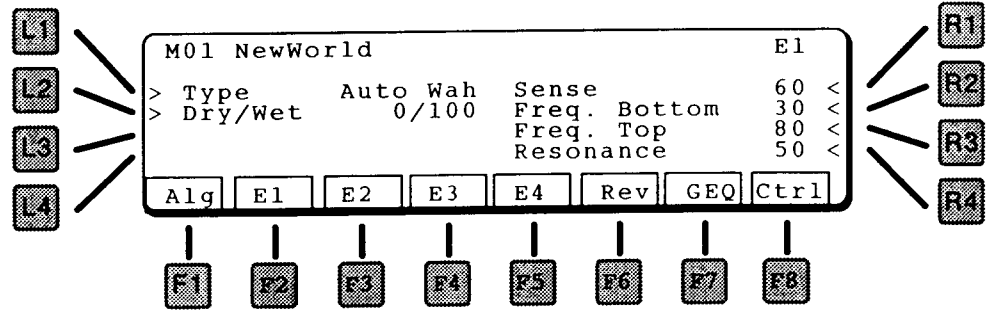

L1 TYPE

Selects the type of effect.

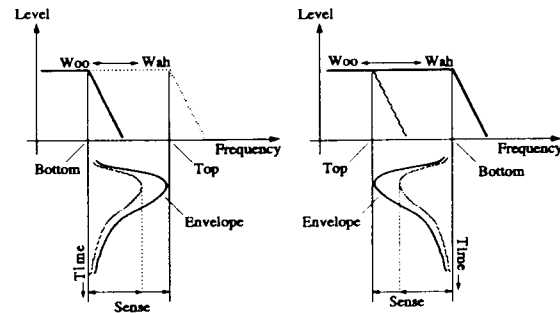
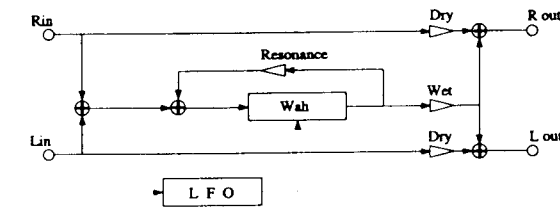

L2 DRY/WET

Controls the ratio between the original (dry) and the wah sound (wet).

R1 SENSE

Adjusts the sensitivity of the wah effect to the key velocity. The harder the note is played, the higher the wah will sweep.

R2 FREQUENCY BOTTOM

Sets the starting and ending filter point.

R3 FREQUENCY TOP

Sets the peak point of the filter sweep.

R4 RESONANCE

Adjusts the filter resonance, for more of a pronounced "wah" effect.

BANDPASS

The Bandpass effect filters out sound above and below the filter point. This can be used to create "telephone" sound, for example, or music playing out of a small radio.

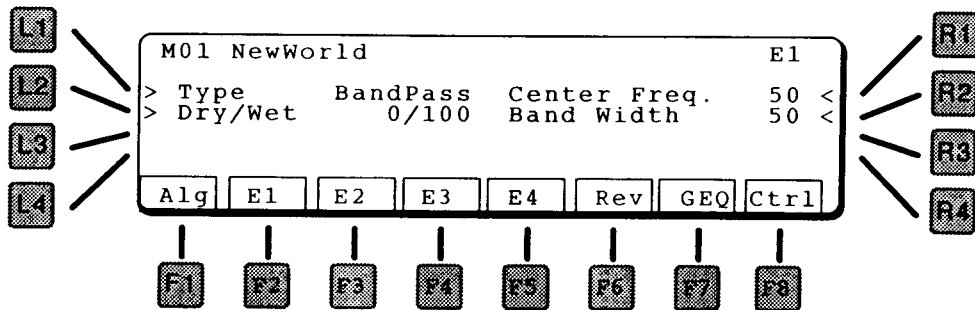

L1 TYPE
Selects the type of effect.

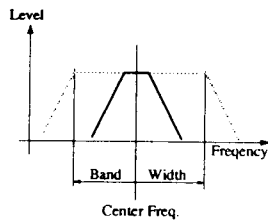
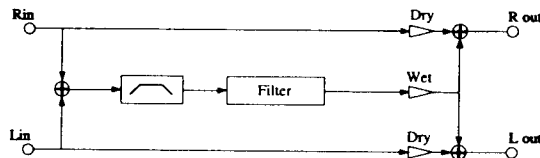

- L2 DRY/WET**
Controls the ratio between the original (dry) and the filtered sound (wet).
- R1 CENTER FREQUENCY**
Adjusts the center point for the bandpass filter.
- R2 BAND WIDTH**
Adjusts how wide the filtering will be on either side of the Center Frequency.

EXCITER

The Exciter emphasizes high frequencies to make a sound more easily discernible in a mix. The exciter uses to distortion to achieve its emphasis.

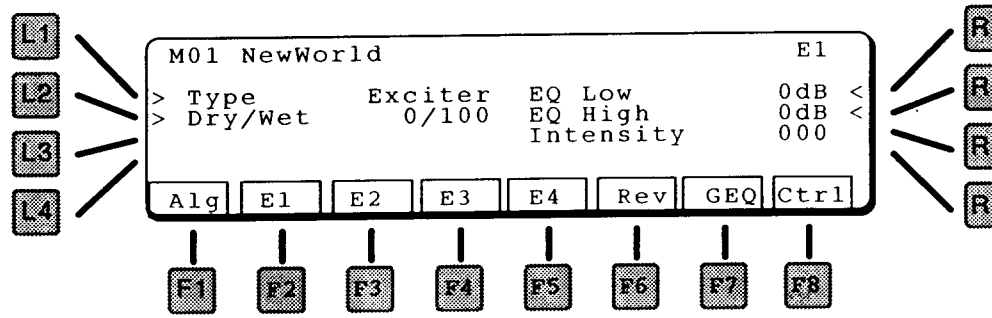

L1 TYPE
Selects the type of effect.

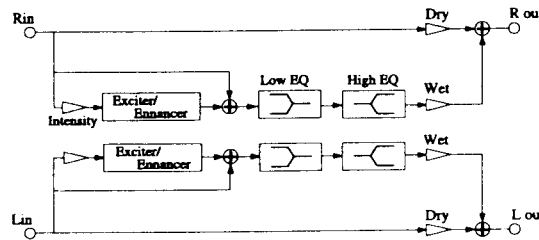

L2 DRY/WET
Controls the ratio between the original (dry) and the excited sound (wet).

R1 EQ LOW
Adjust frequencies below the exciter point.

R2 EQ HIGH
Adjust frequencies above the exciter point.

R3 INTENSITY
Adjusts the amount of exciter effect.

ENHANCER

The Enhancer emphasizes high frequencies to make a sound more easily discernible in a mix. The Enhancer uses to phase shift and filtering to achieve its emphasis.

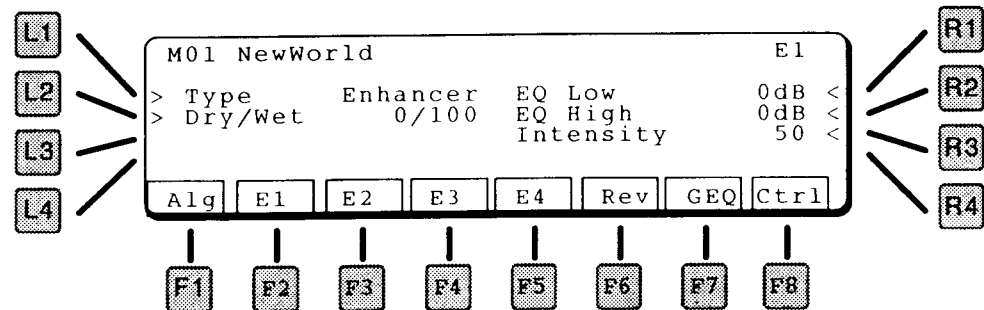

L1 TYPE
Selects the type of effect.

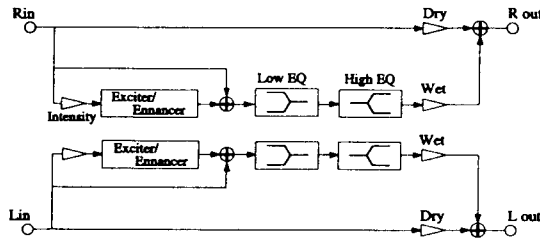

L2 DRY/WET
Controls the ratio between the original (dry) and the enhanced sound (wet).

R1 EQ LOW
Adjust frequencies below the enhanced point.

R2 EQ HIGH
Adjust frequencies above the enhanced point.

R3 INTENSITY
Adjusts the amount of enhancement.

OVERDRIVE

The overdrive effect adds distortion and sustain for electric guitar "fuzz" type sounds. It is a softer type of distortion than the Distortion effect, below.

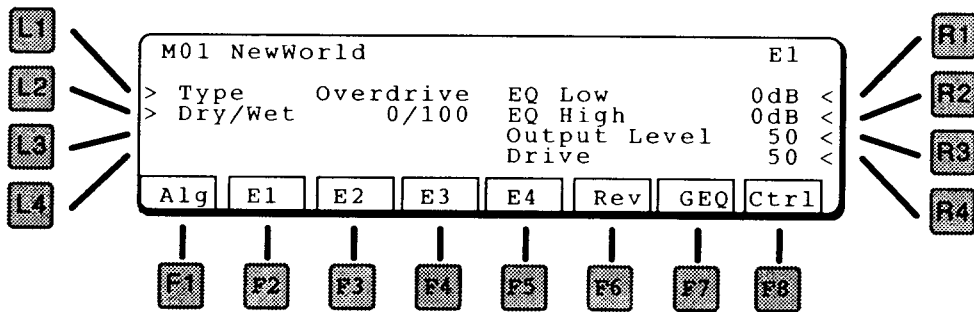

L1 TYPE
Selects the type of effect.

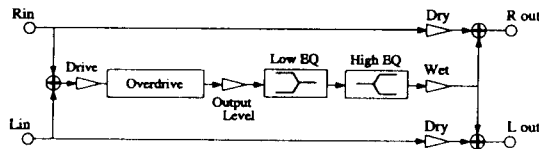

L2 DRY/WET
Controls the ratio between the original (dry) and the distorted sound (wet).

R1 EQ LOW
Adjusts the low frequencies of the overdrive effect.

R2 EQ HIGH
Adjusts the high frequencies of the overdrive effect.

R3 OUTPUT LEVEL
Adjusts the level of the overdrive effect.

R4 DRIVE
Adjusts the amount of distortion.

DISTORTION

The distortion effect adds a harder distortion and sustain for electric guitar "fuzz" type sounds.

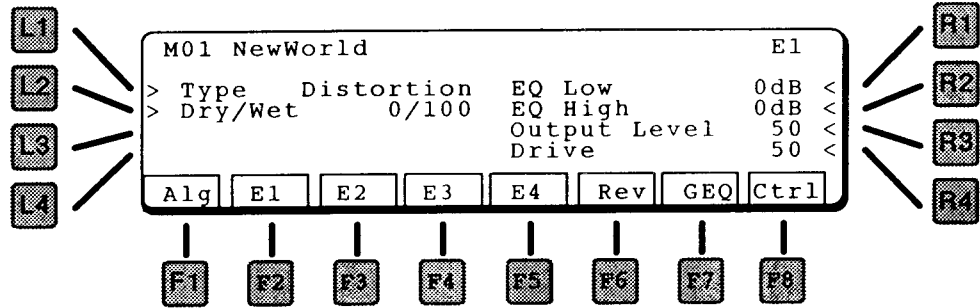

L1 TYPE
Selects the type of effect.

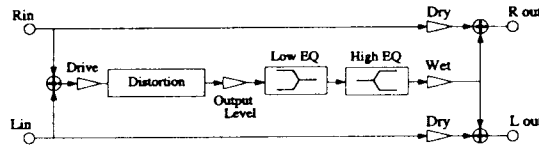

L2 DRY/WET
Controls the ratio between the original (dry) and the distorted sound (wet).

R1 EQ LOW
Adjusts the low frequencies of the distortion effect.

R2 EQ HIGH
Adjusts the high frequencies of the distortion effect.

R3 OUTPUT LEVEL
Adjusts the level of the distortion effect.

R4 DRIVE
Adjusts the amount of distortion.

OVERDRIVE & DELAY

Overdrive & Delay adds a slap echo delay to the overdrive sound. The result is an even longer sustained distortion sound.

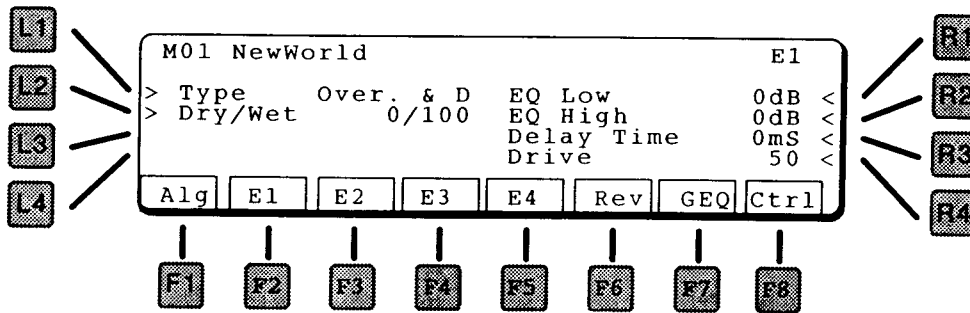

L1 TYPE
Selects the type of effect.

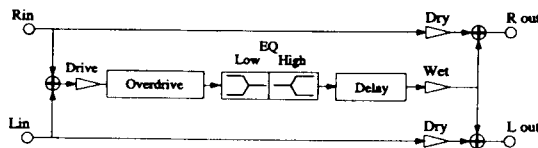

- L2 DRY/WET**
Controls the ratio between the original (dry) and the distorted sound (wet).
- R1 EQ LOW**
Adjusts the low frequencies of the overdrive effect.
- R2 EQ HIGH**
Adjusts the high frequencies of the overdrive effect.
- R3 DELAY TIME**
Adjusts the time of the delay (up to 200mS).
- R4 DRIVE**
Adjusts the amount of distortion.

DISTORTION & DELAY

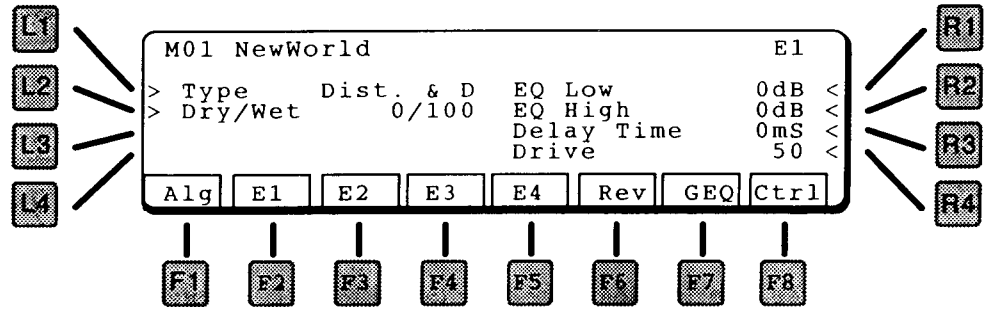

L1 TYPE

Selects the type of effect.

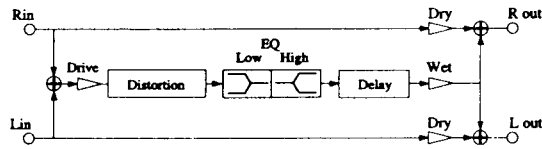

L2 DRY/WET

Controls the ratio between the original (dry) and the distorted sound (wet).

R1 EQ LOW

Adjusts the low frequencies of the overdrive effect.

R2 EQ HIGH

Adjusts the high frequencies of the overdrive effect.

R3 DELAY TIME

Adjusts the time of the delay (up to 200mS).

R4 DRIVE

Adjusts the amount of distortion.

REVERB TYPES

Rev

The Reverb block represents reverberation effects. Any of eleven different reverb types can be assigned, which include a variety of rooms, halls, and plates. The available controls vary from one effect to another.

As can be seen from the block diagram, there are two inputs to the reverb section. Each reverb screen has a pair of Wet/Dry parameters, one for each input. These two *reverb sends* allow you to adjust the reverb balance for each input independently.

- HALL 1
- HALL 2
- HALL 3

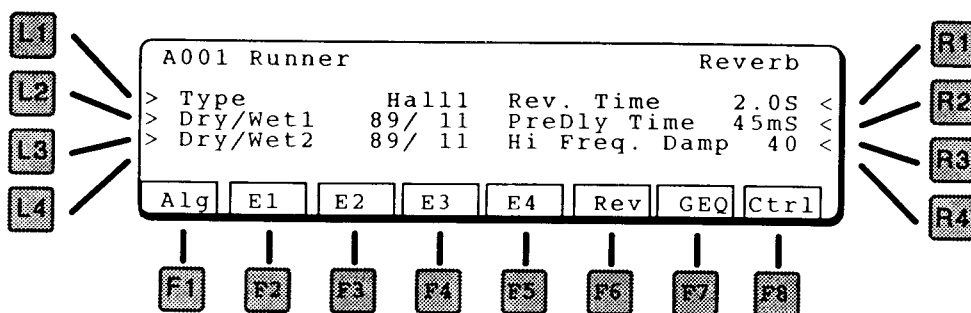

L1 TYPE
Selects the type of effect.

HALL 1
Standard Hall

HALL 2
Small Hall

HALL 3
Bright Hall

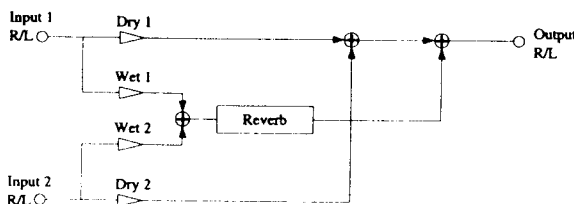

L2 DRY/WET 1
Controls the ratio between the original sound (dry) and the reverberated sound (wet) for the *top input* in the algorithm.

L3 DRY/WET 2

Controls the ratio between the original sound (dry) and the effected sound (wet) for the *bottom input* in the algorithm.

R1 REVERB TIME

Total reverberation time, in seconds.

R2 PREDELAY TIME

The amount of delay time before the effect.

R3 HIGH FREQUENCY DAMPING

In most natural acoustic spaces, high frequencies are absorbed faster than low frequencies. High Frequency Damping simulates this phenomenon by causing the high frequencies to die out faster. The more damping, the faster they die out – and sounds like there is more carpet or drapes in the room. Concrete room? Set the damping to 1.

ROOM 1

ROOM 2

ROOM 3

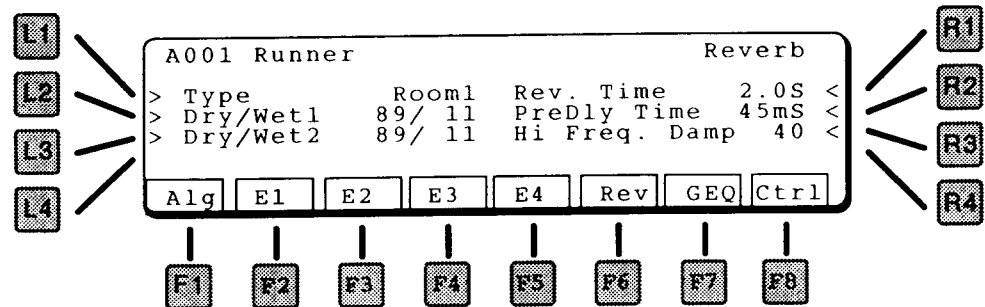

L1 TYPE

Selects the type of effect.

ROOM 1
Standard Room

ROOM 2
Large Room

ROOM 3
Bright Room

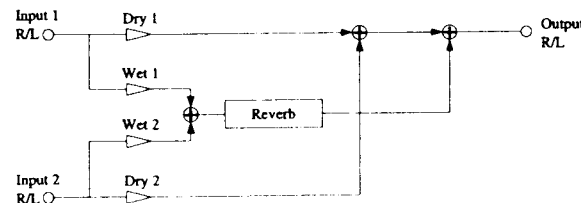

L2 DRY/WET 1

Controls the ratio between the original sound (dry) and the reverberated sound (wet) for the *top input* in the algorithm.

- L3 DRY/WET 2**
Controls the ratio between the original sound (dry) and the effected sound (wet) for the *bottom input* in the algorithm.
- R1 REVERB TIME**
Total reverberation time, in seconds.
- R2 PREDELAY TIME**
The amount of delay time before the effect.
- R3 HIGH FREQUENCY DAMPING**
In most natural acoustic spaces, high frequencies are absorbed faster than low frequencies. High Frequency Damping simulates this phenomenon by causing the high frequencies to die out faster.

PLATE 1
PLATE 2
PLATE 3

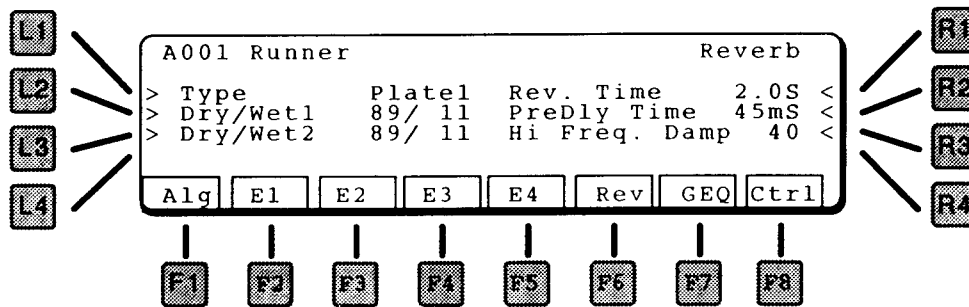

- L1 TYPE**
Selects the type of effect.

PLATE 1
Large Plate

PLATE 2
Small Plate

PLATE 3
Mellow Plate

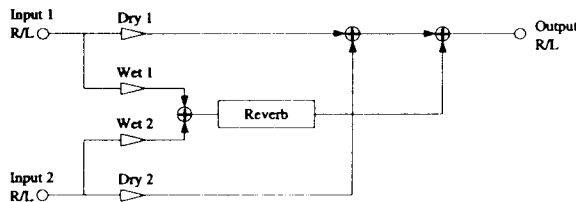

- L2 DRY/WET 1**
Controls the ratio between the original sound (dry) and the reverberated sound (wet) for the *top input* in the algorithm.
- L3 DRY/WET 2**
Controls the ratio between the original sound (dry) and the effected sound (wet) for the *bottom input* in the algorithm.

R1 REVERB TIME

Total reverberation time, in seconds.

R2 PREDELAY TIME

The amount of delay time before the effect.

R3 HIGH FREQUENCY DAMPING

In most natural acoustic spaces, high frequencies are absorbed faster than low frequencies. High Frequency Damping simulates this phenomenon by causing the high frequencies to die out faster.

REVERSE

Instead of decaying as natural reverb does, reverse reverb builds up as shown in the diagram below.

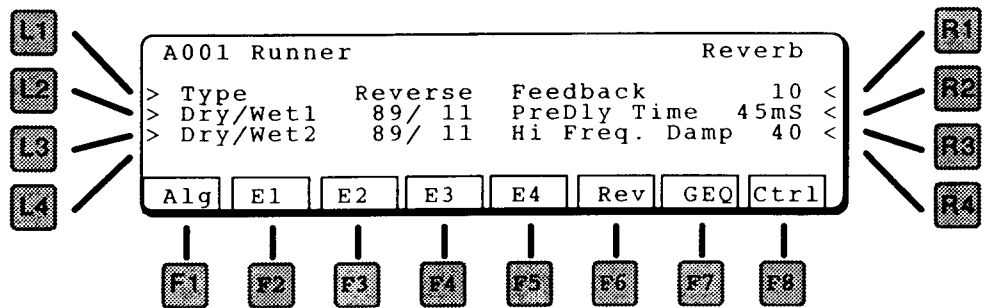
**L1 TYPE**

Selects the type of effect.

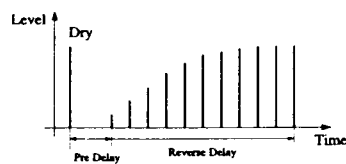
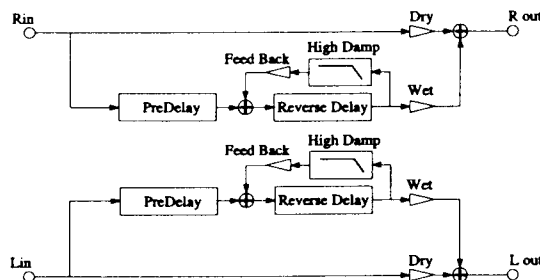
**L2 DRY/WET 1**

Controls the ratio between the original sound (dry) and the reverberated sound (wet) for the *top input* in the algorithm.

L3 DRY/WET 2

Controls the ratio between the original sound (dry) and the effected sound (wet) for the *bottom input* in the algorithm.

R1 FEEDBACK

Amount of delay looped back into the input. This creates a repeating delay.

- R2 PREDELAY TIME**
The amount of delay time before the effect.
- R3 HIGH FREQUENCY DAMPING**
Attenuates high frequencies from each repeat.

LONG DELAY

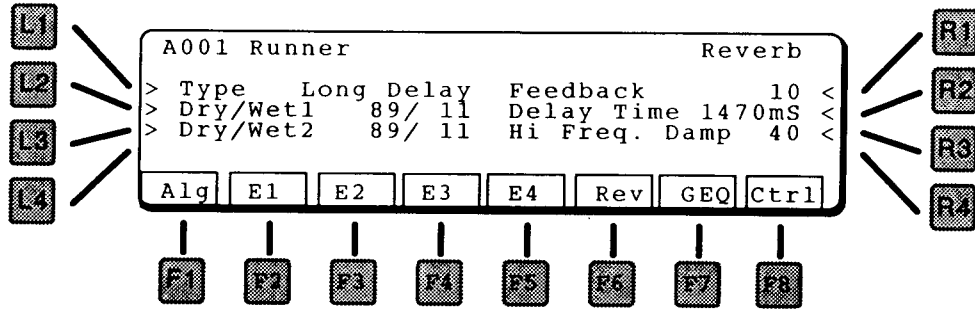

- L1 TYPE**
Selects the type of effect.

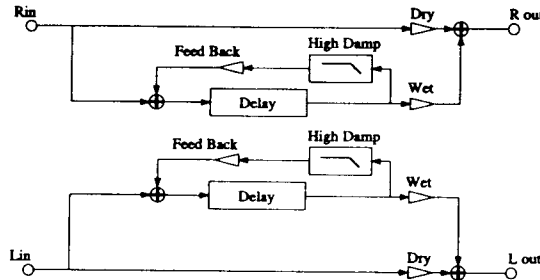

- L2 DRY/WET 1**
Controls the ratio between the original sound (dry) and the delayed sound (wet) for the *top* input in the algorithm.
- L3 DRY/WET 2**
Controls the ratio between the original sound (dry) and the delayed sound (wet) for the *bottom* input in the algorithm.
- R1 FEEDBACK**
Amount of delay looped back into the input. This creates a repeating delay.
- R2 DELAY TIME**
Adjusts the delay time in 10mS increments, from 200 - 1470 mS. (1.47 seconds)
- R3 HIGH FREQUENCY DAMPING**
Attenuates high frequencies from each repeat.

MULTI SECTION

Multi Patches are *combinations* of up to four Single patches. They can be arranged in layers, key splits, velocity splits, multiple channels or any combination.

MULTI PLAY

Pressing the Multi key on the right side of the keyboard brings up the Multi Play window.

M07		Moonrise					
Chimera	1	Runner	2	SynStrg1	3	GOOM	4
1ch	↑	1ch	↑	1ch	↑	1ch	↑
0	96	-12	97	0	104	0	120
Trns	Vol	Trns	Vol	Trns	Vol	Trns	Vol

The name of the Multi patch is displayed as well as the name, MIDI channel, transpose, and volume for each Single patch that it contains.

SELECTING MULTI PATCHES

To select one of the 64 Multi patches, use the Patch Select keys 0 through 9 on the right side of the panel. To change banks, use the Patch Select keys 00 through 06. The Bank menu screen appears as shown below.

Multi Bank Menu	
M10	Komradds
M11	Addalogg
M12	Addalog2
M13	CashFlow
M14	WINBRASS
M15	E-Normus
M16	Raunch
M17	TakeOver
M18	Frostbyt
M19	Wilder

This screen lists the patches in the selected bank. To select one press the 0-9 key corresponding to the last digit of the patch number. A different patch will play, with the display as shown at the top of this section.

MODIFYING MULTI PATCHES

In Multi Play mode, the transposition and volume of each single patch can be adjusted. Press one of the F keys as described below, then use the value dial to change the setting.

M07		Moonrise					
Chimera	1	Runner	2	SynStrg1	3	GOOM	4
1ch	↑	1ch	↑	1ch	↑	1ch	↑
0	96	-12	97	0	104	0	120
Trns	Vol	Trns	Vol	Trns	Vol	Trns	Vol
F1	F2	F3	F4	F5	F6	F7	F8

F1 TRANSPOSE SECTION 1

This parameter adjusts the pitch of Section 1, in semitones. To raise a sound one octave, set the transpose to 12; to lower it one octave, set the transpose to -12.

- F2 VOLUME SECTION 1**
This parameter adjusts the volume of Section 1.
- F3 TRANSPOSE SECTION 2**
This parameter adjusts the pitch of Section 2, in semitones.
- F4 VOLUME SECTION 2**
This parameter adjusts the volume of Section 2.
- F5 TRANSPOSE SECTION 3**
This parameter adjusts the pitch of Section 3, in semitones.
- F6 VOLUME SECTION 3**
This parameter adjusts the volume of Section 3.
- F7 TRANSPOSE SECTION 4**
This parameter adjusts the pitch of Section 4, in semitones.
- F8 VOLUME SECTION 4**
This parameter adjusts the volume of Section 4.

USING THE MACRO CONTROLS

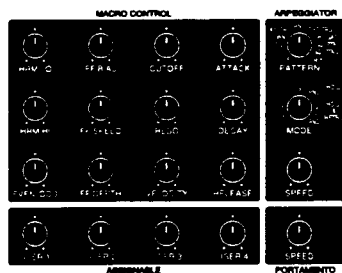

As in Single mode, the Macro and Assignable Controls on the left of the instrument are also available for instant edit in Multi mode. These controls are described on page 23. *They affect only the selected Single patch (and others on the same MIDI channel), and add and subtract from the original values contained in each Single patch.*

The arpeggiator settings also only affect the selected Single patch, and others on the same MIDI channel.

MULTI EDIT

Pressing EDIT brings up the Multi Edit Menu, below.

```
M21 K-Hit!                                     Menu
> Common
> Section
> Effect
```

L1 COMMON

This jumps to the Common edit, below.

L2 SECTION

This jumps to Section edit, discussed on the next page.

L3 EFFECT

Jumps to the Effect section, page 61.

NOTE:

Press EXIT to return to the Multi Edit Menu.

EXITING EDIT MODE

From the Multi Edit Menu, press EXIT. An alert message appears, asking if you want to "Save and Quit". Press WRITE to save and quit to Multi Play mode, or F8 (Quit) to return to Multi Play mode without saving. To continue editing, press EDIT.

COMMON

Enter the name of the Multi patch from this page.

```
M21 K-Hit!                                     Common
> -> Name K-Hit!
> <-
! "# $ % & ' ( ) * + , - . / 0 1 2 3 4 5 6 7 8 9 : ; < = > ?
@ A B C D E F G H I J K L M N O P Q R S T U V W X Y Z [ ] ^ _
` a b c d e f g h i j k l m n o p q r s t u v w x y z { | } ~
More
```

L1 and L2 select which character is selected, the Value dial selects the desired letter or number.

F8 MORE

This advances to the Volume page.

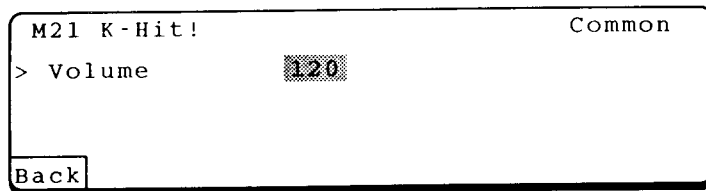

L1 VOLUME

This sets the master volume for the Multi patch.

F1 BACK

This returns to the Name page.

SECTION

The Section pages contain parameters to setup each of the four sections of a Multi Patch.

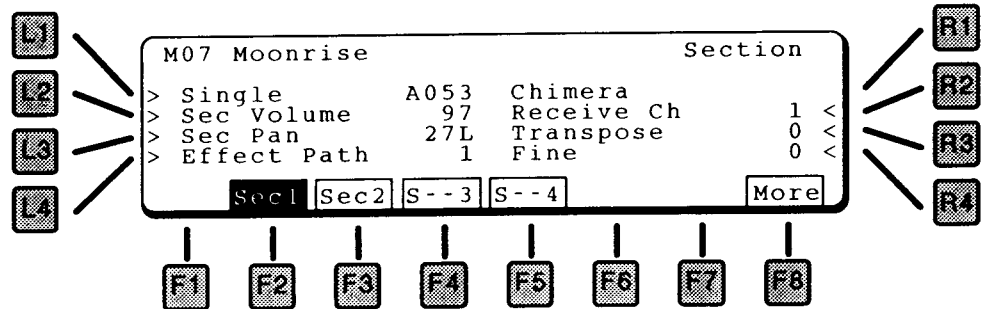

SELECTING A SECTION

The Section parameters are duplicated for each section in a Multi patch. To select a section, press the function key for the desired section (F2 – F5). In the display above, Section 1 is selected.

ENABLING / MUTING SECTIONS

Turning individual sections on and off is useful for editing. In addition, many Multi patches do not need all four sections enabled.

With the desired section selected (highlighted), press the section function key again (F2 – F5). The Section will turn on or off each time the function button is pressed.

In the display above, Sections 1 and 2 are enabled (**Sec1**), Sections 3 and 4 are muted (**S--4**). The "ec" changes to "--" when a section is muted.

SECTION MENU FUNCTIONS

L1 SINGLE PATCH

Selects the Single patch for this section.

L2 SECTION VOLUME

Adjusts the volume for the section.

L3 SECTION PAN
Adjusts the stereo pan for the section.

L4 EFFECT PATH
Routes this section to one of the four inputs of the effects section. For more on the Effects, please see page !!!.

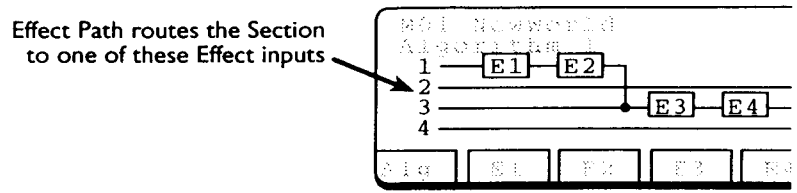

R2 SECTION CHANNEL
Sets the MIDI receive channel for the section. By setting each section to a different channel, the K5000S can play upto four independent parts when controlled from an external sequencer or computer.

R3 TRANSPOSE
Adjusts the transposition of the selected section, in semitone increments. A transposition of +12 is one octave higher.

R4 FINE
Adjusts the tuning of the section.

F8 MORE
Jumps to the Zone screen, below.

SECTION KEY AND VELOCITY ZONES

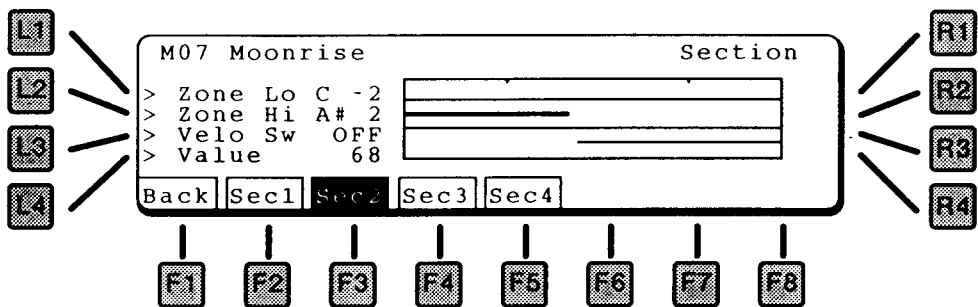

L1 ZONE LO
Sets the lowest note that will be played. The keyboard graphic visually shows the range. The selected section is highlighted.

L2 ZONE HI
Sets the highest note that will be played.

R1 VELOCITY SWITCH
Sets the velocity range. At Loud, only hard (loud) notes will sound. At Soft, only soft notes will sound. When set to OFF, the velocity switch is turned off and notes play at all velocity levels.

R2 VALUE
Sets the threshold between high and low velocity. This is the MIDI velocity number.

F1 BACK
Press to return to the previous screen.

WRITE

After editing, save your Multi by pressing the WRITE button in the COMMON section of the front panel. The following screen appears.

```
M07 Moonrise
> Write
```

L1 WRITE

This saves your patch to the internal memory area.

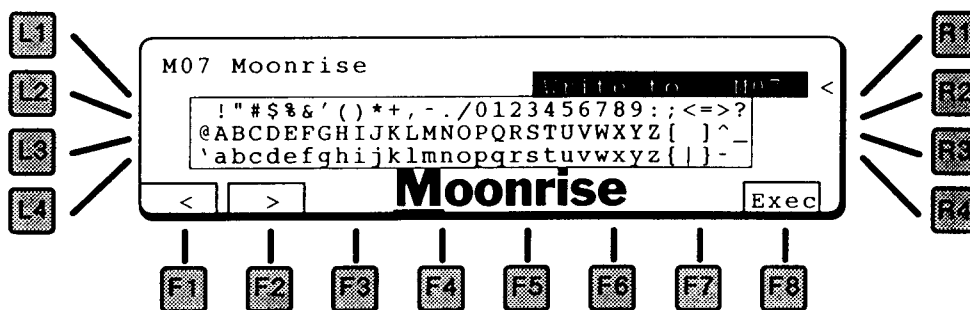

R1 WRITE LOCATION

Use the Value dial to select a location to save your patch.

F1/F2 CHARACTER

This names the patch. Use the F1 and F2 keys to select a character in the name (moves the cursor), and the Value dial to select a letter.

F8 EXECUTE

Stores the patch.

COMMON

The Common area of the front panel, to the left of the LCD, contains controls for parameters that concern the entire instrument.

SYSTEM SECTION

The System pages offer preference settings, that control the general behavior of the K5000S.

The seven Function keys (F1 – F7) jump between the seven sections of the System parameters.

- F1 FSW**
Goes to the Switch page.
- F2 ARPEGGIATOR**
Goes to the Arpeggiator page.
- F3 RESET**
Goes to the reset page.
- F4 BACKUP**
Goes to the Backup page.
- F5 MIDI**
Goes to the System MIDI page.
- F6 SYSTEM**
Goes back to the main System page, below.
- F7 DUMP**
Goes to the MIDI Data Dump page.

SYSTEM

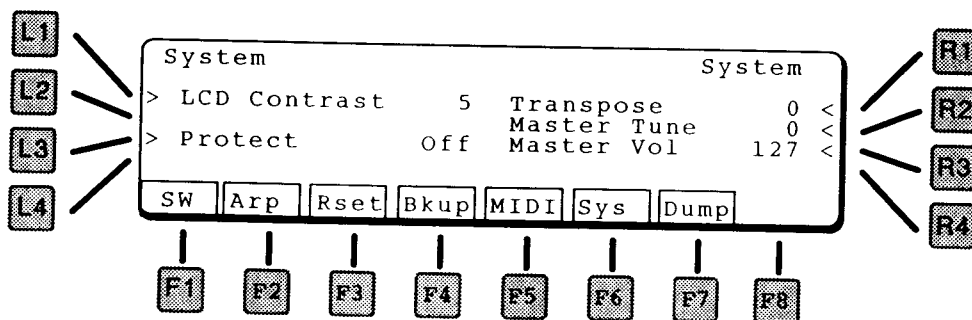

- L1 LCD CONTRAST**
This adjusts the contrast of the LCD display. Adjust it so the display can be seen clearly.
- L3 PROTECT**
This turns on the memory protect for the internal program memory. When Protect is on, sound programs can not be saved to internal memory.
- R1 TRANSPOSE**
Master Transpose for the instrument.

R2 MASTER TUNE
Master Tune for the instrument.

R3 MASTER VOLUME
This sets the MIDI master volume for the instrument, MIDI controller 7.

FSW (PROGRAMMABLE SWITCHES)

On this page, the functions of the programmable switches (under the disk drive) and programmable footswitch jacks (on the rear panel) can be set.

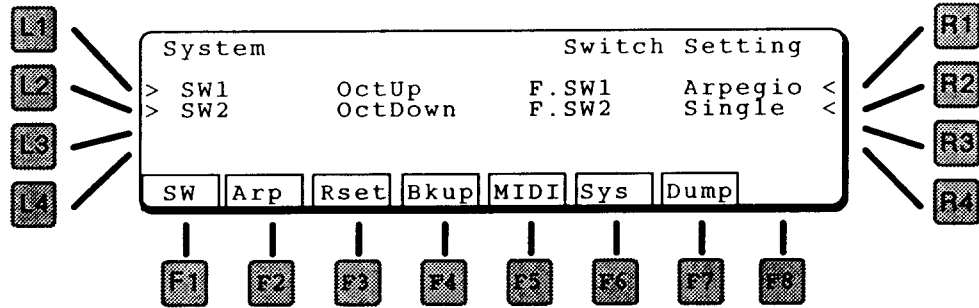

THE AVAILABLE SETTINGS ARE:

SINGLE

Set by Single Patch parameters, see page 27.

ARPEGGIO

Turns the arpeggiator on and off, same as the Arpeggiator button on the front panel.

OCTUP

Transposes the keyboard up an octave.

OCTDOWN

Transposes the keyboard down an octave.

L1 SWITCH1

Selects the function for Switch 1.

L2 SWITCH2

Selects the function for Switch 2.

R1 FOOTSWITCH1

Selects the function for Footswitch 1.

R2 FOOTSWITCH2

Selects the function for Footswitch 2.

ARPEGGIATOR

One of the unique features of the K5000S is its programmable Arpeggiator, which allows a sophisticated level of programming.

COMMON PARAMETERS

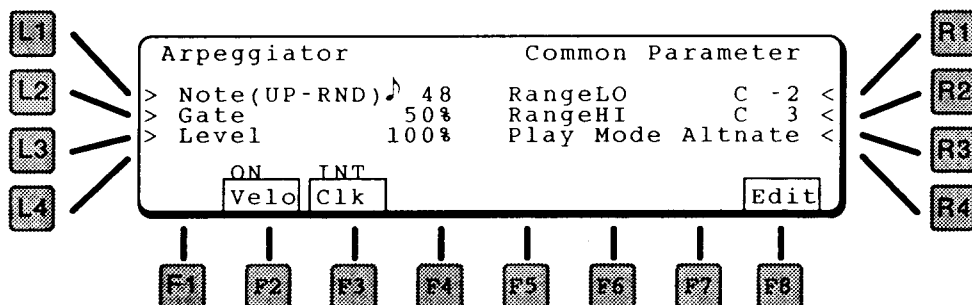

L1 NOTE VALUE

This sets the note value for the arpeggiator when in Up, Down, Up/Down, Key Order, and Random modes – quarter, eighth, sixteenth notes, etc. The settings are based on a clock resolution of 96 pulses per quarter note. This results in the following possible settings:

♪	96	Quarter Note
♪	64	Quarter Note Triplet
♪	48	Eighth Note
♪	32	Eighth Note Triplet
♪	24	Sixteenth Note
♪	16	Sixteenth Note Triplet
♪	12	Thirty-second note

L2 GATE

This sets the duration of each note as a percentage of arpeggio time. At 100%, each note will be gated up to the start of the next note. At 50%, the gate duration will be half of the time to the next arpeggio note.

L3 LEVEL

This sets the level of each note as a percentage of the keyed velocity.

R1 RANGE LO

Sets the low note of the arpeggiator range. For example, you can set the lowest two octaves for the arpeggiator, then play over the arpeggio with the rest of the keyboard.

R2 RANGE HI

Sets the high note of the arpeggiator range.

R3 PLAY MODE

The Sequence Pattern settings (SQ.PTN1, SQ.PTN2) have a programmed number of “arpeggio positions”. This parameter determines what happens if there are fewer notes to arpeggiate than positions.

REST

The extra positions are filled with rests.

LAST

The last note repeats to fill the extra positions.

FIRST

The first note repeats to fill the extra positions.

ALTERNATE

The played notes are repeated in reverse order to fill the extra positions. If the repeated notes go back all the way to the beginning, more notes will be repeated again, this time from the beginning.

F2 VELOCITY

This turns on velocity sensitivity for the arpeggiator. If On each note will play according to key velocity. If Off all notes will play at the same velocity.

F3 CLOCK

This sets the arpeggiator clock source. If set to EXT, the arpeggiator will advance in time with an external sequencer or computer.

ARPEGGIATOR EDIT

In the next two pages you can program your own arpeggio patterns. You can adjust timing, level, and gate time, to create a rhythmic sequence pattern – you select notes by playing the keyboard.

There are eight user arpeggiator patterns – select one for playback from the Single Play screen using the Value dial, see page 23.

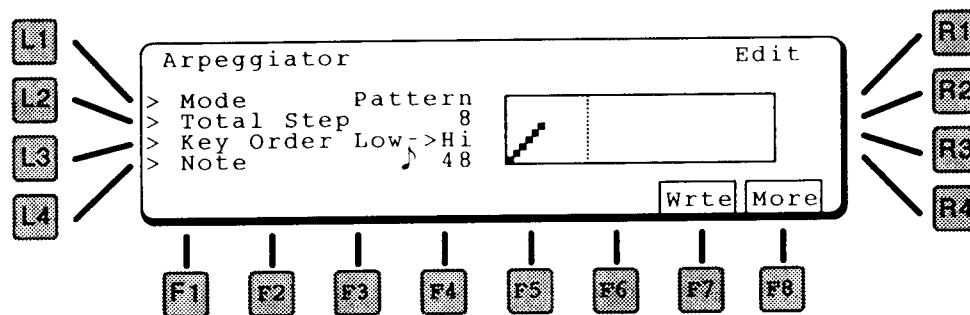

L1 MODE

There are three playback modes:

PATTERN

Notes play one at a time, with velocity controlled by the keyboard and note length (timing) controlled by the arpeggiator. You can program up to four part harmony on each step.

TRIGGER

All notes play together according to the programmed pattern. You can program velocity and timing.

GATER

You can program the volume level and length for each step, creating a rhythmic character to the chord.

L2 TOTAL STEP

This is the number of steps in the pattern. If fewer notes are played, the pattern will either insert rests or repeat notes according to the setting on the Edit Pattern page.

L3 KEY ORDER

KEY ON

Notes are arpeggiated in the order in which they are played on the keyboard.

LOW->HI

Notes are arpeggiated from low to high pitch.

L4 NOTE

This sets the note value for the arpeggiator when in Up, Down, and Random modes – quarter, eighth, sixteenth notes, etc. The settings are based on a clock resolution of 96 pulses per quarter note. This results in the following possible settings:

- ♪ 96 Quarter Note
- ♪ 64 Quarter Note Triplet
- ♪ 48 Eighth Note
- ♪₃ 32 Eighth Note Triplet
- ♪ 24 Sixteenth Note
- ♪₃ 16 Sixteenth Note Triplet
- ♪ 12 Thirty-second note

F7 WRITE

Writes the arpeggio settings to memory. The following dialog box appears:

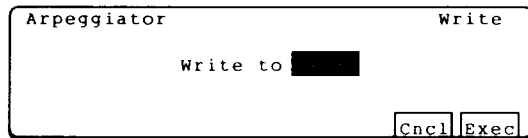

Choose one of the eight arpeggio memory locations using the Value dial. Press Exec to continue.

Are you sure? Press F8 to continue, F1 to cancel.

NOTE:

If you exit the arpeggiator without saving, you will be prompted to save the arpeggio settings.



Press F1 to discard your changes, F8 to go to the Write screen above.

F8 MORE

Goes to the arpeggio pattern editor, below.

ARPEGGIO PATTERN EDIT

On this screen you can edit the arpeggio pattern itself.

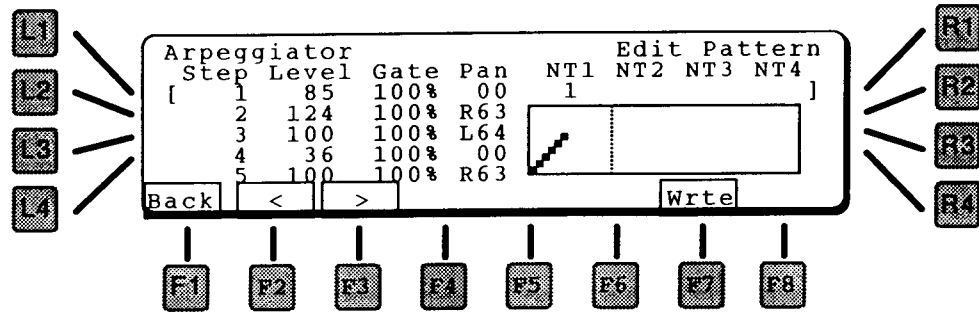

Use the arrow keys (F2 & F3) to navigate left to right in the parameter list.

STEP

This is the step number of the pattern, 1 to a maximum of 32. With Step highlighted, turn the value dial to navigate through the steps in the pattern.

DIFFERENTIATING NOTES AND STEPS

When you play a chord on the keyboard, each note is assigned a number – from bottom to top, or in the order played. These note numbers normally correspond exactly with the step numbers – the arpeggiated sequence, to give the typical ascending note arpeggiator effect.

However, the K5000S arpeggiator does not have to maintain this correspondence, as explained below. You can arrange the notes in any combination you want – which gives you the ability to preprogram a sequence pattern and then control it live from the keyboard.

LEVEL

The level of the note to be played on this step.

REST

If the Level is turned all the way down, REST appears and a rest is applied to this step.

REPEAT

If the Level is turned all the way up, REP appears and the arpeggio repeats from the start to this point, as many times as necessary up to the Total Step duration of the arpeggio.

NOTE:

Repeat cannot be select for the first step of the arpeggio.

GATE

This sets the duration of the note as a percentage of arpeggio time. At 100%, the note will be gated up to the start of the next note. At 50%, the gate duration will be half of the time to the next note.

PAN

This sets the panning of the selected note step. If the Pan is turned down all the way, "---" appears and no panning is applied.

NT1 ~ NT4 (NOTE 1 ~ NOTE 4)

These parameters control which note(s) play on each step.

Up to four notes can actually play on each step – this is where the note vs. step issue becomes important. Normally the NT1 parameter has the same value as the Step Number.

For example, if you wanted to maintain a continuous bass not underneath the rest of the arpeggio, you would set NT1 to 1 on *every* step, then set NT2 equal to the step number on each step. The result: a two voice arpeggio with one voice playing all the notes, the other playing only the lowest (or first) note.

F7 WRITE

Saves the arpeggio settings. There are eight user arpeggio memories. Choose the desired memory location using the Value dial, then press F8 to execute.

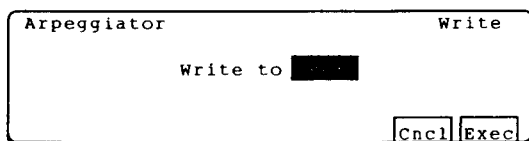

Are you sure? Press F8 to continue, F1 to cancel.

NOTE:

If you exit the arpeggiator without saving, you will be prompted to save the arpeggio settings.



Press F1 to discard your changes, F8 to go to the Write screen above.

RESET

This function reloads all patches from the backup Flash memory. This would only be necessary to restore original patches after receiving a MIDI data dump or playing a MIDI sequence with recorded MIDI patch data.

BACKUP

This function saves all patches in memory to the backup Flash memory area. This is only necessary to save a MIDI data dump, since the patch dump data is written to the working RAM memory only.

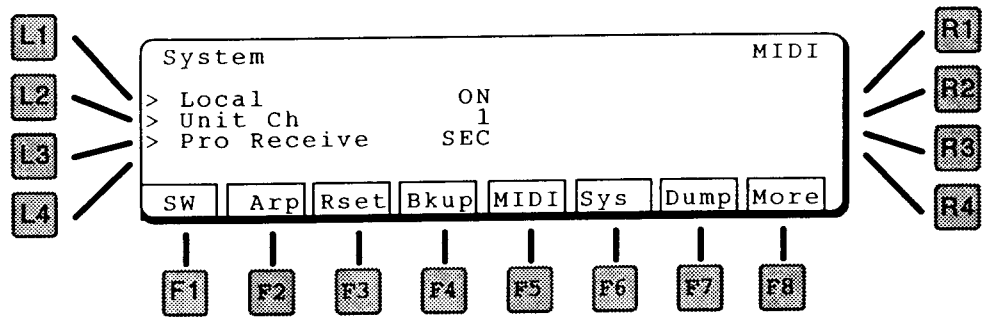

L1 LOCAL

Sets MIDI Local Control. If ON the keyboard and sequencer are attached to the sound generator. If off, the keyboard/sequencer and sound module are separated. Turning off local control is useful when an external MIDI sequencer is used.

L2 UNIT CHANNEL (SYSTEM CHANNEL)

This sets the basic MIDI channel for the unit. This is the channel that will be transmitted by the keyboard, and the channel on which Normal program changes will be received.

L3 PROGRAM RECEIVE

Sets the mode for receiving program changes.

NORMAL

A received program change message causes the instrument to change patches.

SECTION

Within a Multi patch, a received program change message changes only the Single patch assigned to that channel.

F8 MORE

Goes to the next page of parameters.

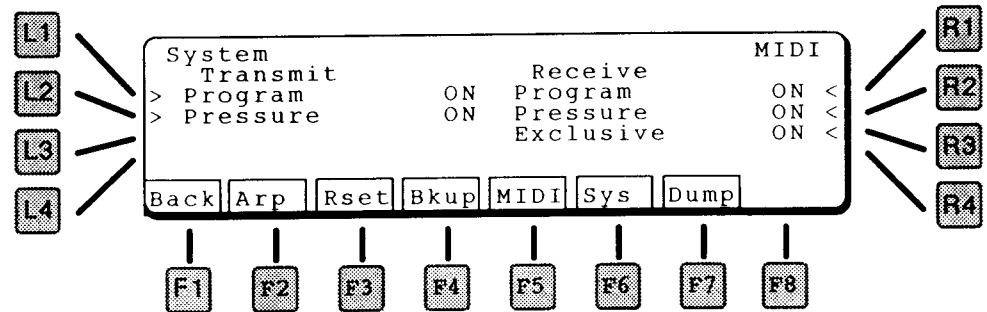

L1 TRANSMIT PROGRAM

If on, the K5000S will transmit program changes.

L2 TRANSMIT PRESSURE

If on, the K5000S will transmit aftertouch pressure.

R1 RECEIVE PROGRAM

If on, the K5000S will receive program changes.

R2 RECEIVE PRESSURE

If on, the K5000S will receive aftertouch pressure.

R3 RECEIVE EXCLUSIVE

If on, the K5000S will receive system exclusive messages.

DUMP

This page is used to initiate a MIDI System Exclusive file transfer. The program data is transmitted across MIDI.

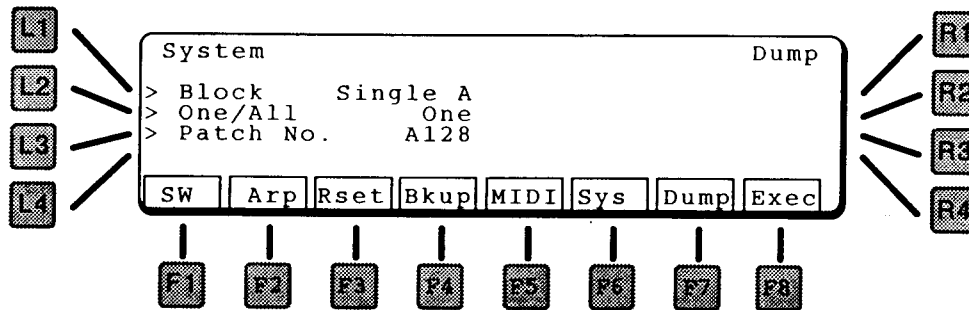

L1 BLOCK

Selects which sound block to transfer.

BLOCKS

SINGLE

A Single sound bank (A or D).

MULTI

Multi combination sound bank

L2 ONE/ALL

Selects a single program or all the programs in the selected block.

L3 PATCH NUMBER

If One is selected above, this parameter selects the individual patch to dump.

F8 EXECUTE

Initiates the data transfer. *Are You Sure?* Press YES (F8) to start, NO (F1) to cancel.

DISK SECTION

The Disk pages enable you to save your work on floppy disks. Whether to backup your patches, save a song for a studio date, load new sounds for another project, you'll find the K5000S's disk is your gateway to the outside world.

Pressing DISK on the front panel brings up the Disk Menu screen, below.

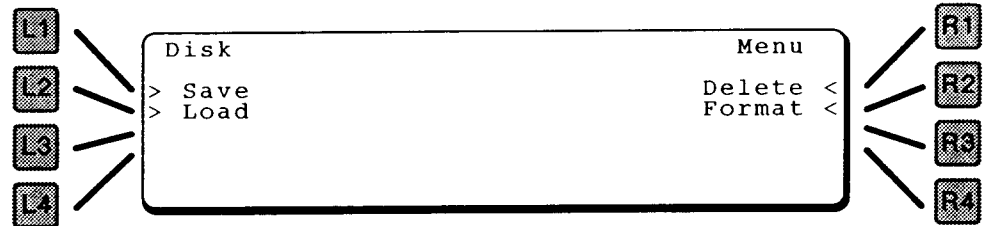

There are four options for saving, loading, and deleting files, as well as for formatting new diskettes.

LI SAVE

This section is for saving the various types of files in the K5000S to disk. Choose one of the options as described below.

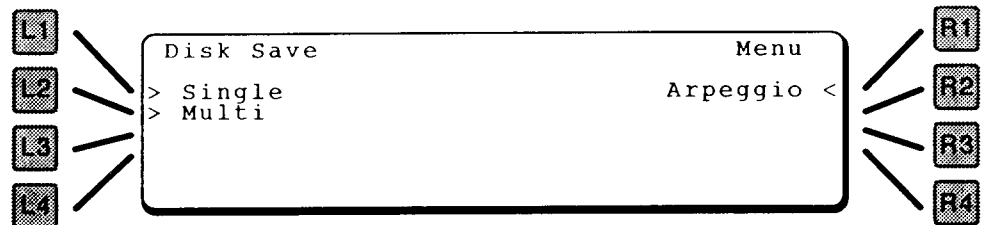

LI SAVE SINGLE

You can save individual Single patches or an entire bank to disk.

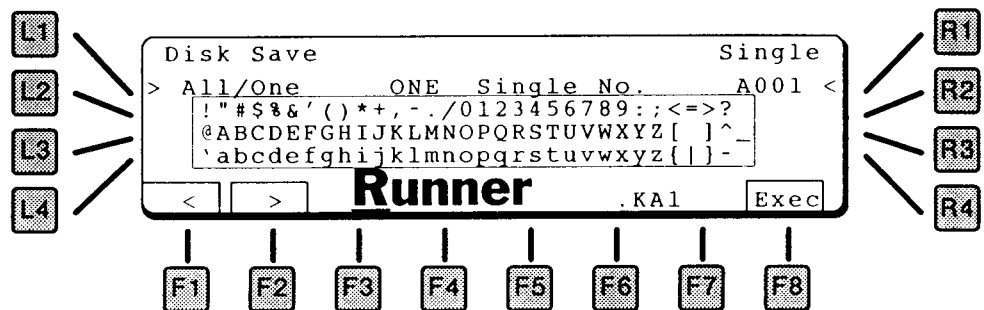

LI ALL/ONE

Choose ALL the patches in a bank, or just ONE.

NOTE:

The single bank selected before entering the Disk Section will be the only bank available.

R1 SINGLE NO.

If you want to save one patch to disk, select the patch number here.

F1/F2 CHARACTER

This names the file on the disk. Use the F1 and F2 keys to select a character in the name (moves the cursor), and the Value dial to select a letter.

F8 EXECUTE

Press Execute to save the file. It will be saved with the file extension shown after the name. See page 119 for a list of K5000S file types.

L2 SAVE MULTI

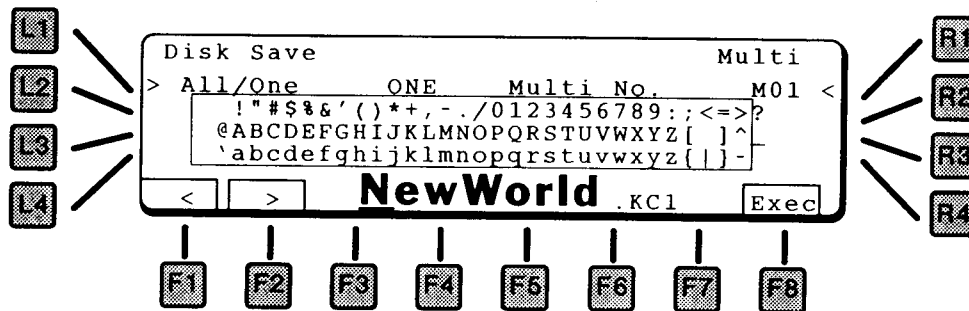

L1 ALL/ONE

Choose the entire MULTI bank, or just ONE Multi patch.

R1 MULTI NO.

If you want to save one patch to disk, select the patch number here.

F1/F2 CHARACTER

This names the file on the disk. Use the F1 and F2 keys to select a character in the name (moves the cursor), and the Value dial to select a letter.

F8 EXECUTE

Press Execute to save the file. It will be saved with the file extension shown after the name. See page 119 for a list of K5000S file types.

L3 SAVE ARPEGGIO PATTERN

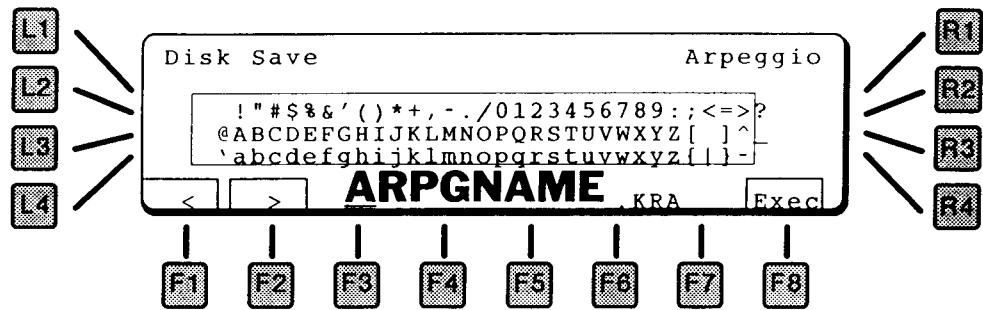

F1/F2 CHARACTER

This names the file on the disk. Use the F1 and F2 keys to select a character in the name (moves the cursor), and the Value dial to select a letter.

F8 EXECUTE

Press Execute to save the file. It will be saved with the file extension shown after the name. See page 119 for a list of K5000S file types.

L2 LOAD

This section is for loading the various types of files into the K5000S from disk. Choose one of the options as described below.

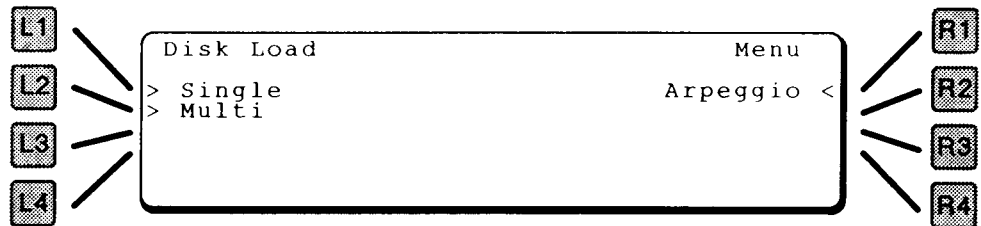

This shows the Load Single procedure. The others are similar.

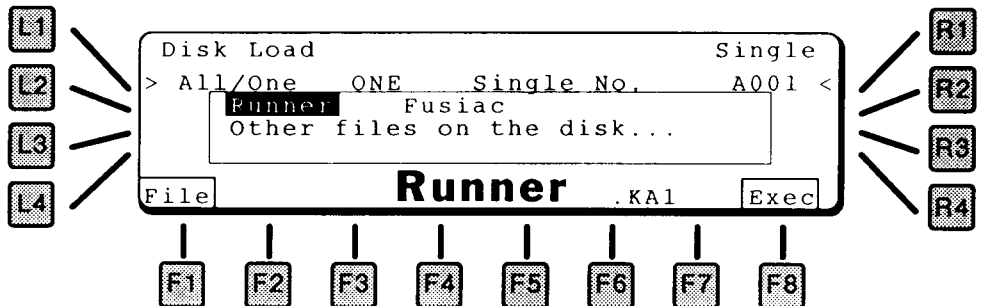

L1 ALL/ONE

Choose a patch bank file (.KAA) or a file with only ONE patch (.KA1).

R1 SINGLE NO.

This is the destination location for the file.

F1 FILE
This scrolls through the files on the disk that match the selected file type. Use the Value dial to select the desired file.

F8 EXECUTE
Press Execute to load the file.

MAC / WIN 95 USERS NOTE:
All file names must be in standard DOS 8+3 letter format or it will not be recognized.

RI DELETE

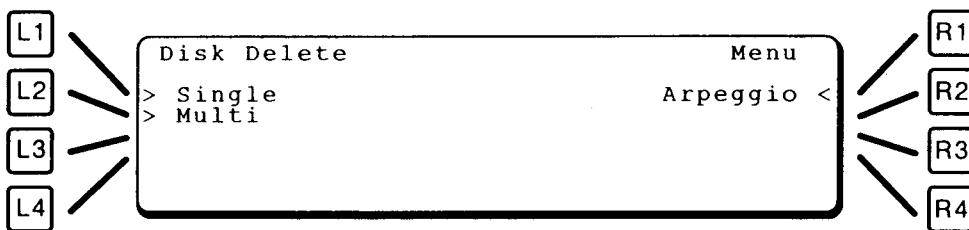

This shows the Delete Single procedure. The others are similar.

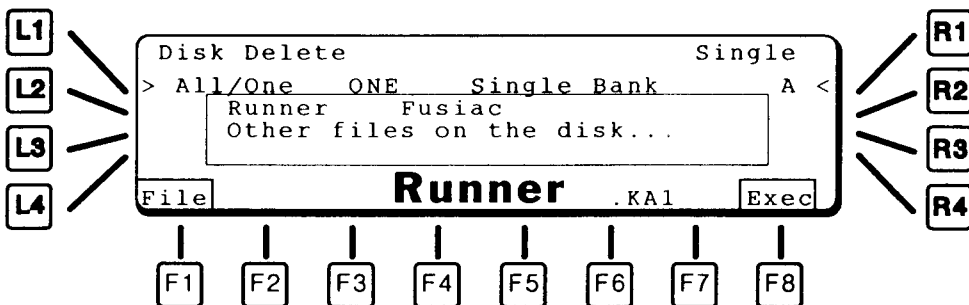

L1 ALL/ONE
Choose a patch bank file (.KAA) or a file with only ONE patch (.KA1).

R1 SINGLE BANK
Select the type of Single bank to delete: A or D.

F1 FILE
This scrolls through the files on the disk that match the selected file type. Use the Value dial to select the desired file.

F8 EXECUTE
Press Execute to delete the file from the disk.

R2 FORMAT

```
Disk Format
> Format          1.4MB
   Formatting Will Destroy All Data
   On The Disk.
                               Exec
```

This formats a disk to be used by the K5000S. The K5000S uses the same format as IBM compatible PCs. If a diskette is already formatted in standard PC format, then it is not necessary to reformat the disk.

L1 FORMAT TYPE

Choose the type of disk you wish to format: 1.4MB for High Density diskettes (2HD), 720KB for older Double Density diskettes (2DD).

F8 EXECUTE

This starts the format process. Press F8 to continue, F1 to cancel.

FILE FORMAT LIST

The following file formats can be read and written by the K5000S:

FUNCTION	DATA	FILE TYPE	FILE NAME	EXAMPLE	READ/WRITE
Save/Load	Single ADD	One	*.KAI	A32	o
		All	*.KAA	A1-A64	o
	Multi (or Combi)	One	*.KCI	M1	o
All		*.KCA	M1-M64	o	
	Arpeggio	All	*.KRA		o
Operating System	Program		K5000SR.SYS		Read Only

QUICK MIDI

The following MIDI messages can be sent from this page. Messages are sent on the MIDI System Channel, set in the System MIDI page. The MIDI System Channel is shown at the top of the screen.

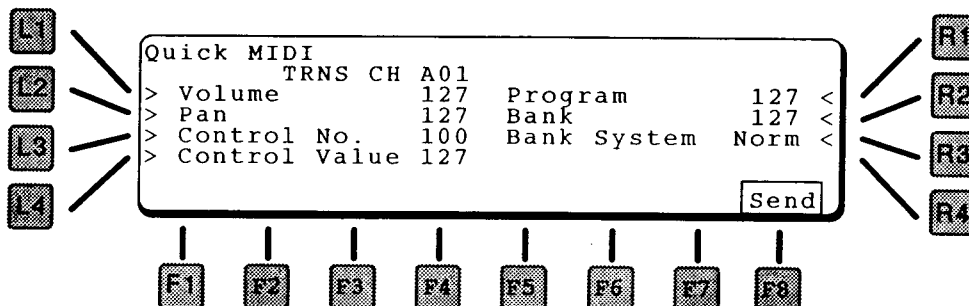

L1 VOLUME

Sends a Volume message using Continuous Controller #7.

L2 PAN

Sends a Pan message using Continuous Controller #10.

L3 CONTROL NUMBER

There are 128 Continuous Controller channels in MIDI. Some, like the Volume, Pan, Sustain Pedal, and Bank Select messages are commonly used by all instruments. Other controllers are more specific and are used for everything from synthesizer parameters to automated mixing to controlling stage lights or even a VCR.

This parameter selects one of the Continuous Controller channels for control (0 to 127).

L4 CONTROL VALUE

This sets the *value* of the message sent to the Continuous Controller channel selected above.

R1 PROGRAM

Sends a Program Change message, which tells a remote instrument to change to a different sound patch. There are 128 Programs available, numbered from 0 through 127.

R2 BANK

Most recently made instruments contain more than 128 patch programs in memory. MIDI gets around this limitation by dividing the available sound programs into several *banks of programs*. Use the Bank and Bank System messages to specify which bank to switch to. Within an individual bank, the Program Change message can be used to select individual programs.

R3 BANK SYSTEM

The Bank System parameter selects the type of bank select message to send.

NORMAL

Normal – the bank message is sent by itself

1 (MSB)

MSB – the bank message is sent with an MSB indication.

2 (LSB)

LSB – the bank message is sent with an LSB indication.

F8 SEND

This transmits all the messages.

APPENDIX

SINGLE BANK SOUNDS

BANK A (BANK NO. 100)

BANK D (BANK NO. 102)

No	Name	Category	No	Name	Category
A001	Runner	SFX	D001	DaLead	Lead
A002	Gorgizmo	SFX	D002	Dinosaur	Lead
A003	DstPulse	Lead	D003	OtaStack	Lead
A004	TelMetal	SEQ	D004	NoisyLD	Lead
A005	Driver	Techno	D005	Sunset	Lead
A006	Reznator	Bass	D006	TNT5000	Polysynth
A007	GOOM	Lead	D007	Fantapol	Polysynth
A008	Heaven	TXT Pad	D008	K.Lite	Polysynth
A009	Creaturz	TXT Pad	D009	Jumper	Polysynth
A010	K-Bells	Percus	D010	VelSquar	Polysynth
A011	Hardcore	Techno	D011	Entrance	Polysynth
A012	Mentara	Lead	D012	HerrFumy	Polysynth
A013	Shakkiri	Lead	D013	UndaWear	Polysynth
A014	Tweekey	Lead	D014	Morphos	Polysynth
A015	Tangeri	Lead	D015	Gulliver	TXT Pad
A016	Rasty	Lead	D016	Monks	TXT Pad
A017	Pyper	Lead	D017	K-Philes	TXT Pad
A018	Clavaxx	Polysyn	D018	Hot Spot	TXT Pad
A019	BrasMorf	Polysyn	D019	FloorSaw	BG Pad
A020	Insyncer	Polysyn	D020	Scotty	BG Pad
A021	Fusiac	Polysyn	D021	Peaceful	BG Pad
A022	HyprWyr	Polysyn	D022	Breathy	BG Pad
A023	History	Polysyn	D023	VoiceStr	BG Pad
A024	Launcher	Polysyn	D024	Chamber	BG Pad
A025	Wintage	Polysyn	D025	Interpol	BG Pad
A026	LeadVox	Polysyn	D026	O-Tone	BG Pad
A027	VooCoo	Polysyn	D027	Raver	Techno
A028	Sweepipe	Polysyn	D028	FFBass	Bass
A029	Formanta	Polysyn	D029	Crystalz	Percus
A030	HardFaze	TXT Pad	D030	WireTrap	Percus
A031	TalkGlas	TXT Pad	D031	CybaStr	Percus
A032	Eaglelan	TXT Pad	D032	Vector	Percus
A033	Bee3Pad	TXT Pad	D033	Nylong	Percus
A034	Zisch	TXT Pad	D034	BellEcho	Percus
A035	WheelPad	BG Pad	D035	NewGhost	SFX
A036	HotSweet	BG Pad	D036	Aquarius	SFX
A037	Engage	BG Pad	D037	Meltonin	SFX
A038	Starship	Techno	D038	Moover	SFX
A039	RaveRizm	Techno	D039	Castalia	SFX
A040	TB5005	Techno	D040	Quack	SEQ
A041	Frogga	Techno			
A042	TeknoBas	Techno			
A043	RoboBass	Bass			
A044	Basstron	Bass			
A045	DooBass	Bass			
A046	YazzaY	Percus			
A047	Richness	Percus			
A048	HolyVibe	Percus			
A049	Plukk	Percus			
A050	Seaworld	SFX			
A051	4thPlane	SFX			
A052	Moduar	SFX			
A053	Chimera	SFX			
A054	Opposite	SFX			
A055	Nebular	SFX			
A056	Melmaker	SFX			
A057	Rippin	SFX			
A058	Ultimate	SEQ			
A059	Talkie	SEQ			
A060	Mices	SEQ			

MULTI BANK SOUNDS

(BANK NO. 101)

M01	NewWorld	M33	Uglyduck
M02	Halo	M34	AttkBras
M03	Yin&Jan	M35	Midnight
M04	EyesLee	M36	Bas¥Lead
M05	Horror	M37	Dreamin
M06	CHRMLLead	M38	Heather
M07	BeGentle	M39	Moonset
M08	BraStack	M40	BigWorld
M09	Tibetan	M41	H.Vibe*2
M10	Sphere	M42	DreamHrn
M11	ESP.Bass	M43	KamAlien
M12	Meltopol	M44	FarFa
M13	CybaTekn	M45	Mallthit
M14	FatPlukk	M46	Add*Zon2
M15	Junctio2	M47	Sunlite
M16	SuperLow	M48	Bell-pol
M17	Ota_mill	M49	SoftLead
M18	TimeWrp2	M50	Wavers
M19	LochNess	M51	Histry*3
M20	MonoPoly	M52	CashFlo2
M21	AddSDrum	M53	RotoPad
M22	TecSplit	M54	ThikClav
M23	ASIA2	M55	HelpHand
M24	Vantage	M56	Sta+Crec
M25	Purple-O	M57	Submerg2
M26	HalfTone	M58	HyprComp
M27	Calmy	M59	Fleeting
M28	UnizoLD	M60	LeadIt
M29	NoHitter	M61	Passing
M30	RockLead	M62	RawAdd1
M31	S-Pluck	M63	AftrThot
M32	London	M64	Open2001

PCM WAVE LIST

Wave #	Group	Memo	Wave #	Group	Memo
342	Inst Noise Attack	Piano Noise Attack	399	Cyclic Loop	Syn PWM Cyc
343		EP Noise Attack	400		Harpshichord Cyc
344		Percus Noise Attack	401		Digi EP Cyc
345		Dist Gtr Noise Attack	402		Soft EP Cyc
346		Orch Noise Attack	403		EP Bell Cyc
347		Flanged Noise Attack	404		Bandneon Cyc
348		Saw Noise Attack	405		Chees Organ Cyc
349		Zipper Noise Attack	406		Organ Cyc
350	Inst Noise Looped	Organ Noise Looped	407		Oboe Cyc
351		Violin Noise Looped	408		Crystal Cyc
352		Crystal Noise Looped	409		Syn Bass1 Cyc
353		Sax Breath Looped	410		Syn Bass2 Cyc
354		Panflute Noise Looped	411		Syn Saw1 Cyc
355		Pipe Noise Looped	412		Syn Saw2 Cyc
356		Saw Noise Looped	413		Syn Saw3 Cyc
357		Gorgo Noise Looped	414		Syn Square1 Cyc
358		Enhancer Noise Looped	415		Syn Square2 Cyc
359		Tabla Spectrum Noise Looped	416		Syn Pulse1 Cyc
360		Cave Spectrum Noise Looped	417		Syn Pulse2 Cyc
361		White Noise Looped	418		Pulse20 Cyc
362	Inst Attack	Clavi Attack	419		Pulse40 Cyc
363		Digi EP Attack	420		Nasty Cyc
364		Glocken Attack	421		Mini Max Cyc
365		Vibe Attack	422		Bottom Cyc
366		Marimba Attack	423		Over 64th harm onics only Cyc
367		Org Key Click	424		Over 64th harmonics only Cyc
368		Slap Bass Attack			
369		Folk Gtr Attack	425	Percus Attack	BD Attack
370		Gut Gtr Attack	426		Ana Kick
371		Dist Gtr Attack	427		SD Attack
372		Clean Gtr Attack	428		Tiny SD Attack
373		Muted Gtr Attack	429		Ana SD Attack
374		Cello & Violin Attack	430		Ana HKO Attack
375		Pizz Violin Attack	431		Simonzu Tom Attack
376		Pizz Double Bass Attack	432		Ride Cup Attack
377		Doo Attack	433		Cowbell Attack
378		Trombone Attack	434		Conga Attack
379		Brass Attack	435		CongaMuted Attack
380		F.Horn1 Attack	436		Agogo Attack
381		F.Horn2 Attack	437		Castanet Attack
382		Flute Attack	438		Claves Attack
383		T.Sax Attack	439		Tambourine Attack
384		Shamisen Attack	440		JingleBell Attack
385	Analog Attack	Voltage Attack	441		BellTree Attack
386		BBdigi Attack	442		WindowChime Attack
387		BBDX Attack	443		Atarigane Attack
388		BBBlip Attack	444		Rama Attack
389		Techno Hit Attack	445		Udo Attack
390		Techno Attack	446		TablaNa Attack
391		K-Piano Attack	447		Voice Du Attack
392	Analog Loop	Noisy Voise Looped	448		HighQ Attack
393		Noisy Human Looped	449		Super Q Attack
394		Ravoid Looped	450		Glass Attack
395		Hyper Looped	451		Metal Attack
396		Beef Looped	452		Noise Attack
397		Texture Looped	453		Pop Attack
398		MMBass Looped			
			454	S.E Loop	Crash Looped
			455		Burner Looped
			456		Jet Engine Looped
			457	Omnibus Loop	Omnibus Loop 1
			458		Omnibus Loop 2
			459		Omnibus Loop 3
			460		Omnibus Loop 4
			461		Omnibus Loop 5
			462		Omnibus Loop 6
			463		Omnibus Loop 7
			464		Omnibus Loop 8

Kawai Musical Inst. Mfg. Co., Ltd.
OW621E-R 9611
Printed in Japan

