

Cherry Audio's Eight Voice is an emulation of the mighty Oberheim® Eight Voice synthesizer, originally unleashed in 1977. It began life in 1974 as a simple, keyboardless mono synth called the Synthesizer Expander Module, or "SEM." The SEM module was intended as a companion to the Oberheim DS-2, one of the earliest digital sequencers. Oberheim soon realized they could interface a digitally scanned keyboard, mount the whole mess in a big box, and create polyphonic synthesizers, beginning with the Two Voice, followed by the Four Voice, and finally the beastly Eight Voice.

Though it was one of the first synthesizers to utilize a digitally scanned keyboard that assigned notes to independent synth voices, unlike later analog polysynths, it lacked computer control and parameter storage. This meant that each of its eight synthesizer voice modules contained individual controls for *every parameter*. If you wanted to adjust the filter resonance, for example, you'd need to change the resonance control on *every one* of the eight synthesizer voices, otherwise each note played would sound different.

This allowed for varying timbres for different notes, a potentially musically useful and interesting effect, but not much fun if you wanted every note to sound the same.

The Eight Voice did include a crude programmer section with 16 patch storage slots, but instead of storing actual knob and switch values, it simply added offset voltages to the existing knob setting. In other words, a user would set the knobs to zero, and the programmer could “turn up” the knobs by adding a voltage value. Only a handful of parameters were “storable,” per se, and switch positions couldn't be stored. This made changing sounds during a live performance a dicey affair at best.

So why would anybody deal with this madness? If you needed a synthesizer that could play chords in the 70s, you had very limited options. To their credit, the early Oberheim synths sounded fantastic, and few other poly synths of the era could play individually articulated polyphonic notes (i.e. each note having its own separate filter/amplitude envelope). Once the computer-controlled Sequential Circuits Prophet-5 came along in 1978 with single knobs controlling common voice parameters and full digital patch storage, the heyday of Oberheim's Two, Four, and Eight Voice instrument instantly ended. Oberheim released the OB-X soon thereafter, which used microprocessor control to achieve similar functionality to the Prophet-5.

The Cherry Audio Eight Voice retains Eight Voice's stupendous sound quality, but its unique *Voice Link* section lets users link the controls of voice modules, eliminating the need to individually set each module's controls when “homogenous” poly sounds are desired. Additionally, the tool bar “focus” buttons allow any section of Eight Voice to instantly “zoom in” to a much larger size, making editing much easier (especially on smaller displays).

Each module also contains easy to use *Key Range* zone selectors for endless layering and zoning possibilities. An expanded version of the Oberheim eight-step *Mini Sequencer* is also included, featuring switchable step gating, adjustable gate length, pitch quantization, and more. We've also thrown in a powerful mod delay, and a lush reverb section. All in all, we've done everything possible to transform the original instrument's daunting user interface into a fast, fun, and most of all, creative musical experience. You're gonna love it!

### **Technical Assistance**

Cherry Audio's unique online store and automatic updating should make operation a smooth experience, but if you run into any issues or have questions, you can discuss issues online at the Cherry Audio forums at:

<https://forums.cherryaudio.com/viewforum.php?f=45>

... or you can communicate directly with one of our surly and grumpy, scratch that... outgoing and friendly tech support staff at:

<https://cherryaudio.kayako.com/>

Oberheim® and SEM are trademarks of Tom Oberheim. There is no association, affiliation or endorsement of Cherry Audio or its products by Tom Oberheim.

# Eight Voice Architecture

The Eight Voice can be thought of as eight independent dual-oscillator monophonic synthesizer voice modules. In actuality, this is how one could think of *most* polyphonic analog synthesizers, but unlike other poly synths, the Eight Voice contains *separate* controls for all parameters for *each* voice. Looking at the panel, it's easy to see the eight identical voice modules, with Voice 1-4 in the top row, and Voice 5-8 in the row beneath. For example, Eight Voice has a filter cutoff knob for the filter of each voice module. Conversely, a typical classic poly synth (think Sequential Prophet-5 or a Roland Juno-series) would have a single filter cutoff control. In reality, this control is multiplexed to control the filter cutoff of multiple filters simultaneously (five filters in the case of the Prophet, or six of them in the Juno). The original Oberheim Two, Four, and Eight Voice instruments predated microprocessor that allowed this control multiplexing.

Lucky for you, it isn't 1978, and the Cherry Audio Eight Voice features intelligent *Link Groups* that allow highly flexible linking of controls. This makes programming homogenous polyphonic patches a breeze (by "homogenous," we mean all notes sound the same). What's even niftier is that voice linking can be easily disabled, allowing individual editing of each voice - this works particularly well for minute tuning, panning, or filter changes that breathe life into poly patches in a way "normal" synths can't.

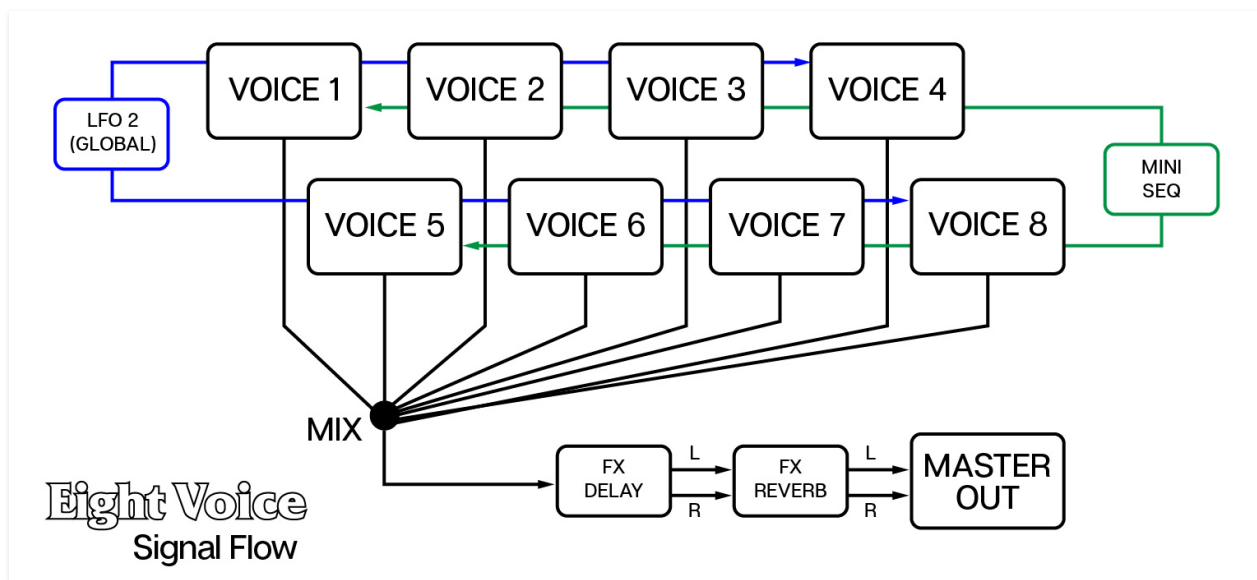

The voice modules themselves bear a great resemblance to the original Oberheim SEM modules of the 70s. Each of these features two oscillators, a state-variable filter with continuously variable lowpass-to-highpass response

or bandpass mode, two ADS envelope generators, and a low-frequency oscillator.

At the bottom of each module are its voice assign controls; these allow each modules to react differently (or similarly) to notes played on the keyboard or via the eight-step Mini Sequencer. These are where the Eight Voice's true power lies - it can behave as monophonic synth with up to 16 oscillators, an eight-voice polyphonic synth or anything combination thereof. Any number of the voices can be played by the Mini Sequencer, and notes played on the keyboard may optionally transpose sequencer CV playback. Additionally, each voice module can play within a user-defined key range. This makes splitting and layering very easy. (Right around now perhaps you're thinking, "this thing rules!," and you would be correct.)

We'll explain the synthesis and module voice assign specifics of the eight modules in later sections.

Each voice module has a master volume and pan control (excellent for super-wide detuned patches). These get routed to Eight Voice's syncable mod delay and reverb sections, and then onto the master volume control. We've also included a transparent limiter, because sometimes Eight Voice's huge sounds can get a little out of hand, level-wise.

The bottom strip also contains master controls that affect all voices, including tuning, transpose, and pitch bender depth, a master filter offset control (more on this in the VCF section), poly and unison mode and portamento (glide) controls, a "bonus" global, syncable LFO, and the aforementioned Mini Sequencer.

# Top Toolbar and Preset Browser

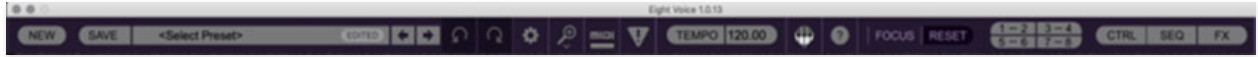

The purple strip at the top of the Eight Voice is contains all of the preset loading and saving navigation, "under-the-hood" settings, zoom and focus controls, and more.

Even if you breeze through this section, **makes sure to check out the *Focus* controls - they make Eight Voice's Really Big User Interface WAY easier to use.**

**New**- Opens a new blank patch preset. If an unsaved patch is currently open or you've modified an existing saved patch, a dialog asks if you'd like to save the patch in its current state. This greatly reduces the possibility of losing an edited unsaved patch.

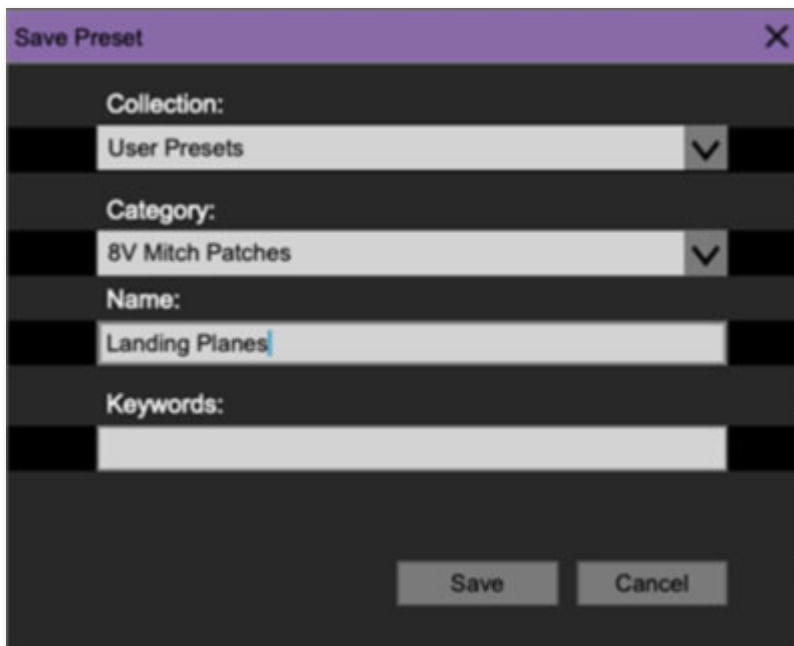

**Save**- Use this to save patches. There are a couple of levels of hierarchy:

- **Collection**- This is the top level of organization, and contains entire "sets" of presets. The *Eight Voice Presets* are the main included collection. We also include a *User Presets Collection* for storing your own presets, but you're free to create your own collections. To create a new collections, click in the *Collection* text field (where it says *User Presets* above) and

type a name. User-created sounds can be freely saved to any collection; we like to keep 'em separated for organizational purposes.

- **Categories**- Within each *Collection* are a number of sound categories. As with collections, you're free to create as many categories as you like. To create a category, click in the *Category* text field of the *Save* dialog window and type a new category name.
- **Patch**- A patch is an individual sound. To save a patch, simply type the name in the *Name* field and click *Save*.
- **Keywords**- You can add descriptive words such as "huge," "noisy," "poly," etc., to patches to make them appear when terms are typed in the *Search* field. Use commas to separate multiple keywords entries.

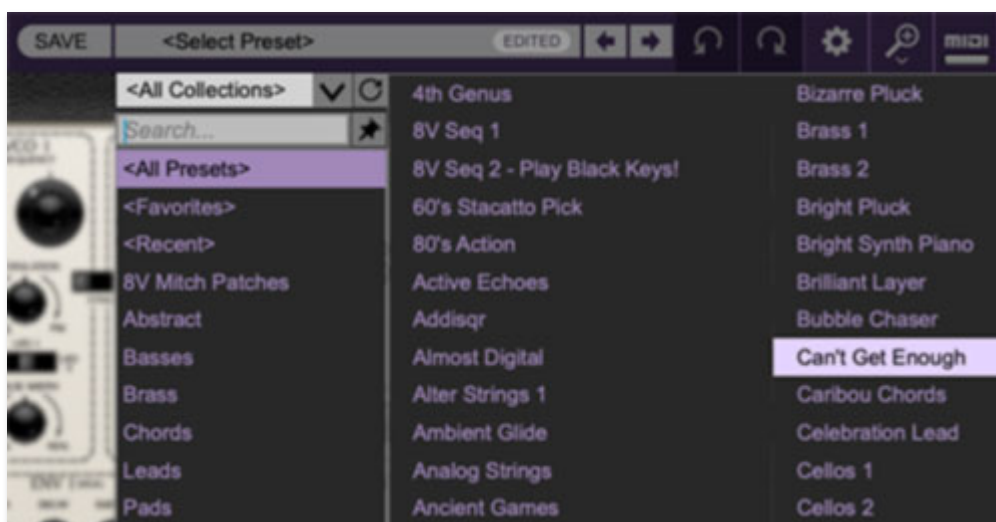

**Browsing Patches**- Patches can be browsed by clicking the *<Select Preset>* field. To select a preset collection, click in the area that says *<All Collections>* or on the downward-facing arrow next to it.

Clicking on the left-side categories narrows down which patches are displayed.

- **<All Presets>** will show presets from all collections and categories.
- **<Recent>** displays recently used presets.
- **Refresh**- This is the circular arrow button to the right of the downward arrow; clicking this checks the Cherry Audio server for new or updated presets.

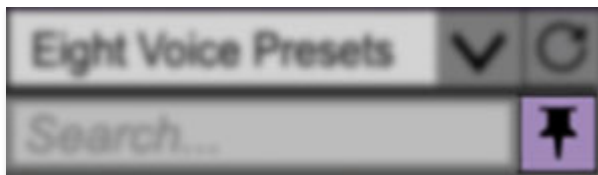

**Pin**- Clicking the push-pin icon locks the patch selection list open, allowing fast and easy browsing and auditioning of patches. Click the icon again to disable pin mode. when in pin mode, the up and down arrow keys can be used to select patches.

**Preset**- *Step Back/Forward Arrows*- These step to the previous or next preset. macOS [⌘+left/right arrow key] or Windows [CTRL+left/right arrow key] will navigate through presets back and forth in the currently selected collection/category.

**Undo/Redo**- These circular arrows will undo or redo the last action. It remembers many steps, so if you really loused something up, keep on clickin'...

**Settings**- This is where user preferences for user interface, audio interfaces, user account, and more are configured. See the **Settings** section for full information.



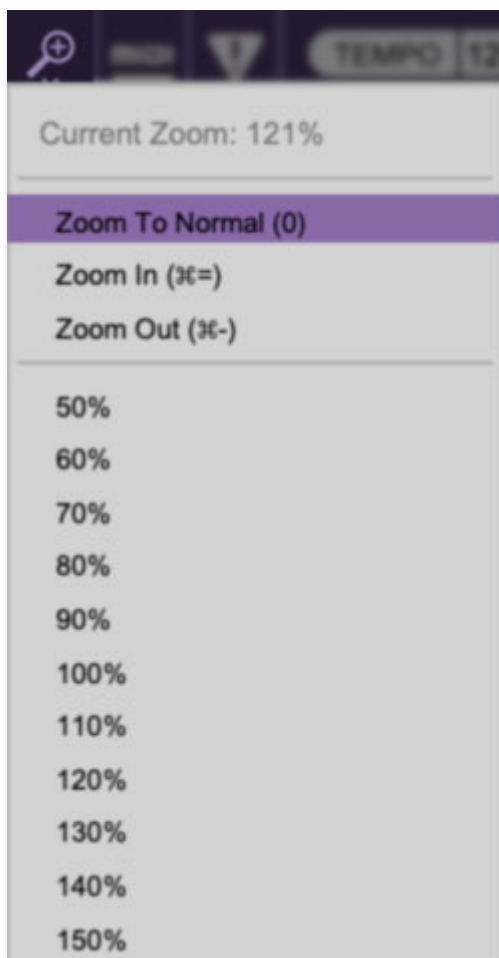

### **Importing Presets with drag-and-drop**

Presets can be imported singly or en masse (as a single compressed ZIP file) simply by dragging and dropping from the desktop anywhere on the user interface.

If a single \*.preset file is dragged and dropped, the sound is immediately loaded and the standard Save Preset dialog appears; this lets you save the sound to the instrument's preset browser. Note that you don't have to save the sound to preset browser; if you just want to hear and play the sound, click the Cancel button in the Save Preset dialog - the sound will still be loaded.

Compressed zip files containing multiple sounds can also be drag and dropped onto the UI. This works the same as with single sounds, but instead of the Save Preset dialog, you'll see the Import Preset Collection dialog. The presets will be added as a new collection and available in the categories for which they were tagged.

**Zoom Magnifying Glass** - Click to resize the Eight-Voice interface. Selecting *100%* returns the user interface to native size.

**MIDI Tab**- Opens the MIDI controllers tab for configuring internal and hardware MIDI controls. See the [MIDI Controllers Setup and MIDI Tab](#) section for full information.

**! (MIDI Panic)**- Click to send an all-notes-off message in case of, "make this dang thing shut up?!?" stuck-note incidents.

**Tempo (Standalone Version Only)**- Displays Eight Voice's current internal tempo setting. Eight Voice's internal tempo affects the *LFO 1*, global *LFO 2*, and the *Delay* sections when their corresponding *Sync* switches are in the up position. The tempo setting can be changed by moving the mouse up and down anywhere in the tempo section, or by double-clicking the number and entering the desired BPM value.

***The tempo display only appears in the standalone version of Eight Voice. VST, AU, and AAX plug-in versions receive tempo data from their host DAW app.***



**QWERTY Musical Typing Keyboard**- Opens an onscreen keyboard allowing a standard QWERTY computer keyboard to be used for playing music notes. For more information, see [QWERTY Musical Typing Keyboard \(MTK\)](#) section.

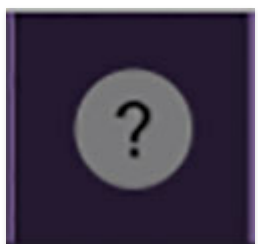

**Help** - Clicking this launches your web browser and opens the help document you're currently reading. Which means you're already here...

**Eight Voice (left side) and yellow Cherry (right side) logos**- Clicking either of these displays "about" information, and shows the version number and current registered user ID.

# Preset List Right-Click Functions

---

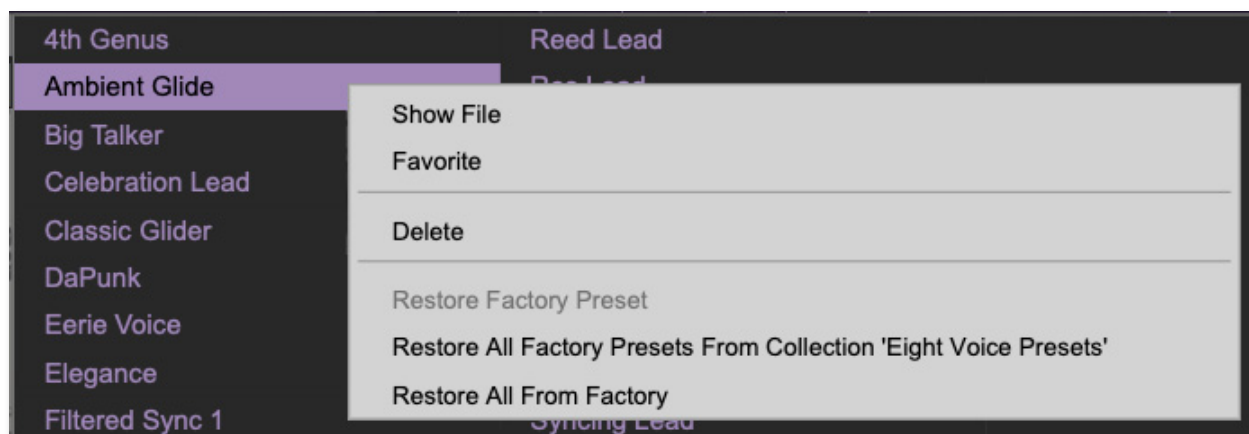

**Show File**- This displays the selected preset in the Mac or Windows folder containing it. This is useful for backing up or sending a preset file to another user.

**Show In Original Category**- Selects the preset within its category, i.e. the category will highlight in the left preset menu. The *Show In Original Category* command only displays if the preset was selected within the *<All Presets>*, *<Favorites>*, or *<Recent>* categories.

**Favorites**- Favorited presets will show in when the *<Favorites>* category is selected. A star will display next to the preset name. Right-click on the preset and reselect *Favorite* to un-favorite it.

**Delete**- Deletes the selected preset.

**Restore Factory Preset**- If one of the factory (i.e. not user) patches is edited and saved, selecting this command restores the patch to its unaltered "factory" setting. This menu will be grayed-out for user bank patches.

**Restore All Factory Presets From 'Eight-Voice Presets'** - If any patches from the "factory" Eight-Voice bank are edited and saved, selecting this command restores *all* of them to their unaltered "factory" setting.

**Restore All From Factory**- If any patches from the "factory" banks are edited and saved, selecting this command restores *all* of them to their unaltered "factory" setting. At the time of writing, the Eight Voice bank mentioned above is the only factory bank, so this function and the *Restore All Factory Presets From 'Eight-Voice Presets'* above have the same effect.

**Show File**- This displays the selected preset in the Mac or Windows folder containing it. This is useful for backing up or sending a preset file to another user.

# Focus

---

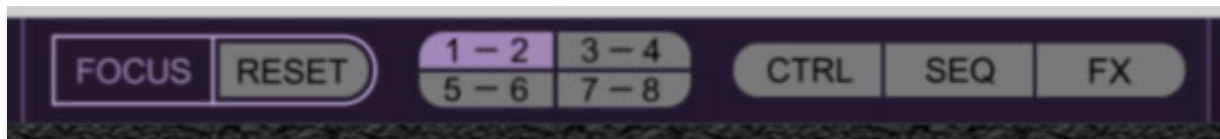

Fitting eight independent monophonic synthesizers onto a computer screen presented some challenges, especially for laptop or other small-display users. We wanted users to enjoy the experience of the classic Oberheim Eight Voice, but by its nature, that meant shoehorning a whole lotta synthesizer onto the screen. Cherry Audio Eight Voice elegantly solves this issue with its simple *Focus* button array. It's ridiculously easy to use and greatly improves the user experience.

The *1-2*, *3-4*, *5-6*, *7-8*, *CTRL*, *SEQ*, and *FX* buttons instantly enlarge the corresponding Eight Voice sections to fill the current window size (as selected with the *Zoom* magnifying glass icon in the top toolbar, or by adjusting window size with the "treaded" grab handle at the bottom-right of the window. The *Focus* buttons do not alter the overall window size.

**Focus/Reset**- Cancels current focus zooming to display the full instrument at any time. Though *Focus* is intended as a label for the entire section, you can click anywhere on *Focus/Reset*.

**1 - 2**- Zooms and enlarges Voice 1 and Voice 2.

**3 - 4**- Zooms and enlarges Voice 3 and Voice 4.

**5 - 6**- Zooms and enlarges Voice 5 and Voice 6.

**7 - 8**- Zooms and enlarges Voice 7 and Voice 8.

**Ctrl**- Zooms and enlarges the left section of the bottom controls, including Tune, Filter Offset, Link Groups, Poly Assign Mode, Portamento, and LFO 2.

**Seq**- Zooms and enlarges the Mini Sequencer.

**FX**- Zooms and enlarges the Delay and Reverb effects, as well as the Master output section.

**Alternatively, *Focus* can be directly accessed** with [CTRL]+click (Windows) or [CMD]+click (Mac) by clicking anywhere in the user interface. [CTRL]+click / [CMD]+click again will resume normal view.

Once any section is "focused," vertical and horizontal scroll bars appear and the UI can be freely scrolled.

# VCO 1 and 2

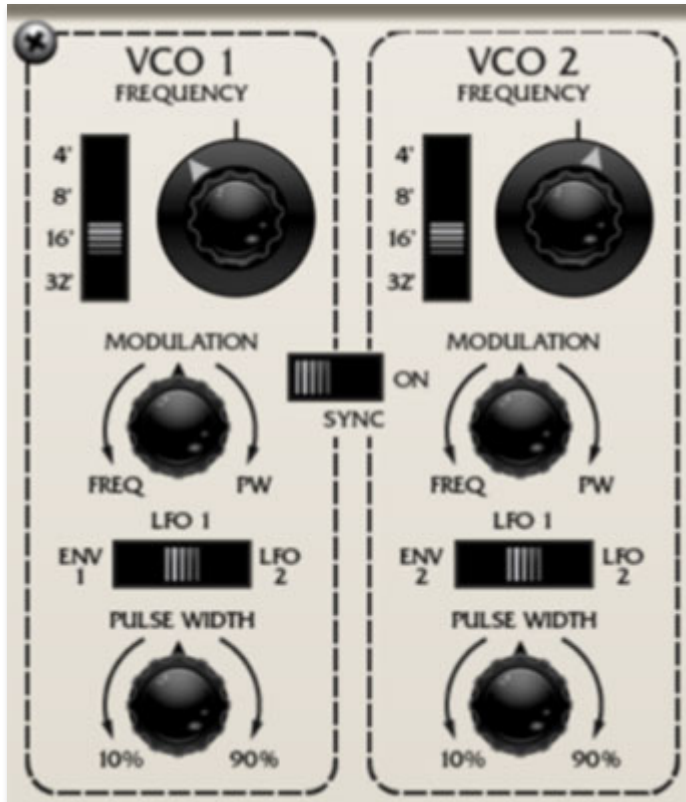

The voice modules each contain two almost identical voltage-controlled oscillators. The only difference are their modulation routing options.

**Range-** Sets the pitch range for each oscillator in octaves. These are at standard organ footage settings of 32', 16', 8', and 4'.

**Frequency knob-** This can be used to fatten up two oscillator patches by detuning a small amount, or for "building-in" a set interval. Its range is a smidge over a fifth, up or down.

**Modulation amount knob and source switch-** The mod amount knob is bidirectional; rotating it left from center position adds pitch modulation, rotating it right modulates pulse width of the pulse wave. Center position is off, i.e. no modulation.

The three-position slide switch selects the oscillator mod source from three sources:

- **Env 1 (VCO 1) / Env 2 (VCO 2)-** Modulation source is envelope 1 or envelope 2. Selecting the envelopes as mod source doesn't "disconnect" them from the VCA or VCF.
- **LFO 1-** The module's onboard LFO.

- **LFO 2**- LFO 2 in the master section. LFO 2 is global to the entire instrument.

**Pulse Width**- Sets the width or "duty-cycle" of the pulse wave. It has no effect on the saw wave. This defaults to 50%, i.e., a perfect square wave. Moving the knob left or right narrows its width as well as the thickness of sound until it almost disappears at its extremes.

**Sync**- This causes VCO 1 to force reset the start of VCO 2's waveform to the beginning of its cycle, resulting in a wide range of harmonic tones from VCO 2. The range of tones can be varied by adjusting VCO 2's *Frequency* controls.

**Choosing oscillator waveforms**- *One unusual aspect of the Oberheim SEM design is that the oscillators themselves contain no waveform controls. Instead, the level of saw and pulse waves is adjusted via mixer knobs at the bottom of the VCF section.*

# Filter Section

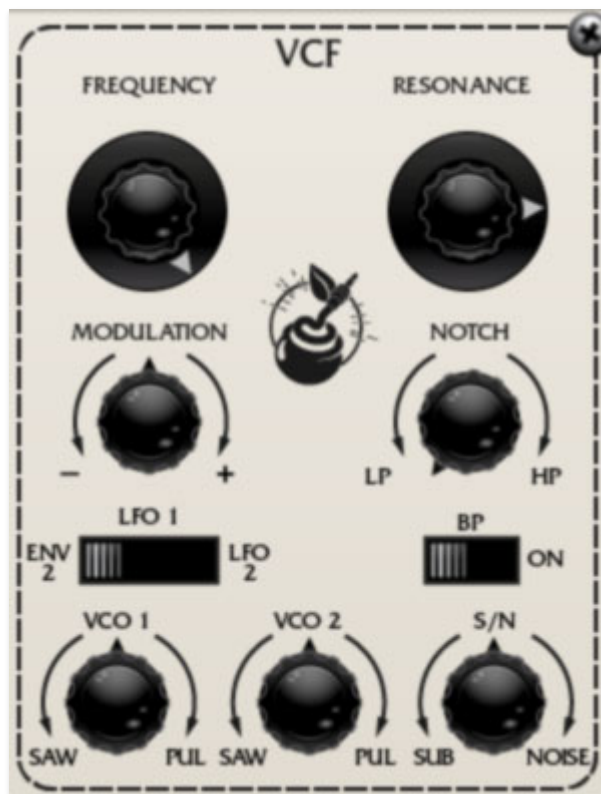

Eight Voice's filter section represents a departure from the 24 dB "ladder" style filter often seen in vintage synths. Like the Oberheim SEM module it's based on, Eight Voice uses a 12 dB state-variable filter (no, this doesn't mean it can sound like Rhode Island or Montana). This refers to its curves - it can function as a lowpass, bandpass, or highpass filter and features a knob allowing a continuous sweep from lowpass to highpass response (with "notch" filtering in the middle position). This gives it a great deal of flexibility, and the 12 dB curve gives it a brighter overall tonality than a typical ladder filter.

If you're not familiar with how filters work, a lowpass filter allows frequencies *below* the cutoff frequency setting to pass through, but blocks frequencies *above* the cutoff frequency. Highpass is the opposite of lowpass mode: high-frequency content remains, but low frequencies are removed as the cutoff frequency increases. Sliding the *Bandpass* switch enables Bandpass mode combining both lowpass and highpass modes, leaving sound only "in the middle." The cutoff frequency lies roughly halfway between the falloff on each side.

**Frequency-** Sets the frequency where frequency attenuation begins with its effect dependent upon the currently chosen lowpass/bandpass/notch/highpass/etc. filter mode.

**Resonance-** Emphasizes sound energy at and around the cutoff frequency by adding feedback from the filter's output back to its input. This is useful for creating commonly heard synth "wah" tones, especially when the cutoff frequency is modulated with an envelope generator or one of the LFO's.

**Modulation amount knob and source switch-** Applies modulation to the filter cutoff frequency. The mod amount knob is bidirectional; rotating it right from center position adds positive modulation, rotating it left adds negative modulation. Center position is off, i.e. no modulation.

The three-position slide switch selects the filter mod source from three sources:

- **Env 2-** Though it can modulate VCO 2, Env 2 can be thought of as a dedicated filter envelope.
- **LFO 1-** The module's onboard LFO.
- **LFO 2-** LFO 2 in the master section. LFO 2 is a single global LFO for the entire instrument.

**LP>HP/Notch control-** Continuously varies the filter response from lowpass to highpass as the knob is rotated from left to right. The middle position creates a notch response.

**BP (bandpass) switch-** Alters the filter response to bandpass when engaged (i.e. combination of lowpass and highpass leaving frequencies "in the middle." The LP>HP knob disappears when the BP switch is enabled.

**VCO 1 / VCO 2 Saw/Pulse level-** The *VCO 1* and *VCO 2* knobs adjust the volumes of the saw and pulse waves for VCO 1 and 2, respectively. These are bidirectional knobs as well - rotating them left from center position increase the saw wave level, rotating it right increase the volume of the pulse wave. Center position is off (**if you're getting no sound, check these first**).

**Sub/Noise level-** When rotated to the left, sets sub-octave level, when rotated right, sets the level of the noise generator. The sub-octave is a one-octave down square wave derived from VCO 1. Its waveshape and level are not affected by the *VCO 1 Saw/Pul* knob.



# Envelope 1 and 2



The original SEM modules included two attack/decay/sustain (ADS) envelope generators. These function much the same as more common attack/decay/sustain/release (ADSR) envelopes, the only difference is that the decay and release stages are combined into one control.

## How They Work

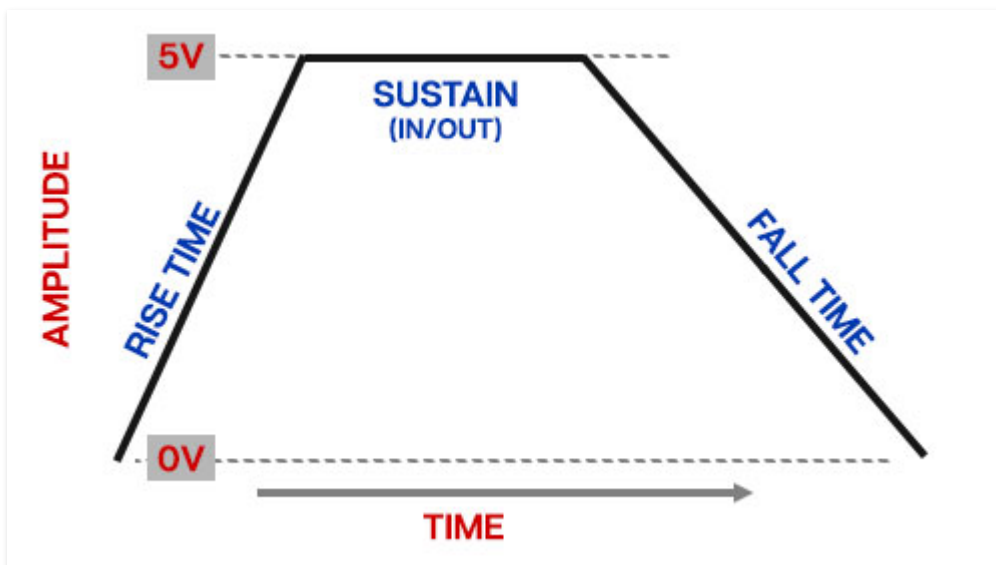

When a voice sees a gate voltage from a note, the envelope outputs a dynamically changing voltage, according to the settings of its stages. The *Attack* stage defines how long it takes for the output voltage to rise from 0 to 5 volts. Once the *Attack* stage reaches 5V, it moves to the *Decay* phase. If the key is released, the *Decay* knob defines how long it takes for the voltage to fall back to zero. If the key is held, the *Decay* time defines how long it takes to fall to the *Sustain* level setting. The note then holds at the *Sustain* level until it is released, and fades to zero at the time set by *Decay* knob -

the *Decay* knob effectively does "double-duty," acting as a decay and a release control.

## Envelope Controls

---

**Attack**- Defines the length of time for voltage to rise from 0V to 5V when a key is played.

**Decay**- If the key is released, the *Decay* knob defines how long it takes for the voltage to fall back to zero. If the key is held, the *Decay* time defines how long it takes to fall to the *Sustain* level setting.

**Sustain**- Sets the voltage (i.e. the level) the envelope holds at following the *Attack* and *Decay* phases.

**Vel (Velocity)**- Defines how much the envelope affects amplitude via keyboard velocity. When set to zero, keyboard velocity has no effect on amplitude; all the way up results in maximum dynamic range.

## Envelope 1 and 2 Routing

---

As indicated on the front panel, Env 1 affects the VCA, i.e., amplitude. It's hard-wired to the VCA, so no other routing is necessary. If VCO 1's three-way mod routing switch is set to the *Env 1* position, it will also modulate VCO 1's pitch.

Env 2 is mainly intended to modulate VCF cutoff frequency, but because it's not hard-wired, VCO 2's three-way mod routing switch needs to be in the *Env 2* position for cutoff mod to occur. In addition to filter cutoff frequency, Env 2 can also be used to modulate VCO 2's pitch when VCO 2's three-way mod routing switch is set to the *Env 2* position.

# LFO 1 and 2



Eight Voice includes two low-frequency oscillator (LFO) that generates sub-audio range signals intended for modulation purposes. Actually, Eight Voice has nine LFOs: one for each of the eight voice modules (LFO 1), and a global LFO for the entire instrument (LFO 2). We'll go over LFO 1 and LFO 2 separately as they differ a bit.

## LFO 1

---

Each voice module's LFO 1 section is fully independent. **LFO 1 is sine wave only.** Its controls are as follows:

**Sync-** When the *Sync* switch is in the up position, LFO speed will lock to host tempo when using Eight Voice within DAW software, or to the current tempo in the top menu bar when using the standalone version.

**Rate-** The *Rate* knob sets the speed of the LFO, from 0.08 to 15 Hz (with *Sync* switch off) or from 8 beats up to 1/64th note triplets (*Sync* switch on). The LED beside it flashes at the current rate.

## LFO 2 (Bottom Strip Controls section)

---

LFO 2 is global, that is, there's only one for the entire instrument. This is useful if you want to apply the same modulation to the entire instrument. Its controls are as follows:

**Sync-** When the *Sync* switch is in the up position, LFO speed will lock to host tempo when using Eight Voice within DAW software, or to the current tempo in the top menu bar when using the standalone version.

**Rate**- The *Rate* knob sets the speed of the LFO, from 0.08 to 30 Hz (with *Sync* switch off) or from 8 beats up to 1/64th note triplets (*Sync* switch on). The LED beside it flashes at the current rate.

**Mod Whl** - This is a really handy, but potentially confusing feature, so don't skim this section. If the slide switch is in the down/off position, the LFO is always "on." Its effects will be immediately audible if one of the module mod switches is set to use it. Clicking to the up/on position enables control of modulator depth with an external keyboard controller mod wheel. If the mod wheel is all the way down, mod depth is zero. This makes setting up a mod wheel to add vibrato or wah effects very easy. If it seems like LFO 2 isn't working, check if the *Mod Whl* switch is engaged (or just push up the mod wheel).

**Wave Select**- Chooses between sine, triangle, ramp, saw, square, and random-stepped waves.

***Not-so-obvious Important differences between LFO 1 and LFO 2:***

Besides its global operation and mod wave choices, LFO 2 has a faster maximum speed (30 Hz vs 15 Hz for LFO 1). Mod depth is also different - LFO 1 has a max mod depth of a whole step, whereas LFO 2 has a max mod depth of an octave. Here's why: we matched LFO 1's speed and depth to be the same as an original Oberheim SEM (we examined more than one!) for authenticity. Because LFO 2 is a "bonus" not present in the original Oberheim Two/Four/Eight Voice synths, we expanded its range for more flexibility. In this way, we hoped to offer the best of all worlds.

# Voice 1-8 and Key Range Sections



Looking in the bottom vicinity of a voice module, you'll see these are actually two sections, but their functions are closely related, so this chapter will be a "two-fer."

These controls regulate how each voice responds to incoming note data, most significantly, whether the voice plays monophonically (i.e. all incoming notes played on the keyboard sound one at a time, dependent on priority setting), or whether it plays polyphonically (i.e. notes are distributed to multiple voice modules in order to play chords). But there's more going on under the hood, and understanding how 8 Voice's various notes assign modes operate is the key to unlocking its massive flexibility, and understanding why Cherry Audio makes the coolest synths on the face of the earth. (Too much?)

## Voice 1-8 Assign Mode

---



**Voice Active LED-** The LED next to *Voice #* is a bi-color LED that glows red when it's receiving a MIDI note (i.e. note played on a keyboard controller or from a DAW), or green if the note is received from the onboard *Mini Sequencer*. This isn't just another cool flickering light - because of the many

ways voices can be configured, it's often very useful to know which voice(s) is currently playing.

**Voice Assign Mode switch-** Since each voice is monophonic (i.e., it can only sound at a time), the five-position slider switch selects how the voice responds to incoming note data. Note that Env 1 and Env 2 always retrigger with every note played regardless of assignment mode.

- **Mono/Last-** The voice responds to all incoming notes. The most recently played note takes priority.
- **Mono/Lo-** The voice responds to all incoming notes. The lowest note played takes priority. Env 1 and Env 2 will retrigger with every note played.
- **Mono/Hi-** The voice responds to all incoming notes. The highest note played takes priority. Env 1 and Env 2 will retrigger with every note played.
- **Poly/A and Poly/B-** Notes played are distributed amongst voices set to the same poly group (*Poly A* or *Poly B*). The maximum number of notes that can be played simultaneously corresponds to the number of voices set to the same poly bus. The manner in which incoming notes are assigned to voices depends on the switch settings in the *Poly Assign Mode* section, which we'll explain in some other far-flung part of this manual, once you've well forgotten all the stuff we just explained. Hooray!

Poly A and Poly B can be thought of as "lanes" or MIDI channels and are useful for creating "stacked" polyphonic patches. Typically you'd set voices 1-4 to *Poly A* and voices 5-8 to *Poly B*. Voices 1-4 would be used to create one sound (i.e. same parameter settings for voices 1-4), and voices 5-8 would be used for a different sound (again, with the same settings for voices 5-8). The end result would be a dual-sound stacked patch with four-voice polyphony.

**Voice Link 1-8 buttons-** These work in conjunction with the *Link Group 1* and *2* button groups in the bottom control section and allow parameters of multiple voices to be controlled using a single voice as a "master." This is one of Eight Voice's most killer features - it's so great, it has its own section: ***Link Groups 1 and 2.***

**Keyb switch-** When switched to the up position, the voice responds to incoming notes played from a MIDI controller or a DAW sequencer.

**Seq switch**- When switched to the up position, the voice responds to incoming notes from Eight Voice's onboard *Mini Sequencer*.

**If both the *Keyb* and *Seq* switch are in the off position, the voice is disabled and is dimmed.** Because there's a lot going on with Eight Voice, dimming inactive voices makes it a little easier to understand what's going on and which voices are currently making noise.

(This is the part of the manual you'll be reading with your tail between your legs when you get upset that the voice is "broken" and some smarmy Cherry employee (i.e. me) pastes a link into the internet forum. Don't be that guy!)

**If both the *Keyb* and *Seq* switch are in the on position,** the onboard Mini-Sequencer controls the voice **and** the keyboard will transpose the sequence. This is a pretty nifty feature, and we'll remind you all about it in the Mini-Sequencer section.

## Key Range

---

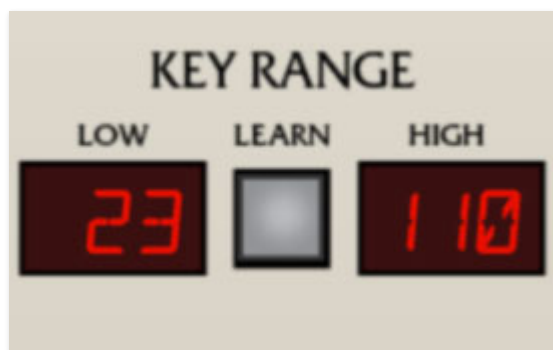

Key Range specifies the MIDI note range the voice will respond to. This is very useful, as it opens the door to keyboard splits and layering, which can get pretty awesome when combined with the mono and poly voice assign modes.

**Learn button and Low/High displays**- Key Range has only one super easy-to-use control, and that's the *Learn* button (in the immortal words of Beavis and Butthead, "if I wanted to learn, I'd go to thkool!"). These are displayed as MIDI note numbers.

To set a keyboard range, click the *Learn* button; the number in the *Low* display flashes. Hit the lowest keyboard note you'd like the voice to respond to. The number in the *High* display will now flash; hit the highest note you'd like the voice to respond to. The key range is now set and learn mode is

disabled. If you make a mistake, simply repeat the process. *Low* and *High* key range can also be set by clicking and dragging on the number displays.

To reset a voice's range to MIDI notes 0-127, simply double-click the *Learn* button.

***Setting Key Ranges with Poly Modes-*** When setting key ranges, all voices currently set to *Poly A* or *Poly B* mode will be set to the specified key range. This is easier to explain with an example - if voices 1, 2, 3, and 4 are set to *Poly A*, and Voice 1's key range is set, all four voices will be set to this range. The same goes for *Poly B*. We made it work this way because it would be confusing if you had to remember to set all voice modules used in a poly patch to the same key range. Additionally, any voice currently set to one of the poly modes can be used to set the range - in other words, in the preceding example, the range could be set with the *Key Range* controls in voice 1, 2, 3, or 4.

This "auto key range copy" function works **independently** for *Poly A* and *Poly B*, and 8 Voice will remember the current range settings for both as you change voice assign switch settings, as well as the mono key range settings for each individual voice.



# Output Section



**Pan-** Moves the sound of each voice between the left and right channels. We don't need to tell you what to do with a pan knob, but one super great Eight Voice trick is to create a homogenous eight-voice poly patch, then set the pans randomly for each voice. This is even neater if the tuning controls are minutely varied for each voice - beautiful stereo pads can be created this way.

**Solo-** The *Solo* button glows, and audio is disabled for all other modules. Other modules are also visibly dimmed.

If the voice is currently set to *Poly A* or *Poly B*, the number of voices of polyphony is temporarily reduced to only the soloed module. This is similar to the "hold" function of the original Oberheim Two/Four/Eight Voice instruments, and it makes sound editing much easier. If it *didn't* work this way, if you had four voices set to *Poly A*, for example, only every fourth note would sound the soloed module, which would make sound editing a drag (or you'd need to switch the voice assign switch to one of the mono modes).

Multiple voices can be soloed, and if they're set to *Poly A* or *Poly B*, their triggering will depend on the setting of the *Poly Assign Mode* switch. Generally speaking, it makes the most sense to solo one voice at a time when in one of the poly modes.

**Volume and output meter LEDs-** Obviously this affects the loudness of the voice, but do pay attention to overall master volume, as the cumulative volume of multiple voices can really stack up. The red meter LED will glow when things are getting too hot. You'll also notice that, in addition to the main *Voice* activity LED, the meters are useful for a quick visual reference of which voices are currently playing.

# Master Controls (Bottom Strip Controls)

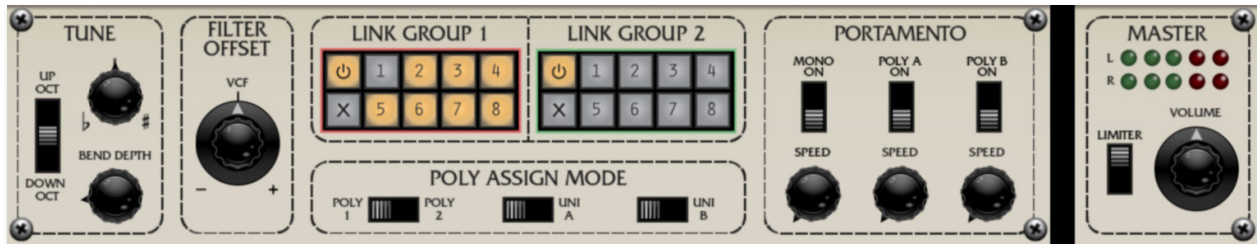

The controls in the bottom section are global, that is they affect *all* voices. These include master tuning, filter offset, voice linking, poly assign modes and more. Note that all master settings are stored individually, per-patch. Some of these sections are covered in other parts of this guide, we'll provide links in those cases.

Remember that the *Ctrl*, *Seq*, and *FX* view focus buttons in the top menu strip can be used to instantly zoom in and enlarge the bottom controls for easy editing.

## Tune

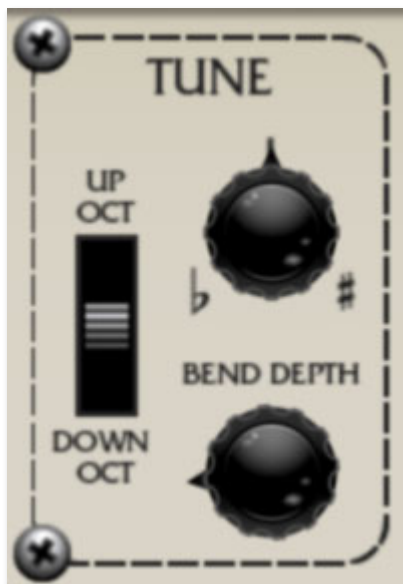

**Transpose switch**- This three-position switch transposes the entire instrument up or down one octave, with the middle position being "normal."

**Tune**- Allows fine-tuning of the entire synth up or down a semitone.

**Bend Depth**- Sets how Eight Voice responds to incoming MIDI pitch bend data. The pitch bend range can be set from zero up to one octave.

## Filter Offset

---



This acts as a master filter cutoff control for all eight voices. Moving does not affect the actual knob positions - like the original instrument's offset knob, it adds or subtracts CV from the cutoff setting of all modules, with the center position being zero. We recommend assigning this to hardware knob or slider control, or the mod wheel (see the [MIDI Controllers Setup and The MIDI Tab](#) section for information on how to do this; it's really easy).

## Poly Assign Mode

---



These switches affect voice assignment behavior when voices are set to *Poly A* and *Poly B* modes.

### **Poly 1 / Poly 2**

- **Poly 1**- Voice modules play in order of notes played. Let's say all eight voices are set to play in the same poly group; voices would play 1-2-3-4-5-

6-7-8, and when the 9th note was played, voice 1 would be stolen, then voice 2, etc.

- **Poly 2-** Voice modules play in order of notes played as above, but if a note is repeated it will always attempt to play the same voice. In a musical context, this is useful when playing a repeated bass note that you don't want to get stolen.
- **Uni A/Uni B-** When either of these switches are enabled, all voice modules set to *Poly A* or *Poly B* respectively will play in mono unison mode, that is, one note at a time. This is useful for making super-thick stacked sounds, or one-note "chords" by detuning voice modules. For more information on how Poly A and Poly B voice mode works, please see the [Voice 1-8 Assign and Key Range](#) section.

## Portamento

---



"Portamento" is just a fancy word for glide - that is, instead of notes instantly shifting from one pitch to the next, the pitch change is slurred, like a trombone (only less annoying). Eight Voice includes separate on/off switches and glide speed controls

**Mono On/Off and Speed-** The switch enables and disables portamento for voices set to *Mono/Last*, *Low*, or *High* note assign mode. *Speed* adjusts how quickly they glide from pitch to pitch, with zero being instant, and slower as the knob is turn clockwise.

**Poly A On/Off and Speed-** The switch enables and disables portamento for voices set to *Poly A* note assign mode. *Speed* adjusts how quickly they glide from pitch to pitch, with zero being instant, and slower as the knob is turn clockwise.

**Poly B On/Off and Speed-** The switch enables and disables portamento for voices set to *Poly B* note assign mode. *Speed* adjusts how quickly they glide from pitch to pitch, with zero being instant, and slower as the knob is turn clockwise.

***Some things you should know about Poly Portamento-*** It may have occurred to you that the concept of gliding from pitch-to-pitch in poly mode can get a little dicey depending on the number of notes being played, going into other notes, vis-à-vis the number of voice modules currently active. It's advisable to set the number of voices used in the poly patch to something close to the number of notes you'll be playing simultaneously (if possible). Also be aware that poly portamento behaves quite differently depending on the *Poly Assign Mode/Poly 1* or *Poly 2* setting - we find it's likely to behave more like you'd want when set to *Poly 2*, but definitely experiment to see which setting works best.

***The cool Poly Portamento A/B trick you should know-*** Earlier we mentioned using *Poly A* and *Poly B* to create stacked, dual four-voice patches. Enabling portamento for one poly group (but not the other) is a very pleasing effect, particularly when combined with the delay effect.

## LFO 2

---



LFO 2 is a global single LFO that can be configured to affect voice mod parameters via the switches in the voice modules. Please see the [LFO 1 and 2](#) section for more information.

## Mini Sequencer

---



The Mini Sequencer is a handy and flexible eight-step note sequencer. Please see the [Mini Sequencer](#) section for more information.

## Delay and Reverb Effects

---



Eight Voice includes syncable modulation delay and reverb effects. Please see the [Effects](#) section for more information.

## Master Section

---



The Master section includes a master volume for the entire instrument and stereo level meters. You'll want to keep this guy out of the red or else digital clipping can occur (which doesn't sound cool). Because Eight Voice is such a beast, sound can easily pile up and get loud - enabling the *Limit*er switch applies a transparent limiting effect to help prevent overloading.



# Link Groups 1 and 2

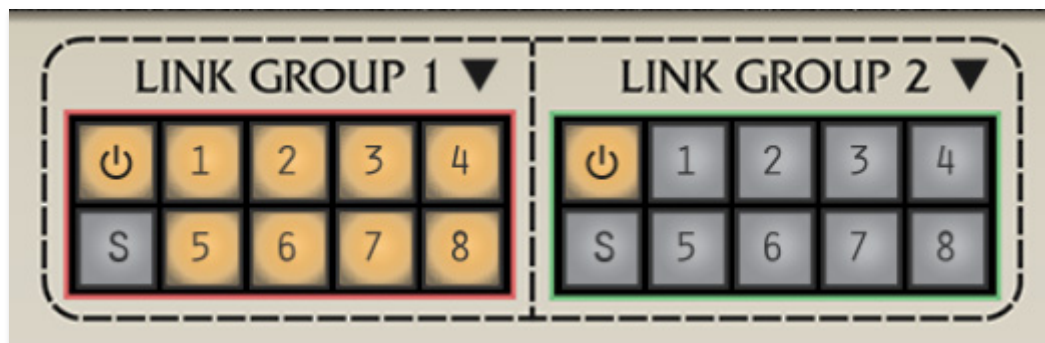

It would be fair to say that, along with the *Focus* controls, the Link Group controls are the "magic bullet" that transform Eight Voice's large and potentially nightmarish, multi-voice interface into a creative and fun-to-use walk in the park. (Because everyone walks in the park while playing giant polyphonic synthesizers.)

## Concept

---

As you probably know by now, Eight Voice is unique in that it's comprised of eight monophonic (i.e., one-note-at-a-time) synthesizer voice modules, each with an identical control set. Though other polyphonic synthesizers operate similarly "under the hood," that is, they contain separate synth voice modules for each note of polyphony, they usually have a common set of controls that affect all instances of a particular parameter. For example, the front panel typically has a single filter cutoff knob, but when turned, it's actually controlling the filter cutoff of *all* synth voices simultaneously. This is called a *multiplexed* control. It's convenient, and results in a far more compact user interface (not to mention requires far less parts in a hardware instrument). It's an ideal arrangement for a creating homogenous polyphonic patches, that is, sounds where every note sounds the same. The tradeoff is that a great deal of flexibility is lost.

The actual reason original Oberheim instruments didn't utilize multiplexed single parameter controls was that the ability to digitally control multiple parameters simultaneously simply didn't exist in the mid-70s. But the multiple-voice module arrangement offered some unique sound opportunities, mainly the ability for each polyphonic note to sound slightly (or greatly) different. In fact, this was the Achilles' heel of the original instruments - imagine trying to tune 16 wonky analog oscillators! (And



imagine doing it in front of 10,000 people - brave 70s arena-rock bands like The Doobie Brothers, Rush, and Styx did.)

As you'll see, Eight Voice's Link Groups function offers the best of all worlds - the ability to link the controls of multiple modules, selective disabling linking for dialing in subtle parameter changes, and the choice of absolute or relative movement of linked controls. Now how much would you pay?!?

## Link Group Controls

---

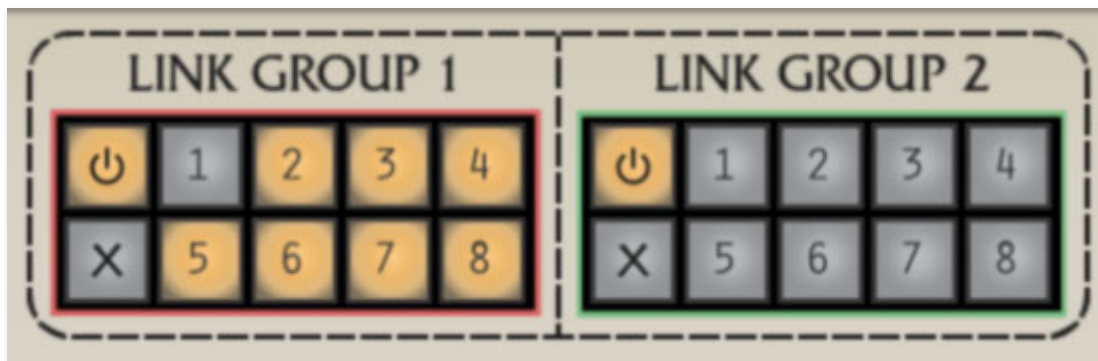

The *Link Group 1* and *Link Group 2* controls are found in the bottom section, beneath the giant "Eight Voice" badge. Toggling a group's number buttons "links up" the controls for the selected voice modules. For example, if the 1 and 2 buttons are selected in one of the link groups, moving any of Voice 1's controls will cause Voice 2's corresponding control to instantly jump to the same value and move in lock-step. When using voice linking, there is no "master"- controls may be adjusted from **any** linked voice control, and all others within the link group will move correspondingly.

**When voices are linked, linked parameters only change when specific controls are altered.** In other words, selecting voice link buttons won't instantly copy all of its parameters to a newly linked voice, so you won't need to worry about nuking the settings of other modules when configuring *Link Group* settings.

(That said, voice parameters can easily be copied from voice to voice by clicking the upside-down triangle copy menu at the upper-right of each voice, or by right-clicking in any non-control area of a voice module. We thought of eeeeeverything.)

**Link Group 1 and 2-** Eight Voice includes two separate and independent link groups. Why two? The most obvious use would be for creating dual, layered four-voice patches (using the *Poly A* and *Poly B* voice assign

settings), using one link group for one half of the patch, and the other link group for the other. But the dual link groups have other uses as well - perhaps when using keyboard split, with two or more linked voices for a left-hand bass sound, then using the remaining voices in poly mode for right-hand chords.

A voice can only be a part of one of the link groups at any time; if the voice is already active in a link group, selecting it will disable it in the other group and enable it in the currently selected group.

**Link Group "Power" button-** The button at the top left temporarily disables the link group; the *Power* button will go dark, and the currently selected voice number buttons will dim. The *Power* button is particularly useful if you've created a linked patch, but you'd like to alter one or more parameters of particular voices without affecting others, for example, very slightly detuning or panning individual voices of poly sounds is a great way to spatialize and add dimension. When you've made the desired adjustments, simply click the *Power* button again to enable linking.

**Link Group "X" cancel button-** This button resets all link number buttons to the disabled position.

## Absolute/Relative Linking and Randomization

---

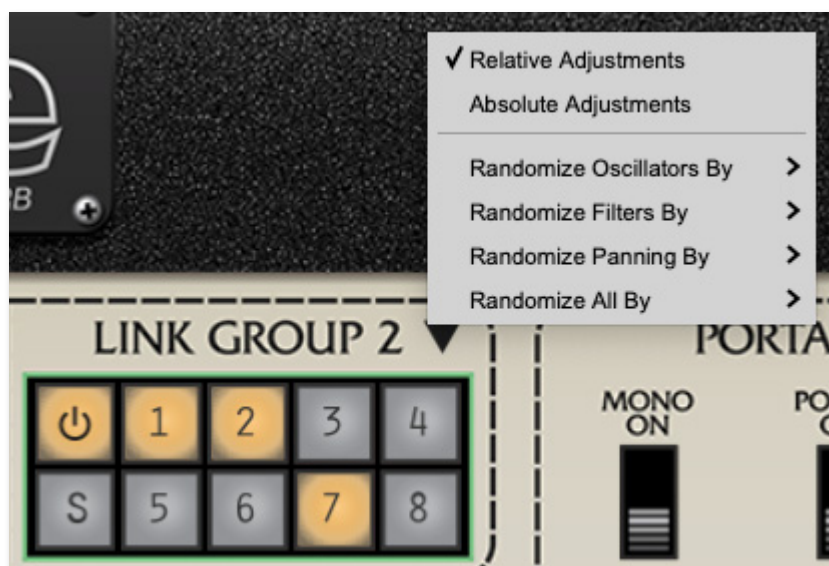

Clicking the disclosure triangles next to the *Link Group 1/Link Group 2* panel labels displays a pop-up menu specifying how linked controls move together. It also offers a number of parameter randomization shortcuts.

**Relative/Absolute Adjustments**- By default, linked controls are in *Relative Adjustments* mode. This means control setting offsets are maintained when a control is moved. If the pop-up is set to *Absolute Adjustments* mode, linked controls immediately jump to the value of the control being manipulated.

**Randomize**- These let you quickly add a percentage of randomization to oscillator, filters, voice panning settings, or all three. The *Randomize* functions are designed to subtly (or not subtly) affect parameters that typically drift a bit in a real analog synth. They're not intended for creating totally arbitrary wacko patches - the idea is to add the sort of minor instability and liveliness that makes vintage analog instruments sound and "feel" great. **Randomization only affects voices with link buttons currently enabled.**

Following are the parameters affected by randomization:

- **Randomize Oscillators By**- Randomizes VCO 1/VCO 2 *Frequency/Detune* (does not affect octave/footage setting) and VCO 1/VCO 2 *Pulse Width* settings by 2.5%, 5%, 10%, or 15%.
- **Randomize Filters By**- Randomizes VCF *Frequency* and *Resonance* settings by 2.5%, 5%, 10%, or 15%.
- **Randomize Panning By**- Randomizes the *Output* section *Pan* knob setting by 2.5%, 5%, 10%, or 15%.
- **Randomize All By**- Randomizes all aforementioned oscillator, filter, and panning settings by 2.5%, 5%, 10%, or 15%. It does not actually affect "all" Eight Voice parameters.

## Voice Module Voice Link Buttons

---

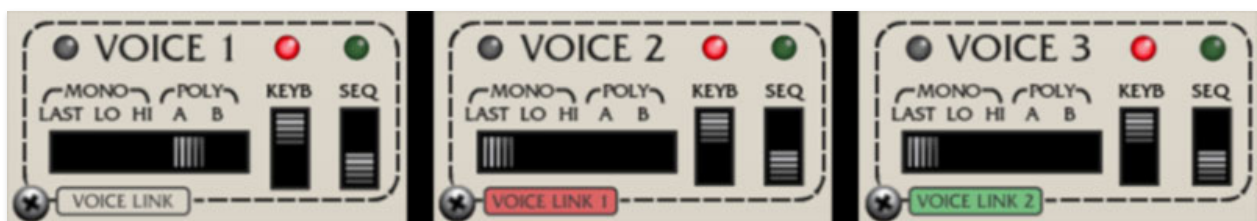

While taking the *Link Group 1* and *2* buttons for a spin, you may have noticed the *Voice Link* buttons at the bottom left of the voice modules changing color. These are additional *Voice Link* buttons, and allow enabling and disabling voice linking on a per-voice basis. These default to off (no color) and will cycle through *Voice Link 1* (red), *Voice Link 2* (green), and back to off

when clicked. The corresponding number buttons are also activated in the *Link Group 1* and *2* section at the bottom left of Eight Voice.

# Mini-Sequencer



The Mini-Sequencer may appear to be a basic eight-step sequencer, but it has a number of powerful features that might not be obvious at a glance. Let's go over its controls.

**Rate knob and LED**- Adjusts the speed from 0.15 to 30 Hz (with *Sync* switch disabled).

**Sync**- Enabling the *Sync* switch locks the Mini Sequencer's clock to either DAW project tempo (if Eight Voice is used within a DAW) or to the tempo setting in the top menu strip (if Eight Voice is being used as a standalone app). When *Sync* is enabled, the *Rate* knob moves in steps from 8 beats, up to 1/64th-note triplets. I once did shots with some triplets, but that's not important right now.

**Gate +V**- Toggling this on locks the sequencer envelope gate CV on. It's intended as a sort of "freeze" mode in order to set the pitch voltage knobs 1-8. Use *Gate +V* in conjunction with the neighboring *Step* button. Depending on the patch, you may need to temporarily increase the envelope sustain levels and/or filter cutoff to hear sound.

**Step**- Manually steps through the pitch voltage knobs. The current step will jump back to 1 dependent on the *# Of Steps* control setting. The envelope gate voltage will be held high as when the *Step* button is held.

**Keyb Step**- Advances the sequencer one step every time a note is played within the key range(s) of any voices with the seq switch currently enabled. This basically means that if you have one more voices zoned to limited range for a sequencer pattern, and some other part of the keyboard zoned for live playing, the live playing keyboard zone won't advance the sequencer, which is how you'd want it to work, we promise!

**Stop**- Stops the sequencer when in *Run* (play) mode.

**Run-** Initiates playback of the sequencer. Playback always starts from step 1, regardless of current sequencer step. The *Run* button can be clicked during playback for instant restart.

**Keyb Gate-** Enables the sequencer *Run* button for as long as a note is played within the key range(s) of any voices with the seq switch currently enabled.

**Quant-** Rounds off voltage settings for the pitch voltage knobs to the nearest 1/12 volt, i.e. semitones. This tremendously simplifies creating in-tune melodies.

**Octave Range-** Sets the range for the pitch voltage knobs to one, two, or five octaves.

**CV/Gate Enable Knobs 1-8 and LED-** Sets the voltage level (i.e. pitch) for each sequence step. If the *Quantize* switch is off, these will be fully variable; if the *Quantize* switch is on, they step in semitone increments. The pop-up tooltip flags will display the pitch. ***Setting a pitch voltage knob to zero disables the gate voltage for that step***, effectively creating a "skip" step that doesn't trigger the envelope generators - this considerably increases the sequencer's musicality. ***If a sequencer step isn't making any sound, make sure it's not set to zero.*** The LED above each step illuminates to show the current sequencer step.

**# of Steps-** Sets the overall length of the sequence pattern. A setting of one can be useful for simple "auto-repeat" note effects, great for sixteenth-note industrial bass lines, for example (in case you're doing that Frontline 24haujobb gig).

**Gate Length-** Sets the duration of the gate voltage routed to the envelope generators. The percentage displayed in the pop-up tooltip flag refers to its length compared to the length of the step, for example, a setting of 50% would mean the gate voltage would last half the length of the step. This is displayed in percentage, because the actual time will be different depending on the current *Rate* setting.

## Using The Mini-Sequencer

---



**The *Seq* switch in a voice's voice assignment section (at the bottom left of each voice module) must be enabled for the sequencer to work** - if no *Seq* switches are currently on, the sequencer will run, but it won't be routed to anything. (Don't worry, this won't void your warranty, but the support dept. might give you a gentle ribbing.)

If the voice's *Keyb* switch is disabled, the voice will ignore incoming MIDI controller and DAW note data and respond *only* to the sequencer. If both the *Keyb* and *Seq* switches are enabled, incoming MIDI notes and sequencer control voltages are combined - this means that notes from a MIDI controller or DAW will transpose sequencer playback (which can be really useful). The *Keyb* and *Seq* switches can be engaged in any combination across different modules.

***About Sequencer Playback and Key Ranges***- The Mini Sequencer will transmit to the entire note range of any *Seq* switch-enabled voice, regardless of *Key Range* settings.



# Effects Section



Eight Voice includes high-quality stereo modulation delay and reverb effects. With its built-in modulation, the delay is particularly flexible, capable echos, flanging and chorus effects.

## Delay



**On/Off**- Enables and disables the delay effect.

**Time knob / LED / digital display**- Sets delay time, from 1 to 2000 ms. If the *Sync* button is enabled, time settings snap to synchronized note values (see *Sync* switch below). The LED beside it flashes at the current rate and the number display shows the exact time.

**Sync**- Enabling the *Sync* switch locks the delays time to master tempo. When engaged, the *Time* knob snaps to note values ranging from 1/64th note triplet to 8 beats. *Sync* mode locks to the tempo in the top toolbar when using the standalone version or the current project tempo when using the plug-in version in a DAW.



**Spread**- Simultaneously subtracts and adds up to 20ms of delay time to the left and right channels respectively, creating a wide stereo effect. It also prevents echoes from "piling" up in the center of the image. Note that the subtracted and added delay effectively changes the overall delay time setting with each repeat, so long delays combined with high feedback settings can become noticeably off time, so we recommend setting *Spread* to zero if you're using high feedback echoes with many in-time repeats.

**Feedback / Invert switch**- Routes the output to the input for additional repeats. The *Inv* switch flips the phase of the delay signal. You won't hear much difference between the *Inv* switch positions with standard repeating delays, but inverting the phase is noticeable with delay times in flanging range (15ms or less) and the feedback knob cranked (more on this in the *Mod* section below).

**Mod Controls**- These allow modulation of the delay time using the Delay section's internal sine-wave LFO (this is separate from *LFO 1* and *LFO 2*). The addition of time mod enables flanging and chorus effects as well as wilder, swooping pitch effects at more extreme settings. Note that the digital time display doesn't change as modulation varies the time (if it did, the time display wouldn't be readable).

- **Rate knob and LED**- Varies the speed of time modulation from 0.15 to 30 Hz. The LED flashes at the current mod rate.
- **Depth**- Mod depth affects how much the time is varied by.

**Creating Flanging and Chorus effects** - The primary purpose of the *Mod* controls are to allow flanging and chorus effects. Flanging and chorus are closely related; the difference is that flanging typically creates metallic and/or jet flyby "whooshing" sounds, whereas chorusing produces a gentle, mildly detuned doubling effect.

To create a flange, set the *Time* to 15ms or less, *Feedback* over 70%, slow *Mod/Rate*, *Mod/Depth* over 60%, and *Dry/Wet* to 50%.

To create a chorus effect, set the *Time* around 20ms, *Feedback* at 0, *Mod/Rate* around 0.60 Hz, *Mod/Depth* 6% (this is actually center knob position), and *Dry/Wet* to 50%. Engage the *Spread* switch for a nice stereo chorus.

**Damp**- Attenuates high frequencies as the slider amount is increased. Not only does this create more natural sounding decays, it also reduces the "stacking" effect that occurs with high feedback levels.

**Dry < > Wet**- Balances the level of dry and wet signal. Setting the knob to the center position gives an equal 50/50 balance of wet and dry signal.

## Reverb

---



**On/Off**- Enables and disables the reverb effect.

**Decay**- Sets the overall length of reverb; the actual time varies dependent on the reverb type.

**Reverb Type - Hall/Room/Spring**- Allows selection of three different types of reverb.

**Damp**- Attenuates high frequencies as the slider amount is increased for more natural reverb sounds.

**Dry < > Wet**- Balances the level of dry and wet signal.

# Voice Duplication

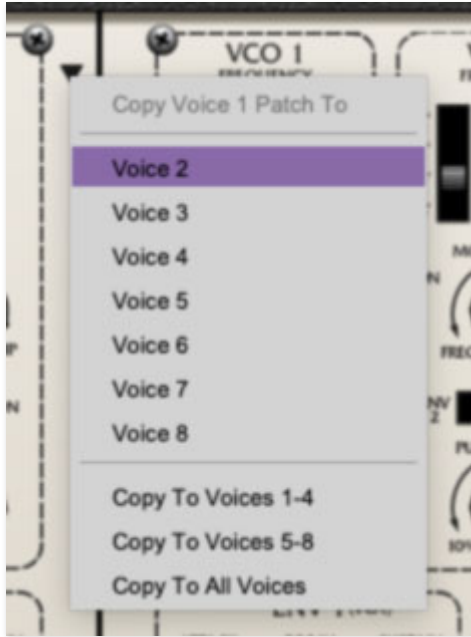

These pop-up menus allow fast and easy copying of all parameters of a voice to one or more other voices. This works really well in conjunction with voice linking - use voice linking to set single parameters across multiple voices, and the voice duplication menu to copy all parameters of a voice to other voices.

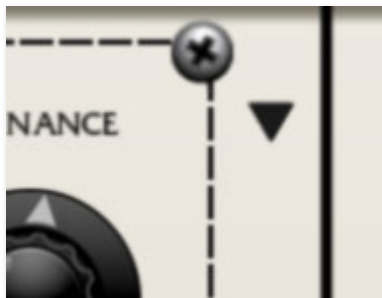

The menu can be opened either by clicking the triangle at the upper-right of each voice or by right-clicking in any non-control area of a voice module. Be careful, because the duplicate voice command will overwrite all parameters of the voice you're writing to.

The *Copy To* options are as follows:

**Voice 1**

**Voice 2**

**Voice 3**

**Voice 4**

**Voice 5**

**Voice 6**

**Voice 7**

**Voice 8**

**Copy To Voices 1-4-** This is useful when creating four-voice polyphonic patches, particularly for dual four-voice, layered poly patches.

**Copy To Voices 5-8-** Useful for creating the "other half" of four-voice polyphonic patches.

**Copy To All Voices-** Copies to all voices at once. Use this to quickly make eight-voice polyphonic patches.

Note that the current voice (i.e., the voice being copied) won't show in the menu.

# MIDI Controllers Setup and The MIDI Tab

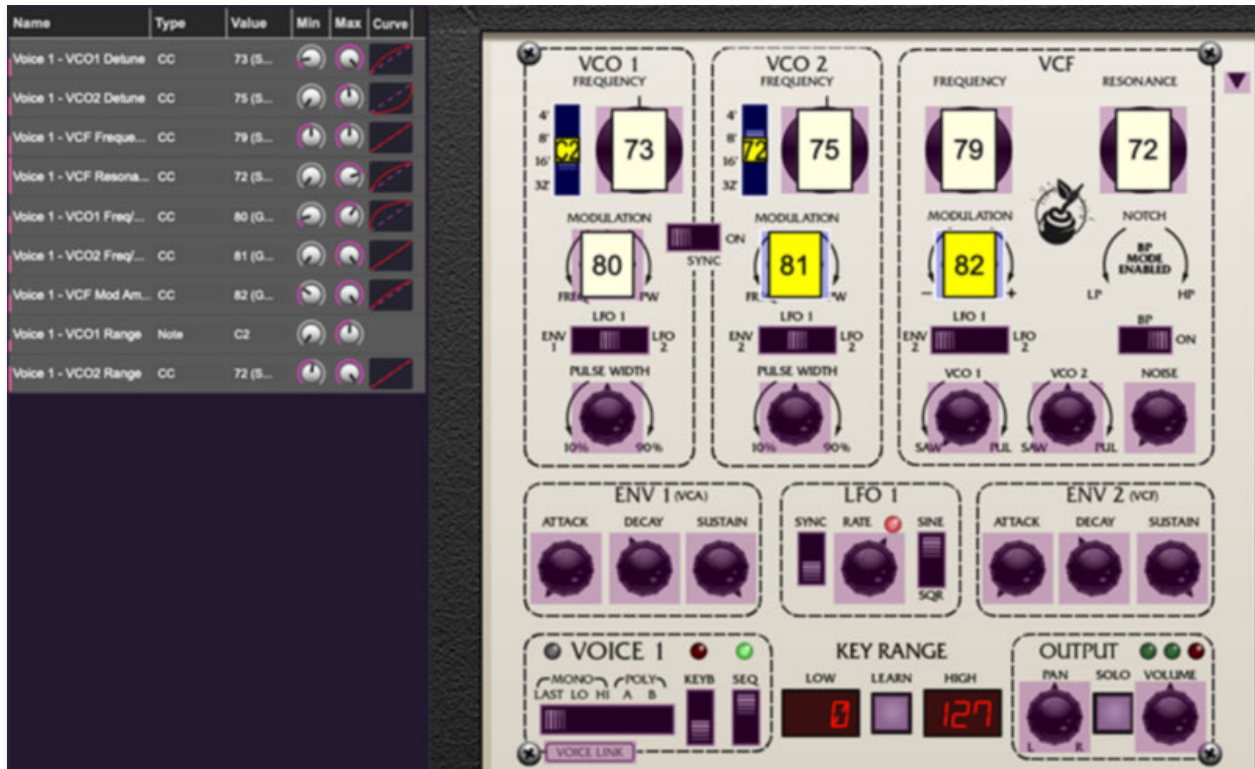

Assigning internal and external hardware controls adds a whole new dimension of control and musicality to patches, and it's really easy to do. The MIDI Tab is where all controller assignments can be viewed and tweaked. First we'll show how to assign an external hardware controller to an Eight Voice control, then we'll go over all parameters in the MIDI Tab.

**Note that all Eight Voice voice module controls are independently assigned.** For example, assigning a MIDI hardware controller to Voice 1's *Resonance* knob, **only** affects the *Resonance* knob for Voice 1. However, one MIDI controller can easily be assigned to multiple controls (the *Resonance* knobs for any or all eight voice modules, for example).

## Basic External Hardware Control Assignment

This is the quick, "I just want to assign a hardware control right now!," section. We recommend reading this entire section to best take advantage of

Eight Voice's swift MIDI control assignments. We also recommend reading "*The Shining*" by Stephen King, but that's not important right now.

In this example, we'll assign a hardware slider control to Voice 1's filter cutoff *Frequency* knob.

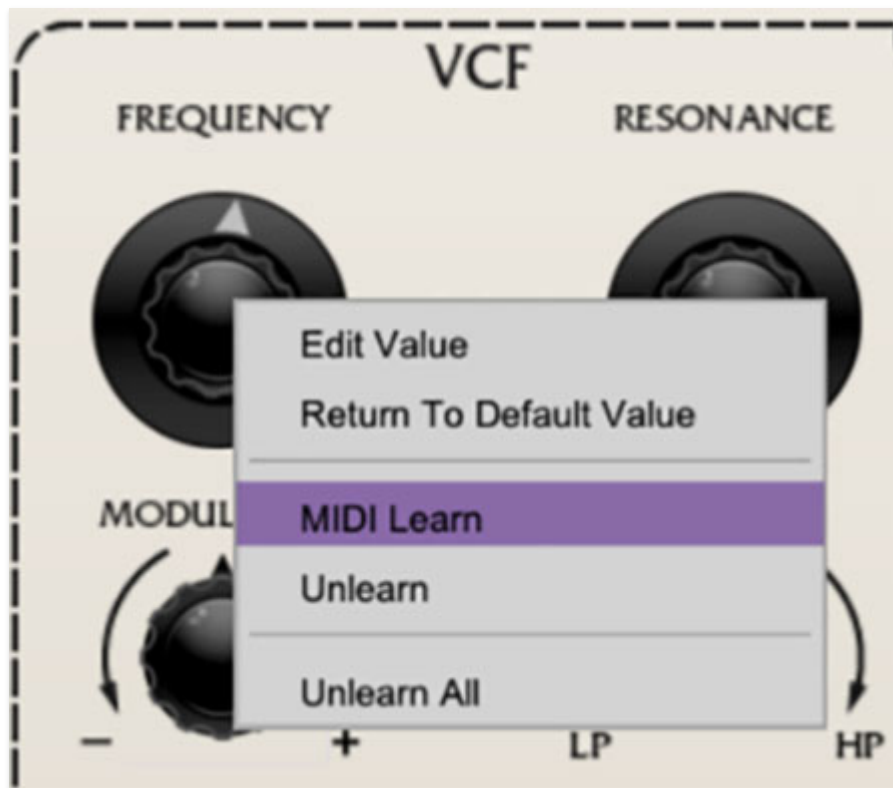

Begin by right-clicking on the *Frequency* knob in Voice 1's *VCF* section and selecting *MIDI Learn*. A transparent purple overlay appears over the knob indicating that it's in learn mode. Now move the desired hardware control device. The purple overlay disappears and the hardware control will move the onscreen knob. If you get cold feet (or accidentally put the wrong control into learn mode), learn mode can be aborted by right-clicking and selecting *Stop Learning*.

This is the basic procedure for assigning hardware controllers to almost any Eight Voice control.

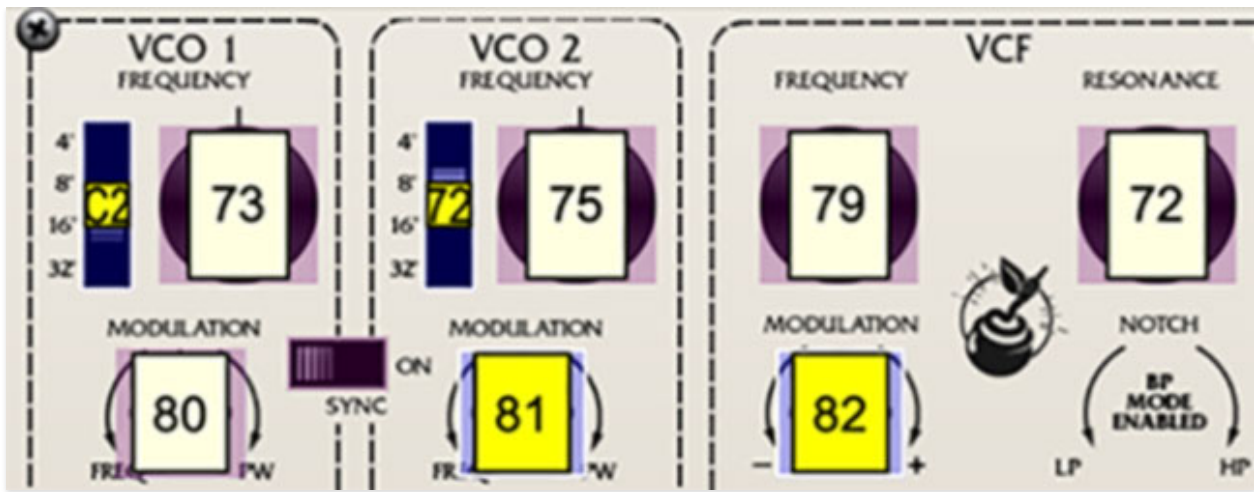

When in MIDI learn mode, any previously assigned controller numbers will show in squares. These indicate the MIDI continuous controller number of the assigned hardware control (these are also displayed in the *MIDI* library tab at left).

Once a MIDI controller has been assigned, in addition to real-time control of an Eight Voice parameter, you'll also be able to record and play back controller data from a DAW.

## The MIDI Tab

This is command central for all MIDI controller assignments. Here you'll be able to see information about all currently assigned controllers and adjust control ranges.



To view or hide the MIDI Tab, click the *MIDI* button in the top toolbar.

Name	Type	Value	Min	Max	Curve
Voice 1 - VCO1 Detune	CC	73 (S...			
Voice 1 - VCO2 Detune	CC	75 (S...			
Voice 1 - VCF Freque...	CC	79 (S...			
Voice 1 - VCF Resona...	CC	72 (S...			

**MIDI Learn button**- This is almost exactly the same as enabling MIDI learn mode by right-clicking a control. Click the *MIDI Learn* button to enter learn mode (all controls turn purple). Unlike right-clicking on specific knobs, where Eight Voice automatically exits controller assignment mode, clicking the *MIDI Learn* knob "stays on" to enable assignment of multiple hardware controls. This is handy for quickly assigning a bunch of knobs, sliders, or the buttons of a grid-style controller.

To assign multiple controls, click *MIDI Learn*, click an on-screen control, move the desired hardware knob or slider, continue clicking and assigning on-screen controllers until all desired controls are assigned, then click *Stop Learning* to exit learn mode.

Remember that a single hardware knob/slider/button isn't limited to controlling just one parameter - a single hardware controller can simultaneously operate as many controls as you'd like. Combined with the MIDI Tab's controller range and inversion controls explained below, this can be a very powerful and customizable way to control parameters.

### **MIDI Tab Columns**

**Name**- Displays the name of the parameter being controlled.

**Type**- There are five possible types of controller automation in Eight Voice:

- **Note**- Notes played on a MIDI keyboard controller, expressed as C-1 to G9
- **CC (MIDI Continuous Controller)**- The standard 128 MIDI controller numbers as defined in the MIDI spec. More specifically, these are the controllers transmitted by hardware knob and slider controls. MIDI CC's can be used to control parameters in real-time or recorded and played back within DAW software.
- **MMC (MIDI Machine Control)**- The MIDI control protocol for tape machine-style transport controls. Back in the dark ages, this was used to control wonky old Tascam and Fostex reel-to-reel monsters, but it's useful if your MIDI controller has tape-style transport control buttons.
- **Pressure**- Most modern keyboard controllers transmit controller data when keys are pressed and released as they're held down. The vast majority of keyboard controllers with aftertouch transmit "mono" aftertouch only; in other words, aftertouch data is the sum of all keys to one single data stream. Note that Eight Voice only responds to mono aftertouch.



- **Key**- This allows keys of the computer QWERTY keyboard to act as button controls for Eight Voice's onscreen controls.

**Value**- Displays the specific automation controller. In the case of a *Note* this would show a MIDI note number (C-1 to G9, for a MIDI CC, this would be the MIDI CC controller number, etc. Clicking on the value opens a pop-up menu where all values are displayed and can be selected.

**Min**- Sets a limit on the lowest value any automation control can set a mapped controller to. This actually recalibrates the range of the automation controller to the remaining parameter range.

**Max**- Sets a limit on the highest value any automation control can set a mapped controller to. This actually recalibrates the range of the automation controller to the remaining parameter range.

**Curve**- These allow the customization of how incoming MIDI CC controls affect the movement of Eight Voice's onscreen controls, ranging from exponential to linear to logarithmic curves.

**Super Tricky Min-Max Tricks and Eight Voice's "Two-Way" knobs**- Not only can parameter ranges be limited via the *Min* and *Max* knobs, mapped control destinations can be completely inverted by setting the *Min* knob all the way up and the *Max* knob all the way down (or anywhere in between).

Limiting and inverting parameter ranges with the *Min/Max* controls is particularly useful when multiplexing a single hardware control to operate multiple parameters. Along with the *Curve* control, the customization possibilities are super flexible.

---

**Assigning Hardware Knob and Slider controls to Eight Voice's Bi-directional Knob Controls**- Sets many of Eight Voice's controls have a "zero" point at center position, and increase when moved left or right (oscillator and filter Modulation depth, and VCO 1/2 levels in the Filter section), you'll notice that assigned controllers will always start at the onscreen knob's full left position, which will likely not be the desired start position.

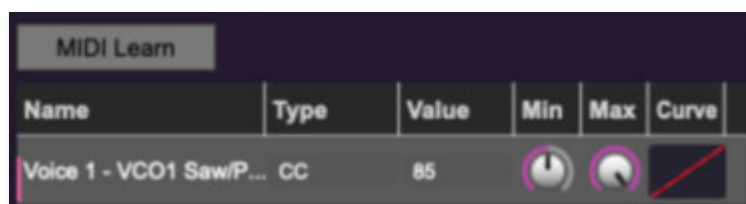

**Example 1 / Center Zero to Full Right-** Here we'll assign a hardware knob or slider to vary Filter/VCO 1's pulse wave volume from zero to max. Assign the desired hardware knob or slider by right-clicking the Filter/VCO 1 *Saw/Pulse* knob, selecting *Learn* and moving the hardware knob or slider. Now click the *MIDI* button in the top purple menu strip to open the left-hand MIDI tab. In the *Voice 1 - VCO Saw/Pulse* column, set the *Min* value to 50%. Minimum setting on the hardware control will now set Filter/VCO 1 *Saw/Pulse* to its center/zero position.

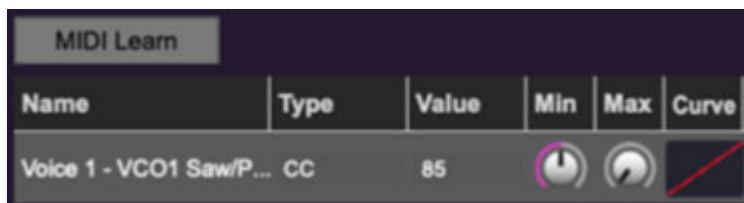

**Example 2 / Center Zero to Full Left-** Let's say you wanted a hardware knob or slider to adjust Filter/VCO 1's saw wave volume from zero to max - as with the example above, we'll need the lowest controller value to correspond to the onscreen knob's center position *and* we need to invert the incoming controller data so that increasing the control value moves the onscreen control counterclockwise.

Assign the desired hardware knob or slider by right-clicking the Filter/VCO 1 *Saw/Pulse* knob, selecting *Learn* and moving the hardware knob or slider. Now click the *MIDI* button in the top purple menu strip to open the left-hand MIDI tab. In the *Voice 1 - VCO Saw/Pulse* column, set the *Min* value to 50%, and the *Max* value to 0%. Minimum setting on the hardware control will now move Filter/VCO 1 *Saw/Pulse* to its center/zero position, and increasing it will rotate the onscreen knob counterclockwise to increase the saw volume.

---

## MIDI Tab Column Configuration

### Right-Click Menu

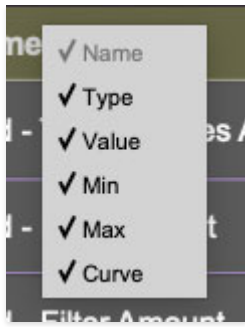

Right-clicking anywhere in the top row (*Name, Type, Value, etc.*) displays the column configuration menu. Checking/unchecking these allows hiding and display of each column. This has no effect on assignments.

## MIDI Tab Parameters Right-Click

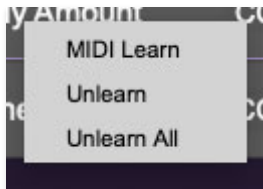

Right-clicking on an assigned parameter opens the menu above.

**MIDI Learn**- This is used to change the controller assigned to a particular parameter.

**Unlearn**- Deletes the selected automation parameter.

**Unlearn All**- Deletes all controller assignments for the patch. Eight Voice will display a warning dialog prior to deletion in order to thwart potential unlearn-related disasters.

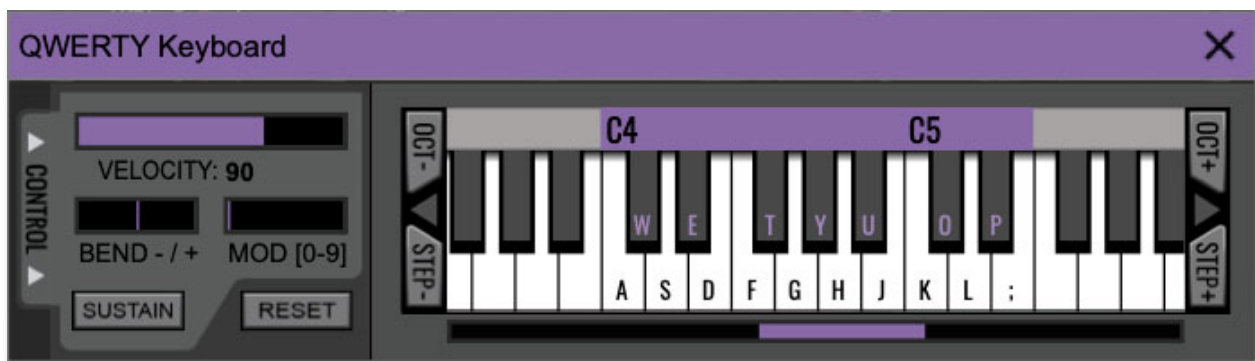

If you don't have a MIDI keyboard attached to your computer, the standard QWERTY computer keyboard can be used to play notes - we're pretty sure you've got one of those! We'll refer to this as the "MTK" because acronyms sound cool and I'm a lazy typist! Following is a list of MTK keyboard modifiers and functions:



**Opening and Closing the MTK** - click the the circular keyboard icon in the top toolbar. To close the MTK, click the keyboard icon in the top toolbar, or click the *X* in the top right corner.

**Play Notes**- To trigger notes, simply press the corresponding computer keyboard key or mouse click the onscreen keys.

**Adjust Currently Visible MTK Range**- Slide the purple scroll bar horizontally to adjust the currently visible keyboard range.

**Adjust Overall Visible Keyboard Range**- Clicking and dragging the right edge of the MTK window allows the overall size of the window to be adjusted. This lets you view more or less of the onscreen keyboard. Note that the MTK window's borders cannot exceed the overall outside dimensions of the Eight Voice window.

**Shift Range Up/Down Octave**- Click the *Oct-* and *Oct+* buttons at the top left and right of the onscreen MTK. The current range is displayed above the keyboard.

**Shift Range Up/Down Semitone**- Click the *Step-* and *Step+* buttons at the bottom left and right of the onscreen MTK. The current range is displayed

above the keyboard.

**Hide/View Controllers-** Clicking *Control* at the far left hides and displays velocity, bender, mod, and sustain control parameters. Hiding the control view makes more space available for the keyboard.

**Pitch Bend-** To pitch a note or notes, press the + or - computer keyboard keys while playing a note. Notes will bend up to an octave. Notes can also be pitchbent by clicking the mouse in the *Bend* area.

**Mod Wheel-** To add mod wheel modulation, press the number keys from 0-9 (above the character keys) while playing a note. The modulation amount will vary from none (0) to full modulation (9). Note that modulation will "stick" at the selected number; to disable modulation, click the 0 key. Mod can also be engaged by clicking the mouse in the mod bar area.

**Sustain-** The *Sustain* button mimics the functionality of a standard sustain pedal. Click the [TAB] key to engage sustain, or [SHIFT]+[TAB] to lock it. The *Sustain* button can also be engaged by mouse clicking it.

**Reset-** Initializes all MTK parameters including keyboard range and control parameters.

# Settings

Clicking the settings gear opens a window with multiple tabs for configuring various "under-the-hood" settings. These are mostly set-and-forget kind of parameters - all the stuff you'll usually see on the front panel, as it should be!

## General

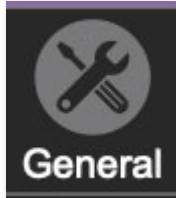

- **Add Undo For Control Changes With The Mouse**- Enabling this allows undo of knob, switch, and button adjustments. You'll want this on if you want the ability to undo all aspects of patch editing and programming.
- **Load Last Preset On Startup (Standalone Only)**- Automatically loads the last preset used when Eight Voice standalone version is started.
- **Create A Log File For Usage**- This creates a text doc of all of Eight Voice's internal and routines during use. It is mainly intended for our tech staff should you experience any issues. Clicking *Show Log Folder* opens the folder containing Eight Voice log file docs.
- **Preset Folder**- Displays the current location of Eight Voice's sound presets. This can be changed by clicking and typing in the field.
  - **Browse...** - Displays the current location of preset folder in the file manager.
  - **Set Default**- Sets the current displayed *Preset Folder* path as the default location
- **Clear Cache Files**- Deletes all log files, temporary sounds, and the image cache.



# Interface

Allows customization of Eight Voice's user interface settings.

- **Reset To Default Window Size-** Resets the Eight Voice workspace to default size. Use this to reset the window size if the window somehow becomes too large for your display and can't be resized (pretty sure we squashed that bug a while back though!).



- **Theme-** Allows selection of two different color schemes - *Classic* or *Black*. They're rare but we've actually seen some real-deal black Oberheims in the wild.
- **Tooltip Delay-** Tooltips are those informative bits of text that pop up when hovering over a control (go ahead and try it, we'll wait...). The *Tooltip Delay* setting defines how long you must hover before the tooltip pops up.
- **Knob Movement-** Defines which how mouse movements related to turning onscreen knobs. It defaults to *Vertical Drag*, but can be changed to *Horizontal Drag*, or *Rotary Drag* if you're having trouble with your vintage Mazda.

- **On Control Double-Click-** Defines what happens when the mouse is double-clicked on a control. If *Edit Value* is selected, an exact number can be entered by typing the number and hitting [ENTER] or [RETURN]. If *Sets Default Value* is selected, double-clicking a control resets it to its default value.
- **Mouse Wheel Adjusts Control Value-** Enabling this lets you adjust knob, slider, and switch values by moving the mouse wheel. This works great with a standard mouse wheel, but you'll want to disable it if you're using an Apple Magic Mouse (which will move the control AND scroll the window).
- **Show Tooltips When Adjusting Controls With Mouse-** Displays parameter tooltips/values when the mouse is hovered over a control or as a control is moved with mouse button down.
- **Show Tooltips When Automating Controls-** Enabling this causes control tooltip flags to show when automation data is being received.
- **MIDI Program Changes Should Change Current Preset-** Allows MIDI program change messages to change Eight Voice patches.
- **Ask To Save Modified Presets-** This opens a dialog window asking if you'd like to save changes if a patch has been edited and a new patch is selected. If you're the type that likes to click through presets and tweak a control here and there, it can be annoying to have a window pop-up asking if you'd like to save every time you switch presets - if you're that person, keep this off.
- **Remember MIDI Mappings For New Plug-in Instances-** When enabled, Eight Voice remembers all MIDI Tab controller settings.

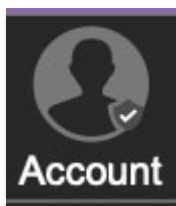

## Account

Settings for your personal login information and account.

- **Email-** Displays the email address of the current login.



- **Update Login Info**- This is it... the place to get real-time updates about Kenny Loggins. Ok, we made them up... clicking this opens the same email and password login screen you'll see when initially launching Eight Voice.
- **View Account Settings**- This opens your personal account page on the Cherry Audio Store website containing information about modules purchased and more.

## Software Update

- We often fix bugs and make improvements; below are options defining how Eight Voice handles updates.
- **Check For Update**- Click this to see if an updated version of Eight Voices available.

### Status-

- **Automatically Install Updates**- Updates are automatically downloaded and installed.
- **Ask Before Installing Updates**- By default, Eight Voice automatically downloads new versions of modules when available. Checking this box defeats automatic updates and will ask if you'd like to install updates when they become available.

We'll never make changes that can potentially "break" existing patches but we recommend enabling *Ask Before Installing Updates* if you're using Eight Voice for live performances or other "mission critical" situations.

- **Never Install Updates**- Eight Voice never automatically installs updates.
- **Show Updates On Toolbar**- Checking this will display an icon in the toolbar next to the logo letting you know there's an update available.

**Show Notifications From Cherry Audio**- We occasionally will fire off in-app advertisements; disabling this checkbox will hide them. We hate repetitive, annoying ads as much as you, so we won't use this feature too often. When we do, it'll be for something super cool (like a killer sale), so we recommend leaving it on.



## Audio/MIDI

Settings for audio and MIDI hardware input and output. **This tab is only visible in the standalone version of Eight Voice.**

- **Output-** Use this drop-down menu to choose a physical audio output source. This defaults to *Built-In Line Output*, i.e. your computer's onboard system audio, but you'll get better fidelity with an external professional audio interface. The biggest audible difference is usually reduced background noise or hum, but external audio hardware also offers greater flexibility in terms of number of inputs and outputs and built-in mic or low-level instruments pres (i.e. electric guitars). These are especially useful if you're using Eight Voice's external inputs to process sound. The *Test* button will produce a sine wave when clicked; this will help with troubleshooting, aka, "WHY THE HECK ISN'T THIS MAKING ANY NOISE?!?"
- **Sample Rate-** This sets Eight Voice's global sample rate. Lower sample rates offer better performance, but if you have a fast computer, high sample rates may offer slightly improved fidelity.
- **Audio Buffer Size-** As with any digital audio app, this defines performance vs. note latency, and will largely depend upon computer CPU speed. A professional external audio interface will almost always exhibit better performance than "built-in" system audio. Lower settings will result in less latency (in the form of faster response to notes played), but will increase the chances of audio gapping or crackling noise.
- **Active MIDI Inputs-** Displays all available MIDI input sources, i.e. keyboards, pad controls, MIDI knob/fader control surfaces, etc. Check boxes to enable one or more devices.