

BOSS DR-110 Dr. Rhythm

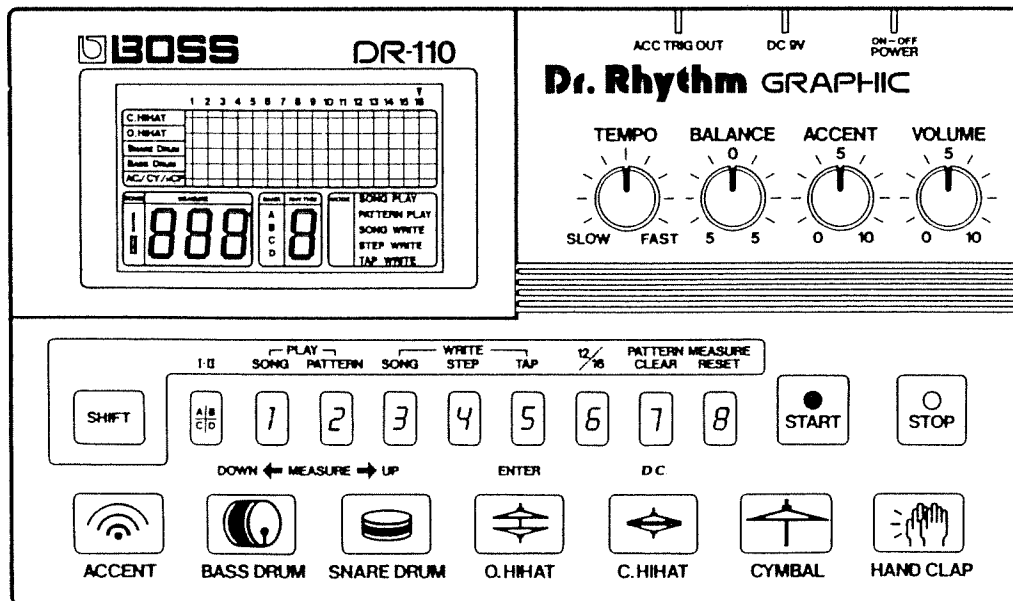

Owner's Manual

The Doctor Rhythm DR-110 is a fully programmable rhythm machine.

• Please read this owner's manual carefully.

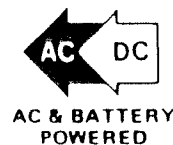

RADIO AND TELEVISION INTERFERENCE

Warning — This equipment has been verified to comply with the limits for a Class B computing device, pursuant to Subpart J, of Part 15, of FCC rules. Operation with non-certified or non-verified equipment is likely to result in interference to radio and TV reception.

The equipment described in this manual generates and uses radio-frequency energy. If it is not installed and used properly, that is, in strict accordance with our instructions, it may cause interference with radio and television reception.

This equipment has been tested and found to comply with the limits for a Class B computing device in accordance with the specifications in Subpart J, of Part 15, of FCC Rules. These rules are designed to provide reasonable protection against such a interference in a residential installation. However, there is no guarantee that the interference will not occur in a particular installation. If this equipment does cause interference to radio or television reception, which can be determined by turning the equipment on and off, the user is encouraged to try to correct the interference by the following measure:

- Disconnect other devices and their input/output cables one at a time. If the interference stops, it is caused by either the other device or its I/O cable.

These devices usually require Roland designated shielded I/O cables. For Roland devices, you can obtain the proper shielded cable from your dealer. For non Roland devices, contact the manufacturer or dealer for assistance.

If your equipment does cause interference to radio or television reception, you can try to correct the interference by using one or more of the following measures:

- Turn the TV or radio antenna until the interference stops.
- Move the equipment to one side or the other of the TV or radio.
- Move the equipment farther away from the TV or radio.
- Plug the equipment into an outlet that is on a different circuit than the TV or radio. (That is, make certain the equipment and the radio or television set are on circuits controlled by different circuit breakers or fuses.)
- Consider installing a rooftop television antenna with coaxial cable lead-in between the antenna and TV.

If necessary, you should consult your dealer or an experienced radio/television technician for additional suggestions. You may find helpful the following booklet prepared by the Federal Communications Commission:

“How to Identify and Resolve Radio-TV Interference Problems”

This booklet is available from the U.S. Government Printing Office, Washington, D.C., 20402, Stock No. 004-000-00345-4.

Features

- **The Doctor Rhythm DR-110 is a compact yet fully programmable rhythm machine.**
- The LCD (Liquid Crystal Display), showing current information in number, allows quick visual grasp of the data.
- Up to 16 Rhythm Patterns of your own can be written into memory. And as well, 16 different Rhythm Patterns are already preprogrammed ready to be in use.
- By combining the preset Rhythm Patterns and those you have written, the whole two pieces of music, each up to a maximum 128 measures, can be written into memory.
- 6 Sound Sources can be played not only with data you have written but also in real time by tapping the Instrument Keys.
- It is possible to write a triplet or triple time rhythm.
- An ACC Trig Out Jack is provided for controlling a synthesizer, etc.
- The DR-110 features Memory back up system, therefore, the data you have written can be retained even after switched off.
- The DR-110 can operate on both AC and Battery power. (AC Adaptor: BOSS PSA-120, 220, 240 optional).
- The P-BUS Jack enables set-up with the BOSS Headphone Amplifier HA-5, therefore, you can easily enjoy session play.

Bescheinigung des Herstellers / Importeurs
Hiermit wird bescheinigt, daß der/die/das BOSS Dr.Rhythm DR-110 <small>(Gerät, Typ, Bezeichnung)</small>
in Übereinstimmung mit den Bestimmungen der Amtsbl. Vfg 1046 / 1984 <small>(Amtsblattverfügung)</small>
funk entstort ist. Der Deutschen Bundespost wurde das Inverkehrbringen dieses Gerätes angezeigt und die Berechtigung zur Überprüfung der Serie auf Einhaltung der Bestimmungen eingeräumt.
Roland Corporation Osaka / Japan <small>Name des Herstellers/Importeurs</small>

Contents

Important Notes	5	SONG WRITE and PLAY	25
Power		Writing Song	
Locating		Playing Song	
Cleaning		• Correcting a mistake	
LCD		• Reference	
Power	5	Application	32
How to insert batteries		Using the P-BUS	
AC Adaptor		«What is P-BUS»	
Battery Replacement		• P-BUS as LINE IN	
Connection	8	• Connecting BOSS PLAY BUS HA-5	
Panel Description	9	ACC TRIG OUT	
Playing Rhythm Patterns	10	Preset Rhythm/Sample Rhythm	35
• Function of each key		Preset Rhythm	
• Selecting Rhythm Patterns		Sample Rhythm	
• Display Window		Original Memo	
• Reference		Specifications	54
Manual Play	13	Options	56
Writing Rhythm Patterns	14		
STEP WRITE Mode			
• Key point for writing			
• Writing triplet note and triple time			
• Reference			
TAP WRITE mode			
• Key point for writing			

Important Notes

Power

- The DR-110 can be powered by battery or AC Adaptor. If you are running it on battery power, replacement will be occasionaly necessary.

Location

- Operating the DR-110 near a neon or fluorescent lamp may cause noise interference. If so, change the angle or position of the DR-110.
- Avoid using the DR-110 in extreme heat

or humidity or where it may be affected by sunlight or dust.

Cleaning

- Use a soft cloth and clean only with mild detergent. Do not use solvents such as a paint thinner. Do not immerse in water.

LCD

- View the Display from the proper angle.
- Please be careful not to damage the window.

Power

How to insert batteries

- ① Make sure that the Power Switch is turned off.

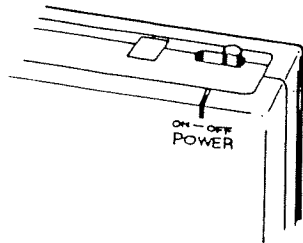

- ② Remove the cover from the battery housing by sliding it away.

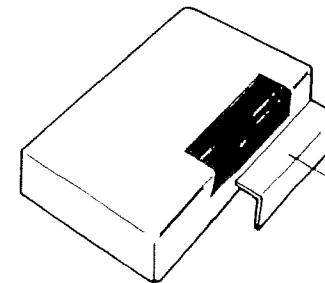

- ③ Place the supplied dry cell batteries in the battery housing in correct polarity, as marked inside housing.

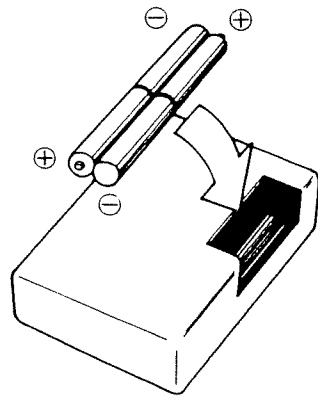

- ④ Replace the cover.

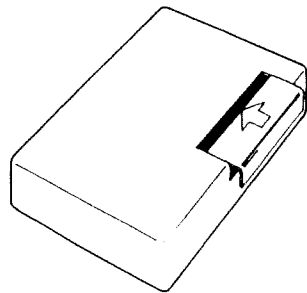

AC Adaptor

«Connections»

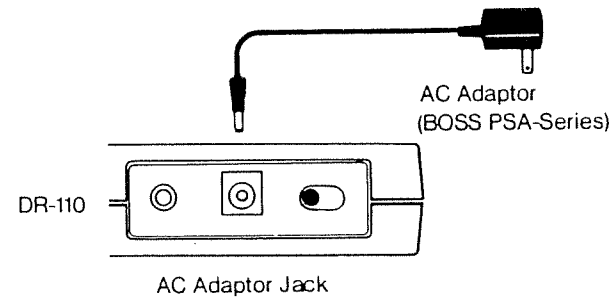

Please be sure to use an AC Adaptor that supplies 9 volts DC such as BOSS PSA 120, 220 or 240 depending on the voltage system in your country. (Using any other adaptor may cause trouble).

«Cautions»

- Please turn the DR-110 off, before connecting the AC Adaptor. Connecting the AC Adaptor with the DR-110 on may cause improper operation or even break down.

«To avoid accidental loss of your indispensable data»

- The DR-110 features a Memory back up system that retains the data you have written even when switched off, and this is fully supported by battery power. So, to avoid losing the data in memory, make sure to keep the batteries securely connected in the battery housing even while using the AC Adaptor.
- Please replace the whole set of the batteries with a new set once a year, whatever the battery consumption may be like.

«Battery replacement is required in the following cases»

- In about 120 hours, if ordinary dry cell type batteries are being used. (It varies depending on the type of the cells and how much the DR-110 has been used.)
- If the DR-110's LCD (Liquid Crystal Display) becomes dimmer or flares, or the sound or action of the unit becomes unstable.

«Battery Replacement»

- Please use 4 AA dry cells (UM-3).
- Please be sure to turn the DR-110 off and unplug the AC Adaptor if using one, before battery replacement.
- If you have made battery replacement within a few hours, data written in memory will be all protected finely.
- Please avoid leaving exhausted batteries connected, or trouble may be caused by battery leakage.
- When using battery power, please do not forget to turn off the Power Switch.

Connection

OUTPUT (P-BUS) Jack

- This is to connect to an amplifier (guitar, keyboard or audio).
- ☆ This jack also serves as LINE IN, as it is P-BUS standard. (Refer to P32)..

Headphone Jack

- Stereo headphones are to be connected to this jack.
- ☆ Appropriate impedance is 8 to 100Ω.
- ☆ The headphones should have a stereo mini plug. (If it has 1/4" standard phone plug, Mini to 1/4" adaptor plug will be necessary).
- ☆ Even if the headphones are connected to this jack, the OUTPUT jack still can send signals. So, if you need only headphones sound, do not use the OUTPUT jack, use the Headphone Jack.

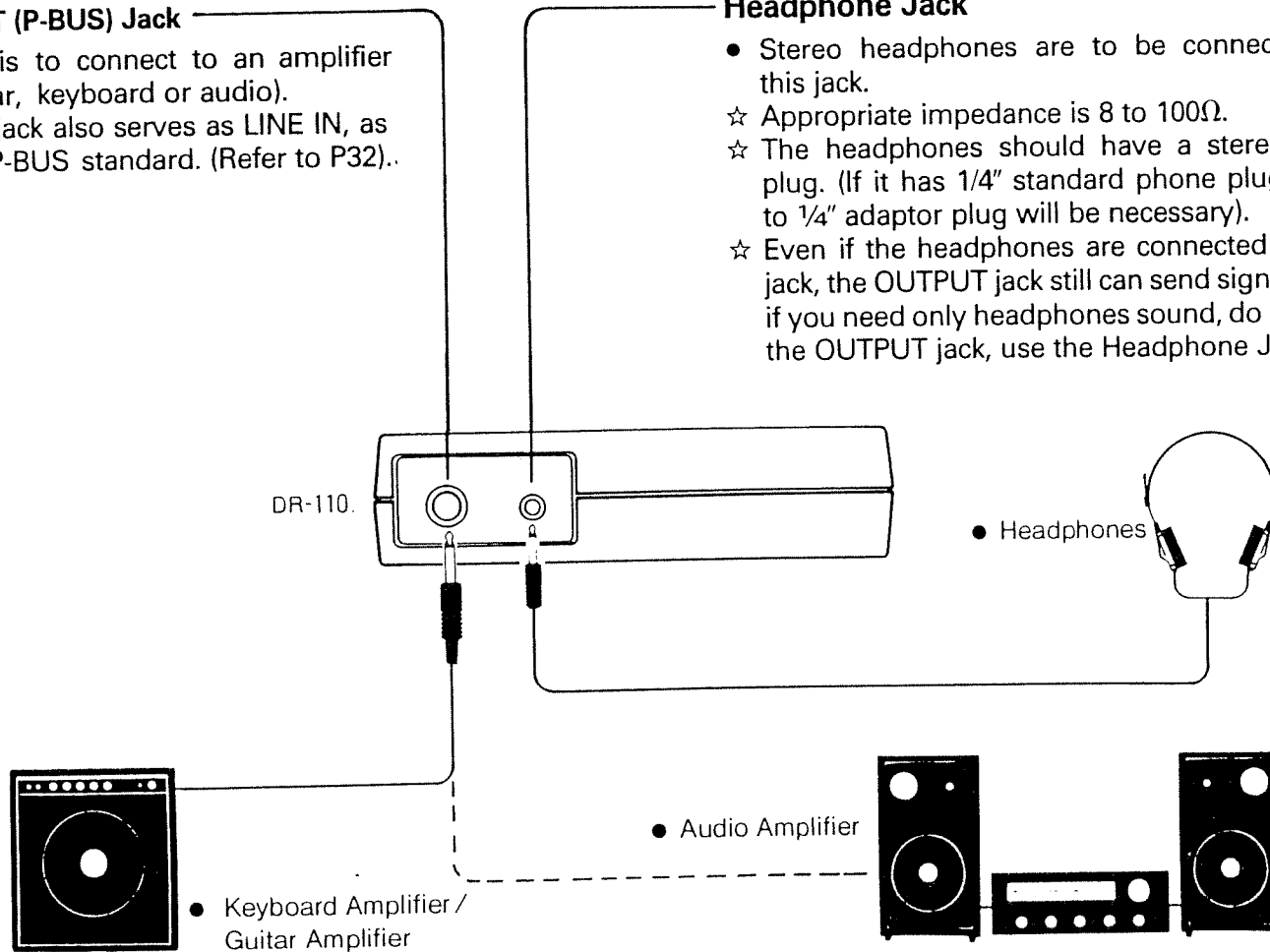

Panel Description

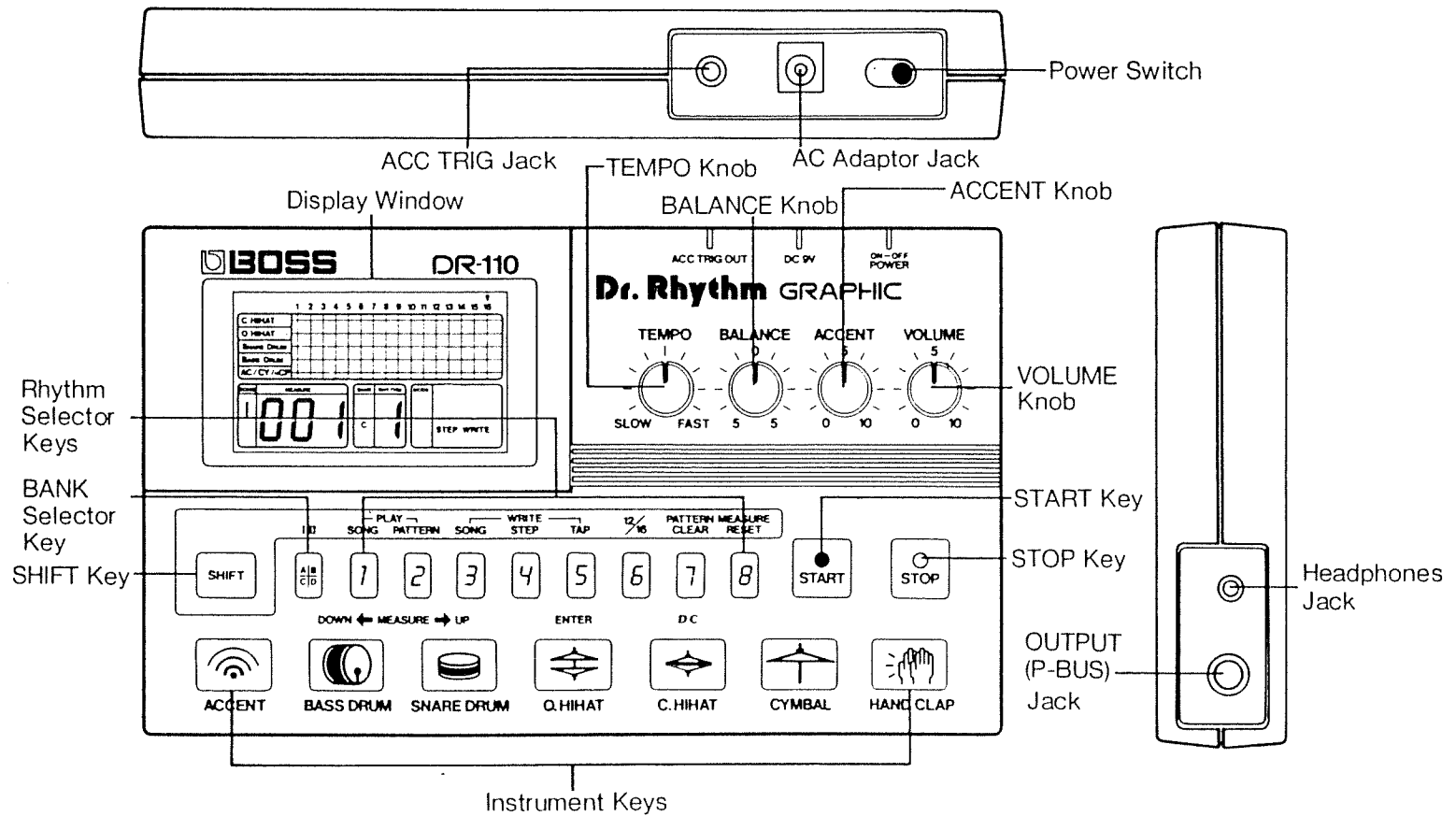

Playing Rhythm Patterns

16 different Rhythm Patterns are preprogrammed in the DR-110. The following are how to play them.

① Insert batteries, then set up an amplifier (or headphones), so that you can listen to Rhythm playing.

☆ How to insert batteries → See P.5.

☆ Connections → See P.8.

② Turn the DR-110 on.

☆ Number or dot representing the current data will be shown in the Display Window.

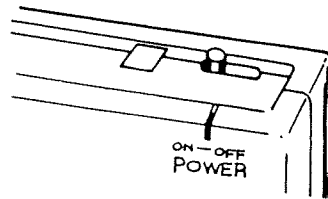

③ Set all the controls to the center positions.

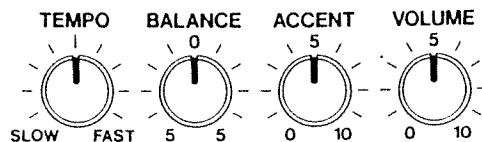

④ Press the START Key.

☆ Rhythm will start playing.

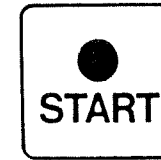

⑤ Change Rhythm Patterns by pressing a BANK Selector and Rhythm Selector Keys. (Refer to P.11)

☆ Please be sure to wait until one whole Rhythm Pattern is played up, before changing Rhythms.

⑥ Adjust each control to your liking. (Refer to P.12)

⑦ Pressing the STOP Key will immediately stop Rhythm playing.

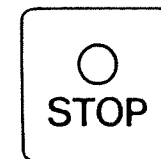

• **How to select a Rhythm Pattern**

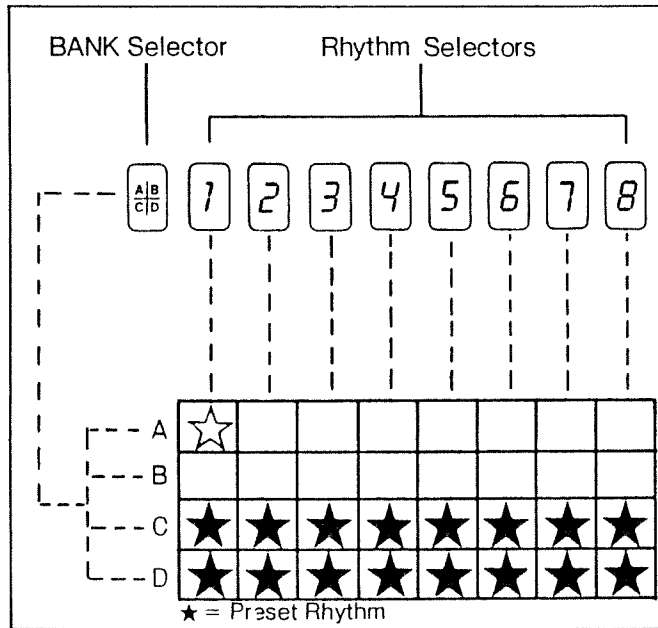

☆ For instance, if you press Bank A and Rhythm Selector Key 1, ☆ will be selected.

☆ There are 4 Banks A, B, C and D, each containing 8 Rhythm Patterns. Therefore, up to 32 different Rhythm Patterns are available.

☆ In Bank C and D, 16 Rhythm Patterns are preprogrammed and Bank A and B are left free for the user to write his own Rhythm Patterns (up to 16).

☆ Selecting either of the Bank A or B does not play Rhythm correctly.

☆ The currently selected Bank and Rhythm Pattern is shown in the Display.

☆ Each time the Bank Selector Key is pressed, the Bank changes →A→B→C→D→.

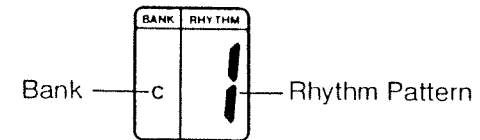

• Control Description

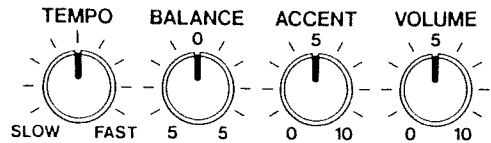

TEMPO Knob

This is to adjust the playing tempo of the Rhythm. Rotating this clockwise quickens the tempo.

BALANCE Knob

This is to adjust the proportion of the Drums and the Cymbal and Hihat volumes. Rotating this knob counter-clockwise increases the volume of the Drum sounds, and rotating it clockwise increases the volume of Hihat and Cymbal. Hand Clap sound does not change by the position of this knob.

ACCENT Knob

This is to control the intensity of the Accent. As you rotate this knob clockwise, the accent will become stronger. (If no accent is written, there will be no accent in playing Rhythm.)

VOLUME Knob

This is to adjust the volume. Rotating this knob clockwise will raise the volume.

• Display

Even while Rhythm is not playing, this dot blinks at the tempo of the rhythm.

Each sound source is shown here.

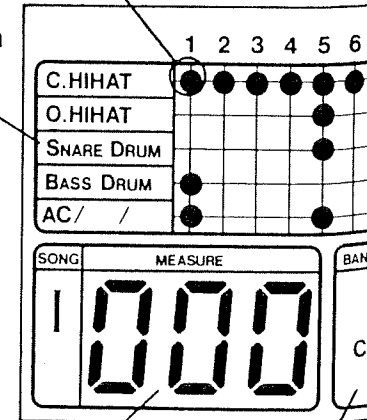

This part of the Display Window reacts while the DR-110 is in SONG WRITE or SONG PLAY Mode.

- See "SONG WRITE and PLAY" on P.25.

The selected Bank is shown here.

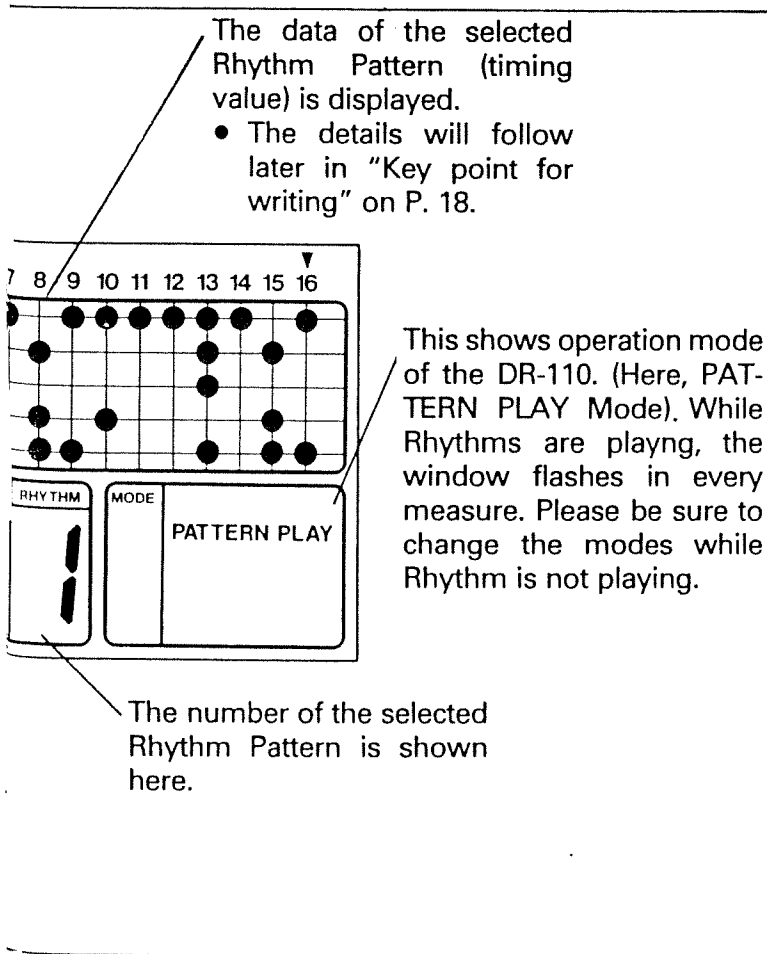

● Reference

The Preset Rhythm in Bank C and D will remain even if the batteries are removed. i.e. there is no way to erase them and write new patterns. See P.36. for the details of the Preset Rhythms.

Manual Play

By tapping the Instrument Key, you can play each sound source in such a tempo.

- This function is available even while Rhythm is playing.
- Accent can be added just by pressing the Accent Key.

Writing Rhythm Pattern

There are two major methods of writing a measure of Rhythm Pattern into the DR-110.

- **STEP WRITE**

Write Rhythms on the Display Screen.

- **STEP WRITE**

Tap the Instrument Keys and write a Rhythm Pattern as you play.

● **Example Score**

● **Rhythm Chart**

	1	2	3	4	5	6	7	8	9	10	11	12	13	14	15	16
C. HIHAT	●	●	●	●	●	●	●	●	●	●	●	●	●	●	●	▼
O. HIHAT																●
SNARE DRUM					●							●	●			
BASS DRUM	●				●		●				●		●		●	
ACCENT	●				●						●		●		●	
CYMBAL	●															
HAND CLAP					●								●			

- ① Make sure that Rhythm is not playing.
- ② While holding the SHIFT Key down, press the Rhythm Selector Key 4.
 - ☆ Now, the DR-110 is turned to the STEP WRITE mode.

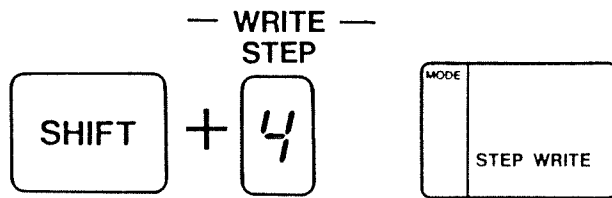

● **SHIFT Key**

This SHIFT Key is effectively used when one key serves double functions. i.e. pressing a key while the SHIFT Key is being held down will give the key the function as shown above it (in grey letters enclosed in a blue line).

- ③ Select the Rhythm Pattern by pressing the BANK Selector and the Rhythm Selector Keys.
 - ☆ For selecting A-1 pattern, select the Bank A and press the Rhythm Selector Key 1.

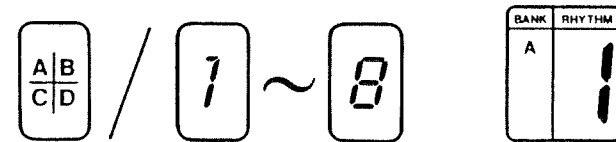

- ☆ The Display shows the number of the selected Rhythm Pattern.

- ④ Press the Rhythm Selector Key 7.
 - ☆ If there is already a Rhythm Pattern written, the above procedure erases it.

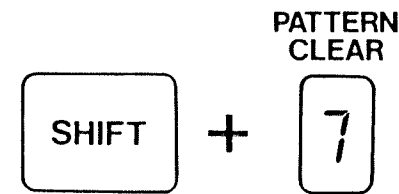

- ⑤ Select a sound source you like with the Instrument Key. e.g., if you want Bass Drum, simply press the Bass Drum Key.

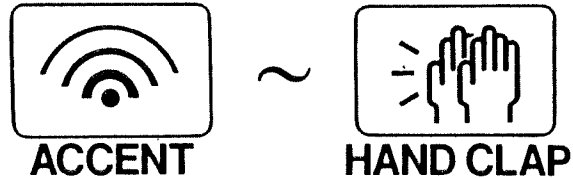

- ☆ The blinking dot moves onto the row of the selected sound source.
- ☆ Accent, Cymbal and Handclap occupy the same line in the Display Window, but only the one currently selected appears.

AC/ / If Accent is selected.
/CY/ If Cymbal is selected.
/ /HCP If Hand Clap is selected.

- ☆ HAND CLAP (HCP)
- CYMBAL (CY)
- C. HIHAT
- O. HIHAT
- SNARE DRUM
- BASS DRUM
- ACCENT (AC)

- ⑥ Write Rhythm Pattern according to the Rhythm Chart
- Dot → Press • Key (START Key)
- No mark → Press ○ Key (STOP Key)

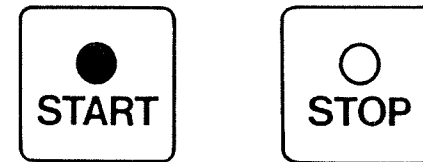

- ☆ If the • Key is pressed, a dot will be written, forwarding the blinking dot in the Display one step. If the ○ Key is pressed, the dot in the Display simply goes ahead one step without writing any.
- ☆ When the 16 steps have been written with one sound source, the blinking dot in the Display will go back to head (position 1).
- ⑦ Following the above procedures, write all sound sources and accents desired.

«If you make a mistake in writing»

Press the ○ Key a few times, and return the blinking dot to the head (1st position), then write correct a Rhythm Pattern.
Now, play the Rhythm.

- ⑧ While holding the SHIFT Key down, press the Rhythm Selector Key 2.
☆ Now the DR-110 is in the PATTERN PLAY mode.

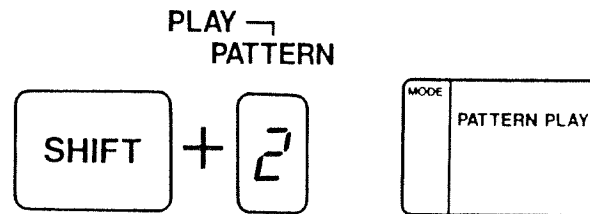

- ⑨ Press the START Key.



☆ The written Rhythm Pattern will play.

If you find any mistake, simply stop playing then write correct pattern by repeating operation ② → ⑤ → ⑥ .

- **Key point for writing**

The Rhythm Chart (or the Display) is divided into 16 steps of 16th notes. Each step can have "•" (sound) or no mark (no



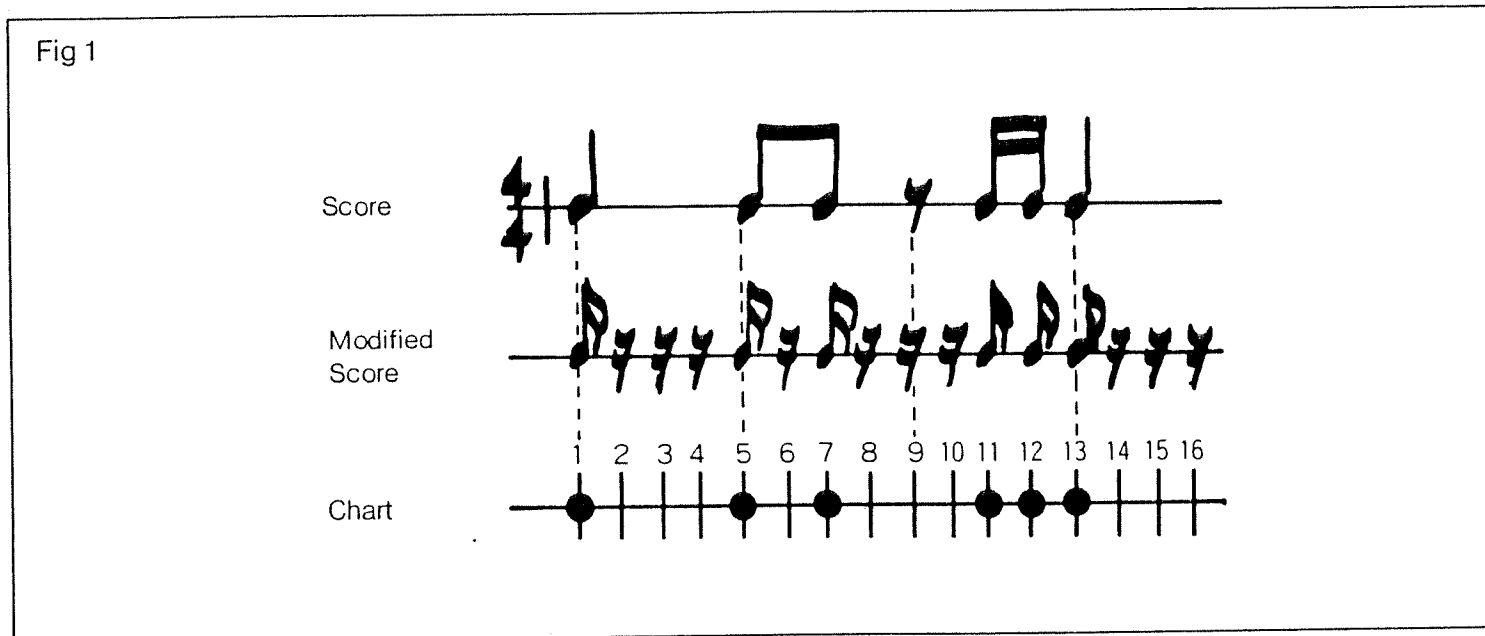











sound). All notes shown in a score should be replaced with ♪ and ♫, and • for ♪ and no mark for ♫ are to be set to complete a

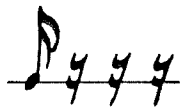

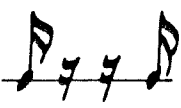
Rhythm Chart (Fig. 1). In the procedure of replacing the notes with ♪ and ♫, timing value is not involved, this is because percus-

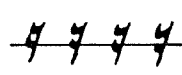
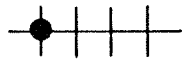
sive sounds are all very short. Please study the Rhythm Sample in Fig. 2.

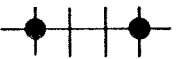
Fig 2 Rhythm Sample

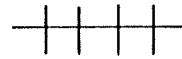
Score						
Modified Score						
Rhythm Chart						

● **Writing triplet and triple time**

To write triplet Rhythm such as Shuffle or Swing, or triple time, after completing up to procedure ④ on P.15, press the Rhythm Selector Key 6 while holding the SHIFT Key down. Here, the ▼ mark in the Display moves from 16 position to 12, showing that writing is now possible. Then continue to procedure ⑤.

«**Note**»

- If the blinking dot comes so far as to 12, it will go back to the beginning.
- When the Rhythm Patter is erased, ▼ mark will appear in the 16 position.
- The triple-time Rhythm of 12 steps has a different playing tempo from other 4/4 time Rhythms (triplet is slightly slower), therefore you need to be careful when playing different Rhythms continuously. (Triplet Rhythm have matching tempo.)

[Display]

Writing triple time

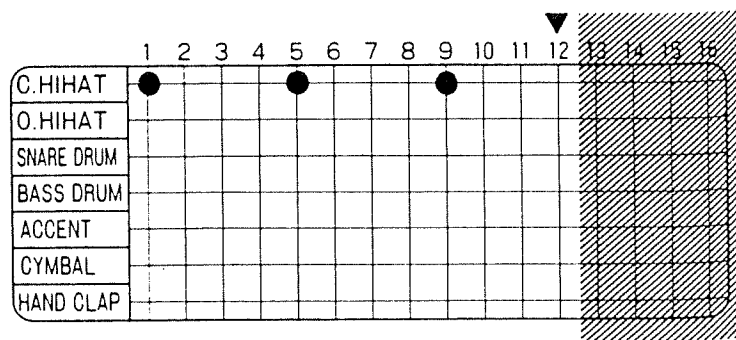

This part is not to be used.

"Note"

Each "●" shows the head position of Beat.

- In this case, one step is ♪.

- If you are to return ▼ mark to the 16 position after setting it to 12 once, repeat the same procedures as already described in "Writing triplet and triple time" on P.20.

Writing Triplet

	1	2	3	4	5	6	7	8	9	10	11	12	13	14	15	16
C. HIHAT	●			●			●			●						
O. HIHAT																
SNARE DRUM																
BASS DRUM																
ACCENT																
CYMBAL																
HAND CLAP																

▼

This part is not to be used.

"Note"

- Each "●" shows the head position of Beat within a measure.
- In this case, one step is not $\frac{1}{4}$, but $\frac{1}{3}$ that is the $\frac{1}{3}$ of $\frac{1}{4}$ note.

• Example

Scale

Modified Score

Chart

- **Reference**

- ① The Display's indication; AC, CY, HCP changes only during the STEP WRITE mode. Therefore, if you want to see the Rhythm Chart of a particular Sound Source during PLAY mode, simply press the STEP WRITE Button then the relevant Instrument Key.
- ② If you write Open Hihat on Closed Hihat (in the same timing), Closed Hihat with Accent will be obtained.
- ③ To make break (rests), just erase the Rhythm Pattern.
- ④ Usually, one step is to be ♩ (or ♪) in the chart (or Display), but it can be ♩ or ♪ as you like.

[Example1: 1 Step = ♩]

The notation shows four staves. The top staff is labeled 'C. HIHAT' and 'O. HIHAT' and contains a continuous sequence of eighth notes with accents. The second staff is labeled 'SNARE DRUM' and contains a pattern of eighth notes with accents. The third staff is labeled 'BASS DRUM' and contains a pattern of eighth notes with accents.

- There can be two measures written within one Rhythm Pattern, but shorter rhythm such as ♩ cannot be written.

[Example 2: 1 Step = ♩]

Refer to Sample Rhythm on P.46.

«Note»

In either case above, the tempo of the Rhythm will be different from the one written in a usual way (1 Step = ♩).

TAP WRITE

Tap the Instrument Keys along with metronome and write Rhythm Pattern. The DR-110 does not include metronome, so write Hihat as a metronome.

- ① Observing the STEP WRITE procedures 1 to 7 on P.14 write the following metronome rhythm.

● Rhythm for metronome

- ② While holding the SHIFT Key down, press the Rhythm Selector Key 5.

☆ The DR-110 is now in the TAP WRITE mode.

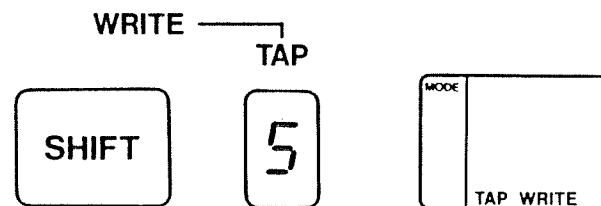

- ③ Press the START Key.

☆ The metronome rhythm you have written will play.



- ④ Press any Instrument Key you like along with the metronome.

☆ The Rhythm in such intervals as the key tapping will be written.

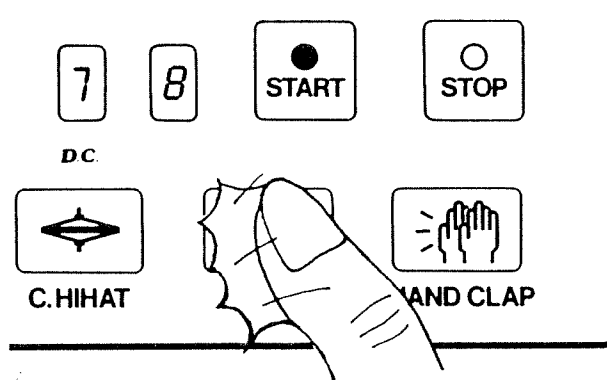

- You may tap as many Instrument Keys as you like at a time.
- The lowest line in the Display shows "AC", but Cymbal and Hand Clap can also be written.

«If you make a mistake»

If you wish to correct the mistake, press the Instrument Key that is relevant to the mistake for a few seconds, while holding the Rhythm Selector Button 7. All the dots in the line of that instrument will go out, and now writing a new Rhythm is possible.

• Key Point for TAP WRITE

- ① Any sound source can be used as a metronome. (Here, used are Closed Hihat, and Open Hihat to make it easy to see head of the first step).
- ② In the example, metronome interval is set to ♩ , but can be set what you like, such as ♩ .
- ③ For instance, if you are using Closed Hihat as a metronome, clear the Hihat after writing Bass Drum and Snare Drum, so that writing Hihat will be easier.

SONG WRITE and PLAY

Using the Rhythm Patterns you have written and the Preset Rhythms, you can write entire Rhythm Patterns of a piece of music. Two pieces each up to a maximum of 128 measures can be written.

Writing a Song

- ① Make sure that Rhythm is not playing.
- ② While holding the SHIFT Key down, press the Rhythm Selector Key 3.
☆ Now, the DR-110 is in the SONG WRITE mode.

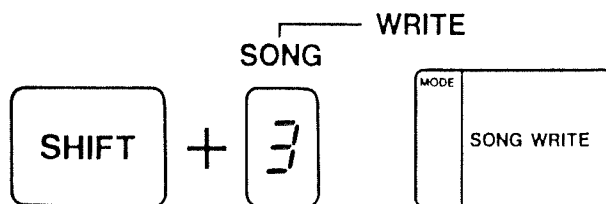

- ③ Select either Song number I or II.
 - While holding the SHIFT Key down, press the BANK Selector Button, and the number changes I and II alternately each time it is pressed.

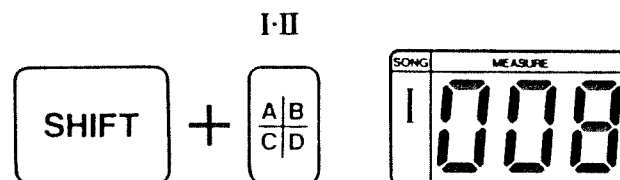

- ④ While holding the SHIFT Key down, press the Rhythm Selector Key 8.
☆ Now the first measure of the Song is ready to start to play.

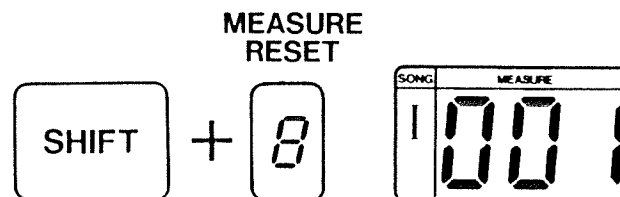

- ⑤ Press the START Key.
☆ Rhythm will start playing.



⑥ Select the Rhythm Pattern you wish to write into the first measure.

☆ The selected Rhythm Pattern is now shown in the Display and plays.

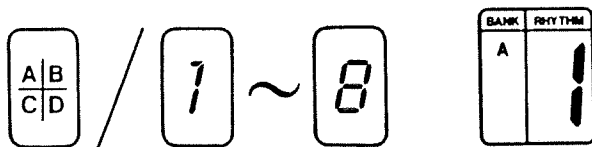

⑦ Press the ENTER Key (O.HIHAT).

☆ Now the selected Rhythm Pattern is written into the first measure, and it will move to the second measure.

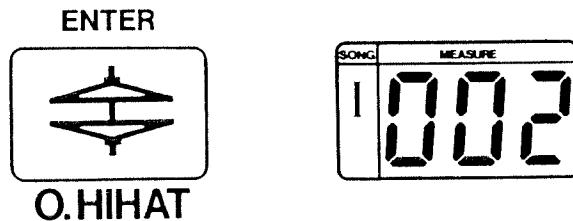

⑧ Select the Rhythm Pattern to be written into the second measure.

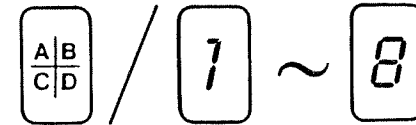

⑨ Press the ENTRY Key.

☆ The selected Rhythm Pattern is written into the second measure and it moves to the third measure.

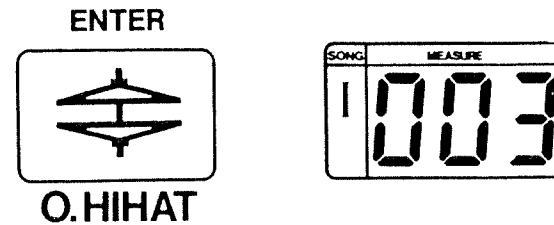

- Likewise, keep writing up to the measure just before the final one.
- If you are to write the same Rhythm Pattern as the one before, just pressing the ENTER Key will be sufficient.

⑩ Selected Rhythm Pattern for the last measure.

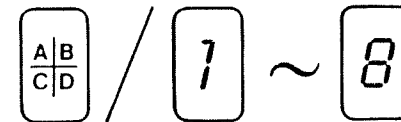

- ⑪ Press the D.C. Key (C. HIHAT)
- ☆ Now D.C. (da capo) is set to the final measure.

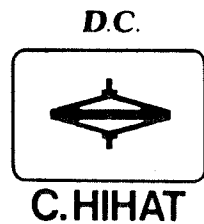

- ⑫ Press the ENTER Key.
- ☆ The selected Rhythm Pattern is now written into the final measure, and it moves to the next measure.

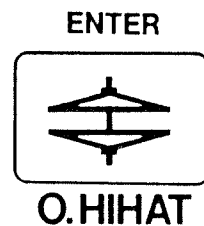

- ⑬ Press the STOP Key.

Now try playing the Rhythm.

Playing Song

- ① While holding the SHIFT Key down, press the Rhythm Selector Key 1.
- ☆ Now the DR-110 is turned to the SONG PLAY mode.

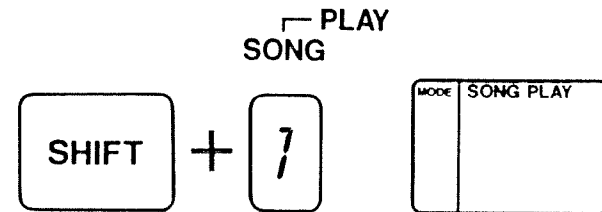

- ② Select either Song number I or II.
- ☆ Press the BANK Selector Key while holding the SHIFT Key down, and the Song number will alternately changes I and II.

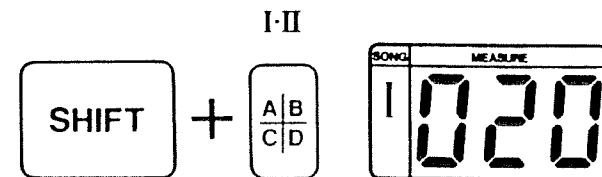

- ③ While holding the SHIFT Key down, press the Rhythm Selector Key 8.
- ☆ Now the first measure of the Song is ready to play.

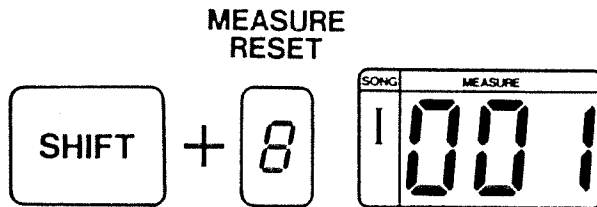

- ④ Press the START Key.
 ☆ Now the Rhythm Patterns you have written play from the first measure. The Display shows the currently playing measure.

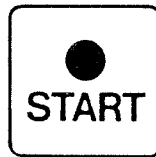

- After the final measure (where D.C. is set) is played, the first measure will start playing again (Loop play).
- ⑤ Pressing the STOP Key will immediately stop playing.

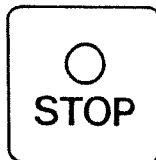

- If you have made a mistake in writing

Correct it as follows.

«If Rhythm Patterns are wrongly written»

- ① Set the DR-110 to the SONG WRITE mode.

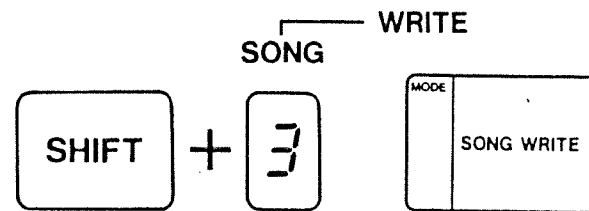

- ② By using the MEASURE UP and DOWN Keys, go to the relevant measure.
- The MEASURE UP and DOWN Keys work only in the SONG WRITE Mode.

DOWN ← MEASURE → UP



BASS DRUM

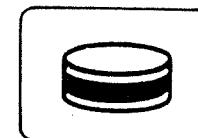

SNARE DRUM

«How to use the MEASURE UP and DOWN Keys»

- Pressing the UP Key will advance 1 measure, and DOWN Key will back 1 measure up. (The Display changes accordingly.)
- You can forward measures continuously by pressing both the UP and DOWN Keys together, but you cannot back up measures.
- If all 128 measures are played up, it automatically stops playing.

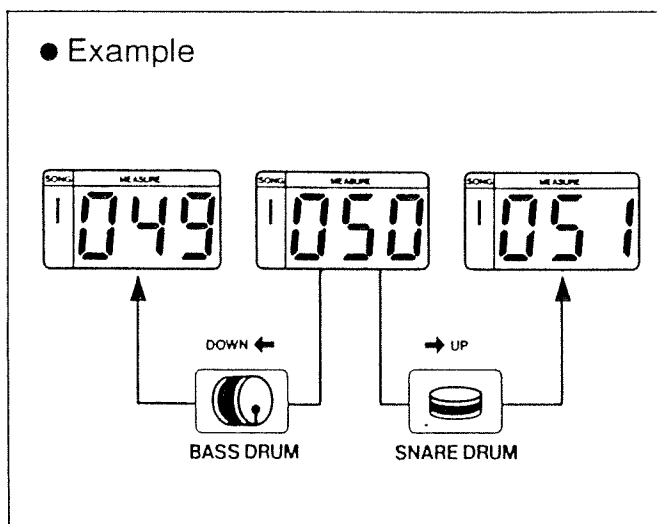

- ③ Press the START Key and start playing.



- ④ This time select the correct Rhythm Pattern.

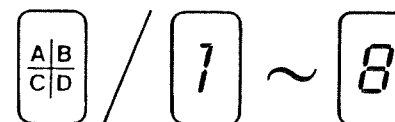

- ⑤ Press the ENTER Key.

☆ Now the new correct pattern is written.



- ⑥ Press the STOP Key.

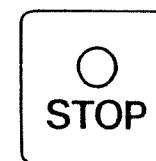

«If you have written D.C. in a wrong position, or too many or few measures»

Set another D.C. in this case.

- ① Set the DR-110 to the SONG WRITE mode.

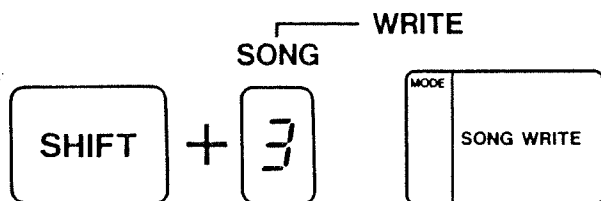

- ② Go to the measure where you wish to write D.C.

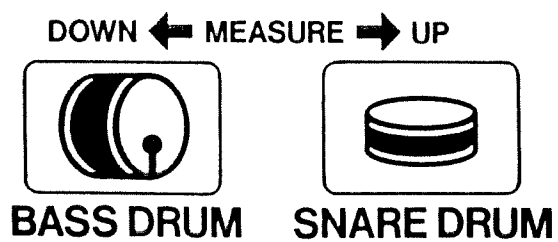

- ③ Start Rhythm play by pressing the START Key.



- ④ Press the D.C. Key.

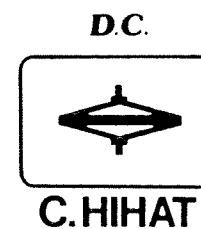

- ⑤ Press the STOP Key.

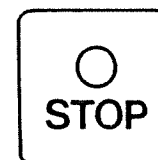

- **Reference**

- ① If you mistakenly press the D.C. Key during writing, just carry on writing and press the D.C. Key to the final measure. (Da capo is written to the later measure.)
- ② If you have written the triplet time then 4/4 time continuingly, their tempoes will be different.
- ③ You can start playing from any measure you like. Simply set the DR-110 to the SONG WRITE mode, and call any measure you like by using the MEASURE UP and the DOWN Keys.
- ④ Even during song playing, it is possible to add other sound sources by tapping the Instrument Keys.
- ⑤ For instance, if you wish to move from the measure 100 to 20, it is quicker to reset to the first measure (by pressing the Rhythm Selector button 8 while holding the SHIFT Key down), and forward measures by pressing the UP and DOWN Keys together.
- ⑥ If you think it difficult to stop playing the moment the final measure is played, it may be a good idea to write a few measure rests after the final measure.

Application

Using PLAY BUS

- Using the P-BUS as LINE IN

The Output (P-BUS) can be used as Line In. For instance, by feeding keyboard signal, you can monitor the Rhythm and keyboard sounds.

«P-BUS»

☆ This is an amazingly useful system that allows signal output and input only with single Bus Line (a guitar cord). By setting up the Roland Headphone Amplifier HA-5, you can easily enjoy session play.

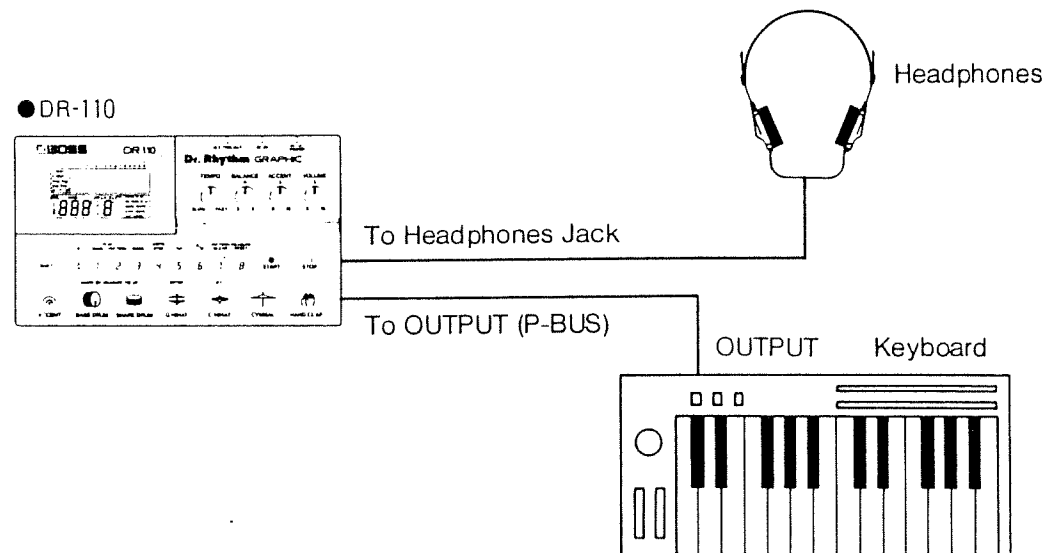

● **Setting up the BOSS PLAY BUS HA-5**

☆ Please see the owner's manual of the HA-5 for the details.

«Example setting up»

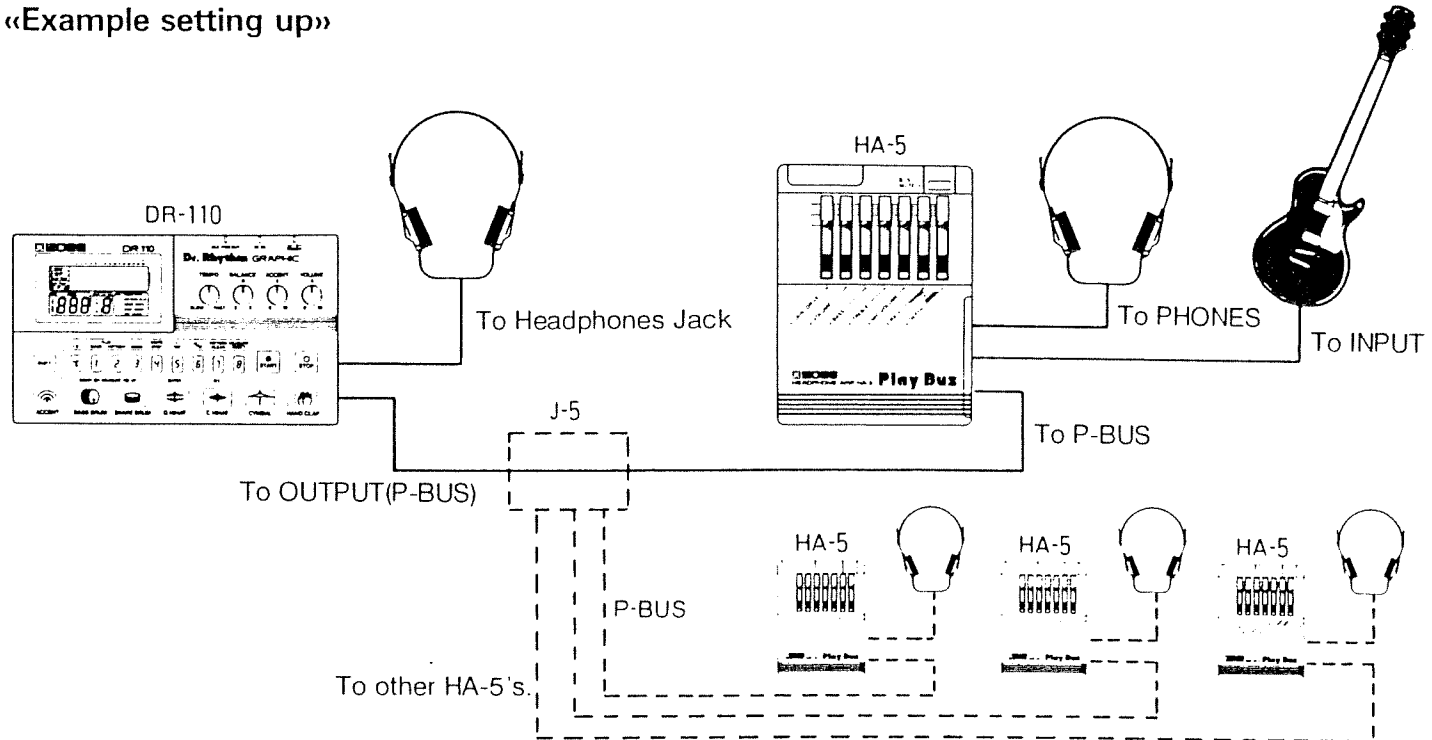

● ACC TRIG OUT Jack

☆ Trigger Pulse (+6V, 10ms) will be sent at such intervals as Accents have been written.

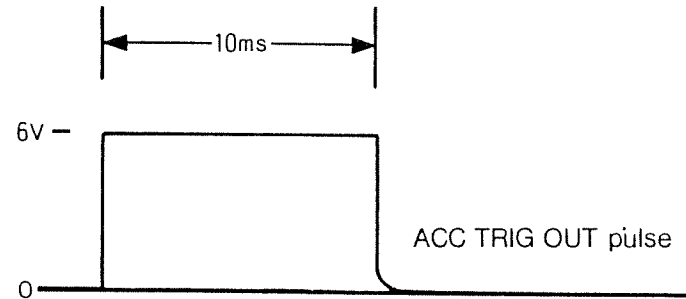
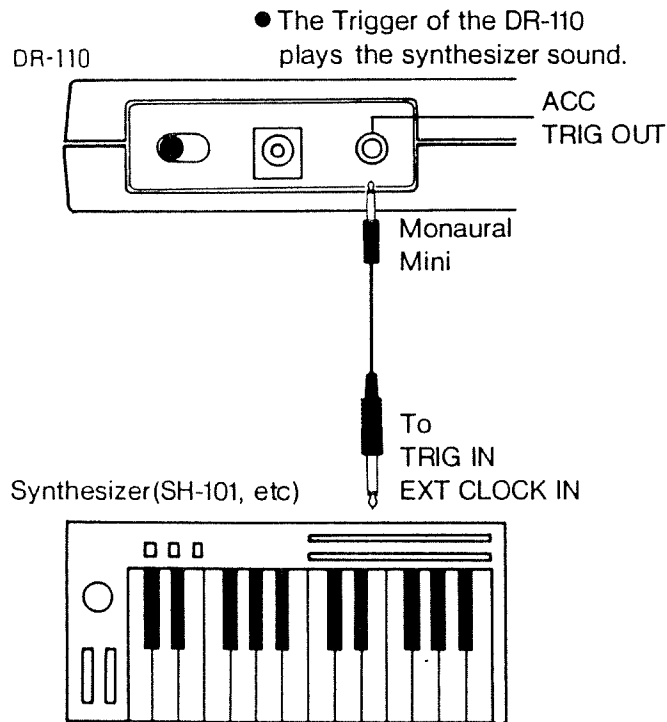

☆ By connecting the EXT (ARPEGGIO) CLOCK IN Jack of a synthesizer to this jack, it is made possible to control the built-in Arpeggio or Sequencer by an external Synthesizer, or to start or stop the Sequencer, and many more are possible.

**Preset Rhythm
&
Sample Rhythm**

Preset Rhythms

C-1

C.HIHAT
O.HIHAT

SNARE
DRUM

BASS
DRUM

CYMBAL

HAND
CLAP

C-2

C.HIHAT
O.HIHAT

SNARE
DRUM

BASS
DRUM

CYMBAL

HAND
CLAP

※ Hihat Score..... ♩ = Closed Hihat

⌵ = Open Hihat

♩ = Closed & Open Hihat

C-3

C.HIHAT
O.HIHAT

SNARE
DRUM

BASS
DRUM

CYMBAL

HAND
CLAP

C-4

C.HIHAT
O.HIHAT

SNARE
DRUM

BASS
DRUM

CYMBAL

HAND
CLAP

C-5

C.HIHAT
O.HIHAT

SNARE
DRUM

BASS
DRUM

CYMBAL

HAND
CLAP

C-7

C.HIHAT
O.HIHAT

SNARE
DRUM

BASS
DRUM

CYMBAL

HAND
CLAP

C-6

C.HIHAT
O.HIHAT

SNARE
DRUM

BASS
DRUM

CYMBAL

HAND
CLAP

C-8

C.HIHAT
O.HIHAT

SNARE
DRUM

BASS
DRUM

CYMBAL

HAND
CLAP

D-1

C. HIHAT
O. HIHAT

SNARE
DRUM

BASS
DRUM

CYMBAL

HAND
CLAP

D-3

C. HIHAT
O. HIHAT

SNARE
DRUM

BASS
DRUM

CYMBAL

HAND
CLAP

D-2

C. HIHAT
O. HIHAT

SNARE
DRUM

BASS
DRUM

CYMBAL

HAND
CLAP

D-4

C. HIHAT
O. HIHAT

SNARE
DRUM

BASS
DRUM

CYMBAL

HAND
CLAP

D-5

C. HIHAT
O. HIHAT

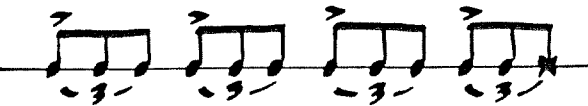

SNARE
DRUM



BASS
DRUM

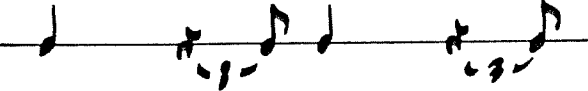

CYMBAL

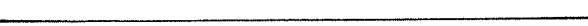

HAND
CLAP



D-6

C. HIHAT
O. HIHAT



SNARE
DRUM

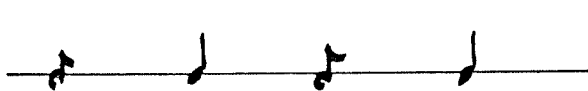

BASS
DRUM

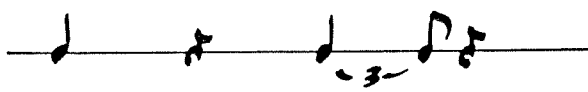

CYMBAL



HAND
CLAP



D-7

C. HIHAT
O. HIHAT

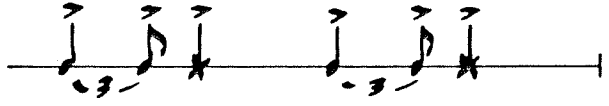

SNARE
DRUM



BASS
DRUM



CYMBAL

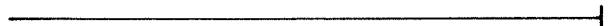

HAND
CLAP



D-8

C. HIHAT
O. HIHAT



SNARE
DRUM

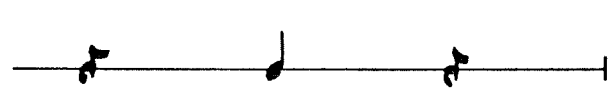

BASS
DRUM

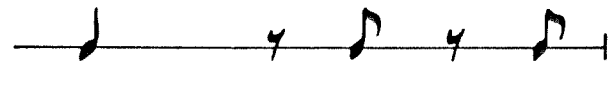

CYMBAL



HAND
CLAP



Sample Rhythm

ROCK I (8 Beat)

	1	2	3	4	5	6	7	8	9	10	11	12	13	14	15	16
C. HIHAT																
O. HIHAT																
SNARE DRUM					●								●			
BASS DRUM	●								●		●					
ACCENT	●				●				●		●		●			
CYMBAL	●		●		●		●		●		●		●		●	
HAND CLAP																

C. HIHAT
O. HIHAT

SNARE DRUM

BASS DRUM

CYMBAL

HAND CLAP

- ☆ = Rhythm Pattern for the beginning of a song.
- = Rhythm Pattern for Fill In.
- = Write as you prefer.

ROCK II (Boogie-woogie)

	1	2	3	4	5	6	7	8	9	10	11	12	13	14	15	16
C. HIHAT	●						●									
O. HIHAT				■							■					
SNARE DRUM				●						●			●			
BASS DRUM	●						●		●							
ACCENT	●			●			●		●			●				
CYMBAL	●			●			●			●						
HAND CLAP																

C. HIHAT
O. HIHAT

SNARE DRUM

BASS DRUM

CYMBAL

HAND CLAP

ROCK III (16 Beat)

	1	2	3	4	5	6	7	8	9	10	11	12	13	14	15	16
C. HIHAT	●	●	●	●	●	●	●	●	●	●	●	●	●	●	●	●
O. HIHAT	●				●				●				●			
SNARE DRUM					●								○	○		
BASS DRUM	●			●			●			●			●			
ACCENT	●			●			●			●			●			○
CYMBAL	■		■	■	■		■	■	■		■	■	■		■	■
HAND CLAP																

C. HIHAT 

O. HIHAT 

SNARE DRUM 

BASS DRUM 

CYMBAL 

HAND CLAP 

FILL IN I

	1	2	3	4	5	6	7	8	9	10	11	12	13	14	15	16
C. HIHAT																
O. HIHAT																
SNARE DRUM	●			●	●			●	●							
BASS DRUM		●				●				●		●		●		●
ACCENT	●	●			●	●			●	●		●		●		●
CYMBAL																
HAND CLAP																

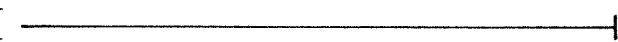
C. HIHAT 

O. HIHAT 

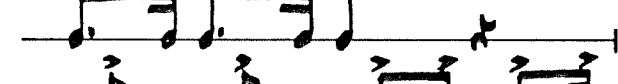
SNARE DRUM 

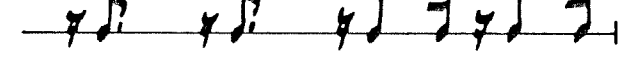
BASS DRUM 

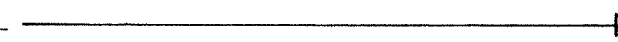
CYMBAL 

HAND CLAP 

ELECTRONIC POP I

	1	2	3	4	5	6	7	8	9	10	11	12	13	14	15	16
C. HIHAT	●		●	●	●		●	●	●		●	●	●		●	●
O. HIHAT																
SNARE DRUM					●							●		○	○	
BASS DRUM	●				●				●				●			
ACCENT	●			●				●				●			○	○
CYMBAL	☆															
HAND CLAP				■								■				

C. HIHAT
O. HIHAT

SNARE DRUM

BASS DRUM

CYMBAL

HAND CLAP

ELECTRONIC POP II

	1	2	3	4	5	6	7	8	9	10	11	12	13	14	15	16
C. HIHAT	●		●	●	●		●								●	●
O. HIHAT								●		●			●			
SNARE DRUM					●								●			
BASS DRUM	●			●				●					●			
ACCENT	●											●			●	
CYMBAL	☆								●				●			
HAND CLAP																●

C. HIHAT
O. HIHAT

SNARE DRUM

BASS DRUM

CYMBAL

HAND CLAP

FILL IN II

	1	2	3	4	5	6	7	8	9	10	11	12	13	14	15	16
C. HIHAT																
O. HIHAT																
SNARE DRUM		●	●	●		●	●	●		●	●	●	●	●	●	
BASS DRUM	●				●				●			●		●		
ACCENT	●			●	●			●	●			●	●	●	●	
CYMBAL	●											●				
HAND CLAP																

C. HIHAT _____

O. HIHAT _____

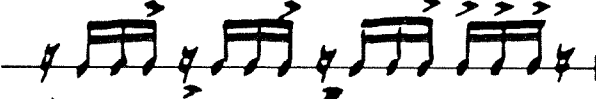
SNARE DRUM 

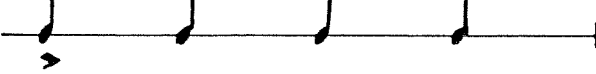
BASS DRUM 

CYMBAL 

HAND CLAP _____

DISCO

	1	2	3	4	5	6	7	8	9	10	11	12	13	14	15	16
C. HIHAT	●				●				●				●			
O. HIHAT			●				●				●				●	
SNARE DRUM					●							●	●	○	○	
BASS DRUM	●				●				●			●		●		
ACCENT	●				●				●			●		○	○	
CYMBAL	☆															
HAND CLAP					■								■			

C. HIHAT 

O. HIHAT 

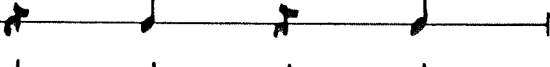
SNARE DRUM 

BASS DRUM 

CYMBAL 

HAND CLAP 

★ This is a typical Disco pattern. With the Snare Drum (J), it will become Fill in.

LATIN I (Bossanova)

	1	2	3	4	5	6	7	8	9	10	11	12	13	14	15	16
C. HIHAT	●	●	●	●	●	●	●	●	●	●	●	●	●	●	●	●
O. HIHAT	●			●			●				●			●		
SNARE DRUM																
BASS DRUM	●			●	●			●	●			●	●			●
ACCENT					●							●				
CYMBAL																
HAND CLAP																

C. HIHAT

O. HIHAT

SNARE DRUM

BASS DRUM

CYMBAL

HAND CLAP

LATIN II (Samba)

	1	2	3	4	5	6	7	8	9	10	11	12	13	14	15	16
C. HIHAT	●	●	●	●	●	●	●	●	●	●	●	●	●	●	●	●
O. HIHAT				●					●				●			●
SNARE DRUM	●			●	●					●			●	●		
BASS DRUM	●			●	●				●	●			●	●		●
ACCENT	●			●	●				●	●			●	●		
CYMBAL																
HAND CLAP	■		■		■					■			■			

C. HIHAT

O. HIHAT

SNARE DRUM

BASS DRUM

CYMBAL

HAND CLAP

LATIN III (Tango)

	1	2	3	4	5	6	7	8	9	10	11	12	13	14	15	16
C.HIHAT	●				●				●				●			
O.HIHAT															●	
SNARE DRUM	●				●				●				●		●	
BASS DRUM	●				●				●				●		●	
ACCENT	●				●				●				●		●	
CYMBAL																
HAND CLAP																

C.HIHAT

O.HIHAT

SNARE DRUM

BASS DRUM

CYMBAL

HAND CLAP

LATIN IV (Mambo)

	1	2	3	4	5	6	7	8	9	10	11	12	13	14	15	16
C.HIHAT	●			●	●		●		●		●		●			
O.HIHAT			●				●						●		●	
SNARE DRUM																
BASS DRUM	●						●						●			
ACCENT																
CYMBAL																
HAND CLAP																

C.HIHAT

O.HIHAT

SNARE DRUM

BASS DRUM

CYMBAL

HAND CLAP

ROCK (32 Beat (A))

	1	2	3	4	5	6	7	8	9	10	11	12	13	14	15	16
C. HIHAT	●	●	●	●	●		●		●		●		●			
O. HIHAT															●	
SNARE DRUM								●								
BASS DRUM	●														●	
ACCENT	●							●								
CYMBAL	☆															
HAND CLAP																

C. HIHAT

O. HIHAT

SNARE DRUM

BASS DRUM

CYMBAL

HAND CLAP

Detailed description: This block contains musical notation for the drum parts of Rock (32 Beat A). The C. HIHAT part consists of four groups of eighth notes: a triplet of eighth notes on beat 1, eighth notes on beats 2-3, eighth notes on beats 4-5, and eighth notes on beats 11-12. The O. HIHAT part has a single eighth note on beat 15. The SNARE DRUM part has eighth notes on beats 1, 3, 5, 7, 9, 11, 13, and 15. The BASS DRUM part has eighth notes on beats 1, 3, 5, 7, 9, 11, 13, and 15. The CYMBAL part has a cymbal flourish on beat 1, marked with a star. The HAND CLAP part is empty.

★ This is a high technique used in Fusion music.

ROCK (32 Beat (B))

	1	2	3	4	5	6	7	8	9	10	11	12	13	14	15	16
C. HIHAT	●	●	●	●					●							
O. HIHAT					●								●			
SNARE DRUM			●						●				●	●	●	●
BASS DRUM							●		●				●			
ACCENT	●								●				●			
CYMBAL																
HAND CLAP																

C. HIHAT

O. HIHAT

SNARE DRUM

BASS DRUM

CYMBAL

HAND CLAP

Detailed description: This block contains musical notation for the drum parts of Rock (32 Beat B). The C. HIHAT part consists of four groups of eighth notes: a triplet of eighth notes on beat 1, eighth notes on beats 2-3, eighth notes on beats 4-5, and eighth notes on beats 11-12. The O. HIHAT part has eighth notes on beats 5, 13, and 15. The SNARE DRUM part has eighth notes on beats 3, 5, 7, 9, 11, 13, 14, 15, and 16. The BASS DRUM part has eighth notes on beats 7, 9, 11, 13, and 15. The CYMBAL part is empty. The HAND CLAP part is empty.

★ Write two patterns separately, then with the Song function put them together.

SLOW ROCK (TRIPLET)

	1	2	3	4	5	6	7	8	9	10	11	12	13	14	15	16
C. HIHAT	●	●	●	●	●	●	●	●	●	●	●	●				
O. HIHAT				●						●						
SNARE DRUM				●						●						
BASS DRUM	●					●	●					●				
ACCENT																
CYMBAL	☆															
HAND CLAP																

C. HIHAT

O. HIHAT

SNARE DRUM

BASS DRUM

CYMBAL

HAND CLAP

SHAFFLE ROCK

	1	2	3	4	5	6	7	8	9	10	11	12	13	14	15	16
C. HIHAT	●		●				●		●							
O. HIHAT				●						●						
SNARE DRUM							●									
BASS DRUM	●					●						●				
ACCENT	●						●					●				
CYMBAL	☆															
HAND CLAP																

C. HIHAT

O. HIHAT

SNARE DRUM

BASS DRUM

CYMBAL

HAND CLAP

4 BEAT

	1	2	3	4	5	6	7	8	9	10	11	12	13	14	15	16
C. HIHAT				●		●				●		●				
O. HIHAT	●						●									
SNARE DRUM												■				
BASS DRUM	■															
ACCENT	●			●			●			●						
CYMBAL	■			■			■			■						
HAND CLAP				■						■						

C. HIHAT

O. HIHAT

SNARE DRUM

BASS DRUM

CYMBAL

HAND CLAP

★ Put Snare Drum and Bass Drum, if you like.

REGGAE

	1	2	3	4	5	6	7	8	9	10	11	12	13	14	15	16
C. HIHAT	■			●		●	●			●		●				
O. HIHAT																
SNARE DRUM							●									
BASS DRUM							●									
ACCENT				●			●			●						
CYMBAL																
HAND CLAP																

C. HIHAT

O. HIHAT

SNARE DRUM

BASS DRUM

CYMBAL

HAND CLAP

★ Put Cymbal, if you think necessary.

MARCH

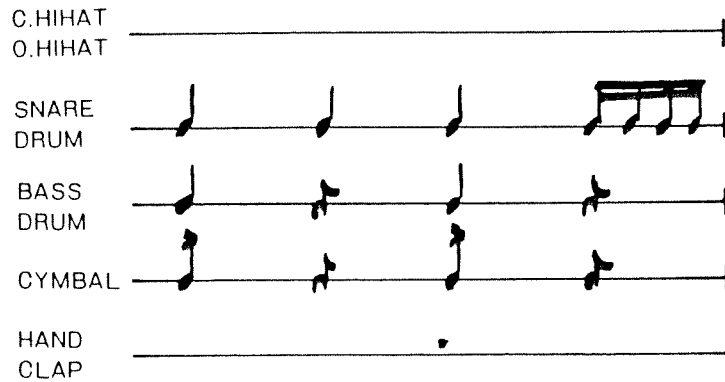
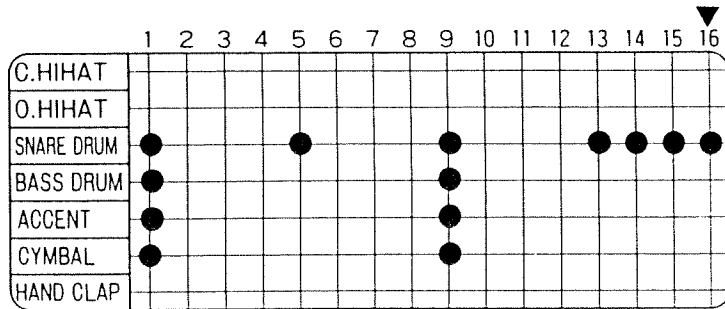

WALZ

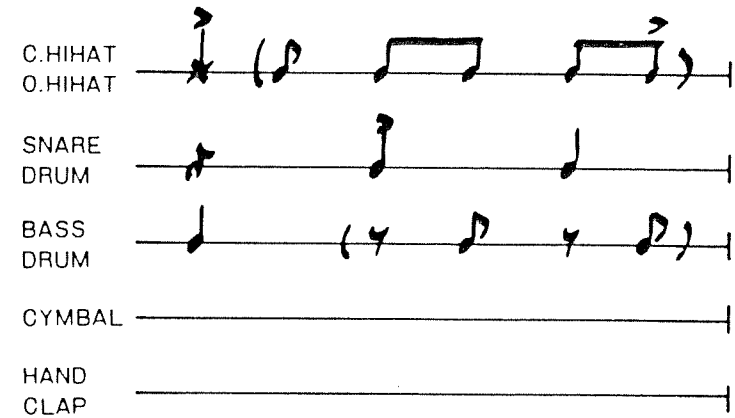
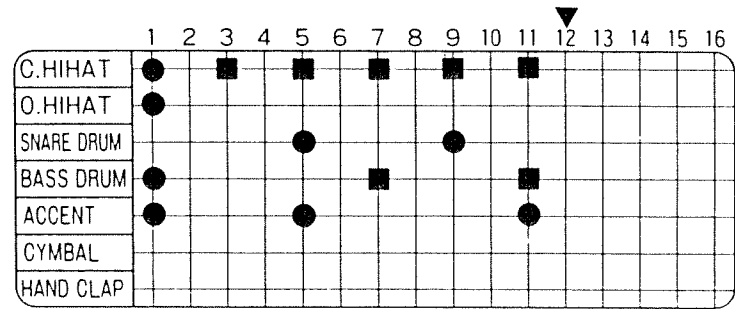

★ With the Bass Drum and Hihat in (), 8 beat Walz is obtained.

Original Memo

	1	2	3	4	5	6	7	8	9	10	11	12	13	14	15	16
C. HIHAT																
O. HIHAT																
SNARE DRUM																
BASS DRUM																
ACCENT																
CYMBAL																
HAND CLAP																

	1	2	3	4	5	6	7	8	9	10	11	12	13	14	15	16
C. HIHAT																
O. HIHAT																
SNARE DRUM																
BASS DRUM																
ACCENT																
CYMBAL																
HAND CLAP																

C. HIHAT	_____
O. HIHAT	_____
SNARE DRUM	_____
BASS DRUM	_____
CYMBAL	_____
HAND CLAP	_____

C. HIHAT	_____
O. HIHAT	_____
SNARE DRUM	_____
BASS DRUM	_____
CYMBAL	_____
HAND CLAP	_____



	1	2	3	4	5	6	7	8	9	10	11	12	13	14	15	16
C. HIHAT																
O. HIHAT																
SNARE DRUM																
BASS DRUM																
ACCENT																
CYMBAL																
HAND CLAP																



	1	2	3	4	5	6	7	8	9	10	11	12	13	14	15	16
C. HIHAT																
O. HIHAT																
SNARE DRUM																
BASS DRUM																
ACCENT																
CYMBAL																
HAND CLAP																

C. HIHAT _____

O. HIHAT _____

SNARE DRUM _____

BASS DRUM _____

CYMBAL _____

HAND CLAP _____

C. HIHAT _____

O. HIHAT _____

SNARE DRUM _____

BASS DRUM _____

CYMBAL _____

HAND CLAP _____

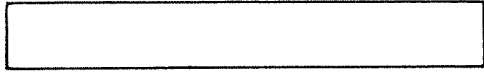

	1	2	3	4	5	6	7	8	9	10	11	12	13	14	15	16
C. HIHAT																
O. HIHAT																
SNARE DRUM																
BASS DRUM																
ACCENT																
CYMBAL																
HAND CLAP																



	1	2	3	4	5	6	7	8	9	10	11	12	13	14	15	16
C. HIHAT																
O. HIHAT																
SNARE DRUM																
BASS DRUM																
ACCENT																
CYMBAL																
HAND CLAP																

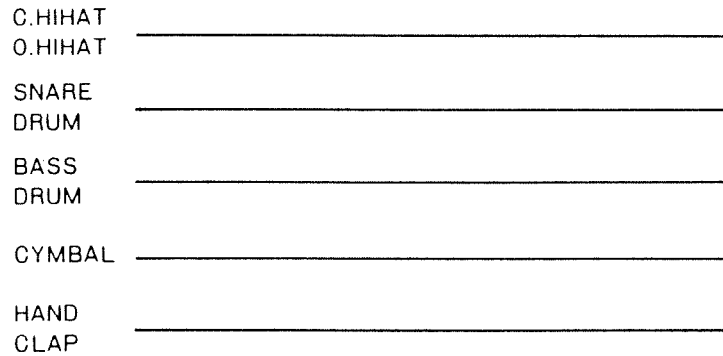
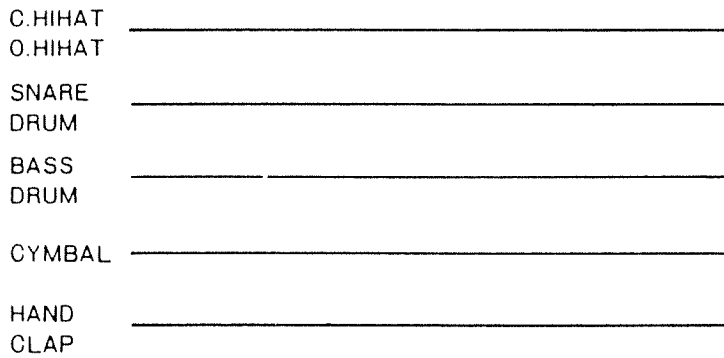

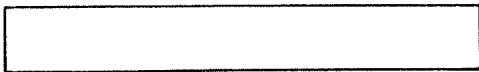

	1	2	3	4	5	6	7	8	9	10	11	12	13	14	15	16
C. HIHAT																
O. HIHAT																
SNARE DRUM																
BASS DRUM																
ACCENT																
CYMBAL																
HAND CLAP																

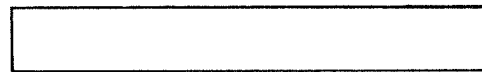

	1	2	3	4	5	6	7	8	9	10	11	12	13	14	15	16
C. HIHAT																
O. HIHAT																
SNARE DRUM																
BASS DRUM																
ACCENT																
CYMBAL																
HAND CLAP																

C. HIHAT _____

O. HIHAT _____

SNARE DRUM _____

BASS DRUM _____

CYMBAL _____

HAND CLAP _____

C. HIHAT _____

O. HIHAT _____

SNARE DRUM _____

BASS DRUM _____

CYMBAL _____

HAND CLAP _____

Specifications

■ DR-110 Dr. Rhythm GRAPHIC

● Memory Capacity

32 kinds (8 × 4 Banks)

- Preset Rhythms 16
- Free for users 16

● Step Number (within a measure)

1 to 16 steps/1 to 12 steps

● Song

128 measures × 2 (I, II)

(Maximum of continuous measures 128)

● Sound Sources

Bass Drum

Snare Drum

Cymbal

C. Hihat

O. Hihat

Hand Clap

Accent

● Liquid Crystal Display × 1

● Keys & Controls

- SHIFT Key
- BANK Selector Key (A to D)
- Rhythm Selector Keys (1 to 8)
- START Key
- STOP Key
- Instrument Keys (Accent, Bass Drum, Snare Drum, O. Hihat, C. Hihat, Cymbal and Hand Clap)
- TEMPO Knob
 - ♩ = 45 to 300
- BALANCE Knob
- ACCENT Knob
- VOLUME Knob

● Power Switch × 1

● Jacks

- DC 9V × 1

AC Adaptor Jack (Optional AC Adaptor
BOSS PSA-120, 220 or 240)

- OUTPUT (P-BUS)
Standard Phone Jack
Input/ Output Impedance 10k
- Headphones ×1
Stereo Mini Jack
+6V, 10ms pulse
- **Power**
6V (UM-3 ×4)
(AC Adaptor: 9V)
- **Consumption**
7mA (Min.) to 12mA (Max.)
- **Dimensions**
190 (W) × 110 (D) × 30 (H) mm
7-1/2(W)×4-5/16(D)×1-3/16(H) in
- **Weight**
450g/1 lb (including batteries)

Specifications are subject to change without
notice.

- **Accessories**

Dry Cell Batteries UM-3 (BR-3) × 4
Case × 1

Options

AC Adaptor BOSS PSA-120, 220 or 240

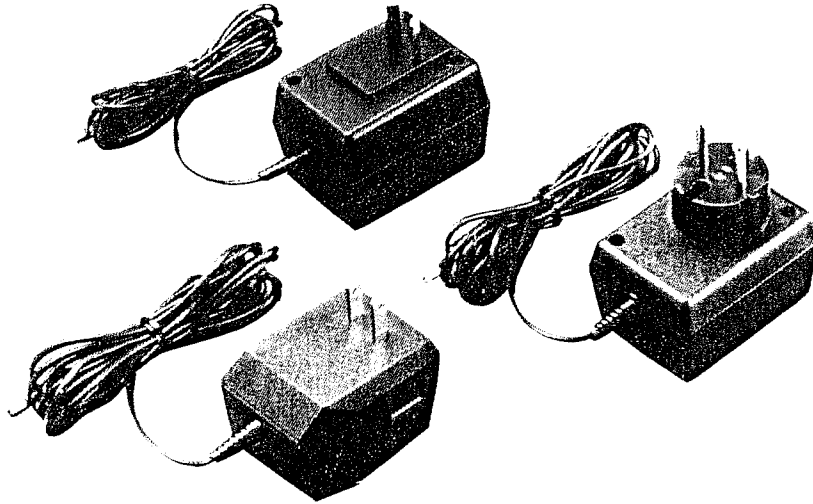

Connection Cord
PJ-1

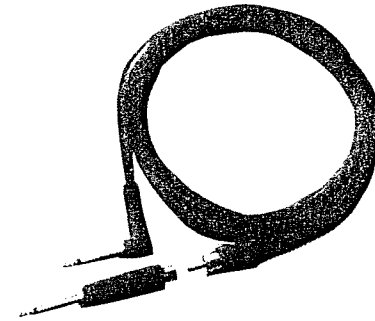

 **BOSS**
Products of Roland

 Roland®

RUS10001

UPC

RUS10001

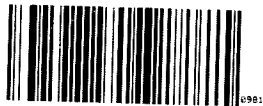

 **BOSS**