

# AVIOM®

***AN-16 / i-M***  
*A-Net Input Module*

## User Guide

---

P/N 9310 1007 0001 rev 2.00  
© 2009 Aviom, Inc.

PRO  
16®



## Certifications

ETL/cETL Listed

EMC: EN 55013, EN 55020, SAA AS/NZS 1053

Conforms to: IEC 60065, EN 60065, UL 6500-2001

Certified to: CAN/CSA E60065, KETI

RoHS Status: Pb-free



## Notice of Rights

All rights reserved. No part of this document may be reproduced or transmitted in any form or by any means—electronic, mechanical, photocopy, recording, or otherwise—without written permission of Aviom, Inc.

## Trademarks

Aviom, A-Net, the A-Net icon, Pro16, Pro64, and Virtual Data Cable are trademarks of Aviom, Inc.

All other trademarks are the property of their respective owners.

© 2009 Aviom, Inc. All rights reserved.

Information subject to change without notice.



# READ THIS FIRST

## Important Safety Instructions



1. Read these instructions.
2. Keep these instructions
3. Heed all warnings.
4. Follow all instructions.
5. Do not use this apparatus near water.
6. Clean only with a dry cloth.
7. Do not block any ventilation openings. Install in accordance with the manufacturer's instructions.
8. Do not install near any heat sources such as radiators, heat registers, stoves, or other apparatus (including amplifiers) that produce heat.
9. Do not defeat the safety purpose of the polarized or grounding-type plug. A polarized plug has two blades with one wider than the other. A grounding type plug has two blades and a third grounding prong. The wide blade or third prong are provided for your safety. If the provided plug does not fit your outlet, consult an electrician for replacement of the obsolete outlet.
10. Protect the power cord from being walked on or pinched, particularly at plugs, convenience receptacles, and the point where they exit the apparatus.



11. Only use attachments/accessories specified by the manufacturer.
12. Use only with the cart, stand, tripod, bracket, or table specified by the manufacturer, or sold with the apparatus. When a cart is used, use caution when moving the cart/apparatus combination to avoid injury from tip-over.
13. Unplug this apparatus during lightning storms or when unused for long periods of time.
14. Refer all servicing to qualified personnel. Servicing is required when the apparatus has been damaged in any way, such as when the power-supply cord or plug is damaged, liquid has been spilled or objects have fallen into the apparatus, the apparatus has been exposed to rain or moisture, does not operate normally, or has been dropped.
15. No on/off power switches are included in the system. The external power supply should be used to control power to an Aviom device. This power supply should remain readily operable.
16. The solid line over dashed line symbol (  ) indicates that the input voltage must be a DC voltage.
17. The box within a box symbol (  ) indicates that the external power supply is double insulated.



## WARNING!



TO REDUCE THE DANGER OF ELECTRICAL SHOCK DO NOT REMOVE COVERS.

NO USER SERVICEABLE PARTS INSIDE

REFER SERVICING TO QUALIFIED SERVICE PERSONNEL ONLY

To reduce the risk of fire or electrical shock, do not expose this product to rain or other types of moisture.

To avoid the hazard of electrical shock, do not handle the power cord with wet hands.

Replace fuse with same type and rating.

Operating Temperature: 10°C to 50°C (50°F to 122°F)

---

Risque de choc électrique – ne pas ouvrir. Pour réduire le risque de feu ou de choc électrique, ne pas exposer cet équipement à la pluie ou la moisissure. Pour réduire le risque de choc électrique, ne pas retirer le couvercle. Pièces non remplaçables par l'utilisateur. Confier la réparation à une personne qualifiée. Attention – utiliser seulement un fusible de rechange de même type.

Cet appareil est conforme à la section 15 de la norme FCC. Son fonctionnement est soumis aux conditions suivantes : (1) cet équipement ne doit pas causer des interférences nocives, et (2) cet équipement doit accepter toute interférence captée incluant les interférences pouvant causer des opérations indésirables.

Cet appareil numérique de Classe B est conforme à la norme NMB-003 du Canada.

---

### CAUTION:

- Using any audio system at high volume levels can cause permanent damage to your hearing.
- Set your system volume as low as possible.
- Avoid prolonged exposure to excessive sound pressure levels.

### IMPORTANT:

This equipment has been tested and found to comply with the limits for a Class B digital device, pursuant to part 15 of the FCC Rules. These limits are designed to provide reasonable protection against harmful interference in a residential installation. This equipment generates, uses and can radiate radio frequency energy and, if not installed and used in accordance with the instructions, may cause harmful interference to radio communications. However, there is no guarantee that interference will not occur in a particular installation. If this equipment does cause harmful interference to radio or television reception, which can be determined by turning the equipment off and on, the user is encouraged to try to correct the interference by one or more of the following measures:

- Reorient or relocate the receiving antenna.
- Increase the separation between the equipment and receiver.
- Connect the equipment into an outlet on a circuit different from that to which the receiver is connected.
- Consult the dealer or an experienced radio/TV technician for help.

Changes or modifications to the product not expressly approved by Aviom, Inc. could void the user's FCC authority to operate the equipment.

## Aviom, Inc. Limited Warranty

Aviom, Inc. warrants this product against defects in materials and workmanship for a period of **one year** from the date of the original retail purchase.

This warranty does not apply if the equipment has been damaged due to misuse, abuse, accident, or problems with electrical power. The warranty also does not apply if the product has been modified in any way, or if the product serial number has been damaged, modified, or removed.

If a defect is discovered, first write or call Aviom, Inc. to obtain a Return Authorization number. No service will be performed on any product returned without prior authorization. Aviom, Inc. will, at its option, repair or replace the product at no charge to you. The product must be returned during the warranty period, with transportation charges prepaid to Aviom, Inc., 1157 Phoenixville Pike, Suite 201, West Chester, PA 19380. You must use the product's original packing materials for shipment. Shipments should be insured for the value of the product. Include your name, address, phone number, description of the problem, and copy of the original bill of sale with the shipment. The Return Authorization number should be written on the outside of the box.

THIS LIMITED WARRANTY GIVES YOU SPECIFIC LEGAL RIGHTS. YOU MAY HAVE OTHER RIGHTS, WHICH VARY FROM STATE TO STATE (OR JURISDICTION TO JURISDICTION). AVIOM'S RESPONSIBILITY FOR MALFUNCTIONS AND DEFECTS IN HARDWARE IS LIMITED TO REPAIR AND REPLACEMENT AS SET FORTH IN THIS LIMITED WARRANTY STATEMENT. ALL EXPRESS AND IMPLIED WARRANTIES FOR THE PRODUCT, INCLUDING BUT NOT LIMITED TO ANY IMPLIED WARRANTIES OF MERCHANTABILITY AND FITNESS FOR A PARTICULAR PURPOSE, ARE LIMITED IN DURATION TO THE WARRANTY PERIOD SET FORTH ABOVE. NO WARRANTIES, WHETHER EXPRESS OR IMPLIED, WILL APPLY AFTER SUCH PERIOD.

AVIOM, INC. DOES NOT ACCEPT LIABILITY BEYOND THE REMEDIES SET FORTH IN THIS LIMITED WARRANTY DOCUMENT. AVIOM, INC.'S LIABILITY IS LIMITED TO THE REPAIR OR REPLACEMENT, AT OUR OPTION, OF ANY DEFECTIVE PRODUCT, AND SHALL IN NO EVENT INCLUDE INCIDENTAL OR CONSEQUENTIAL DAMAGES OF ANY KIND.

SOME STATES DO NOT ALLOW EXCLUSIONS OR LIMITATION OF IMPLIED WARRANTIES OR LIABILITY FOR INCIDENTAL OR CONSEQUENTIAL DAMAGES, SO THE ABOVE LIMITATIONS MAY NOT APPLY TO YOU.

# Warranty Information

Please record the following information for future reference:

Your Authorized Aviom Dealer:

Name: \_\_\_\_\_

Address: \_\_\_\_\_

\_\_\_\_\_

Phone: \_\_\_\_\_

Serial Numbers of Your Aviom Products: \_\_\_\_\_

\_\_\_\_\_

Date of Purchase: \_\_\_\_\_

Your Authorized Aviom Dealer is your primary source for service and support. The information recorded above will be helpful in communicating with your Authorized Aviom Dealer should you need to contact Aviom Customer Service. If you have any questions concerning the use of this unit, please contact your Authorized Aviom Dealer first. For additional technical support, or to find the name of the nearest Authorized Aviom Repair Station, check the Aviom web site at [www.aviom.com](http://www.aviom.com).

To fulfill warranty requirements, your Aviom product should be serviced only at an authorized Aviom service center. The Aviom serial number label must appear on the outside of the unit, or the Aviom warranty is void.

This manual and its contents are copyrighted by Aviom, Inc. All rights are reserved by Aviom, Inc. This document may not, in whole or in part, be copied, photocopied, reproduced, translated, or reduced to any electronic medium or machine-readable form without prior written consent from Aviom, Inc.

The software and/or firmware contained within Aviom products is copyrighted and all rights are reserved by Aviom, Inc.

Although every effort has been made to ensure the accuracy of the text and illustrations in this manual, no guarantee is made or implied as to the accuracy of the information contained within.

# TABLE OF CONTENTS

<b>Welcome</b>	1
<b>Features</b>	1
<b>Conventions Used in this Document</b>	1
AN-Series	1
Using Personal Mixers	2
Cat-5 Cables	2
A-Net Distributors	2
<b>Package Contents</b>	3
<b>About A-Net</b>	3
<b>Compatibility with Pro64</b>	4
<b>About Category 5</b>	4
<b>Cat-5 Cables</b>	5
Cable Lengths	5
<b>AC Line Conditioning</b>	7
<b>Rack Mounting</b>	7
<b>EtherCon Connector</b>	8
<b>Cleaning and Maintenance Information</b>	8
<b>Front Panel</b>	9
<b>Rear Panel</b>	11
<b>Panel Descriptions</b>	13
<b>AN-16/i-M Front Panel</b>	13
Channel LEDs	13
Phantom Power Switch	14
Gain Knob	14
Low Cut Filter (Rolloff)	14
Phase Invert Switch	15
The Stereo Link Switch	15
Power LED	16
<b>AN-16/i-M Rear Panel</b>	17
Power Connector	17
Channel Input Jacks	18
Channel Thru Jacks	19
Channel Inserts	19
Direct Line Outputs	19
<b>A-Net Connections</b>	20
A-Net Main Out	20
A-Net Aux Out	20
A-Net Expansion	21
<b>Series and Parallel Connections</b>	21
Connecting A-Net Devices in Series	21
Parallel A-Net Routing	22
Using an A-Net Distributor	22
<b>Connecting an Output Module</b>	23
Adding Splits	23

Adding Personal Mixers . . . . .	24
<b>Extending A-Net Cable Runs . . . . .</b>	<b>25</b>
<b>Audio Networks . . . . .</b>	<b>26</b>
<b>16-Channel Systems . . . . .</b>	<b>26</b>
<b>32-Channel Systems . . . . .</b>	<b>27</b>
A-Net Expansion . . . . .	27
<b>32-Channel Snake . . . . .</b>	<b>29</b>
16 Channels Send by 16 Channels Return . . . . .	30
<b>Adding More Audio Outputs . . . . .</b>	<b>32</b>
Using an A-Net Distributor . . . . .	33
<b>64-Channel Systems . . . . .</b>	<b>34</b>
System Bridge . . . . .	34
Connecting the System Bridge . . . . .	35
Configuration Notes . . . . .	36
Expanding a Network . . . . .	37
Using Multiple System Bridges . . . . .	38
<b>Specifications . . . . .</b>	<b>41</b>
<b>Block Diagram . . . . .</b>	<b>43</b>
<b>Dimensions . . . . .</b>	<b>44</b>
<b>Warranty Registration . . . . .</b>	<b>49</b>



# Welcome

Thank you for purchasing the **AN-16/i-M Mic Input Module**, designed for use with the Pro16® Monitor Mixing System and audio networking products. All Pro16 products are powered by A-Net®, Aviom's proprietary data transmission protocol designed especially for the unique demands of live streaming audio. This User Guide is designed to familiarize you with your new product and to have your system up and running in no time.

## Features

The AN-16/i-M Mic Input Module is part of Aviom's Pro16® Series of products; it can be combined with other Pro16 devices to create monitor systems, digital snakes, and audio distribution systems for applications such as live performance, broadcast, and recording.

AN-16/i-M Mic Input Module Features:

- Sixteen audio channels
- Mic/line combo input jacks (XLR and TRS)
- +48 volt phantom power on each channel
- Phase Invert switch per channel
- 85Hz low cut rumble filter per channel
- Channel link switches for stereo channel pairing
- Splitter provides sixteen Thru outputs
- Balanced insert points per channel
- Two parallel A-Net outputs
- EtherCon® RJ45 connectors
- A-Net Expansion port for 32-channel operation

## Conventions Used in this Document

### AN-Series

The AN-16/i Input Module, AN-16/i-M Mic Input Module, and AN-16/o Output Module are referred to generically as the **AN-Series** of products.

When describing audio network configurations, the AN-16/i Input Module and most Pro16 console interface cards can be substituted anywhere the AN-16/i-M Mic Input Module is used.

## Using Personal Mixers

It is possible to create an audio distribution and personal monitor system using any combination of Aviom AN-Series and Personal Mixer products, including the A-16II, and A-16R.

When referring to the use of the personal mixers in a system in general, the terms **A-16II Mixer** or **Personal Mixer** are used to describe a case where a standard A-16II Personal Mixer or a rack mounted A-16R Personal Mixer (with/without the optional A-16CS Control Surface) can be used.

## Cat-5 Cables

In most cases Cat-5e, Cat-6, and Cat-6e cables can be interchanged. When speaking about interconnections between components in a system, the term *Cat-5* is used generically to indicate the use of any of the applicable cable types.

## A-Net Distributors

The A-16D and A-16D Pro A-Net Distributors are referred to generically as *A-Net Distributors*.

# Package Contents

Check the contents of the shipping box carefully before making connections and continuing with installation.

The contents of the AN-16/i-M Mic Input Module box include:

- One AN-16/i-M Mic Input Module
- One IEC power cable
- User documentation

Options for your system include

- Cat-5e interconnect cables
- AN-16SBR System Bridge
- Pro16 monitor mixing products such as the A-16II Personal Mixer or A-16R rack mount Personal Mixer
- AN-16/o Output Module
- A-16D A-Net Distributor
- A-16D Pro A-Net Distributor

Included in this document is a Warranty Registration; be sure to fill out the form and return it to Aviom, Inc. via mail or fax as soon as possible.

## About A-Net

The Pro16<sup>®</sup> version of A-Net<sup>®</sup> is a high-speed data transmission protocol capable of sending and receiving high-quality digital audio using readily available Cat-5 cables. A-Net is a proprietary technology developed by Aviom.



A-Net is based on the physical layer of Ethernet, a Local Area Network (or LAN) technology. This provides A-Net with a mature and robust base on which to build. However, it is important to note that A-Net devices are not compatible with Ethernet devices.

As used in the Pro16 series products, the A-Net signal carries sixteen channels of digital data from the AN-16/i-M Mic Input Module to each A-Net device connected to the system.

Some of the benefits of using A-Net to transmit digital audio are:

- Virtually no latency
  - No ground loops
  - Easy cabling using readily available components
  - An unlimited number of A-Net devices can be used in a system
  - Ease in spanning long distances between system components
- ✓ **NOTE:** While the Cat-5e cables and connectors used on your Aviom products look like typical computer Ethernet network connections, do not connect computers, routers, or other home and business networking equipment to your Aviom products.

Other options for protection of your equipment include the use of an AC line conditioner or a battery backup system (sometimes referred to as an *uninterruptible power supply*, or UPS).

## Compatibility with Pro64

Many Pro16 products can be connected to a Pro64® A-Net system with the addition of the ASI A-Net Systems Interface. The ASI translates Pro64 A-Net data into Pro16 data and separates the 64-channel Pro64 stream into up to four 16-channel Pro16 outputs, depending on the Pro64 sample rate being used.

Only Pro16 devices that have an A-Net In port such as Personal Mixers, A-Net Distributors, and output modules are compatible with Pro64 and the ASI. Pro16 input modules and console cards cannot send their data into a Pro64 network.

## About Category 5

Category 5 (sometimes referred to as *Cat-5*) describes a commonly used type of high performance network cabling. It is used mainly for data transmission purposes to connect computers, modems and other devices. A standard Category 5 patch cable consists of four twisted pairs of copper wire terminated by RJ45 male connectors. The cable assembly is used to provide connectivity between any two Cat-5 female outlet jacks. A variation, called Category 5e (or Cat-5e), uses additional twists in the cable to reduce interference in high-speed network applications. In general, when using long cable lengths, select Cat-5e cables for best performance. **Use Cat-5e Unshielded Twisted Pair (UTP) cables or better for all A-Net applications.**

The RJ45 connector looks similar to the connectors found on a telephone system, only larger. The twisting of the wire pairs helps to shield the cable from unwanted interference from electrical fields or radio interference (sometimes referred to as “RF”). Cat-5 cabling supports frequencies up to 100 MHz and speeds up to 1000 Mbps.

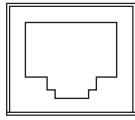

RJ45 Jack

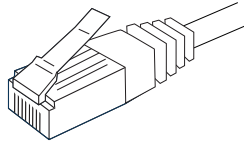

Cat-5 Cable

## Cat-5 Cables

The cables used with your Aviom system are interchangeable with any standard Cat-5e cables. If you need a longer cable for a particular application, any computer store should be able to supply you with an appropriate cable. A qualified technician should be able to build custom cables to any length (up to the maximum of 500 feet (150 meters) between components).

For fixed or permanent installations, you have the option of running Cat-5 cables inside walls and terminating them with readily available wall panel connectors that include the RJ45 jack. (Solid wire is recommended for permanent installations.)

In addition to standard Cat-5e cables, Category 6 (Cat-6) cables can also be used.

- ✓ **NOTE:** When purchasing Category 5e cables, be sure to buy only standard Cat-5e UTP cables, not those sold as crossover cables. A crossover cable is used for file transfer between two computers and is not compatible with your Aviom equipment.

## Cable Lengths

Cat-5e cables used with your Aviom products can be up to 500 feet (approximately 150 meters) in length between devices. The maximum cable length specification applies to the cable connected between the AN-16/i-M Mic Input Module and the first Pro16 output module (or Personal Mixer) in your system as well as for cable runs between each additional Pro16 A-Net compatible device in your system.

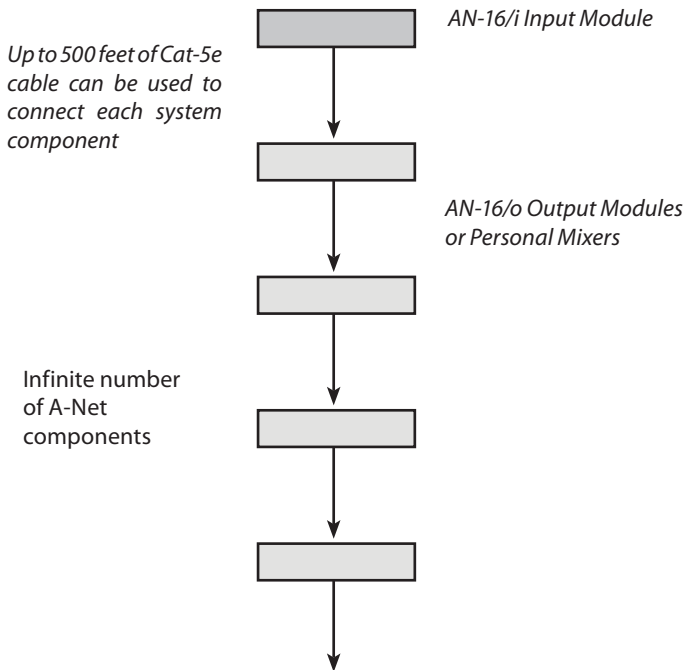

Your cable length performance will be affected by a number of factors including the quality of the cables used, and the number of devices such as cable couplers used or passive wall panel interconnections in use. Use Cat-5e cable for best performance wherever possible. Stranded or solid Cat-5e cable can be used.

When using the optional AN-16SBR System Bridge, the cable length specification applies to the *total* cable length between the two A-Net devices being connected with the AN-16SBR System Bridge. This is similar to what happens when using an inline coupler to extend cable lengths.

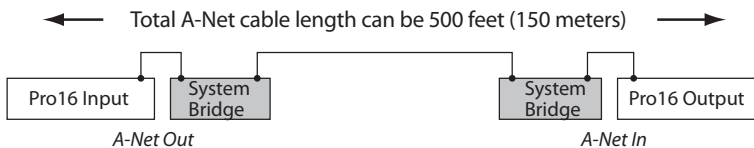

Pre-made cables in a variety of lengths and colors are available at most computer outlets. Cables can be extended by using a simple passive device called an *inline coupler* to add length to existing cables (as long as you do not exceed the specified maximum cable length). If you need a longer cable on occasion, this is a simple solution. Note that it is possible that the maximum

cable length specification can be compromised by using inline couplers or other passive connection devices.

## AC Line Conditioning

Aviom products are digital devices and as such are sensitive to sudden spikes and drops in the AC line voltage. Changes in the line voltage from lightning, power outages, etc. can sometimes damage electronic equipment.

To minimize the chance of damage to your equipment from sudden changes in the AC line voltage, you may want to plug your equipment into a power source that has surge and spike protection. Power outlet strips are available with built-in surge protection circuits that may help protect your equipment.

Other options for protection of your equipment include the use of an AC line conditioner or a battery backup system (sometimes referred to as an *uninterruptible power supply*, or UPS).

## Rack Mounting

The AN-16/i-M Mic Input Module is designed to be installed in a standard 19-inch audio equipment rack. Each unit takes up three standard rack spaces (19 inches wide by 5.25 inches high).

The rack ears on each side of the device are designed to support the weight of the AN-16/i-M without additional hardware. Each rack ear contains holes for two screws per side. Always support the unit with all four screws.

To rack mount Mic Input Module, position it in the equipment rack at the desired location. Use standard rack-mounting screws (10-32 size) to attach the unit to your rack hardware. Tighten all four screws firmly, but avoid overtightening.

Aviom suggests the use of non-metallic washers between the rack-mounting screws and the device's finished surface to avoid marring the painted finish on your Aviom products.

Always allow adequate ventilation for devices mounted in equipment racks. Avoid placing your AN-16/i-M directly above or below other rack-mounted devices that produce high levels of heat, such as power amps.

# EtherCon Connector

Some Aviom products use EtherCon® Cat-5 connectors. The Neutrik EtherCon connector is a dual RJ45 type connector. It can receive a standard Cat-5e cable or a cable fitted with the special heavy-duty EtherCon connector.

When using a standard Cat-5e cable, plug the cable into the center of the jack; release the cable by pressing on the small plastic tab built into the cable connector.

The locking EtherCon connector is similar to an XLR cable, the kind commonly used on microphones. Insert an EtherCon equipped cable into the jack until it clicks and locks in place. To remove the cable, press on the metal release tab at the top of the panel-mounted EtherCon jack and pull the connector outward.

## Cleaning and Maintenance Information

The exterior of your Aviom products should be cleaned with a dry, soft, lint-free cloth. For tougher dirt, you can use a cloth slightly dampened with water or with a mild detergent.

When cleaning your Aviom products, never spray cleaners directly onto the product surfaces. Instead, spray a small amount of the cleaning solution onto a clean cloth first. Then use the dampened cloth to clean the product.

- ✓ **NOTE:** Never use solvents or abrasive cleaners on the finished surfaces of your Aviom products.



# Front Panel

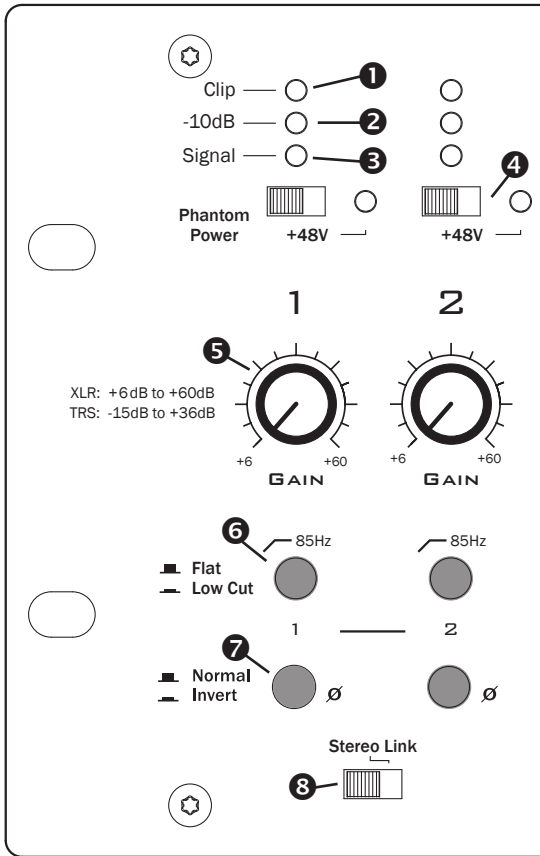

	FUNCTION
1	Clip LED
2	-10dB signal level LED
3	Signal present LED
4	+48 volt Phantom Power switch and LED
5	Rotary Gain knob
6	85Hz Low Cut rolloff
7	Phase Invert switch (polarity)
8	Stereo Link switch

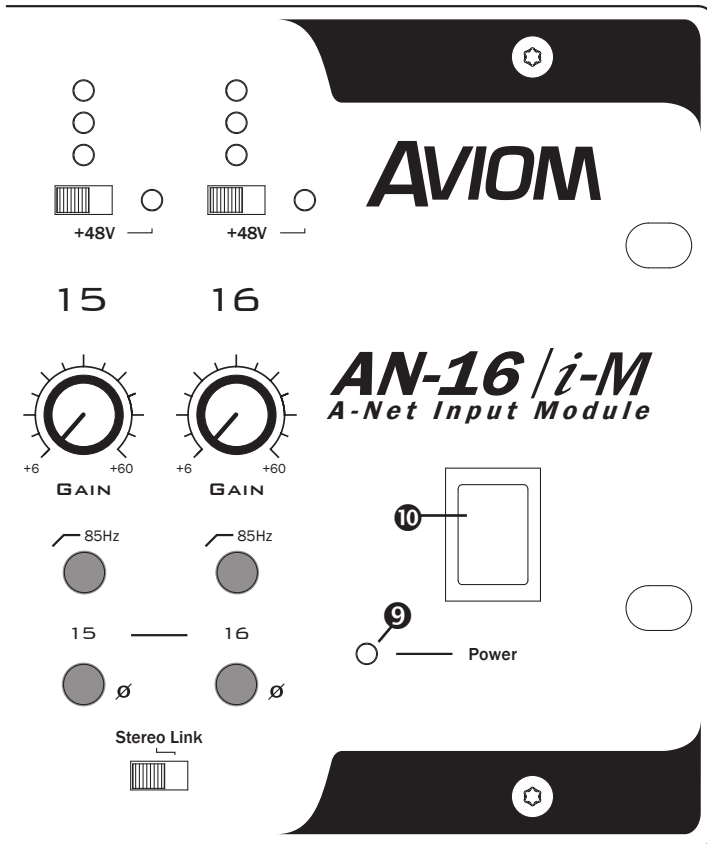

	FUNCTION
<b>9</b>	Power LED
<b>10</b>	Power switch

# Rear Panel

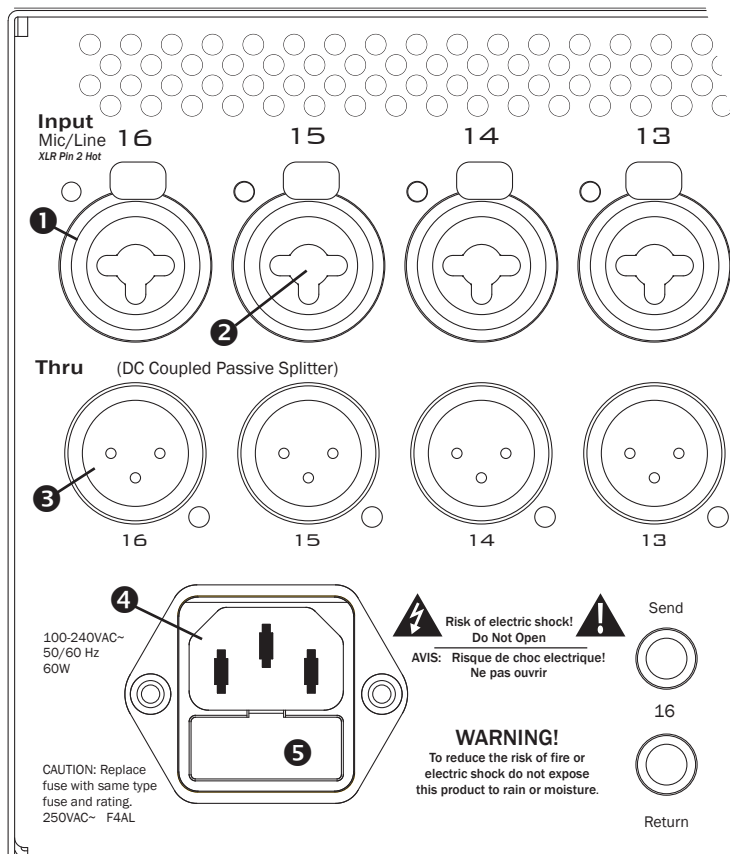

	FUNCTION
1	XLR mic input
2	Balanced TRS line-level input
3	Mic Thru jack, XLR
4	AC power inlet, IEC
5	Fuse compartment (F4AL)

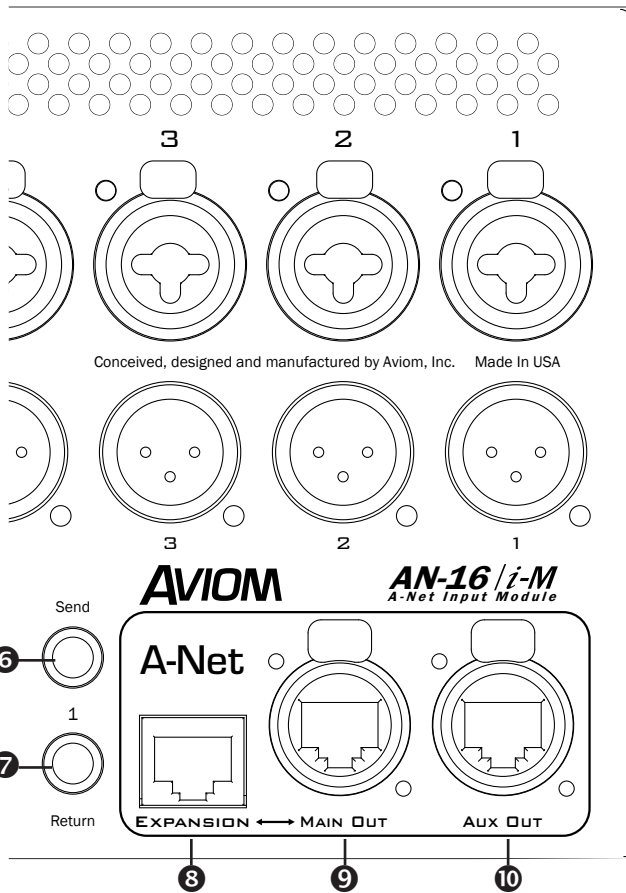

	FUNCTION
<b>6</b>	Channel insert Send jack
<b>7</b>	Channel insert Return jack
<b>8</b>	A-Net Expansion jack
<b>9</b>	A-Net Main Out jack
<b>10</b>	A-Net Aux Out jack

# Panel Descriptions

This section explains the basic layout of your new Aviom product. The diagrams on the previous pages can be used as a quick visual guide to the location of the components of the AN-16/i-M mentioned in this section.

## AN-16/i-M Front Panel

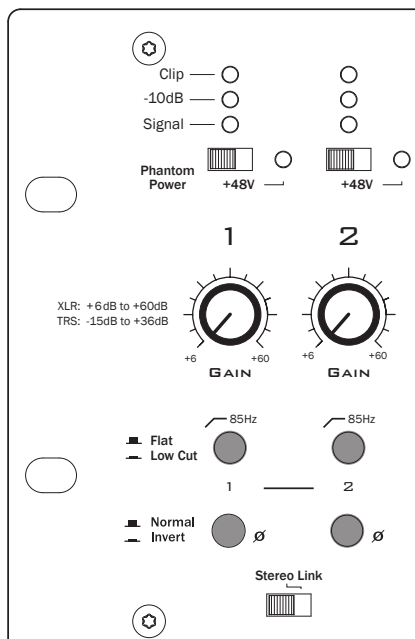

The front panel channel strip of the AN-16/i-M

The front panel of the AN-16/i-M contains the channel input strip, Stereo Link switches, Signal Present LEDs, Clip LEDs, power indicator, and the AC power switch.

## Channel LEDs

The numbered channels on the AN-16/i-M front panel correspond to the sixteen analog (mic or line) audio inputs on the rear panel of the unit. They are grouped together in pairs—Channels 1 and 2, Channels 3 and 4, etc. Each channel contains three LEDs, one showing that there is an audio signal

present, one LED to display when signal levels reach a point that is 10dB from maximum level, and another used to indicate that the input to a channel is causing audio clipping.

The lower LED, marked *Signal*, will light as long as an audio signal of at least -40dB is present on the channel. It provides an easy way to confirm that audio is indeed passing into—and being processed by—the AN-16/i-M.

The center LED lights when audio signals reach a level that is within 10dB of the maximum level before clipping.

The upper LED is marked *Clip*. It lights when input signal levels exceed the maximum of 0dB. If the Clip LED is lighting frequently, you should lower the level of the audio source using the AN-16/i-M Gain knob.

## Phantom Power Switch

Phantom power is provided for condenser mics on each channel. Engaging the Phantom Power switch for a channel delivers +48 volts to the XLR jack on the rear panel of the AN-16/i-M. The LED lights to indicate that phantom power is on.

- ✓ **NOTE:** Avoid using phantom power with line-level devices.

Use caution when activating phantom power to avoid damage to ribbon microphones, for example.

## Gain Knob

Each channel has a rotary Gain knob with variable gain. Two gain ranges are available, one for mic-level signals connected via the XLR jack and another for line-level signals connected to the TRS balanced inputs on the rear panel combo jacks.

The XLR input has a gain range of +6dB to +60dB. The TRS input gain range is from -15dB to +36dB. The XLR input will be most often used with microphone signals, although it can also accept line-level signals.

## Low Cut Filter (Rolloff)

Below the Gain knob is the Low Cut switch. It provides a low frequency rolloff at 85Hz that can be used to minimize low frequency artifacts such as vibration noise and rumble. Press the switch in to engage the rolloff. In the up position, marked *Flat*, the low cut filter is not engaged.

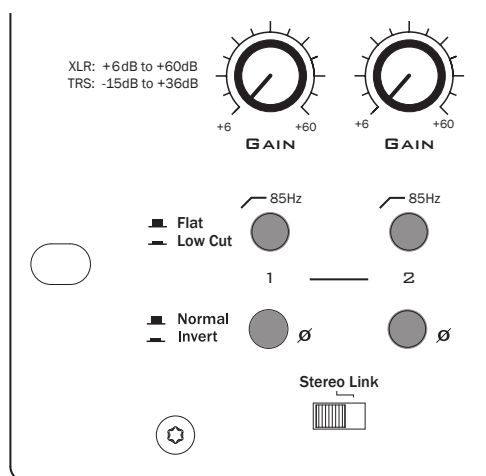

The channel gain, filter, and phase invert section of the channel strip

## Phase Invert Switch

The Phase Invert switch alters the polarity of the audio signal on a per-channel basis. It can be used to correct phase anomalies that sometimes occur when using multiple microphones on the same sound source (such as a drum kit). To invert the phase of a channel, set the channel's Phase switch to the *in* position.

## The Stereo Link Switch

The AN-16/i-M Mic Input Module provides an easy solution for stereo input sources such as mixer sub-groups, keyboards, effects device outputs, CD players, etc. The Stereo Link switch is most useful when used to turn a pair of adjacent channels into a stereo channel pair that can be controlled as a single source on the Pro16 Personal Mixer products, including the A-16II and A-16R.

When using the AN-16/i-M Input Module with AN-16/o Output Modules alone to create an audio network or digital snake, the setting of the Stereo Link switch will have no effect.

There are eight Stereo Link switches on the front panel of the AN-16/i-M. They can be used in any combination, as your needs require. The Stereo Link switch is located between two channels—one odd and one even. Stereo Links always affect adjacent channels (for example channels 1 and 2, or channels 13 and 14).

The default setting, with the Stereo Link switch to the left, allows independent control of each input channel from A-Net Personal Mixer products connected to the system.

To link channels together as a stereo input, move the Stereo Link switch to the right. (Moving the switch to the link position causes all Personal Mixers connected to the system (including the A-16CS Control Surface used with the A-16R) to instantly update their channel status.)

Some things to keep in mind about linked channels:

- The position of the Stereo Link switch does *not* affect the audio in the AN-16/o Output Module.
- Linking channels affects *all* A-Net Personal Mixers connected to the system.
- Any combination of stereo and mono channels can be used.
- If you want to control two input channels as a stereo source, they must be connected to an odd and even pair of channels, as indicated by the graphics on the AN-16/i-M front panel.
- Changes to the Stereo Link status can be made on the fly, with audio running through the system.
- All Personal Mixers will instantly update their channel status if the Link switch position is changed for any channel pair.
- Link status is not saved when you create a Preset on A-16II or A-16R Personal Mixers.
- Changing the channel link status may affect Groups you have created on A-16II and A-16R Personal Mixers in some cases.

## Power LED

The right side of the AN-16/i-M Mic Input Module front panel interface also contains the Power LED. This indicator shows that power is connected to the unit. When the AN-16/i-M is powered up, a valid A-Net signal is being generated.



# AN-16/i-M Rear Panel

On the rear of the AN-16/i-M Mic Input Module are the power connector (with fuse), A-Net connections, the sixteen mic/line balanced analog audio inputs, the sixteen audio Thru jacks, and the balanced insert Send/Return jacks.

Signal routing into and out of the AN-16/i-M Mic Input Module has been designed to be extremely flexible, allowing the AN-16/i-M to integrate into virtually any audio environment.

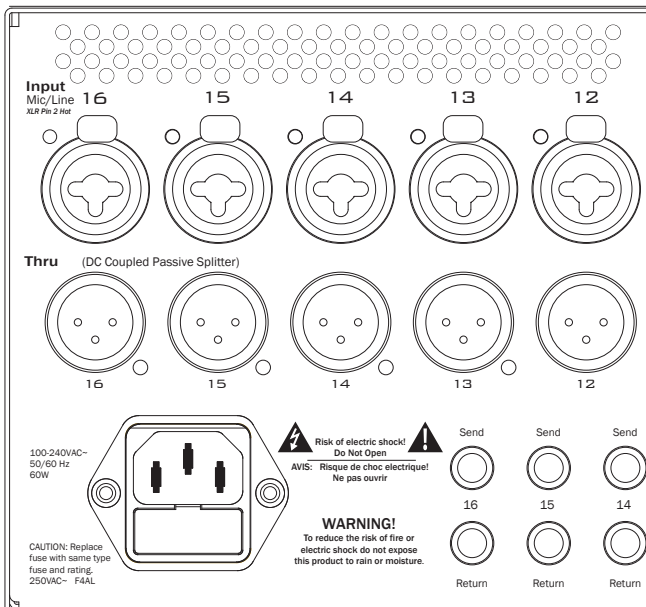

The rear-panel I/O section of the AN-16/i-M

## Power Connector

The AN-16/i-M Mic Input Module comes with an internal switching-type power supply. This type of power supply can be used worldwide with a wide range of AC wall current output voltages. You do not need to replace the power supply if the unit will be used in countries where current voltages are different if you travel with your Aviom gear occasionally. (You may, however, need plug adapters to allow the power supply to be connected to wall outlets internationally since many countries use different physical plug layouts for their power systems.)

## Channel Input Jacks

The rear panel of the AN-16/i-M Mic Input Module contains sixteen audio input jacks. Microphones or line-level audio signals can be used. The combo jack used for audio input can accept an XLR connector or a ¼-inch TRS connector.

The XLR input is designed to accept microphone-level signals from dynamic or condenser microphones. Phantom power (+48V) is supplied for each channel for use with condenser mics. The XLR input can also accept a line-level audio signal. But, be aware that using the XLR jack for a line-level input can cause clipping with some extremely hot audio signals. If adjusting the Gain knob on the front panel does not reduce the clipping, use the TRS input instead.

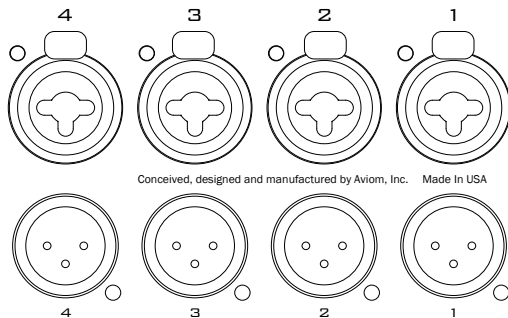

Channel inputs accept XLR or TRS plugs; all Thru connections are XLR male.

The ¼-inch part of the combo jacks can accept balanced or unbalanced line-level signals using TRS or TS plugs.

- ✓ **NOTE:** Do not connect guitars or other high impedance sources to the line-level inputs. Use a direct box to convert a guitar or bass pickup's low level magnetic signal to mic level.

Balanced signals (sometimes referred to as TRS, for Tip, Ring, and Sleeve) are found on many professional audio devices. The ¼-inch connector used for balanced audio wiring has three conductors: the tip, the ring, and the sleeve. The balanced wiring system is ideal for keeping noise out of the audio signal from sources such as radio interference (sometimes called "RF").

Unbalanced audio signals (sometimes referred to as TS, for Tip and Sleeve) are found on many effects processors, music keyboards, and consumer electronics. Only two connectors on the ¼-inch plug are used, the tip and the sleeve. A standard musical instrument cable (sometimes called a guitar cord) uses this configuration, for example.

## Channel Thru Jacks

The sixteen XLR balanced audio Thru jacks on the AN-16/i-M provide an exact copy of the mic signal plugged into the Input jack just above it. This provides a passive splitter that can send a copy of the audio inputs to an analog audio mixer used for monitors in a digital snake installation, for example.

No front-panel adjustments are passed on to the Thru connector with the exception of the phantom power used by condenser mics.

## Channel Inserts

Each of the sixteen audio channels has a dedicated set of insert send/return jacks. The insert jacks are ¼-inch balanced TRS and are designed to allow audio processors such as compressor/limiters to be added to each channel.

Connect a cable from the channel's **SEND** jack to the audio input of the effects processor. Connect another ¼-inch cable from the device's output to the **RETURN** jack on the AN-16/i-M channel to be processed.

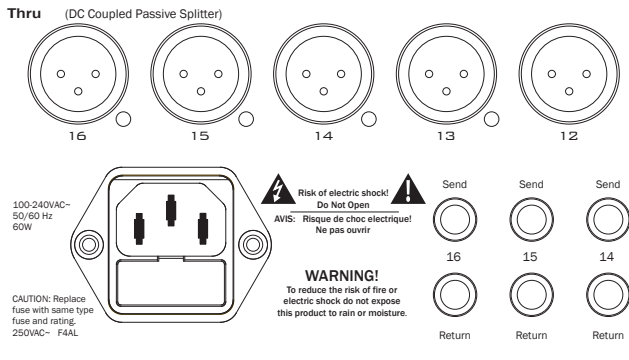

The Insert Send jack can be used as a direct line output.

## Direct Line Outputs

The AN-16/i-M Input Module can also be used as a stand-alone mic preamp. The insert send/return functions as a line output if only the Send jack is used.

To send a channel's audio signal to another line-level device, connect a cable (TS or TRS) from the channel's **SEND** jack to the input of the device. Do not connect a cable to the AN-16/i-M **RETURN** jack as this will break the line out connection, creating an insert send/return path, as described above.

# A-Net Connections

Three A-Net connections appear on the rear panel of the AN-16/i-M Input Module. There are two A-Net Out jacks and one A-Net Expansion jack.

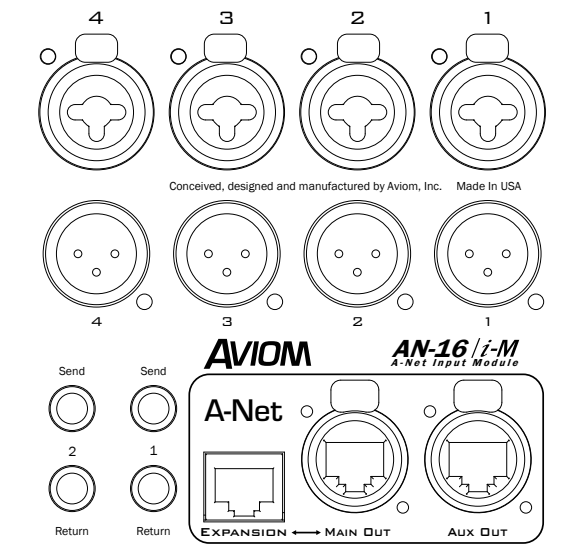

A-Net outputs and A-Net Expansion connections

## A-Net Main Out

The A-Net Out jack sends the A-Net data from the AN-16/i-M to an A-Net compatible device such as the AN-16/o Output Module. The AN-16/i-M has two A-Net Out jacks. The first, marked Main Out, is designed to be used as the primary A-Net connection to other devices. It has the ability to be used with the Expansion jack when creating digital snakes of up to 32 channels (described later).

## A-Net Aux Out

The second A-Net Out jack, labeled Aux Out, carries only the A-Net signal generated by the AN-16/i-M locally and cannot be used with the Expansion jack in a 32-channel snake or audio network configuration.

Use any standard Cat-5e cable for connections between devices. Remember that the maximum cable length between A-Net devices is 500 feet (150

meters), including connections using System Bridges.

When a proper A-Net connection between the AN-16/i-M Mic Input Module and an AN-16/o Output Module (or Pro16 Series Personal Mixer) exists, the A-Net Active LED on the receiving device will light.

## A-Net Expansion

The A-Net Expansion jack is used when creating a 32-channel digital snake or audio network using at least two AN-16/i-M Mic Input Modules and two AN-16/o Output Modules or other compatible output devices. Using the A-Net Expansion jack allows thirty-two channels of data to travel down a single Cat-5e cable up to 500 feet (150 meters) to the destination AN-16/i-M or AN-16/o units.

## Series and Parallel Connections

In a simple system, the easiest connection method uses what is called a *daisy-chain*. That is, each A-Net device is connected in series. The first device in the chain receives the A-Net signal from the AN-16/i-M Mic Input Module. Each successive A-Net compatible device gets its A-Net connection from the A-Net Out jack of the device preceding it in the chain.

There is one drawback to this connection method, however. If one A-Net device in the chain is disconnected from the A-Net signal chain, all units beyond this point will not get any audio until the unit is reconnected to a valid A-Net source.

### Connecting A-Net Devices in Series

The diagram below illustrates a series connection of A-Net devices.

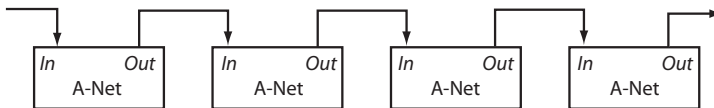

In this diagram, A-Net is connected from device to device using Cat-5e cable. The A-Net Out port on the first device connects to the A-Net In port on the next, and so on.

A parallel A-Net connection solves that problem. By using the optional A-16D or A-16D Pro A-Net Distributors, parallel A-Net connections are possible. In fact, any combination of series and parallel connections can be used to solve even the most complex audio routing problems.

## Parallel A-Net Routing

Connecting A-Net devices in parallel involves the addition of an A-Net distributor. Any number of A-Net distributors can be added, creating an infinite number of digital splits.

### Using an A-Net Distributor

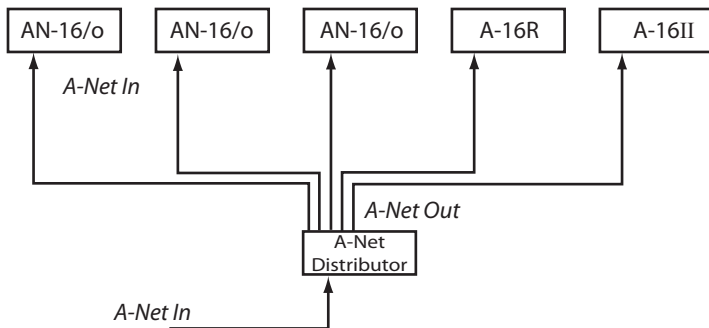

A variety of A-Net compatible components are shown connected in parallel to an A-16D or A-16D Pro A-Net Distributor.

The A-Net output from the A-16D or A-16D Pro A-Net Distributor in the diagram above is connected to each Pro16 A-Net compatible device's A-Net input with a Cat-5e cable. Removing one A-Net device has no effect on the other A-Net outputs being used.

When configuring a Pro16 system, modules can be connected in any order; simply connect A-Net Out to A-Net In as needed.

# Connecting an Output Module

To convert the mic- or line-level signals connected to the AN-16/i-M back to 16 discrete channels of analog audio, the AN-16/i-M needs to be connected to a compatible A-Net output module such as the AN-16/o Output Module. Simply connect a Cat-5e cable from **A-Net Out** on the AN-16/i-M to **A-Net In** on the output module.

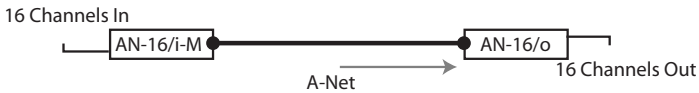

Sixteen mic/line sources are output as analog audio up to 500 feet away.

## Adding Splits

When additional copies of the same audio channels are needed—a digital split—using A-Net allows easy system expansion. The A-Net Out jack on the AN-16/o can be used to send an exact copy of the audio data being received to as many AN-16/o Output Modules as required, creating an infinite number of digital splits each of which can be up to 500 feet (150 meters) apart.

The diagram below shows a simple system with one AN-16/i-M Mic Input Module connected to one AN-16/o Output Module. Audio connected to the AN-16/i-M is delivered to the AN-16/o via A-Net. By connecting additional AN-16/o Output Modules, any number of exact copies of the sixteen input channels can be added. Remember, cable runs between devices can be up to 500 feet (150 meters) for added flexibility.

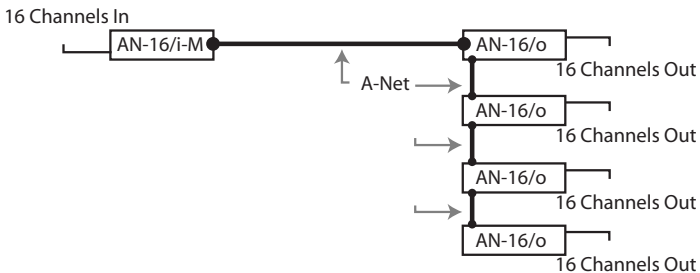

16 inputs, 16 outputs, and 3 digital splits

To create a sixteen channel digital snake with splits:

- Connect mic/line audio sources to the inputs of the AN-16/i-M
- Connect the **A-Net Out** jack on the AN-16/i-M to the **A-Net In** jack on the first AN-16/o Output Module.
- Expand the system by connecting a Cat-5e cable from the **A-Net Out** of the first AN-16/o Output Module to the **A-Net In** jack on the next AN-16/o Output Module
- Repeat this same patching as needed for each additional AN-16/o added to the system.
- Connect the audio outputs of each AN-16/o.

## Adding Personal Mixers

A Pro16 digital snake can be expanded to include Aviom's A-16II and A-16R Personal Mixer products as well. As seen in the previous section, the A-Net Out jack on any Pro16 A-Net compatible device can be used to send a copy of the sixteen channels of audio data from the input module to another A-Net compatible device.

The following diagram shows a 16-channel system with one AN-16/i-M used for the input module and two different types of expanded outputs.

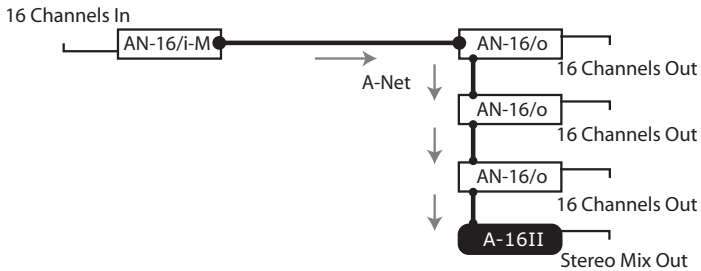

The 16 inputs from the AN-16/i-M can be sent digitally to any compatible Pro16 device using A-Net.

Any number of A-16II or A-16R Personal Mixers can be added using this method. In fact, it's important to remember that *any* A-Net compatible device can be added to a system, connected via daisy-chain or parallel.



# Extending A-Net Cable Runs

To go longer than the maximum specified distance A-Net allows (500 feet, 150 meters), the A-16D (or A-16D Pro) A-Net Distributor can be used as a signal repeater. Simply insert the A-16D or A-16D Pro into the A-Net stream at the 500-foot point and the A-Net signal will be refreshed. Another 500 feet/150 meters of cable can be added. This process can be repeated as many times as required to extend cables.

For extremely long distance application, fiber optic cable can be used to span distances up to 50 miles (80km) with the use of devices called *media converters*. A media converter changes the Ethernet-based A-Net signal to fiber optical at the source location and then back to Cat-5 at the destination. Several companies make media converters that can be used with your Aviom equipment.

# Audio Networks

Pro16 A-Net input and output modules can be combined to create digital snakes and audio networks of up to sixty-four audio channels with unlimited expansion. When more than sixteen channels of audio are required in a Pro16 system, there are several options available.

Systems using sixteen or thirty-two audio channels can be configured with no additional hardware using the built in A-Net Expansion port. For systems larger than thirty-two channels, Aviom offers the AN-16SBR System Bridge as an option. The System Bridge allows up to four A-Net streams to be combined into a single Cat-5e cable for distribution over long distances.

## 16-Channel Systems

The simplest form of digital snake using A-Net devices is one input module connected to one output module. For example, the AN-16/i-M can be connected with one Cat-5e cable to an AN-16/o Output Module located at the mix position to deliver sixteen discreet line-level audio signals to a front-of-house (FOH) mixing console.

The flexibility of A-Net allows far more than just the simple snake configuration outlined above, however. In fact, any number of Pro16 A-Net devices can be connected to a single input module. This allows the creation of infinite numbers of signal splits, with each additional A-Net device being located up to 500 feet (150 meters) away. Audio splits can be used to send digital copies of the audio signals from the input module to a live sound mixer, a recording system, remote broadcast truck, and a live television broadcast facility simultaneously with no signal degradation.

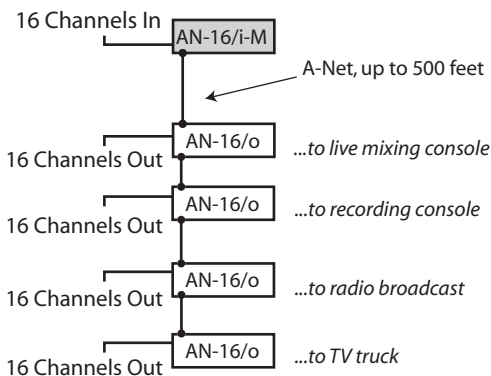

16 mic/line inputs are delivered to 4 output locations.

## 32-Channel Systems

Aviom's Pro16 Series of audio network products work in groups of sixteen channels. Audio networks of thirty-two channels can be configured as:

- 32 channels send by zero channels return (32 x 0)
- 16 channels send by 16 channels return (16 x 16)
- 0 channels send by 32 channels return (0 x 32)

The descriptions above are similar to those used for traditional analog audio snakes. The configurations refer to the number of audio channels used as inputs on each side of the snake. For example, the "32" in the 32 x 0 configuration means that 32 audio inputs can be connected at the stage to send to the front-of-house mix position. The "0" means that on the there are no audio inputs being sent back to the stage from the front-of-house mix position.

A thirty-two channel system is comprised of four Pro16 Series units, two Pro16 input modules (either the AN-16/i or AN-16/i-M) and two AN-16/o Output Modules. Since the system is modular, you can connect the Pro16 Series units as needed, making any of the configurations mentioned previously available at any time. Simply move and re-patch the units.

## A-Net Expansion

In a thirty-two channel system, the A-Net Expansion jack is used to combine two A-Net data streams into a single stream that can travel down one cable. At the receiving end of the audio network, the A-Net Expansion jack is used again to separate the data into individual 16-channel data streams. The concept used for the Expansion port on A-Net modules is similar to the AN-16SBR System Bridge, described later in this document.

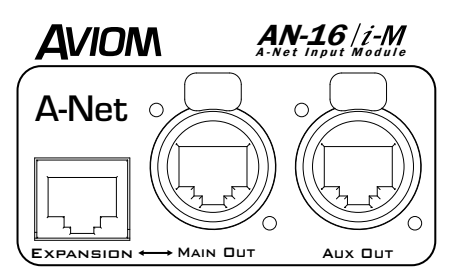

A-Net In, Out, and Expansion connections

Some points to remember about using the A-Net Expansion jacks on the Pro16 input modules and AN-16/o to create a digital snake or audio network:

- When creating a network with four Pro16 Series units, one A-Net Expansion jack will be connected to an A-Net *In* port while the other A-Net Expansion jack will be connected to an A-Net *Out* port.
- The A-Net *Out* jacks on the AN-16/o Output Modules should be empty when only four Pro16 Series units are being used to create a network. These are then available for adding audio splits with additional AN-16/o Output Modules or for connecting to a Personal Monitor Mixing System.
- The cable connecting the two sides of the network (carrying thirty-two channels of audio) should be connected to one A-Net *In* port and one A-Net *Out* port.
- Do not connect Cat-5e cables carrying expanded system data (more than 16 channels) to an A-16D A-Net Distributor or A-16II Personal Mixer.
- The maximum cable length specification of 500 feet (150 meters) applies to the length between an A-Net *In* port and an A-Net *Out* port. Cables used to connect devices via the A-Net Expansion jacks must fall within this maximum distance.
- An A-Net Expansion port is never connected to another A-Net Expansion port.
- The A-Net Main Out on the AN-16/i-M is the only A-Net jack that works with the Expansion port.

*In the following examples, either A-Net input module, the AN-16/i or the AN-16/i-M, can be used. Only one device is shown in the illustrations. They are referred to generically as "Pro16 input modules."*

# 32-Channel Snake

The 32 x 0 configuration has all audio inputs on one side of the system and all audio outputs on the other side. This setup could be used to send 32 mic signals from a stage to a front-of-house (FOH) mixing console, for example.

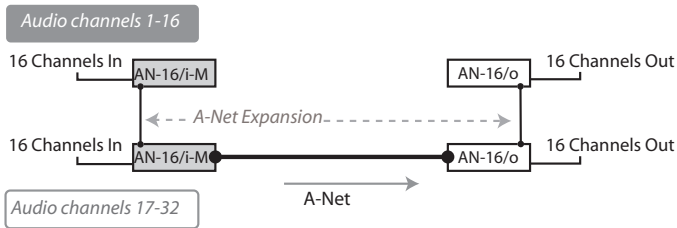

32 channels are sent from a stage to the FOH mix position.

With this configuration, two Pro16 input modules receive thirty-two analog audio (mic- or line-level) signals as inputs. One input module contains channels 1-16, while the other has channels 17-32.

## To configure a 32 x 0 system:

1. Connect the first sixteen mic or line-level audio sources to inputs 1-16 on the first Pro16 input module.
2. Connect the second group of sixteen audio sources to inputs 1-16 on the second input module.
3. Connect a Cat-5e cable from the A-Net Out jack on the first input module to the A-Net Expansion jack on the second input module.
4. Connect a cable from the A-Net Out jack on the second Pro16 input module and run it to the destination where the AN-16/o Output Modules are located, and plug it into the A-Net In jack on the first AN-16/o Output Module.
5. Connect a Cat-5e cable from the A-Net Expansion jack on the first AN-16/o to the A-Net In on the second AN-16/o.
6. Patch the audio outputs from the two AN-16/o Output Modules into the desired destinations.

Either AN-16/i or AN-16/i-M Input Modules can be used as needed for this application.

Remember that the maximum cable length between A-Net devices is 500 feet (150 meters). Always use Cat-5e UTP cable.

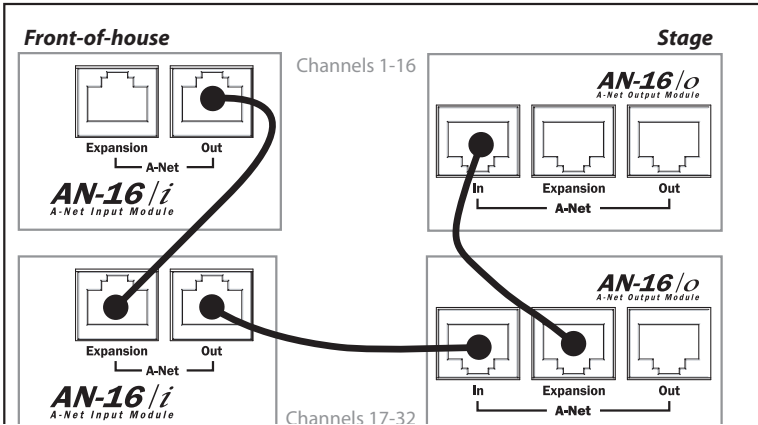

Cat-5 connections for a 32 x 0 system, shown in a live performance setting; use either AN-16/i or AN-16/i-M Input Modules as needed.

## 16 Channels Send by 16 Channels Return

The 16 x 16 configuration has sixteen inputs and sixteen outputs on each side of the digital snake or audio network.

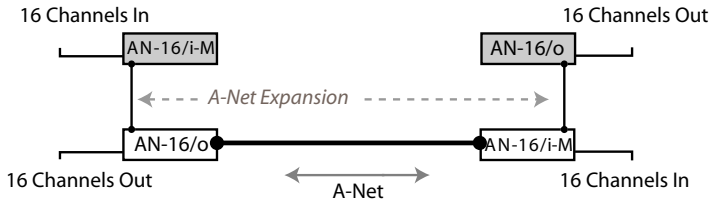

16 channel send and 16 channel return over one Cat-5e cable

Using this configuration, each side of the system has one AN-16/i-M Input Module and one AN-16/o Output Module. Sixteen channels of audio move in each direction over a single Cat-5e cable.

Again, the A-Net Expansion jack is used to combine the A-Net data from two devices for transmission down one Cat-5e cable.

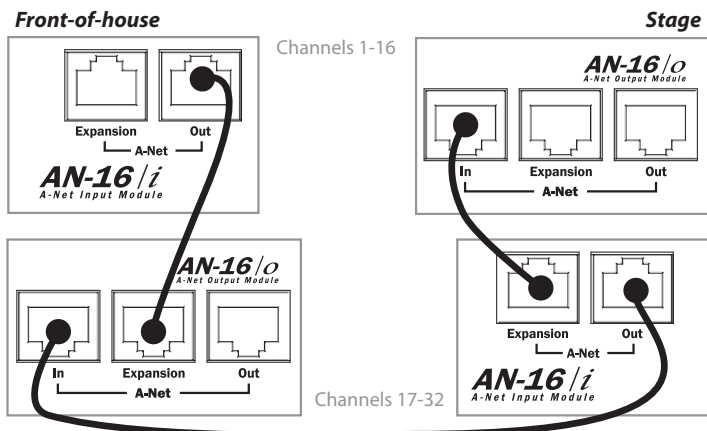

Cabling for a 16 x 16 system; use either AN-16/i or AN-16/i-M Input Modules as needed.

### To configure a 16 x 16 system:

1. Set up one Pro16 input module (AN-16/i or AN-16/i-M) and one AN-16/o on each side of the network. (For example, one set is at the front-of-house mix position, the matching set is placed on the stage.)
2. Connect sixteen mic- or line-level audio sources to inputs 1-16 on the first Pro16 input module.
3. Connect a Cat-5e cable from the A-Net Out jack on the first input module to the A-Net Expansion jack on the first AN-16/o.
4. Plug a Cat-5e cable into the A-Net In jack on the first AN-16/o Output Module. This cable will be used to span up to 500 feet/150 meters between the two sides of the network.
5. Connect the cable from the A-Net In jack in Step 4 to the A-Net Out jack on the second Pro16 input module.
6. Connect the second group of sixteen audio sources to inputs 1-16 on the second Pro16 input module.
7. Connect a Cat-5e cable from the A-Net Expansion jack on the second input module to the A-Net In on the second AN-16/o.
8. Patch the audio outputs from the two AN-16/o Output Modules into the desired destinations.

# Adding More Audio Outputs

As mentioned previously, the A-Net Out jacks on the AN-16/o Output Modules remain available even when creating a bidirectional digital snake or audio network. This allows additional output modules to be added as needed to create digital splits for a variety of audio situations. Any Pro16 Series A-Net compatible product can be added to an A-Net out port. This flexible routing scheme allows you to easily send audio to a variety of different locations, and to include Aviom's Pro16 Monitor Mixing System for performers.

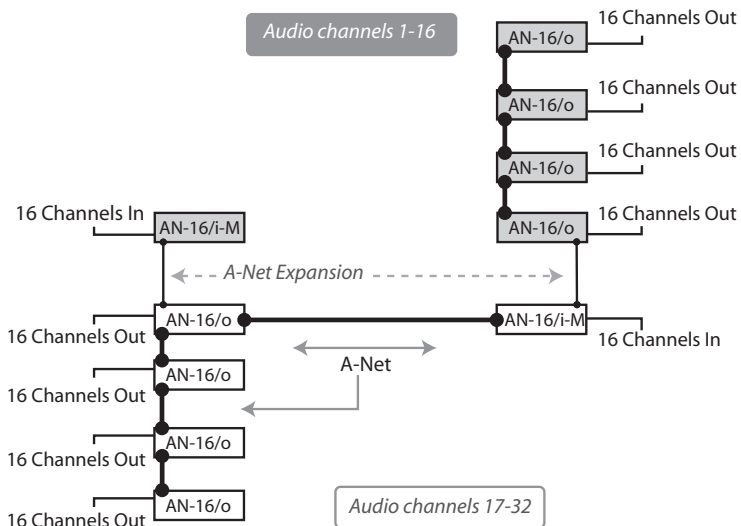

A 16 x 16 system with multiple splits

In this example, a 16 x 16 configuration has been expanded to include three additional AN-16/o Output Modules on each side of the system, creating digital splits. Each AN-16/o is connected via A-Net using a Cat-5e cable. Remember that the cable lengths between each A-Net device can be up to 500 feet (150 meters) long.

## To create an expanded network:

- First start by configuring the network according to your basic needs (either as 32 x 0 or 16 x 16).
- Add additional AN-16/o Output modules by connecting a Cat-5e cable from the A-Net Out port on one of the connected AN-16/o Output Modules to the A-Net In port on



an AN-16/o Output Module that you want to use to expand the system.

- Each additional AN-16/o that you want to add is connected by patching a Cat-5e cable from the A-Net Out jack on the module preceding it to its A-Net In jack.

## Using an A-Net Distributor

While the A-16D and A-16D Pro Distributors are not compatible with the data being generated by the A-Net Expansion ports on the AN-16/i, AN-16/i-M and AN-16/o, you *can* use a distributor to add wiring flexibility to your system.

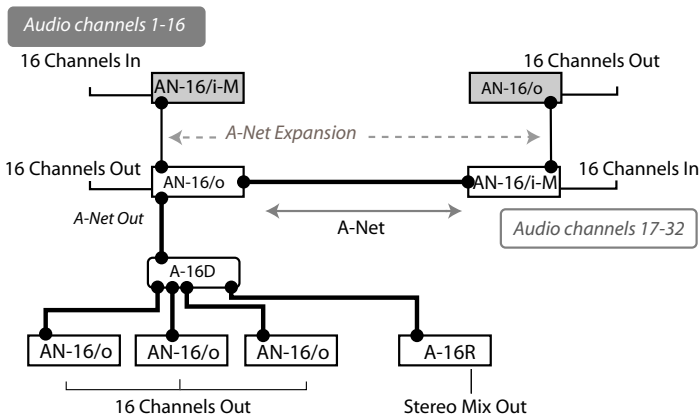

Multiple splits are connected to an A-Net Distributor.

In this diagram, an A-16D Distributor receives A-Net from an AN-16/o Output Module connected to a digital snake configured as 16 x 16. In the example, only audio channels 17-32 are being redistributed to the additional A-Net devices. From the A-16D, up to eight Pro16 A-Net devices can be connected. The diagram shows three AN-16/o Output Modules connected. Each can provide sixteen discrete outputs.

An A-16R rack mounted Personal Mixer is also shown connected to the Distributor as a personal monitor station. The A-16R can be used to mix and monitor the same audio content in stereo. The Cat-5e cable run between the AN-16/o and the A-16D Distributor can be up to 500 feet long, as can the cable from the A-16D to each of the A-Net devices connected to it.

# 64-Channel Systems

When used with the optional AN-16SBR System Bridge, Pro16 input and output modules can create digital snakes of up to sixty-four channels. Up to four input modules and four output modules can be used in a variety of combinations to create a flexible and reconfigurable audio distribution network. Console cards can also be used as input modules.

Aviom's Pro16 products work in modules Systems can be configured as:

- 64 channels send by zero channels return (64 x 0)
- 48 channels send by 16 channels return (48 x 16)
- 32 channels send by 32 channels return (32 x 32)
- 16 channels send by 48 channels return (16 x 48)
- 0 channels send by 64 channels return (0 x 64)

- ✓ **NOTE:** When using the AN-16SBR System Bridge to create a digital snake, the Expansion jacks on the Pro16 input and output modules are not used.

## System Bridge

The AN-16SBR System Bridge is a two-part accessory that takes in up to four A-Net data streams and combines them for transmission. A single Cat-5e cable can then be run to the destination. At the destination, another System Bridge is used to separate the A-Net streams. The four separate A-Net data streams can then be connected to Pro16 A-Net compatible devices as needed.

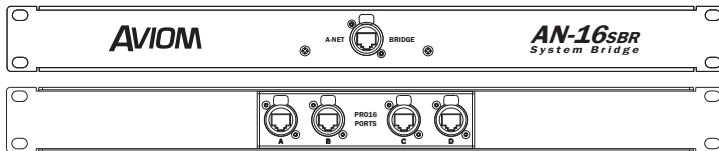

The front and rear panels of the System Bridge

The System Bridge contains four A-Net connector jacks, labeled A, B, C, and D. These accept standard Cat-5e cables from individual Pro16 products.

The Bridge jack of the System Bridge can accept a standard Cat-5e cable or one fitted with the EtherCon connector. The Bridge jack will always connect to another System Bridge's connector of the same name.

## Connecting the System Bridge

Adding a System Bridge to a system is quite simple. Two System Bridges are used to create a network. The four A-Net connectors (labeled A, B, C, and D) on the one side of the network are directly related to the A, B, C, and D connectors on the other side of the network. That is, if you patch an AN-16/i Input Module into port "A" on one side of a System Bridge, an AN-16/o Output Module would be connected to port "A" on the other side of the System Bridge. See the following diagram.

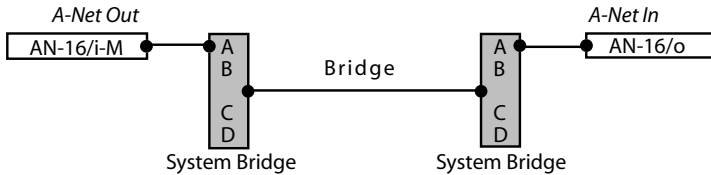

This diagram shows the relationship of the A, B, C, and D ports on the AN-16SB.

A complete network using four units per side follows the same pattern. A Pro16 input module connected to port B on one side of the network connects to an AN-16/o Output Module via port B on the other side of the network. The same goes for ports C and D, as seen in the following diagram.

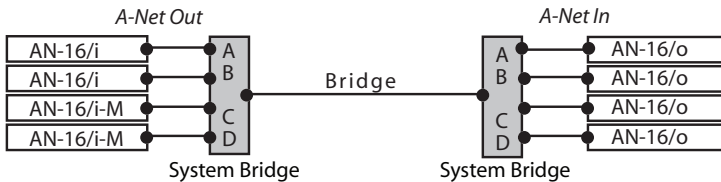

A-Net ports A, B, C, and D shown connected in a 64 x 0 network configuration

### To connect a 64 channel network (64 x 0):

*On the Send side*

1. Connect a Cat-5e cable from the A-Net Out of the first Pro16 input module to port A on the first System Bridge.
2. Repeat this process to connect the A-Net out from the remaining three AN-16/i or AN-16/i-M Input Modules to ports B, C, and D.

*On the Receive side*

3. Connect a Cat-5e cable from port A on the second System Bridge to the A-Net In jack on the first AN-16/o Output Module.

4. Repeat this process to connect ports B, C, and D to the remaining AN-16/o Output Modules.
5. Connect the two sides of the audio network by running a Cat-5e cable (with or without an EtherCon connector) between the Bridge jacks on the System Bridges.

To use other configurations, simply move any pair of input and output modules.

In the following example, the devices connected to port D on the AN-16SBR System Bridge have been swapped to create a 48-channel send x 16-channel return system.

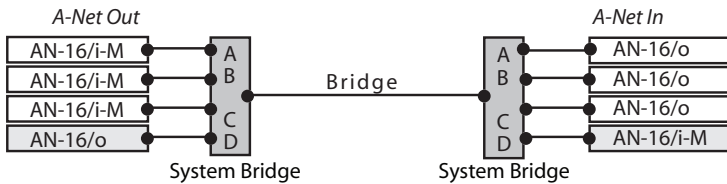

A 48 x 16 system is created by exchanging the units connected to port D on the System Bridge.

Remember, the total cable length between A-Net devices should not exceed 500 feet. Cables used to connect A-Net devices to the System Bridge are *included* in this calculation.

## Configuration Notes

When configuring 64-channel systems that send data in both directions, Aviom suggests the following module combinations. While not mandatory, these suggestions are made to accommodate the standard wiring practices that Ethernet cables use. Some wire pairs in a standard Ethernet Cat-5e cable are not next to each other inside the jacket of the cable. This can account for slightly higher data errors in rare cases.

The configuration recommendations apply to systems configured as 16 x 48 and 32 x 32, not those sending data in only one direction. The module combinations are applicable especially when using long cable runs.

For 16 x 48 (or 48 x 16) configurations, place the three similar In modules together, connected to either ports A, B, and C on the System Bridge or to ports B, C, and D. See the following diagrams.

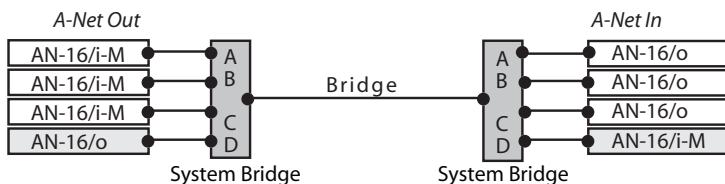

Ports A, B, and C use the same type of module.

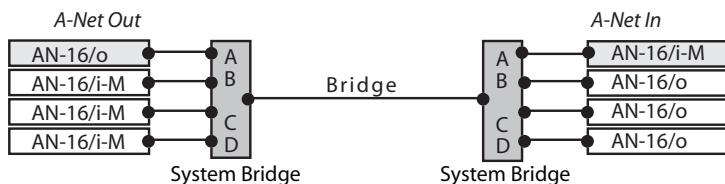

Ports B, C, and D use the same type of module.

For a 32 x 32 configuration, place two similar modules together, connected to ports B, and C on the System Bridge. The modules connected to ports A and D are also similar by doing this configuration. See the following diagram.

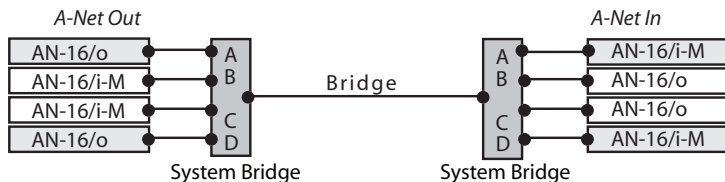

Ports A, and D use the same type of module; ports B and C contain the same type of module.

The total A-Net cable length between devices is limited to 500 feet.

## Expanding a Network

As mentioned in the section on 32-channel systems, any available A-Net Out jack on an A-Net device can be used to expand an existing system. Any number of additional AN-16/o Output Modules can be added, as can any number of A-16II or A-16R Personal Mixers. A-Net Distributors (the A-16D and

the A-16D Pro) can also be used to expand a system.

The following example shows one variation of an expanded system.

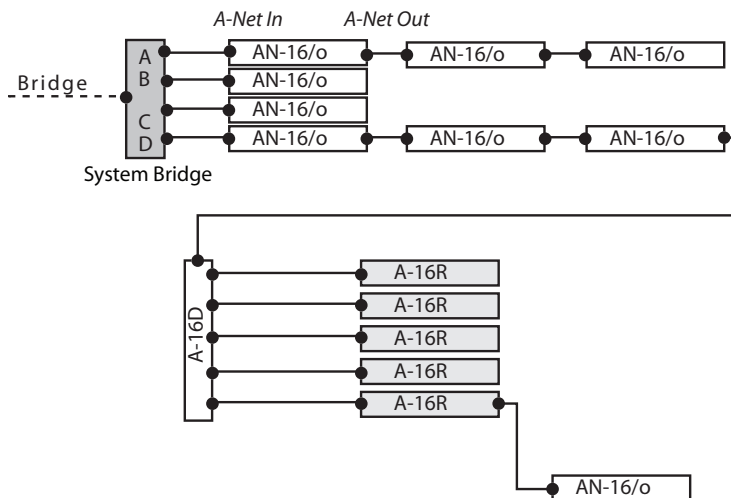

One side of an expanded digital snake system

This example starts as a 64 x 0 configuration (*the input side of the system is not shown in the diagram*). Two of the outputs are expanded. Port A has two AN-16/o Output Modules added. Port D has two Output Modules which then feed an A-16D A-Net Distributor.

The A-16D Distributor connects to five A-16R rack mounted Personal Mixers for use as a monitor system for five musicians performing live. Then, another AN-16/o Output Module is connected via a daisy chain to the last A-16R.

Expansion of a system can continue as your needs require. Any available A-Net Out can be used to connect to the A-Net In on any compatible device.

Each A-Net cable used can be up to 500 feet long, making this system capable of spanning long distances between rooms, floors, etc.

## Using Multiple System Bridges

Expansion of a system can include multiple System Bridges. This allows audio to be fed to different locations as needed. Using multiple System Bridges follows the same connection rules as outlined previously. (Port A on one System Bridge always connects to Port A on another System Bridge, etc.)

System Bridges can also be used to combine A-Net streams from multiple networks in an installation, allowing, for example, ports A and B from Network #1 to be sent along with streams B and C from Network #2 to a third area, creating Network #3.

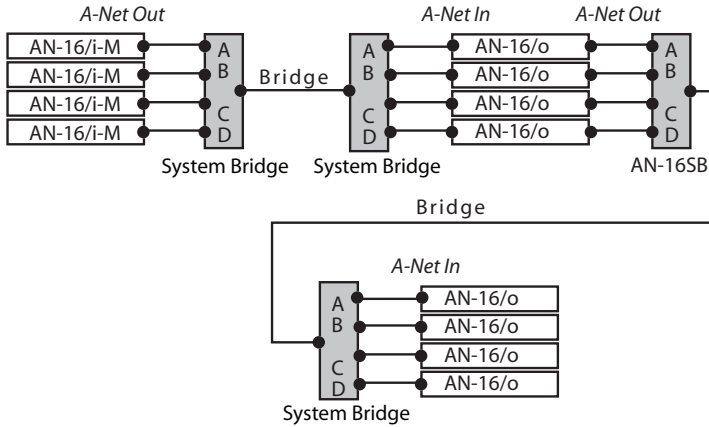

A second set of System Bridges move another digital split of 64 channels of audio over one Cat-5e cable to another destination.

The next example shows a complex network that combines A-Net from two different networks.

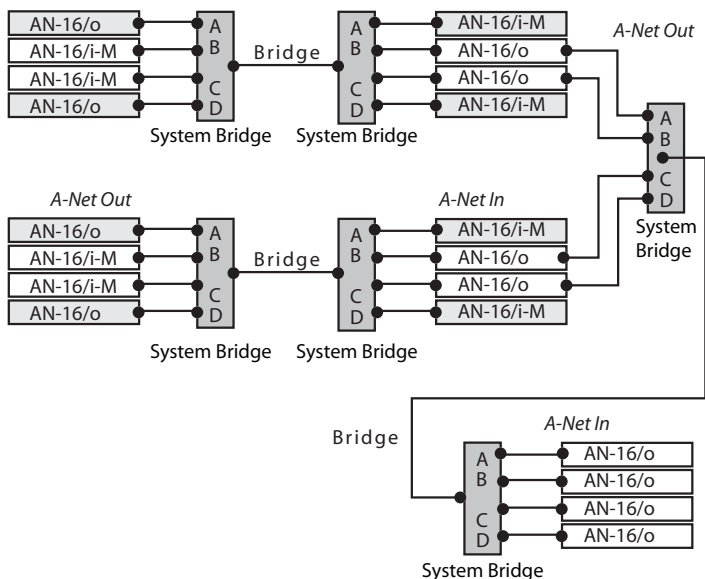

An expanded digital snake using two System Bridges

The output modules connected to ports B and C from the system in the top of the diagram are connected via their A-Net Outs to ports A and B of a second set of System bridges. The system in the middle of the diagram's output modules connected to ports B and C from are connected via their A-Net Outs to ports C and D of the second set of System bridges. This combined Bridge output is sent up to 500 feet to another AN-16SBR where is separated into four A-Net streams. The separate A-Net streams connect to AN-16/o Output Modules.

As with all A-Net compatible devices, any available A-Net Out can be used as a starting point for expansion or splits.



# Specifications

<b>XLR Input (mic/line)</b>	Pin 1: Ground; Pin 2: Audio +; Pin 3: Audio -
<b>TRS Inputs (balanced line level)</b>	Tip: Audio +; Ring: Audio -; Sleeve: Ground
<b>Insert Send and Return</b>	Tip: Audio +; Ring: Audio -; Sleeve: Ground
<b>Audio Thru (XLR)</b>	Pin 1: Ground; Pin 2: Audio +; Pin 3: Audio - Direct coupled passive throughput
<b>Operating Level</b>	+4dBu
<b>Insert Send</b>	Connector: TRS
	Signal: Impedance Balanced
	Nominal level: 0dBu
	Peak Level (A/D clip point): +14dBu
<i>The Send connector is a line output in the signal path post gain, post filter, and post phase controls.</i>	
<b>Insert Return</b>	Connector: TRS
	Signal: Balanced
	Nominal level: 0dBu
	Peak Level (A/D clip point): +14dBu
<i>The Return connector is a line input to the signal path pre A/D conversion.</i>	
<b>Gain Range</b>	Mic: +6dB to +60dB, variable
	Line: -15dB to +36dB, variable
<b>Maximum Input Level</b>	Mic: +14dBu
	Line: +28dBu
<b>Input Impedance</b>	Mic: 2.4k ohms
	Line (TRS): 33k ohms
	Insert Return: 39k ohms
<b>Frequency Response</b>	4Hz-22kHz
<b>Frequency Response (Send jack)</b>	-0.3dB @ 20kHz (all gain settings)
<b>A/D Frequency Response</b>	-0.1dB @ 20kHz (-0.4dB @ 20.0kHz, measured from Mic or Line in)
	-3dB @ 1.5Hz (-3dB @ 2.0Hz, measured from Mic or Line in)

<b>Signal to Noise Ratio (unweighted)</b>	Send jack: -113dB (Gain = minimum)
	A/D: -105dB Reference = +14dBu (A/D clip point)
<b>Mic Input</b>	EIN (Equivalent Input Noise): -128dBu
	(Rs = 150 Ohms, 20kHz BW, Gain = +60dB)
	CMMR (Common Mode Rejection Ratio): 80dB @ 120Hz (Gain = +60dB)
<b>Low Cut Filter</b>	-3dB @ 85Hz, -18 dB per octave
<b>Phantom Power</b>	+48 Volts, per channel
<b>Splitter Output, Mic Thru</b>	Direct coupled passive throughput
<b>A/D converters</b>	24 bit
<b>Digital Outputs</b>	A-Net: 2 (Main and Aux)
	A-Net Expansion: 1
	RJ45 connectors
	Use unshielded Cat-5e UTP (or better) cables
<b>THD +N</b>	< .003%
<b>Crosstalk</b>	-90dB
<b>Bit Error Rate (BER)</b>	10(-12)
<b>EIN (Equivalent Input Noise)</b>	-128dBu (Rs = 150 ohms, 20kHz BW, Gain = +60dB)
<b>CMRR (Common Mode Rejection Ratio)</b>	80dB @ 120Hz (Gain = +60dB)
<b>Power Supply</b>	Internal, universal switching type; standard IEC cable provided
<b>Voltage</b>	100-240VAC, 50-60Hz, 60W
<b>Fuse</b>	250VAC; F4AL
<b>Dimensions</b>	Width: 19 inches (482.6mm)
	Depth: 9.25 inches ( 234.95mm)
	Height: 3U, 5.25 inches (133.35mm)
<b>Weight</b>	12 lb. (5.44 kg)
<i>All Aviom products are designed and manufactured in the USA.</i>	

# Block Diagram

This block diagram shows the signal path as it flows through the AN-16/i-M. Note that the meter section is post insert; this means that the level shown on the meters is influenced by any processor that is connected to the channel insert points.

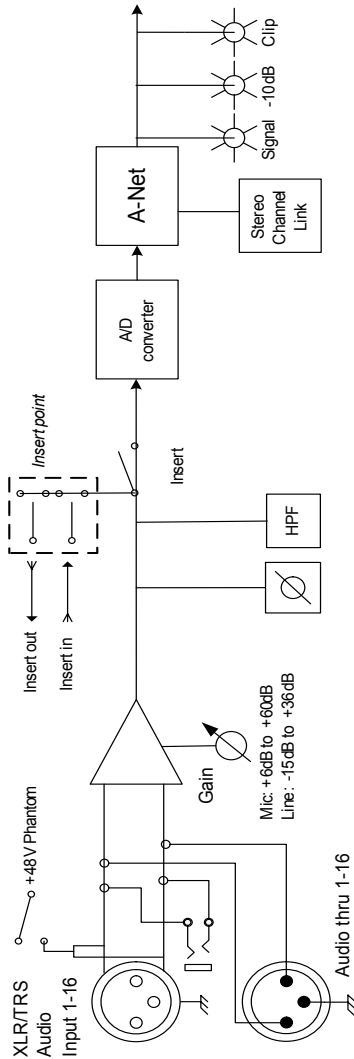



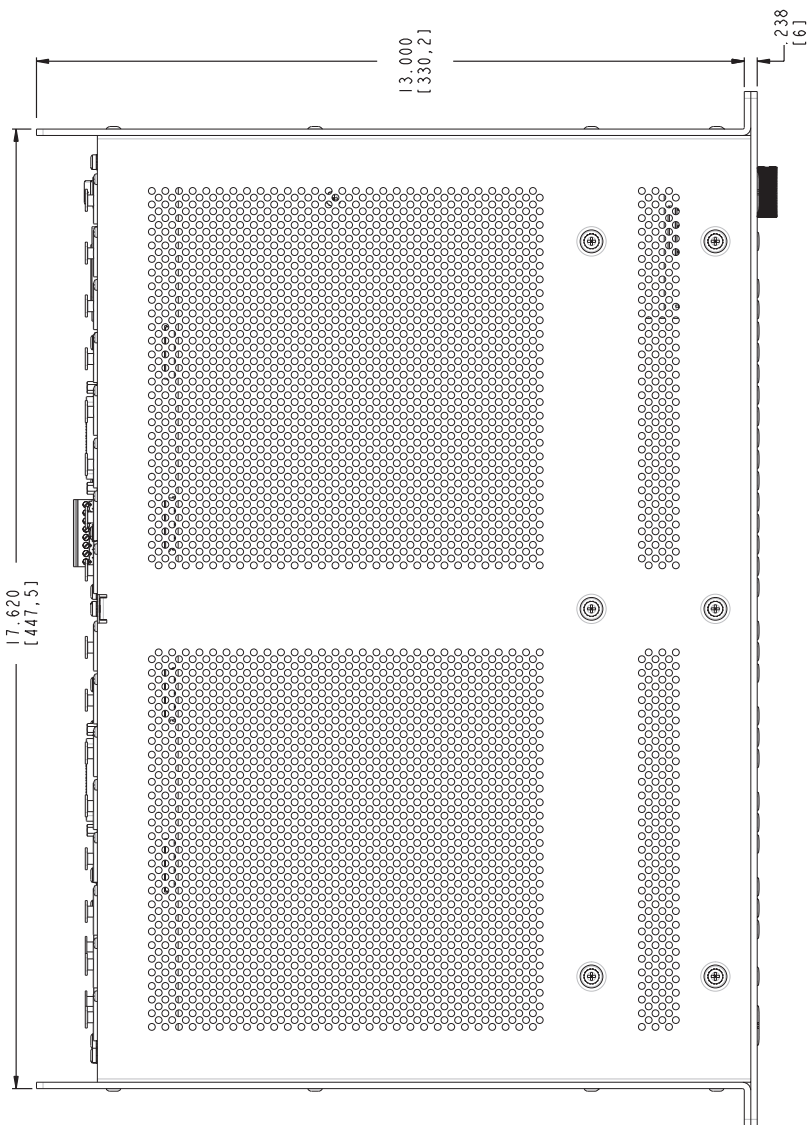

# Index

## Symbols

- 10dB LED 9
- 16-Channel Systems 26
- 32-Channel Systems 21, 27
- +48 volt 9, 11, 14
- 64-Channel Systems 34, 36
- 85Hz Low Cut 9
- 85Hz Low Cut rolloff 14

## A

- A-16CS Control Surface 16
- A-16D 2
- A-16D A-Net Distributor 3
- A-16D Distributor 21, 25, 28, 33, 38
- A-16D Pro 2
- A-16D Pro A-Net Distributor 3
- A-16D Pro Distributor 21, 33
- A-16II 24
- A-16II Personal Mixer 16
- A-16R 16, 24, 33, 38
- AC current 17
- AC Line Conditioning 7
- A/D converter 42
- Adding More Audio Outputs 23, 32
- Adding Personal Mixers 24, 32
- AN-16/i Input Module 34
- AN-16/i-M Front Panel 13
- AN-16/i-M Mic Input Module 1
- AN-16/o Output Module 15–25, 26, 29, 30, 31, 36
- AN-16SBR System Bridge 3, 6, 26, 34, 36
  - using multiple 38
- A-Net 1, 3, 16, 26, 32
  - Bridge 36
- A-Net Active LED 21
- A-Net Aux Out 20
- A-Net Aux Out jack 12
- A-Net connections 17
  - AN-16/i 20
- A-Net Distributor 2, 33
- A-Net Distributors 21
- A-Net Expansion 20, 21, 27, 28, 29, 30
  - AN-16/i 20
- A-Net Expansion jack 12, 27
- A-Net In 38

- A-Net, long distance 25
- A-Net Main Out 12, 20
- A-Net Out 20, 29, 32, 37, 38
  - AN-16/i 20
- A-Net signal repeater 25
- AN-Series 1, 27, 29
- ASI A-Net Systems Interface 4
- Audio Networks 26
  - audio splitter 19
- Aux Out 12
  - A-Net 20

## B

- balanced 41
- Balanced 11
- Balanced signals 18
- bidirectional 32
- block diagram 43
- Bridge 36
  - A-Net 36

## C

- cable length 5, 36
- Cat-5 5, 6
- Cat-5e 2
  - UTP 4
- Cat-6 2, 5
- Category 5 4
- Category 5e 4
- Certifications ii
- Channel Input Jacks 18
- Channel insert Return jack 12
- Channel Inserts 19
- Channel insert Send jack 12
- Channel LEDs 13
- Channel Thru Jacks 19
- Cleaning and Maintenance 8
- Clip LED 9, 11, 14
- combo jack 18
- Compatibility with Pro64 4
- compressor 19
- computer network 4
- condenser mic 19
- Configuration Notes 36

Control Surface 16  
crossover cables 5

## D

daisy-chain 21, 24, 38  
digital snake 15–25, 26  
digital split 22, 23, 32  
digital splits 26  
Direct Line Outputs 19  
Distributor 22, 33, 38

## E

effects device outputs 15  
EtherCon Connector 36  
Ethernet 3  
expanded network 32  
expanding 33, 37  
Expansion 12, 21, 28, 29, 34  
Expansion jack 34  
Extending A-Net 25

## F

fiber optic 25  
FOH 26  
Frequency Response 41  
Front Panel  
AN-16/i 13  
Fuse 11, 42

## G

Gain 9  
Gain knob 14, 18  
Gain Range 14, 41  
Group  
A-16II and A-16R 16  
guitar 18

## I

IEC 11  
IEC power cable 3  
Impedance 41  
inline coupler 6  
Input Jacks 18  
Input Level 41  
Insert 17, 19, 41  
insert Return jack 12  
insert Send jack 12  
Invert 15

## L

LAN  
Local Area Network 3  
LED 9  
LEDs 13  
line-level  
XLR input 18  
line level signals 14  
Line Output 19  
Linking Channels 16  
Link switch 15  
Local Area Network 3  
long distance A-Net 25  
Low Cut Filter 9, 14, 42

## M

Main Out 12  
A-Net 20  
maximum cable length 6, 29  
Maximum Input Level 41  
media converter 25  
Mic Input Module 1  
mic/line 17  
mixer sub-groups 15  
module combinations 36  
Monitor Mixing System 32  
Mono 16

## N

network 4  
Network 37  
networking 4  
Neutrik 8  
Nominal level 41

## O

Operating Level 41  
Output Module 15

## P

Package Contents 3  
Parallel A-Net Routing 22  
parallel connection 21  
passive splitter 19  
Peak Level 41  
permanent installation 5  
Personal Mixer  
A-16II, A-16R 16

- Personal Mixers 32
- Phantom Power 14, 19, 42
- phantom power switch 9
- Phase Invert Switch 9, 11, 15
- polarity 9
- ports 35
- Power Connector 17
- Power LED 10, 16
- Power Supply 17, 42
- Power switch 10
- Pro16 1, 3, 24
- Pro16 Monitor Mixing System 3, 24, 32
- Pro16 Personal Mixer 15
- Pro16 Series 27, 32
- Pro64 4

## R

- Rear Panel description 17
- repeater 25
- Return
  - insert 19
  - Insert 41
- Return jack 12
- RJ45 8
- RJ45 connector 5
- RoHS ii
- Rolloff 9, 14
- router 4
- rumble filter 14

## S

- Send 19
  - Insert 41
- Send jack 12
- send/return 19
- series connection 21
- Signal LED 14
- Signal present LED 9
- signal repeater 25
- Signal to Noise Ratio 42
- snake 15–25, 20, 26, 27
- split 23, 26, 32, 33
- Splitter 19, 42
- stand-alone mic preamp 19
- stereo channel 15
- stereo input 15, 16
- Stereo Link 9, 15, 16
- System Bridge 3, 21, 26, 27, 34, 35, 38, 39
  - using multiple 38

## T

- Thru jack 11, 19
- Tip, Ring, and Sleeve 18
- TRS 18, 19, 41
- TRS balanced input 14
- TRS line-level input 11

## U

- unbalanced 18
- Unshielded Twisted Pair 4
- UPS 4, 7
- Using Multiple System Bridges 38
- UTP 4
- UTP cable 29

## V

- Voltage 42

## X

- XLR 41
  - In/Thru 11
- XLR input 14, 18



# Warranty Registration

*Please take a moment to fill in this warranty registration form. Return it to Aviom via mail or fax. All information will be kept confidential.*

Model Number \_\_\_\_\_ Product Serial Number \_\_\_\_\_

Model Number \_\_\_\_\_ Product Serial Number \_\_\_\_\_

Model Number \_\_\_\_\_ Product Serial Number \_\_\_\_\_

Model Number \_\_\_\_\_ Product Serial Number \_\_\_\_\_

Date Purchased \_\_\_\_\_

Dealer Name \_\_\_\_\_

Dealer Location \_\_\_\_\_

\_\_\_\_\_

Your Name \_\_\_\_\_

Address \_\_\_\_\_

Address \_\_\_\_\_

City \_\_\_\_\_

State/Province \_\_\_\_\_

Zip/Postal Code \_\_\_\_\_

Country \_\_\_\_\_

Email Address \_\_\_\_\_

Fax this form to Aviom at +1 610-738-9950

**AVIOM<sup>®</sup>**

**1157 Phoenixville Pike, Suite 201 • West Chester, PA 19380**  
**Voice: +1 610.738.9005 • Fax: +1 610.738.9950 • [www.Aviom.com](http://www.Aviom.com)**